

# SPECIFICATION FOR LCD MODULE

Model No. WG12864E

<b>Prepared by:</b>	<b>Date:</b>
<b>Checked by :</b>	<b>Date:</b>
<b>Verified by :</b>	<b>Date:</b>
<b>Approved by:</b>	<b>Date:</b>

**WINCOM ELECTRONICS CO., LTD**

## REVISION RECORD

<b>Date</b>	<b>Ref. Page</b>	<b>Revision No.</b>	<b>Revision Items</b>	<b>Check &amp; Approval</b>

## 1 General Specifications:

- 1.1 Display type: STN
- 1.2 Display color\*<sup>1</sup>:
  - Display color: Blue-Black
  - Background\*<sup>2</sup>: Grey
- 1.3 Polarizer mode: Transflective/Positive
- 1.4 Viewing Angle: 6:00
- 1.5 Driving Method: 1/64 Duty 1/9 Bias
- 1.6 Lcd operating voltage: 8.5V
- 1.7 Vdd: 3.0V OR 5.0 V
- 1.8 Backlight: EL
- 1.9 Controller: KS0107
- 1.10 Data Transfer: 8 Bit Parallel
- 1.11 Operating Temperature: -20----+60°C
  - Storage Temperature: -30----+70°C
- 1.12 Outline Dimensions: Refer to outline drawing on next page
- 1.13 Dot Matrix: 128 X 64 Dots
- 1.14 Dot Size: 0.28X0.35(mm)
- 1.15 Dot Pitch: 0.32X0.39 (mm)
- 1.16 Weight: 60g

\*<sup>1</sup> Color tone is slightly changed by temperature and driving voltage.

\*<sup>2</sup> Color tone will be changed by backlight.

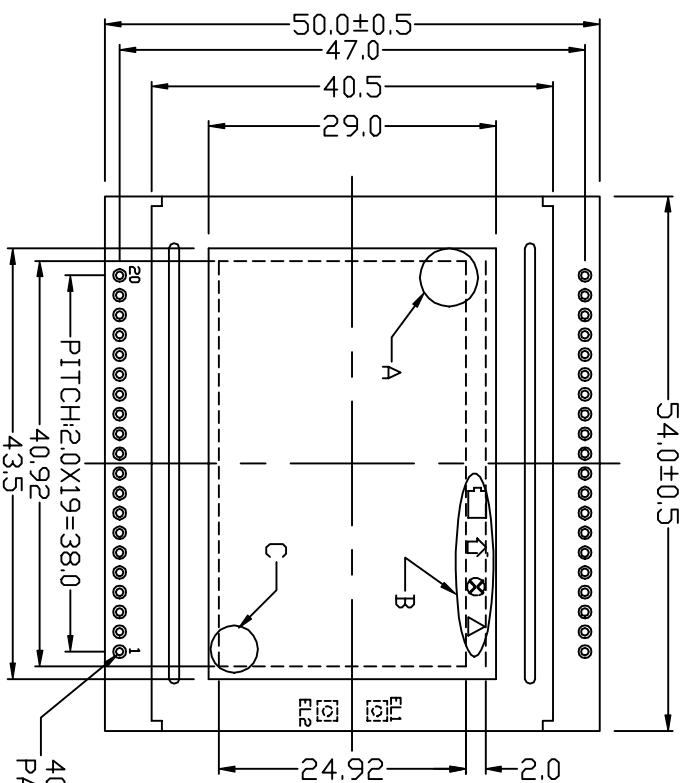

1	2	3	4	5	6	7	8	9	10	11	12	13	14	15	16	17	18	19	20	
V <sub>SS</sub>	V <sub>DD</sub>	V <sub>0</sub>	D <sub>1</sub>	R <sub>1</sub>	K <sub>1</sub>	V <sub>1</sub>	E	DB0	DB1	DB2	DB3	DB4	DB5	DB6	DB7	CS1	CS2	RST	V <sub>EE</sub>	EL1

- NOTES:
- 1.DISPLAY TYPE: STN/GREY  
 2.VIEWING DIRECTION: 6:00  
 3.POLARIZER MODE: TRANSPARENT/POSITIVE  
 4.OPERATING TEMP: -20°C--+60°C  
 5.STORAGE TEMP: -30°C--+70°C  
 6.LCD OPERATING VOLTAGE:8.5V  
 7.DRIVE METHOD: 1/64 DUTY 1/9 BIAS  
 8.BACK LIGHT TYPE: EL  
 9.UNMARKED TOLERANCE: ±0.3mm  
 10.LOGIC VOLTAGE: 3.0V  
 11.CONTROLLER: HCD61203U  
 12.BEZEL IS TO BE COATING WITH ZINE(WHITE)

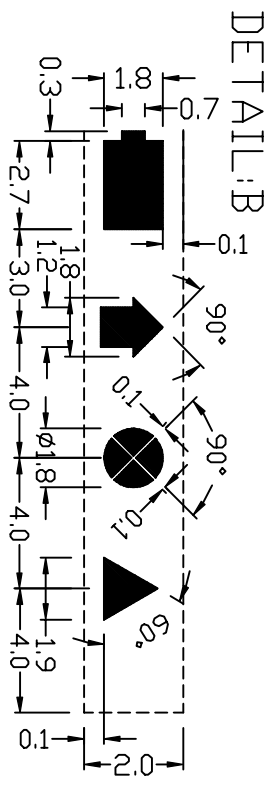
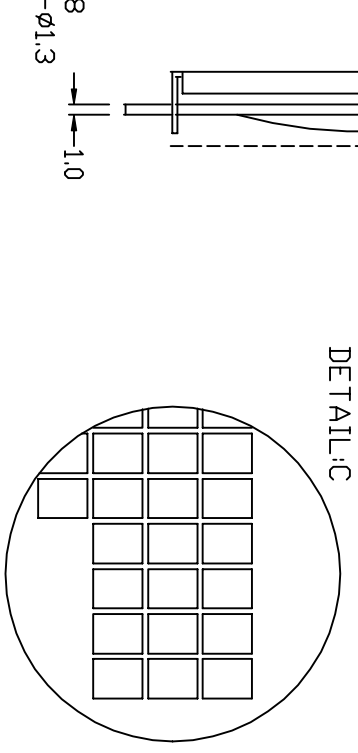
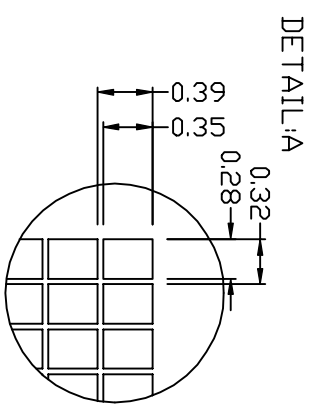
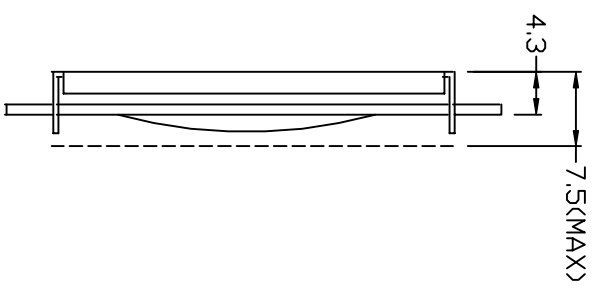

TM1285

# Wincom Electronics Number System

**W C XXXXXXXA 0 T F P L Y N C -06**

1 2 3 4 5 6 7 8 9 10 11 12 13

1. WINCOM

2. C — Character module                      G — Graphic module

3. Graphic module: 5—6digitals indicating number of columns and rows.

Character module: 4 digitals indicating number of characters and lines.

4. PCB version: PCB dimension and interface position, mark starting from AÖ.

5. PCB lay out version: Marks from “0”.

6. LCD type:

T : TN LCD                      S : STN LCD                      H : HTN LCD

F : single layer B/W FSTN                      D : Double layer B/W FSTN

7. Display Type:

R : Reflective    F: Transflective    T: Transmissive

8. Color mode

TN : P Positive    N Negative

STN : Y Yellow green    G Grey                      B Blue

FSTN(F):P Positive    N - Negative    FSTN(D) : P Positive    N Negative

9. BACKLIGHT MODE

L LED                      N Without B/L    E EL                      C CCFL

10. Backlight color

Y - yellow green    B - blue    A - amber    R - red    W – white

N – without backlight

11. Operating temperature option

N : 0°C---+50°C                      HT : -20°C---+70°C

EHT : -30°C---+80°C                      O : other

12. IC packing

P : package type SMD                      C : COB

N : without IC                      G : COG                      T : TCP

13. Viewing direction

03--- 3 O'clock                      06--- 6 O'clock                      09--- 9 O'clock                      12--- 12 O'clock

## 5 Absolute Maximum Ratings

Item	Symbol	Min.	Max.	Unit	Remark
Power Supply Voltage	$V_{DD}-V_{SS}$	-0.3	6.0	V	
LCD Driving Voltage	$V_{LCD}$	-	25.0		
Operating Temperature Range	$T_{OP}$	-20	+60	°C	No Condensation
Storage Temperature Range	$T_{ST}$	-30	+70		

## 6 Electrical Specifications and Instruction Code

### 6.1 Electrical characteristics

Item	Symbol	Min.	Typ.	Max.	Unit	
Supply Voltage (Logic)	$V_{DD}-V_{SS}$	2.7	3.0	5.5	V	
Supply Voltage (LCD Drive)	$V_{LCD}$	-	8.5	-	V	
Input Signal Voltage	High	$V_{IH}$ ( $V_{DD}=3.0$ )	$0.8V_{DD}$	-	$V_{DD}+0.3$	V
	Low	$V_{IL}$ ( $V_{DD}=3.0$ )	0	-	$0.2 V_{DD}$	V
Supply current (Logic)	$I_{DD}$	-	6.0	-	mA	
Supply current (LCD Drive)	$I_{EE}$	-	1.9	-	mA	
Supply current (LED Drive)	$I_{LED}$	-	-	2.5	mA	

## 6.2 Interface Signals

Pin No.	Symbol	Level	Description
1	VSS	0V	Ground
2	VDD	3.0V	Power supply voltage for logic and LCD(+)
3	V0	-5.5V	Power supply voltage for LCD(-)
4	D/I	H/L	Selects registers
5	R/ $\overline{W}$	H/L	Selects read or write
6	E	H/L	Starts data read/write
7	DB0	H/L	Data bit0
8	DB1	H/L	Data bit1
9	DB2	H/L	Data bit2
10	DB3	H/L	Data bit3
11	DB4	H/L	Data bit4
12	DB5	H/L	Data bit5
13	DB6	H/L	Data bit6
14	DB7	H/L	Data bit7
15	CS1	H/L	When CS1=1,CS2=0 select the left half display
16	CS2	H/L	
17	$\overline{RST}$	H/L	Reset signal
18	Vee	-10V	DC-DC output
19	EL1	3.0 V	
20	EL2	0	NC



### 6.3 Interface Timing Chart

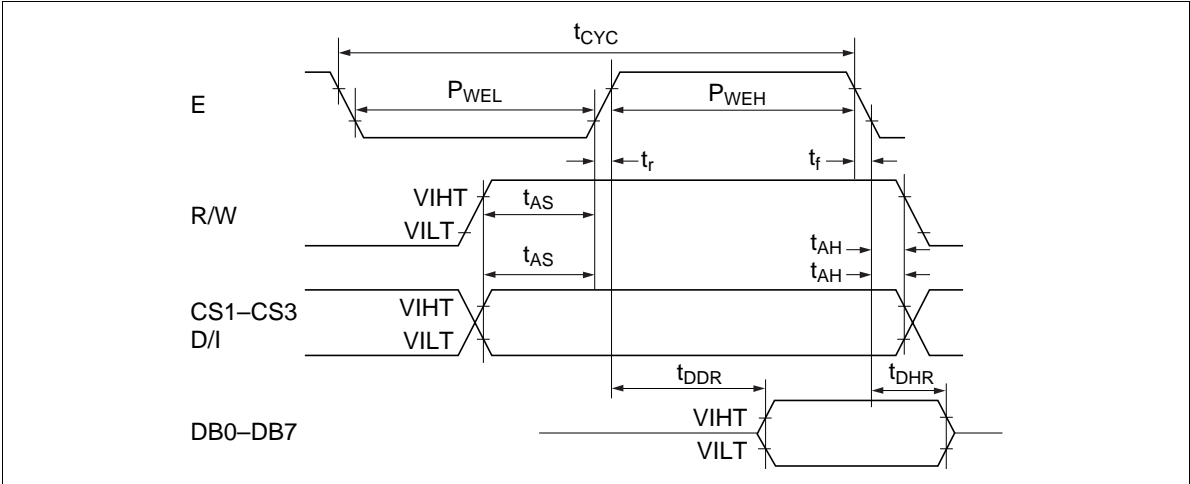

CPU Read Timing

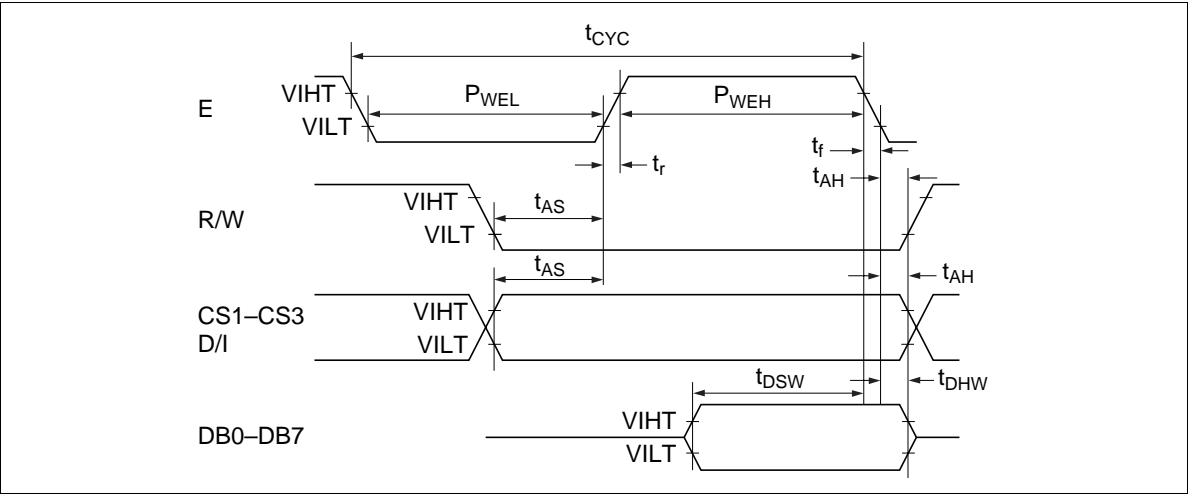

CPU Write Timing

## AC Characteristics

**MPU Interface (GND = 0V, V<sub>CC</sub> = 2.7 to 5.5V, Ta = -30 to +75°C)\***

<b>Item</b>	<b>Symbol</b>	<b>Min</b>	<b>Typ</b>	<b>Max</b>	<b>Unit</b>
E cycle time	t <sub>CYC</sub>	1000	—	—	ns
E high level width	P <sub>WEH</sub>	450	—	—	ns
E low level width	P <sub>WEL</sub>	450	—	—	ns
E rise time	t <sub>r</sub>	—	—	25	ns
E fall time	t <sub>f</sub>	—	—	25	ns
Address setup time	t <sub>AS</sub>	140	—	—	ns
Address hold time	t <sub>AH</sub>	10	—	—	ns
Data setup time	t <sub>DSW</sub>	200	—	—	ns
Data delay time	t <sub>DDR</sub>	—	—	320	ns
Data hold time (write)	t <sub>DHW</sub>	10	—	—	ns
Data hold time (read)	t <sub>DHR</sub>	20	—	—	ns

## 6.4 Instruction Code

Instructions	Code														Functions
	R/W	D/I	DB7	DB6	DB5	DB4	DB3	DB2	DB1	DB0					
Display on/off	0	0	0	0	1	1	1	1	1	1	1	0	1/0		Controls display on/off. RAM data and internal status are not affected. 1: on, 0: off.
Display start line	0	0	1	1	Display start line (0–63)										Specifies the RAM line displayed at the top of the screen.
Set page (X address)	0	0	1	0	1	1	1	1	Page (0–7)						Sets the page (X address) of RAM at the page (X address) register.
Set Y address	0	0	0	0	1	Y address (0–63)									Sets the Y address in the Y address counter.
Status read	1	0	Busy	0	ON/OFF	Reset	0	0	0	0	0	0			Reads the status. RESET 1: Reset 0: Normal ON/OFF 1: Display off 0: Display on Busy 1: Internal operation 0: Ready
Write display data	0	1	Write data												Writes data DB0 (LSB) to DB7 (MSB) on the data bus into display RAM.
Read display data	1	1	Read data												Reads data DB0 (LSB) to DB7 (MSB) from the display RAM to the data bus.

Note: Busy time varies with the frequency ( $f_{CLK}$ ) of  $\phi_1$ , and  $\phi_2$ .  
 $(1/f_{CLK} \leq T_{BUSY} \leq 3/f_{CLK})$

## 7 Optical Characteristics

### 7.1 Optical Characteristics

Ta=25°C

Item	Symbol	Condition	Min.	Typ.	Max.	Unit	
Viewing Angle	$\theta_x$	$C_r \geq 2$	$\theta_y = 0^\circ$	-30	--	20	Deg
	$\theta_y$						
Contrast Ratio	$C_r$	$\theta_x = 0^\circ$ $\theta_y = 0^\circ$	3.0	-	-		
Response Time	Turn on	$T_{on}$	$\theta_x = 0^\circ$ $\theta_y = 0^\circ$	-	-	300	ms
	Turn off	$T_{off}$		-	-	300	

## 7.2 Definition of Optical Characteristics

### 7.2.1 Definition of Viewing Angle

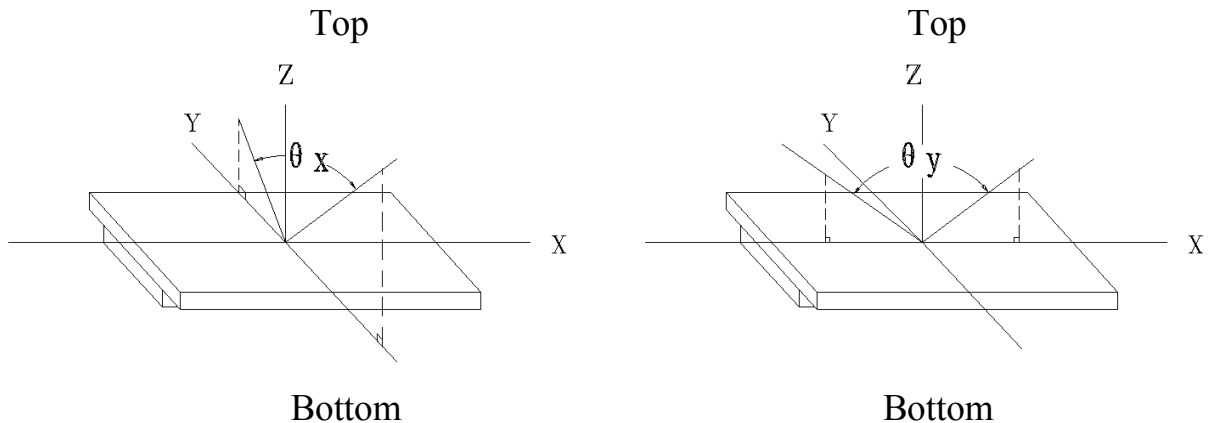

### 7.2.2 Definition of Contrast Ratio

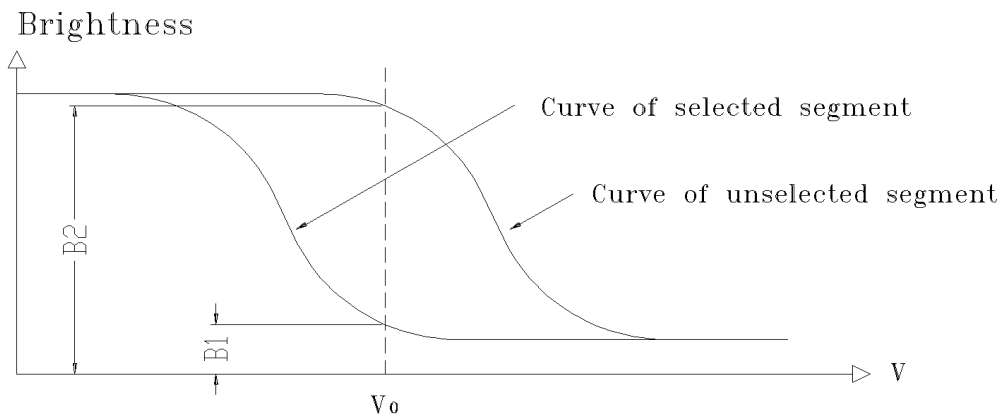

$$\text{Contrast Ratio} = B2/B1 = \frac{\text{unselected state brightness}}{\text{selected state brightness}}$$

Measuring Conditions:

- 1) Ambient Temperature: 25°C ;
- 2) Frame frequency: 70Hz

### 7.2.3 Definition of Response time

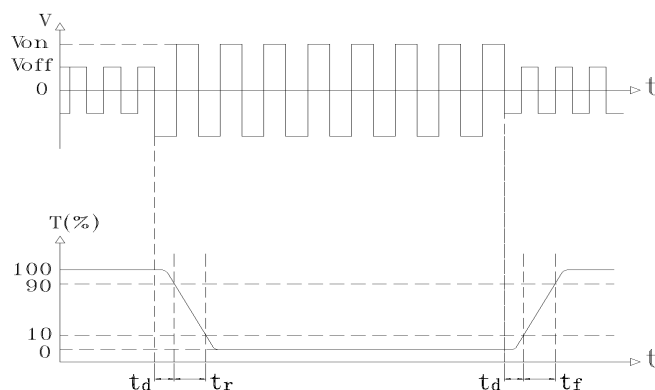

Turn on time:  $t_{on} = t_d + t_r$       Turn off time:  $t_{off} = t_d + t_f$

Measuring Condition:

- 1) Operating Voltage: 8.5V
- 2) Frame frequency: 70Hz

## 8 Reliability

### 8.1 Content of Reliability Test

Ta=25°C

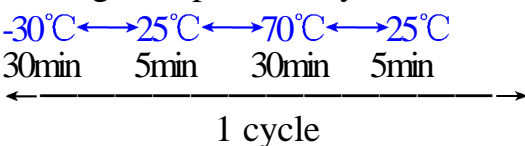
No.	Test Item	Content of Test	Test condition
1	High Temperature Storage	Endurance test applying the high storage temperature for a long time	70°C 240H
2	Low Temperature Storage	Endurance test applying the low storage temperature for a long time	-30°C 240H
3	High Temperature Operation	Endurance test applying the electric stress (voltage & current) and the thermal stress to the element for a long time	60°C 240H
4	Low Temperature Operation	Endurance test applying the electric stress under low temperature for a long time	-20°C 240H
5	High Temperature /Humidity Storage	Endurance test applying the high temperature and high humidity storage for a long time	60°C 95%RH 240H
6	Temperature Cycle	Endurance test applying the low and high temperature cycle 	-30°C/70°C 10 cycles
7	Vibration Test (package state)	Endurance test applying the vibration during transportation	10Hz~500Hz, 100m/s <sup>2</sup> , 120min
8	Shock Test (package state)	Endurance test applying the shock during transportation	Half- sine wave, 300m/s <sup>2</sup> , 18ms
9	Atmospheric Pressure Test	Endurance test applying the atmospheric pressure during transportation by air	25kPa 16H

## 8.2 Failure Judgment Criterion

Criterion Item	Test Item No.									Failure Judgement Criterion
	1	2	3	4	5	6	7	8	9	
Basic Specification	√	√	√	√	√	√	√	√	√	Out of the basic Specification
Electrical specification	√	√	√	√	√					Out of the electrical specification
Mechanical Specification							√	√		Out of the mechanical specification
Optical Characteristic	√	√	√	√	√	√			√	Out of the optical specification
Note	For test item refer to 8.1									
Remark	Basic specification = Optical specification + Mechanical specification									

## 9 QUALITY LEVEL

Examination or Test	At $T_a=25^\circ\text{C}$ (unless otherwise stated)	Inspection				
		Min.	Max.	Unit	IL	AQL
External Visual Inspection	Under normal illumination and eyesight condition, the distance between eyes and LCD is 25cm.	See Appendix A			II	Major 1.0 Minor 2.5
Display Defects	Under normal illumination and eyesight condition, display on inspection.	See Appendix B			II	Major 1.0 Minor 2.5
Note: Major defects: Open segment or common, Short, Serious damages, Leakage Miner defects: Others Sampling standard conforms to GB2828						



## **10 Precautions for Use of LCD Modules**

### 10.1 Handling Precautions

10.1.1 The display panel is made of glass. Do not subject it to a mechanical shock by dropping it from a high place, etc.

10.1.2 If the display panel is damaged and the liquid crystal substance inside it leaks out, be sure not to get any in your mouth, if the substance comes into contact with your skin or clothes, promptly wash it off using soap and water.

10.1.3 Do not apply excessive force to the display surface or the adjoining areas since this may cause the color tone to vary.

10.1.4 The polarizer covering the display surface of the LCD module is soft and easily scratched. Handle this polarizer carefully.

10.1.5 If the display surface is contaminated, breathe on the surface and gently wipe it with a soft dry cloth. If still not completely clear, moisten cloth with one of the following solvents:

- Isopropyl alcohol
- Ethyl alcohol

Solvents other than those mentioned above may damage the polarizer. Especially, do not use the following:

- Water
- Ketone
- Aromatic solvents

10.1.6 Do not attempt to disassemble the LCD Module.

10.1.7 If the logic circuit power is off, do not apply the input signals.

10.1.8 To prevent destruction of the elements by static electricity, be careful to maintain an optimum work environment.

- a. Be sure to ground the body when handling the LCD Modules.
- b. Tools required for assembly, such as soldering irons, must be properly ground.
- c. To reduce the amount of static electricity generated, do not conduct assembly and other work under dry conditions.
- d. The LCD Module is coated with a film to protect the display surface. Be care when peeling off this protective film since static electricity may be generated.

## 10.2 Storage precautions

10.2.1 When storing the LCD modules, avoid exposure to direct sunlight or to the light of fluorescent lamps.

10.2.2 The LCD modules should be stored under the storage temperature range.

If the LCD modules will be stored for a long time, the recommend condition is:

Temperature :  $0^{\circ}\text{C} \sim 40^{\circ}\text{C}$

Relatively humidity:  $\leq 80\%$

10.2.3 The LCD modules should be stored in the room without acid, alkali and harmful gas.

10.3 The LCD modules should be no falling and violent shocking during transportation, and also should avoid excessive press, water, damp and sunshine.

## Appendix A

### Inspection items and criteria for appearance defects

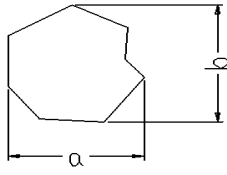
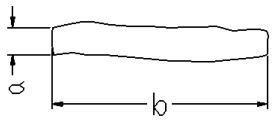
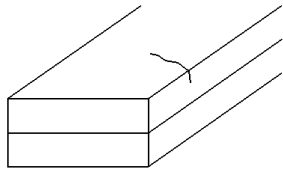
Items	Contents	Criteria		
Leakage		Not permitted		
Rainbow		According to the limit specimen		
Polarizer	Wrong polarizer attachment	Not permitted		
	Bubble between polarizer and glass	Not counted	Max. 3 defects allowed	
		$\phi < 0.3\text{mm}$	$0.3\text{mm} \leq \phi \leq 0.5\text{mm}$	
	Scratches of polarizer	According to the limit specimen		
Black spot (in viewing area)		Not counted	Max. 3 spots allowed	Max. 3 spots (lines) allowed
		$X < 0.2\text{mm}$	$0.2\text{mm} \leq X \leq 0.5\text{mm}$	
		$X = (a+b)/2$		
Black line (in viewing area)		Not counted	Max. 3 lines allowed	
		$a < 0.02\text{mm}$	$0.02\text{mm} \leq a \leq 0.05\text{mm}$ $b \leq 2.0\text{mm}$	
Progressive cracks		Not permitted		

## Appendix B

### Inspection items and criteria for display defects

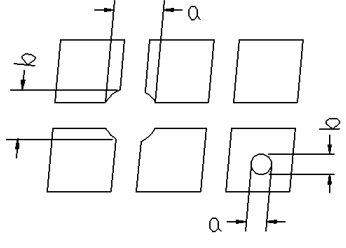
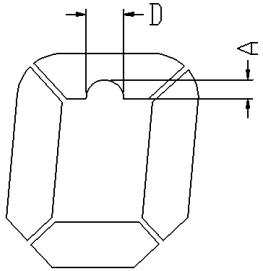
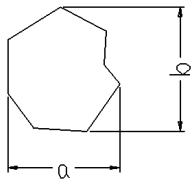
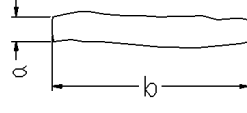
Items	Contents	Criteria			
Open segment or open common		Not permitted			
Short		Not permitted			
Wrong viewing angle		Not permitted			
Contrast ratio uneven		According to the limit specimen			
Crosstalk		According to the limit specimen			
Pin holes and cracks in segment (DOT)		Not counted	Max.3 dots allowed		Max.3 dots allowed
		$X < 0.1\text{mm}$	$0.1\text{mm} \leq X \leq 0.2\text{mm}$		
		$X = (a+b)/2$			
		Not counted	Max.2 dots allowed		
$A < 0.1\text{mm}$		$0.1\text{mm} \leq A \leq 0.2\text{mm}$ $D < 0.25\text{mm}$			
Black spot (in viewing area)		Not counted	Max.3 spots allowed		Max.3 spots (lines) allowed
		$X < 0.1\text{mm}$	$0.1\text{mm} \leq X \leq 0.2\text{mm}$		
		$X = (a+b)/2$			
Black line (in viewing area)		Not counted	Max.3 lines allowed		Max.3 spots (lines) allowed
		$a < 0.02\text{mm}$	$0.02\text{mm} \leq a \leq 0.05\text{mm}$ $b \leq 0.5\text{mm}$		

## Appendix B

### Inspection items and criteria for display defects (continued)

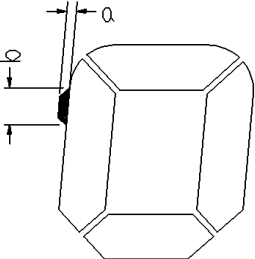
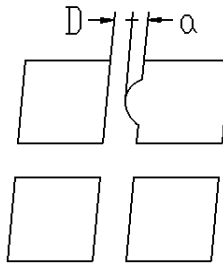
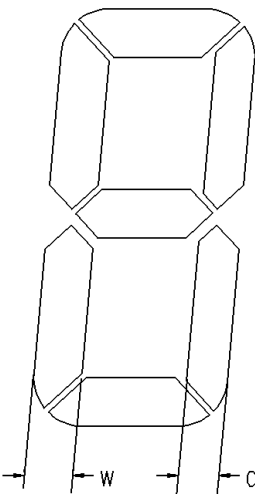
Items	Content	Criteria				
Transformation of segment		Not counted	Max. 2 defects allowed	Max.3 defects allowed		
		$x < 0.1\text{mm}$	$0.1\text{mm} \leq x \leq 0.2\text{mm}$			
		$x = (a+b)/2$				
		Not counted	Max. 1 defects allowed			
		$a < 0.1\text{mm}$	$0.1\text{mm} \leq a \leq 0.2\text{mm}$ $D > 0$			
		Max.2 defects allowed $0.8W \leq a \leq 1.2W$  $a = \text{measured value of width}$ $W = \text{nominal value of width}$				