

CIMCO SOFTWARE

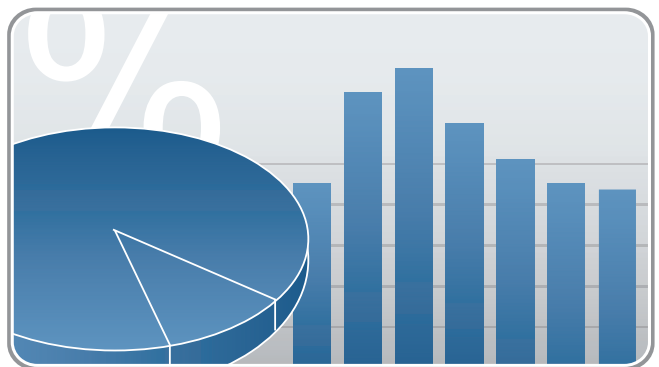

CIMCO Edit

The Professional CNC program editor

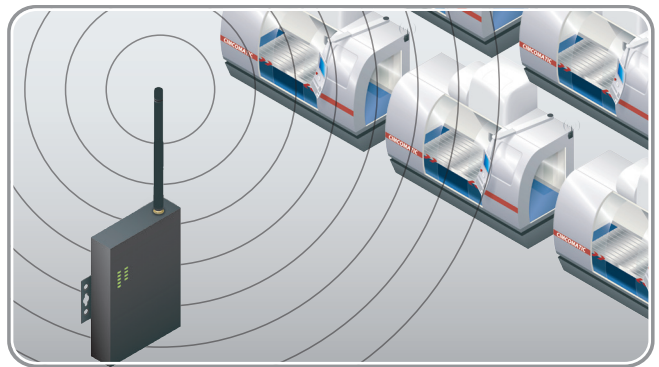
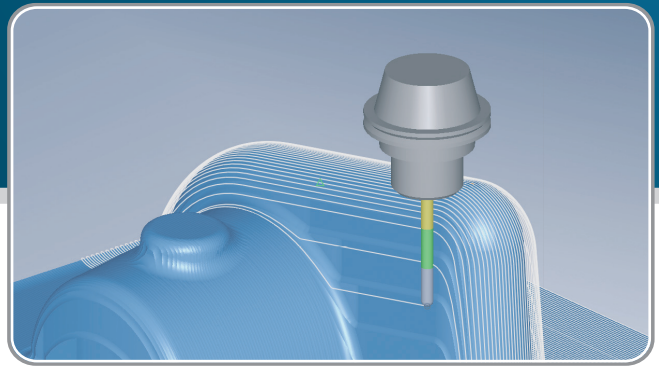
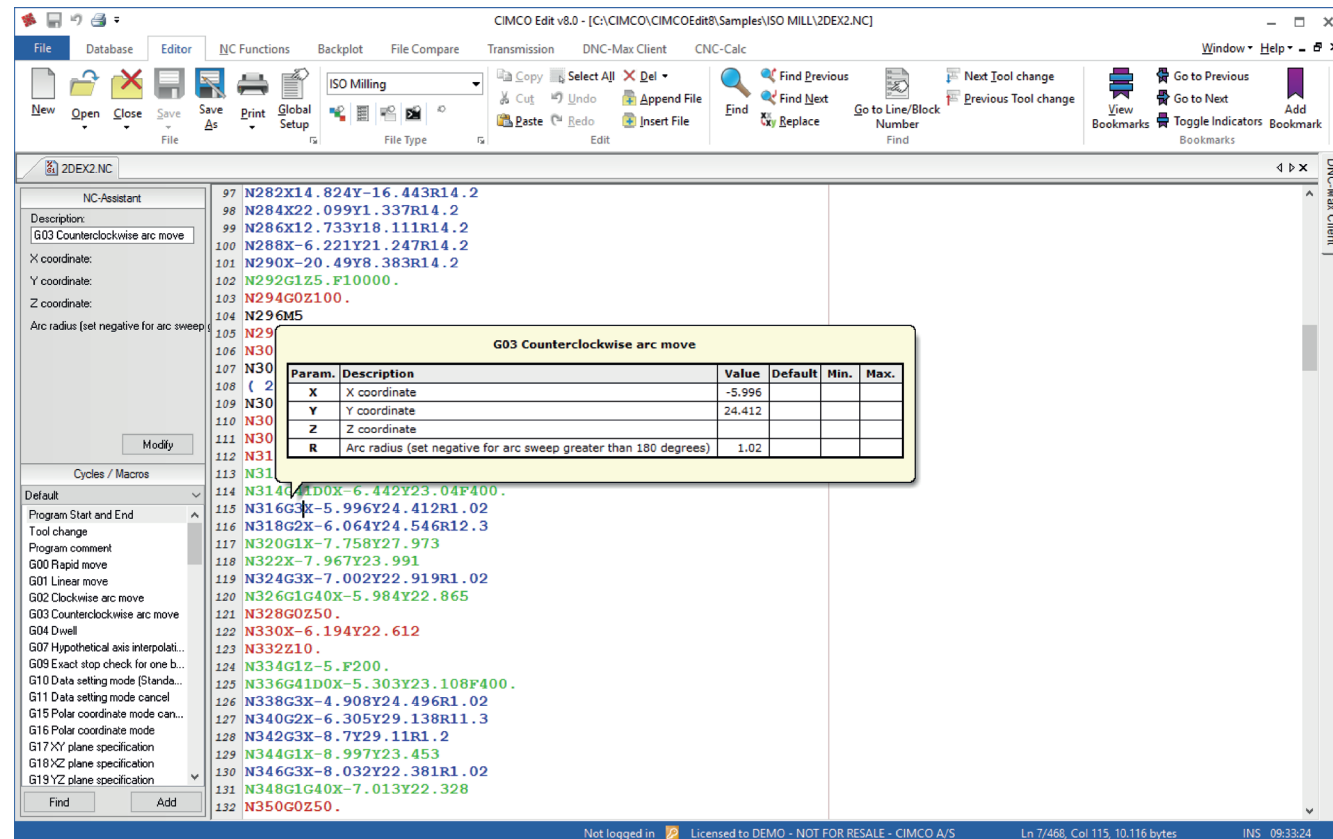

The Professional CNC program editor

As a CNC programmer or machinist on the shop floor responsible for creating or editing CNC programs you need a professional tool that is fast and flexible.

CIMCO Edit is the most popular CNC program editor on the market. With over 100,000 licenses distributed, CIMCO Edit is the editor-of-choice for professionals who demand a full-featured and reliable, cost-effective professional editing and communication tool. CIMCO Edit provides a comprehensive set of editing tools that meet the demands of modern CNC program editing.

CIMCO Edit includes CNC code specific options such as line numbering/renumbering, character handling, and XYZ range finder. It also features math functions including basic math, rotate, mirror, tool compensation, and translate. CIMCO Edit offers all the functions expected from an editor including drag-and-drop text editing. Best of all, CIMCO Edit is completely configurable and is easily adapted to any existing CNC program editing environment.

Every aspect of the latest CIMCO Edit is new, from the multi-pane tabbed layout to the dynamic toolbars and menus. CIMCO Edit includes new and powerful GUI, improved file compare utility, graphical backplotter, NC-Assistant, and more.

NC-Assistant

The NC-Assistant makes editing NC code faster and easier than ever. Point at any M or G code and the NC-Assistant will identify the code allowing you to modify values using an interactive interface linked to the CNC code. Input the desired values for any register and the NC-Assistant updates the CNC code automatically.

The NC-Assistant tool allows you to quickly insert and edit complex cycles and operations. CIMCO Edit includes built-in cycles and macros for the most common operations such as program start, program stop, and tool change. You can also record or create custom cycles and macros for the operations most common to your own specific setups and applications.

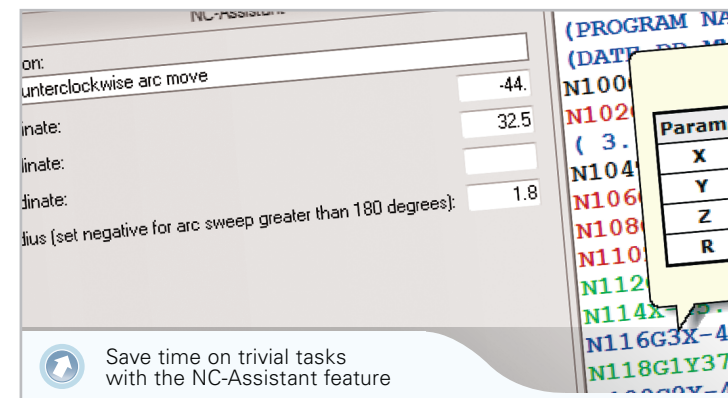

Graphical Backplotter

The 3D Mill / 2D Lathe backplotter handles your 3-axis mill and 2-axis lathe CNC programs with step and continuous forward and reverse plotting. Edit the CNC program and the update is automatically reflected in the plot. Analyze the plot with dynamic zoom, pan, rotate, and measuring functions. CIMCO Edit supports 3D graphical backplotting, stock, and final part verification in solids.

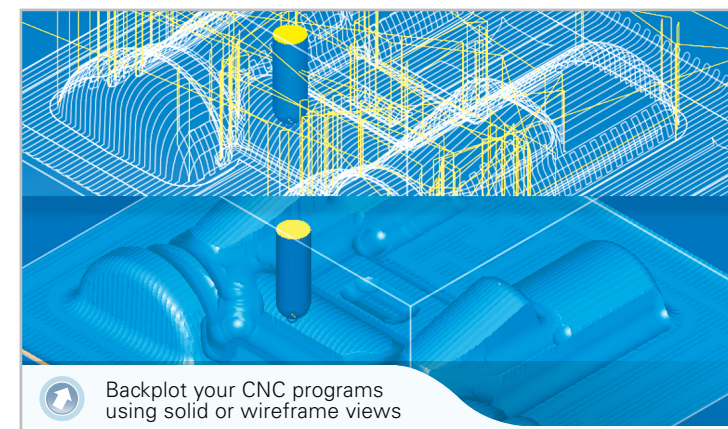

Intelligent File Compare

CIMCO Edit features a fast and fully configurable side-by-side file compare, allowing the user to quickly identify CNC program changes. The file compare identifies changed and deleted / inserted lines, but ignores trivial format changes like block re-numbering and spacing. Differences are displayed one line at a time, all at once, or printed side-by-side for offline review.

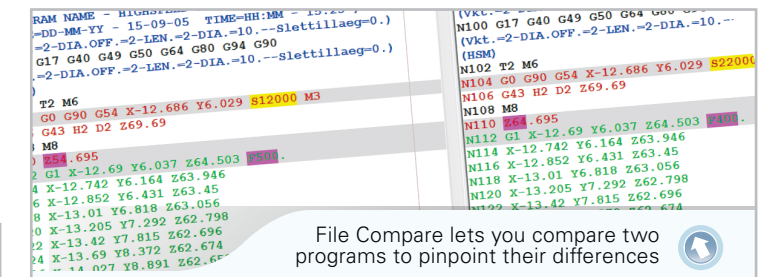

CNC Communications and DNC

CIMCO Edit includes DNC capabilities for reliable RS-232 communications with a variety of CNC controls. With the DNC option you can send and receive CNC programs to multiple machines simultaneously from inside CIMCO Edit.

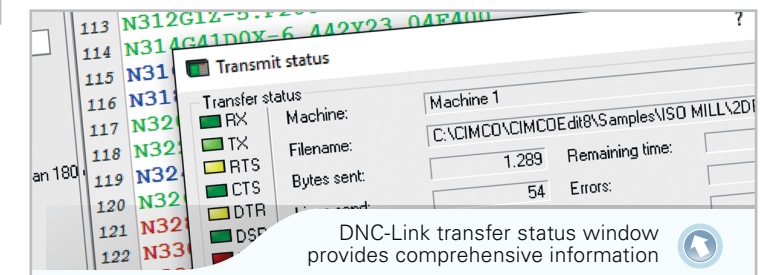

Support for Mazatrol files

CIMCO Edit comes with support for viewing Mazatrol Program files directly in the editor instead of on the Mazak Control in the workshop. Quickly verify and review program changes with Mazatrol file-compare.

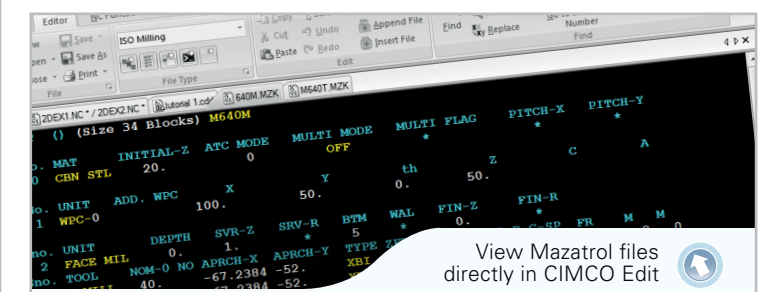

CIMCO CNC-Calc

A basic CAD/CAM for the shop floor

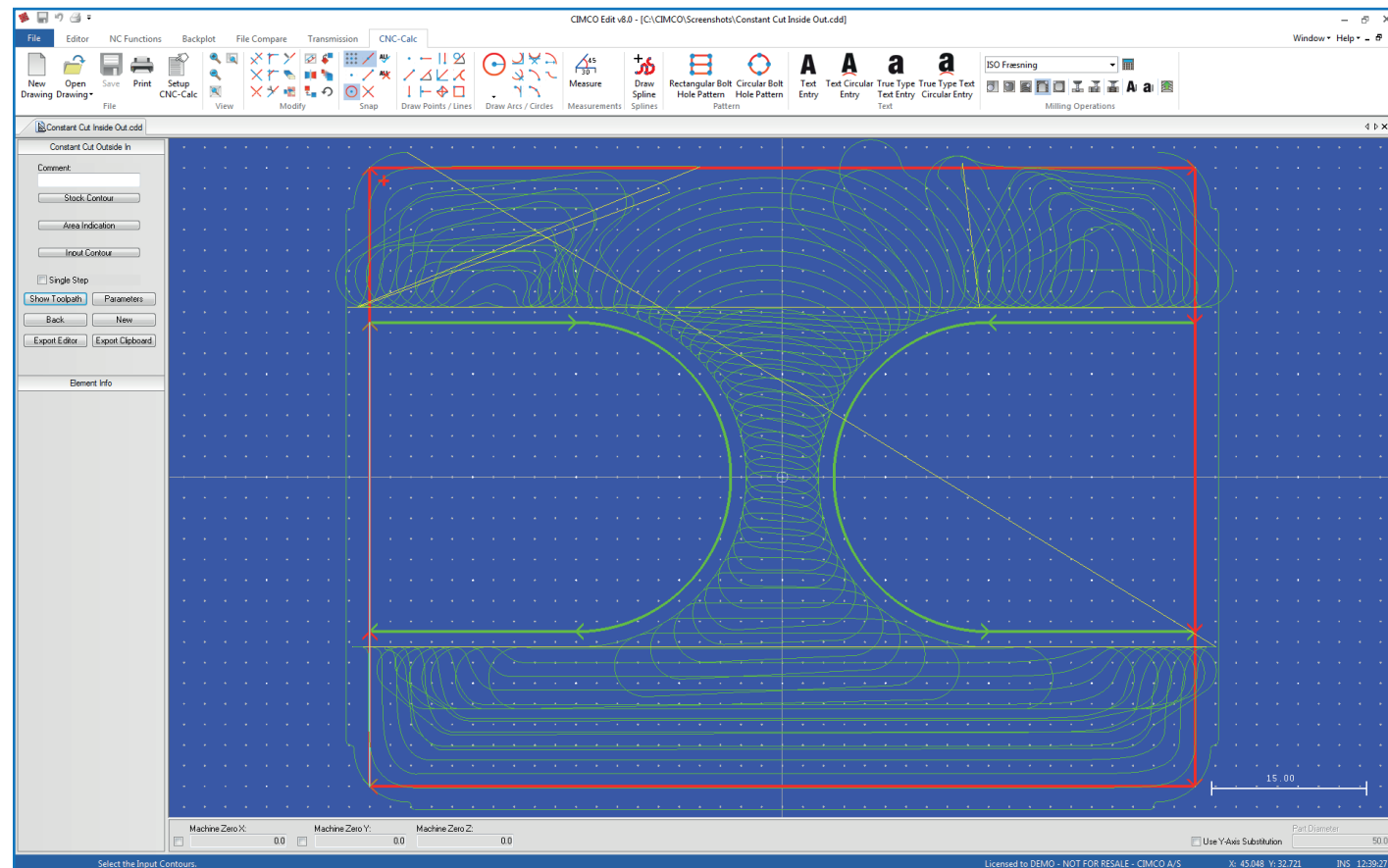

Designed for usability and productivity

CIMCO CNC-Calc is an add-on for CIMCO Edit that enables programmers on the shop floor to draw 2D geometrical contours, lay out toolpaths for mill and lathe, and simulate the resulting NC-program. CNC-Calc is a great tool for the operators and toolmakers on the shop floor who are not trained in working with an advanced CAD/CAM system. For them, CNC-Calc can help increase productivity and assist in the day-to-day NC-programming. For a small company it can be the first step into the CAD/CAM world.

CIMCO CNC-Calc is designed for ease-of-use and enables you to draw contours fast and easily. It features common functions for drawing lines and circles in relation to the coordinate system and/or existing geometry. Functionality ranges from the plain "horizontal line"

to the complex "circle tangent to three elements". It includes advanced trimming capabilities and an easy point and click approach to laying out CNC toolpaths.

CIMCO CNC-Calc also imports DXF files. From DXF it is possible to generate toolpaths for lathes and mills, such as ISO and Heidenhain conversational programming. Other features include generation of user-defined compensation types like computer, controller, wear, and reverse wear.

With CIMCO CNC-Calc being an integrated part of CIMCO Edit it is an easy task to view, edit, and simulate generated toolpaths. This enables you to validate your program and thereby optimize the use of machine resources.

2D Drawing Capabilities

CIMCO CNC-Calc is easy to learn and a great tool for drawing simple 2D contours. However, the comprehensive set of available functions in CNC-Calc also makes it suitable for handling more complex geometrical drawings. Drawing functions in CNC-Calc include advanced trimming of elements, easy creation of fillets, full support for transformations, many options for snapping to elements, and easy creation of both rectangular and circular bolt hole patterns.

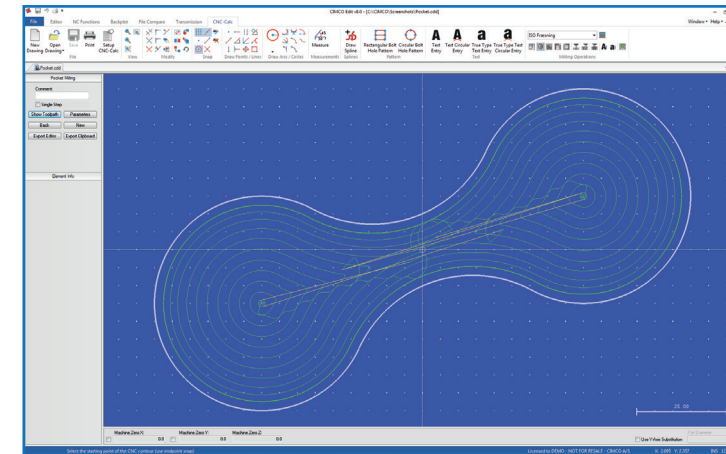

Backplot and cycles/macros

Since CNC-Calc is an add-on for CIMCO Edit, all functionality of the editor can be seamlessly used. This includes the built-in 3D Mill / 2D Lathe backplotter which handles your 3-axis mill and 2-axis lathe CNC programs with step and continuous forward and reverse plotting. Further, the built-in cycles and macros for common operations like program start, program stop, and tool change are provided. You can also record or create custom cycles and macros for the operations most common to your own specific setups and applications.

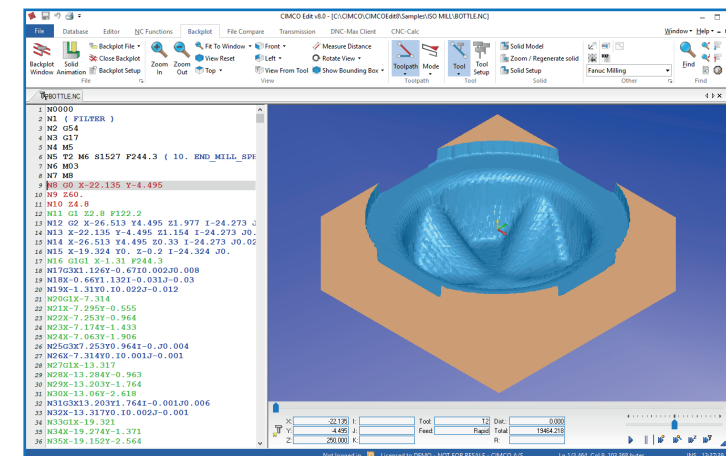

Strategies for 2D Milling and Turning

Once your 2D geometry is drawn CIMCO CNC-Calc makes it easy to lay out milling and turning toolpaths as well as drilling operations. By applying suitable toolpath strategies to your model CNC-Calc can generate the NC-code for you. Some of the strategies supported are:

Milling

- Facing
- Contouring
- Pocket
- Drilling
- Thread Milling
- Letter Milling

Turning

- Roughing
- Facing
- Finishing
- Grooving
- Thread (ID, OD)
- Cutoff

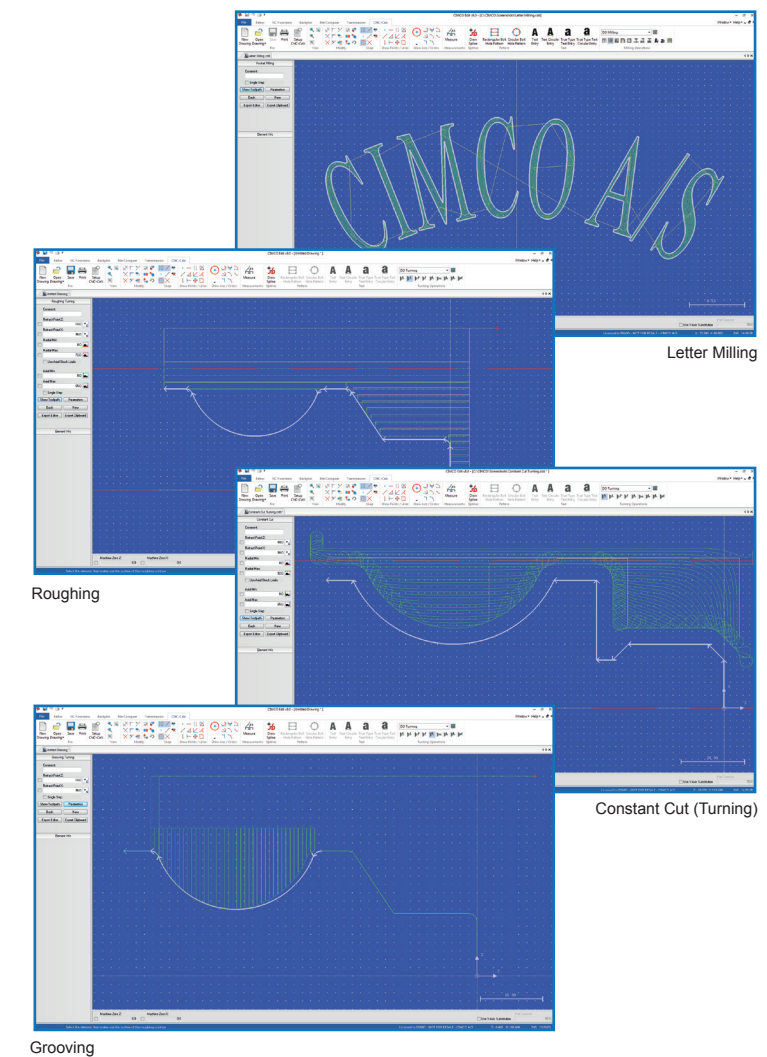

CIMCO NC-Base

Professional CNC program management

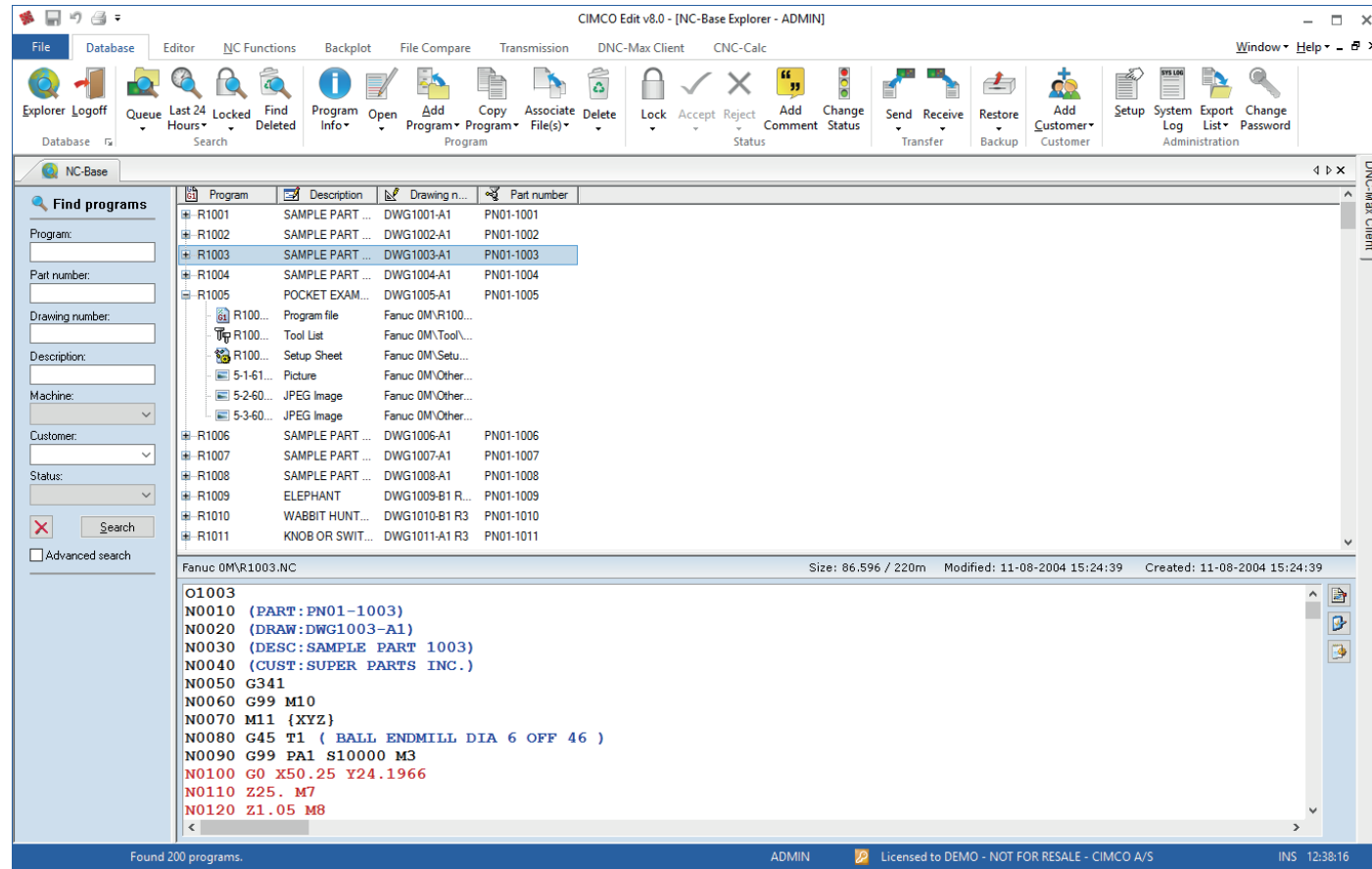

Information Management

Management of part programs and associated production documents is often a time-consuming task for CNC programmers and operators. CIMCO NC-Base takes care of that job and goes one step further. By providing a management and search and editing environment that are integrated and highly flexible, programmers and operators are guaranteed to work more effectively.

Achieving product and quality goals today requires that the correct information and data get to the right individuals and equipment as efficiently as possible. CIMCO NC-Base is the CNC program management tool that allows you to organize and manage your CNC programs and related production documents most effectively through the use of a reliable and fast SQL relational database.

CIMCO NC-Base is production centric, designed to be used by people in the programming department and on the shop floor. With NC-Base, CNC programmers and production staff can assemble virtual folders containing all the necessary data used by machinists, operators, quality staff, and others who are responsible for finished parts.

Why just send CNC programs to the shop floor when you can also provide setup sheets, tool lists, images, and other vital information required to manufacture parts? This information may be accessed from PCs running the NC-Base Client, or printed out for manual distribution. CNC operators can access and update information in NC-Base directly from the CNC control, or any PC on the shop floor. Either way, NC-Base helps ensure the right part gets made right every time.

Storage and Retrieval

Effective storage requires an organized framework for managing and accessing vital production information. Using industry standard relational SQL databases like Microsoft SQL and MySQL, CIMCO NC-Base provides a fast, flexible, and reliable system for all your production information.



Documentation

Associate all types of production data with your CNC programs to minimize mistakes and scrap. You may associate files created outside CIMCO Edit, such as tool lists, setup sheets, inspection notes, etc., or have them created automatically from data contained in your CNC program. You may also launch external applications for the viewing or editing of all file types.

Version Control

CIMCO NC-Base features a comprehensive, yet easy to use, version control system that automatically tracks any changes made, not only to the CNC programs, but also to associated production documentation. Every version of a file is stored in the system, along with information about when the change was made, who made it, and why it was made. The operator can at any time create a new version or restore an older version. Using the integrated compare function, different versions can be quickly compared side by side.

ADMIN	13:54:30	3	Program
ADMIN	13:54:32	3	Program F
ADMIN	13:53:37	3	Program f
ADMIN	13:53:04	3	Backup c
ADMIN	13:53:04	2	Program
ADMIN	13:51:24	2	Program
ADMIN	13:51:16	2	Program
		1	New or

Automatically track changes made to programs and associated documentation

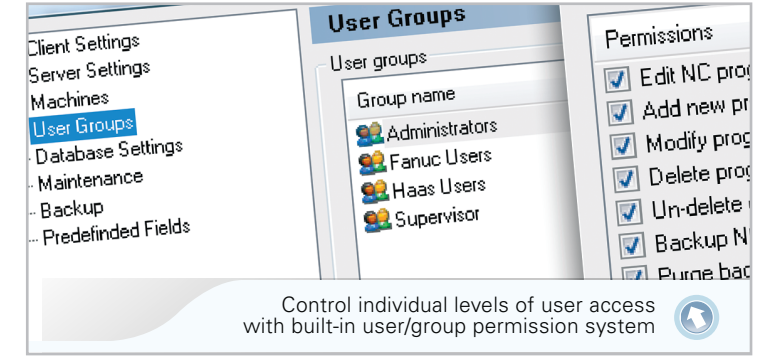

User Management

Controlling who can access and modify information is a critical component in any information management system. CIMCO NC-Base achieves this by using a highly flexible user/group permission system that allows the administrator to specify who is allowed to view, modify, approve files, etc.

System Integration

CIMCO NC-Base is fully integrated with CIMCO DNC-Max, our flagship CNC networking solution, allowing operators to request and retrieve CNC programs or save "as-run" CNC programs directly from the CNC control or NC-Base client.

CIMCO NC-Base integrates seamlessly with most CAD/CAM applications. Using the auto import function, programs generated in the programming department are automatically imported into the database. Existing ERP/PDM systems can extract data directly from the SQL database. Program information can also be exported to text files, MS Excel spreadsheets, etc.

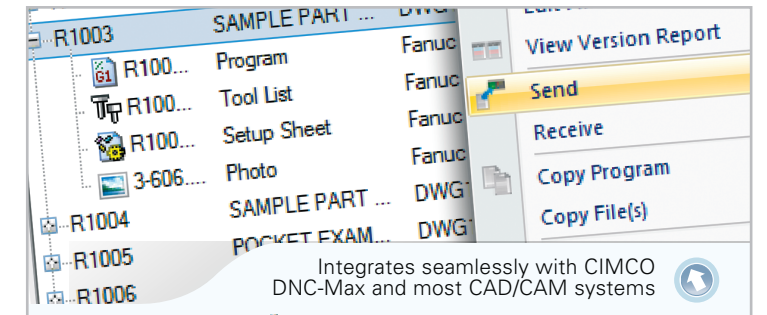

Automated backup

Using the NC-Base backup server, a complete backup of all the information in the database, including part programs, associated production documentation, etc., is automatically performed every day. In case of a backup failure, system administrators are automatically notified by e-mail.

CIMCO DNC-Max

Professional CNC communication

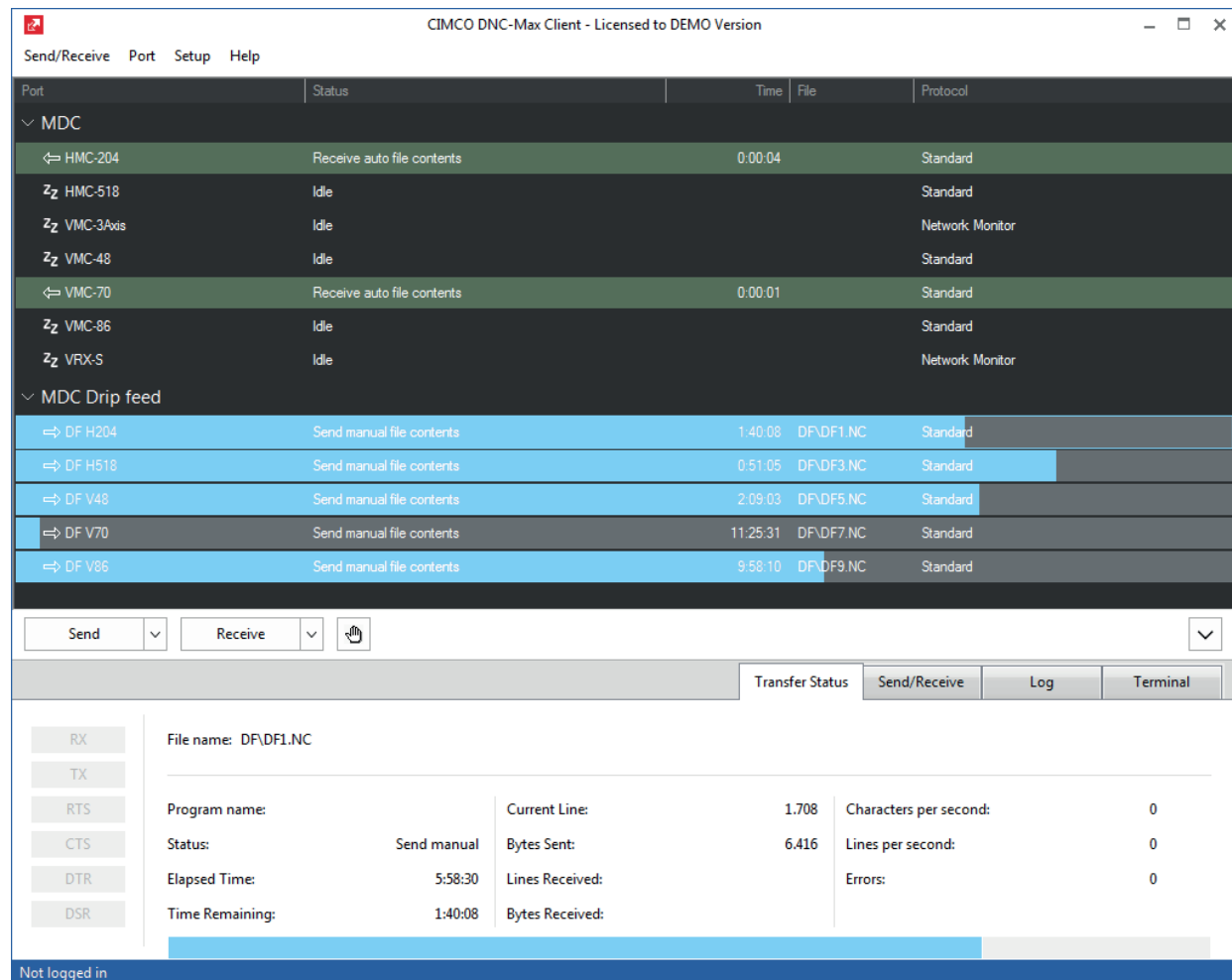

Reliable CNC Communication

CIMCO DNC-Max is the latest version of the most trusted CNC communication software on the market and provides end-to-end functionality designed to make every aspect of CNC communications more reliable and efficient. From its highly adaptable remote request and auto-receive to its advanced client/server architecture, DNC-Max continues to be the software solution of choice.

DNC-Max is designed to be the complete DNC solution for all your CNC equipment. In addition to standard Fanuc/Haas style controls DNC-Max includes the most comprehensive support for Heidenhain, Mazak, Fagor, etc.

DNC-Max works with off-the-shelf, industry standard RS-232 serial communications hardware, including Ethernet and Wireless serial device servers, traditional card based hardware, and existing legacy hardware.

Whether you set up your first system or you replace an existing system, the DNC application you choose must be compatible with your data. DNC-Max eliminates the need to update all your existing NC programs.

File transfers, port monitoring and system administration are performed in a clean, intuitive client/server interface. This is part of the system's intelligent, solution-driven design.

The Right Tool for the Job

CIMCO DNC-Max is the only choice for customers who demand performance, flexibility, and reliability. Whether your solution is for a small shop with a few CNCs or a corporate solution for hundreds of machines in multiple remote facilities, DNC-Max is the proven solution.

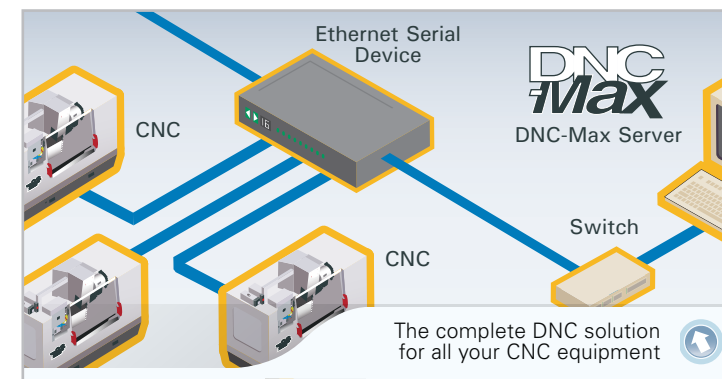

The DNC-Max Server

The DNC-Max server is the DNC engine responsible for all communications-related activities. Users can choose to run the DNC-Max Server as a service or as an application. This is the core component of DNC-Max.

The DNC-Max Client

The DNC-Max client is the application used for local or remote file transferring, port monitoring, and port management. The DNC-Max Client can access one or more DNC-Max Servers across a LAN, WAN, or even the Internet.

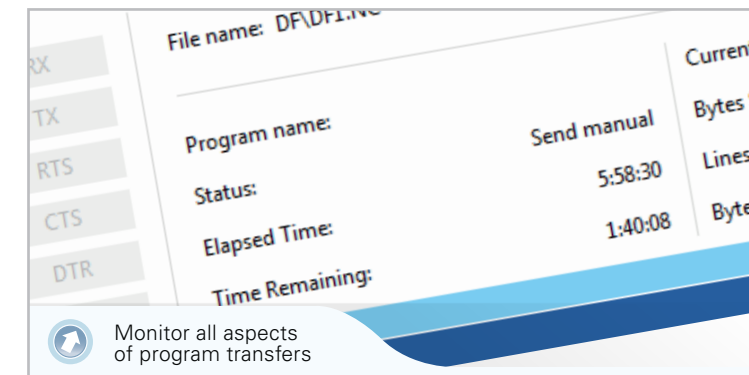
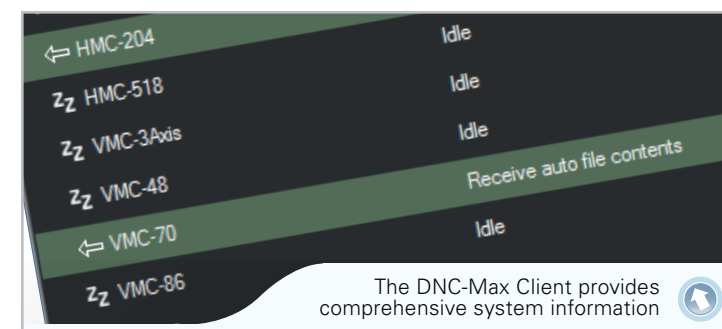

New or Improved Features in CIMCO DNC-Max

Global

- Improved Windows User Interface
- Expanded Administration Capabilities
- Enhanced Remote Server Config
- License Server Support
- Remote CIMCO Support Client

The DNC-Max Server

- System Backup/Restore
- Serial Device Server Speed Booster
- Global Port Settings Export Utility
- Enhanced NC-Base Integration
- Enhanced Data Collection Support

Protocols

- More Remote Request Options
- Directory Listing Wildcard Support
- More Directory List Formats/Filters
- Device Server Port Monitoring

The DNC-Max Client

- Improved UI Customization
- User Proximity UI Modes
- Port Group Configuration
- DAQ Device Setup and Configuration
- Improved Remote Server Access
- Updated Pocket PC Client

More than 100 other additions and enhancements.

Extending the Power of DNC-Max

CIMCO DNC-Max integrates with CIMCO NC-Base for a complete CNC program management solution, and CIMCO MDC-Max for machine data collection and shop floor monitoring.

CIMCO DNC-Max Wireless

A turnkey wireless DNC system

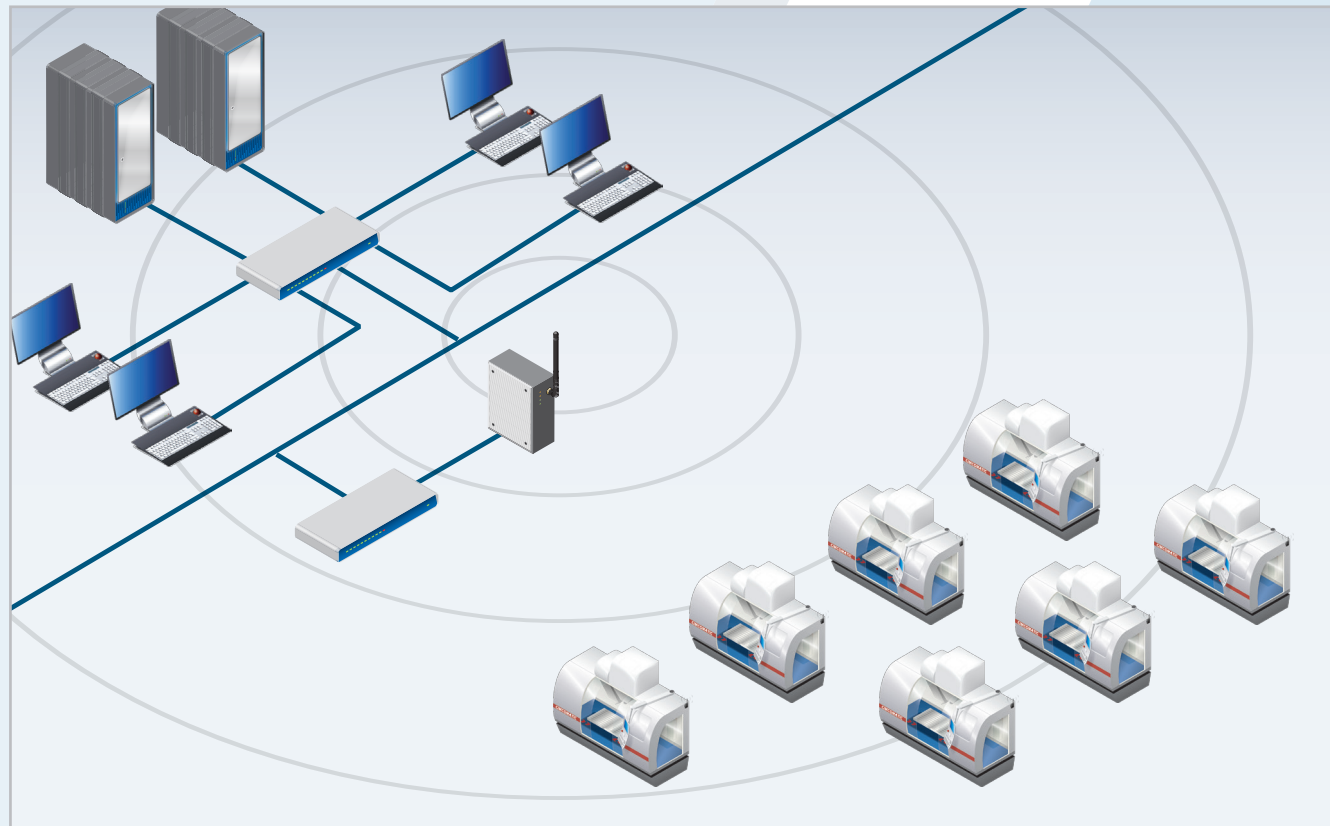

Competence in DNC Systems

To make the right choice it is important to choose not only the best available DNC solution but also a manufacturer with many years of experience to ensure reliable implementation and after-sales support.

Since 1991 CIMCO Integration has sold more than 100,000 DNC Systems through experienced DNC partners and consultants all over the world.

To meet the demands of customers who wish to replace their legacy wired and trouble-prone system - perhaps still set up with data switches - or to implement new solutions in workshops where CNCs are frequently relocated, CIMCO Integration offers DNC-Max Wireless as a turnkey wireless DNC system letting our well-known DNC-Max software connect to your CNC machines through a Wireless network.

DNC-Max Wireless means:

1. No data cabling is necessary, except for the short distance from the wireless DNC Device Server to the physical RS-232 CNC port - here, traditional cable and connectors are used.
2. CNC machine tools may be relocated frequently, but they need not be rewired and usually not even reconfigured: identification (e.g. machine no.) and transmission parameters remain unchanged in the current DNC software set-up (.mch-files).

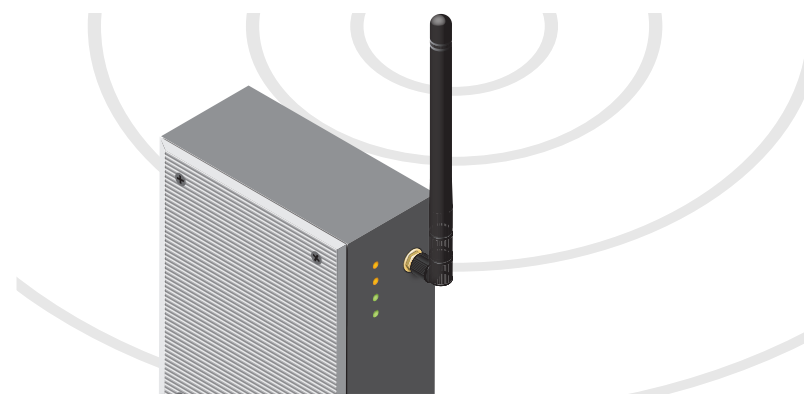

How The System Works

A patch cable between the Wireless DNC Access Point and an Ethernet switch connects your cabled and your wireless networks. At the other end, a Wireless DNC Device Server mounted on the CNC converts the received radio signals to RS-232. Line-of-sight distances of up to 100m are safely bridged, and the high data transfer rate of 22 Mbps guarantees serial data transmission with the highest baud rate for COM ports - 115,200 Bd.

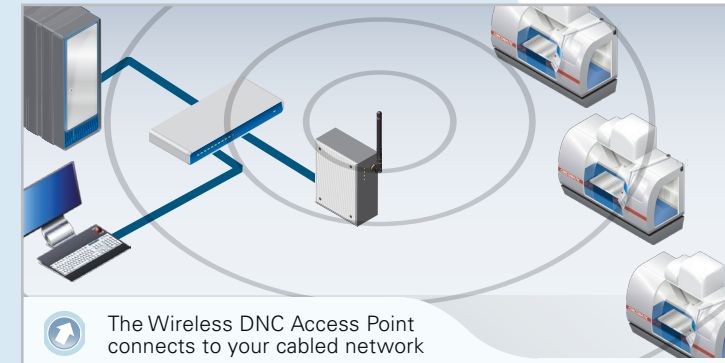

Even in workshops with strong electromagnetic interference wireless data transmission provides a high operational reliability thanks to the multiple checksum verification performed by the Ethernet TCP protocol. Data packets are simply re-transmitted until checksums match. To prevent unauthorized access to the NC data transmission WPA, Wi-Fi Protected Access, is integrated providing encryption with key lengths of up to 256 bits.

Wireless DNC Access Points

Wireless DNC Access Points are Ethernet hubs that convert the DNC Ethernet communications to wireless IEEE 802.11b(+) signals and vice versa, and are mounted to the network like any other wired Ethernet device (PC, hub, switch, router, etc.).

Wireless DNC Access Points transmit the NC data via a directional or an omni-directional antenna from/to a wired network to/from the Wireless DNC Device Server mounted on or near the CNC machine tools in the workshop.

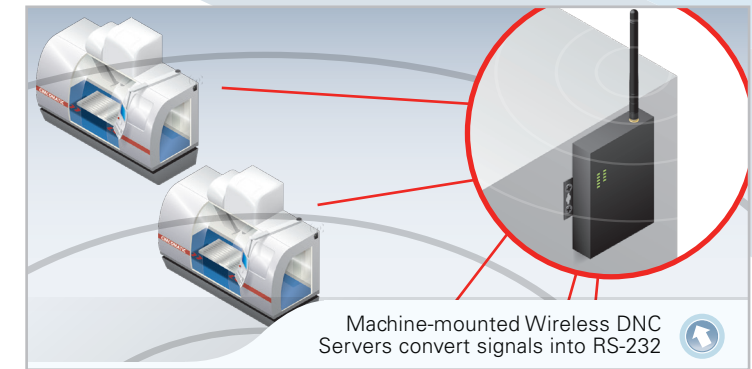

Wireless DNC Server

Wireless DNC Device Servers each connect to 1, 2, or 4 CNCs and receive/send the NC data from/to the nearest Wireless DNC Access Point via attached antennae. Received radio signals are converted into the RS-232 format, which is understood by the connected CNCs.

On the hardware side the adaptor output port will be connected to the CNC interface (DB-25/f, DB-9/m, DB-25/m) by a short, shielded data cable or, also possible, using fibre optics ensuring perfect galvanic insulation and insensibility to electrical noise. NC data sent from a CNC to be stored on the DNC server pass through the same connection.

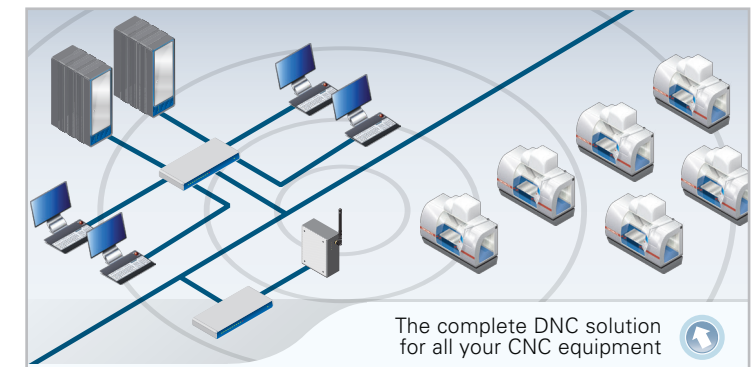

The complete DNC solution for all your CNC equipment

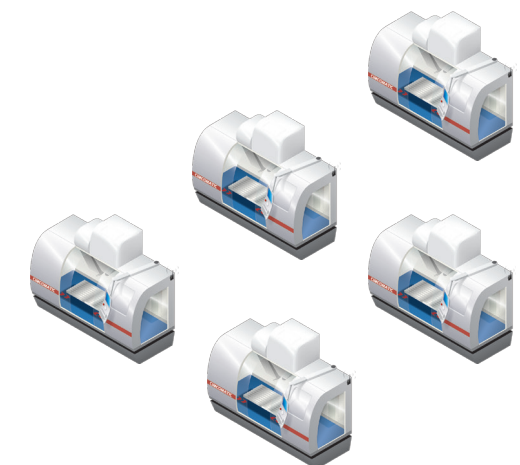

DNC-Max Network Solutions

Adding DNC-Max to your setup

Ethernet Serial Port Server



DNC-Max Network Solution with Ethernet Serial Port Server

Ethernet Serial Port Server

Ethernet offers a significant improvement in reliability and maximum cable lengths over conventional RS-232 cabling. Not all existing equipment, however, offers Ethernet or TCP/IP connectivity, but with Serial Port Servers even older CNC machines become part of the network.

Reduce Shop Floor Cabling

The Ethernet Serial Port Server is similar in function to an RS-232 multiport card. Whereas a multiport card must be installed in your PC the Serial Port Server simply connects to the Ethernet network. This allows the use of existing Ethernet infrastructure and significantly reduces the amount of cabling on the shop floor.

Single Server Operation

Place the Serial Port Server in the shop close to machine controls – or other equipment limited to RS-232 distances – and connect your server anywhere else on your network. Several hubs can be placed around your shop and all can be serviced by a single central DNC-Max server or by separate servers.

CIMCO DNC-Max supports

- Direct driver for Moxa and Quatech built in
- Auto-detecting 10/100 Mbps Ethernet interface
- Optional 3-in-1 interface supports RS-232/422/485
- Complete Ethernet and TCP/IP protocol
- Automatic network connection recovery

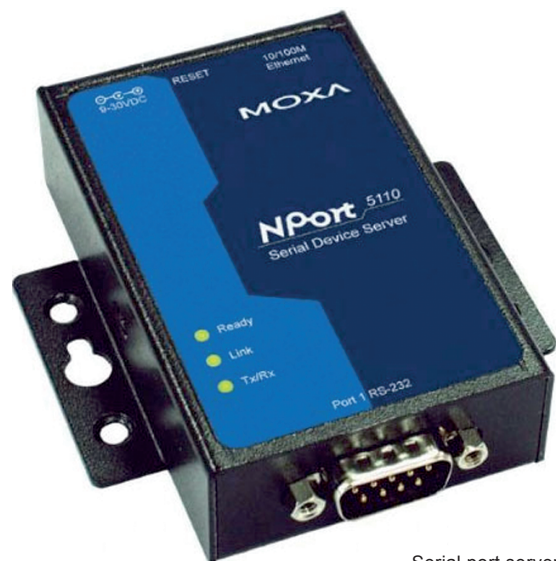

Serial port servers from Digi, Moxa, Control, etc.

Single Server Solutions

Connections for transmission with DNC-Max can be established in several ways. Depending on the extent and the environment of the installation, as well as the flexibility desired, you may opt for traditional RS-232 cabling directly between PC and CNC, noise

proof fibre optic cables with optic to RS-232 interface, or combinations with ethernet and wireless solutions using port servers and access points.

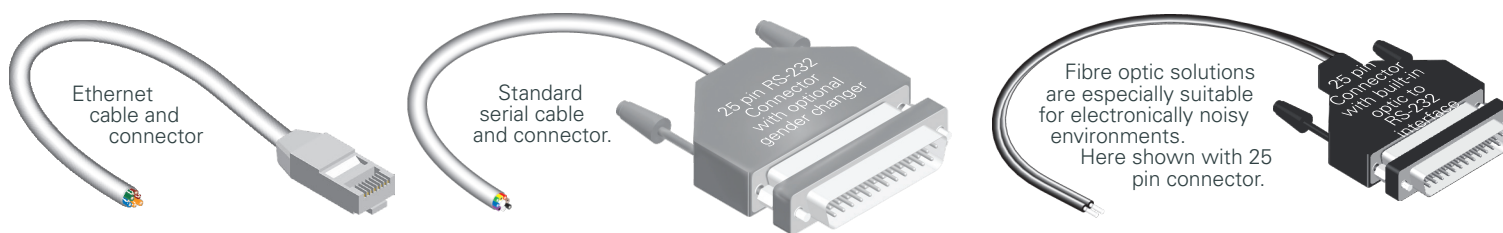
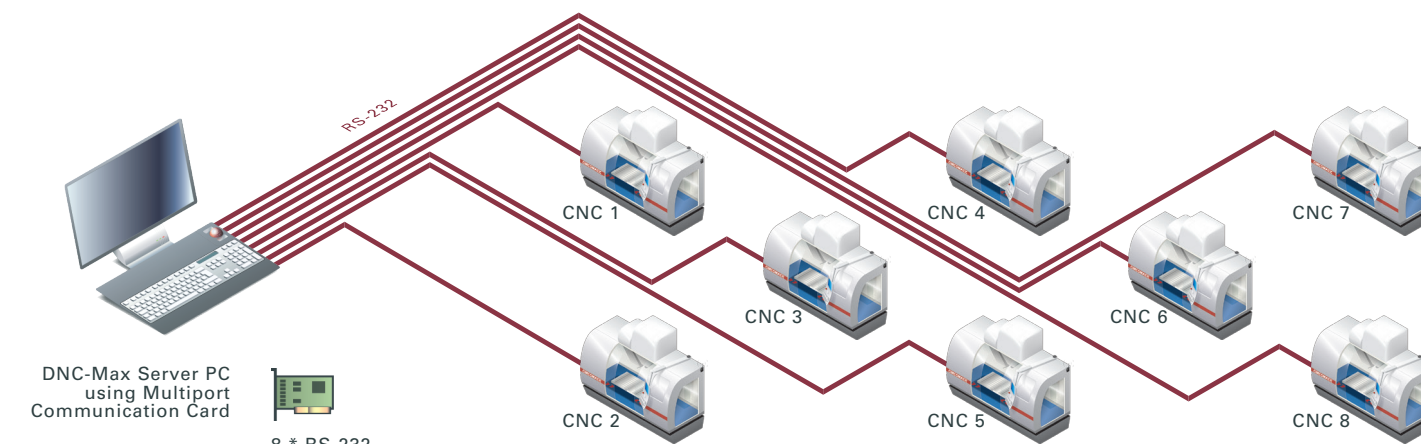
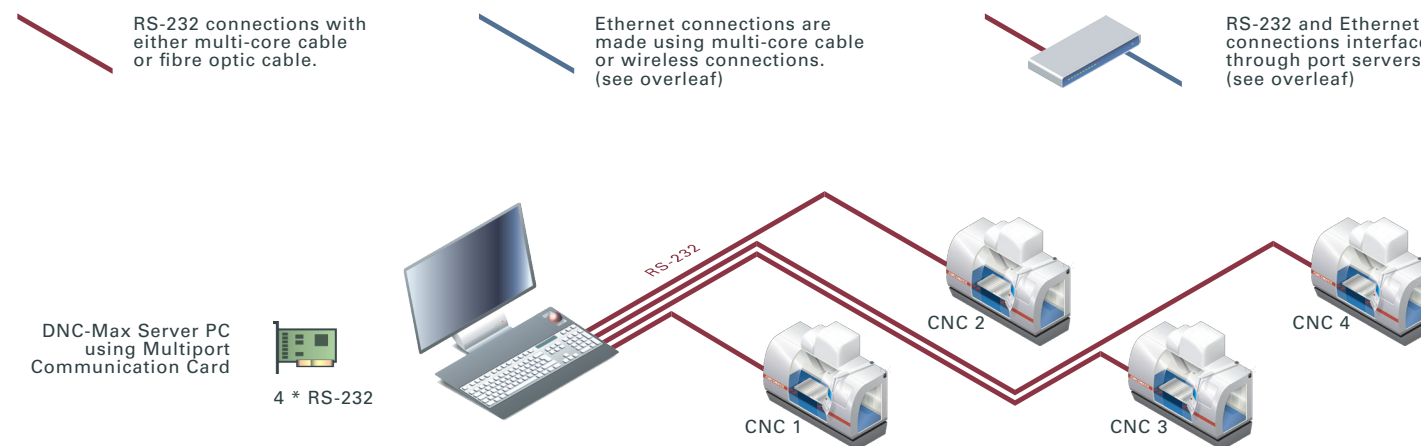

CIMCO MDC-Max

Manufacturing Data Collection

Make informed decisions

CIMCO MDC-Max is a real-time software machine tool data collection system that gives you instant reports and charts about your shop floor productivity. MDC-Max makes your decisions easy as they will be based on accurate data collected from your machine tools.

In today's complex and competitive global markets, it is more important than ever to maximize effective use of manufacturing equipment. CIMCO MDC-Max provides powerful machine data collection and analysis capabilities to make this task easier and gives you real-time reports including Overall Equipment Effectiveness (OEE).

All of this can be achieved without having to place a PC next to each machine tool - all the data can be collected by cable, wireless, or ethernet (network) to be stored centrally, even if you have multiple workshops to monitor.

CIMCO MDC-Max integrates with the latest version of the most trusted CNC-Communication software on the market - CIMCO DNC-Max.

A truly integrated solution

CIMCO MDC-Max is fully integrated with CIMCO DNC-Max and CIMCO NC-Base giving you a complete DNC, document gathering, and Machine Data Collection system from one supplier.

CIMCO MDC-Max

MDC-Max is the software responsible for collecting all the machine tool data for in-cycle and number of parts produced.

CIMCO DNC-Max

DNC-Max controls the sending and receiving of CNC programs to your range of machine tools. Programs can be requested from the machine control, thus avoiding the operator having to leave his machine. Any program changed by the operator and sent back to DNC-Max can be automatically raised in version or stored in a quarantine area. This gives you the ability to track changes and revert to any previous version if necessary.

CIMCO NC-Base

The data collected by MDC-Max can be analysed immediately by the NC-Base module to produce graphs and charts showing you exactly what is happening with your production schedules.

NC-Base also allows you to store any documents related to a particular job. These can be drawings, photographs of machine setups, tool lists, operation sheets, CNC programs, etc. This makes finding any information about a particular job extremely easy.



Realtime Machine Display

Reports and Graphs

With the build-in report functions you can easily display your data to enable you to explore down to the appropriate level to see exactly what is happening with your production schedules.

- Cycle Time per Part (min, max and average)
- Number of parts per shift / operator
- Number of scrapped parts
- Machine downtime
- Scheduled maintenance
- Unscheduled maintenance
- Setup Time per part
- Operator effectiveness
- Overall Equipment Effectiveness (OEE)
- Realtime Machine Display (see which machines are running at a glance)

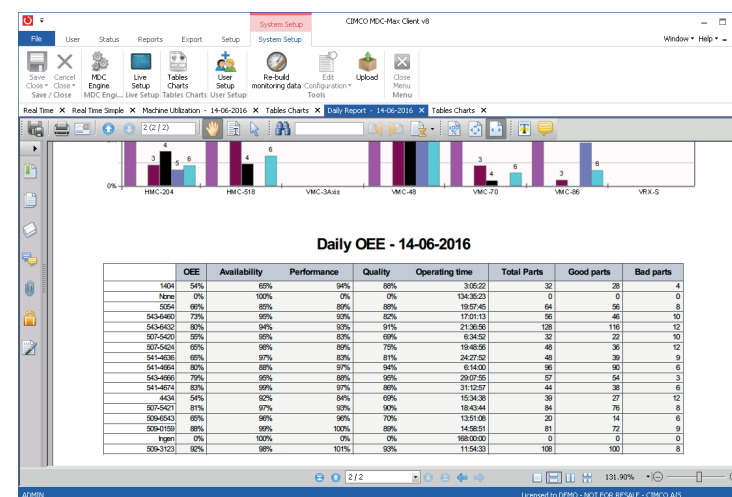
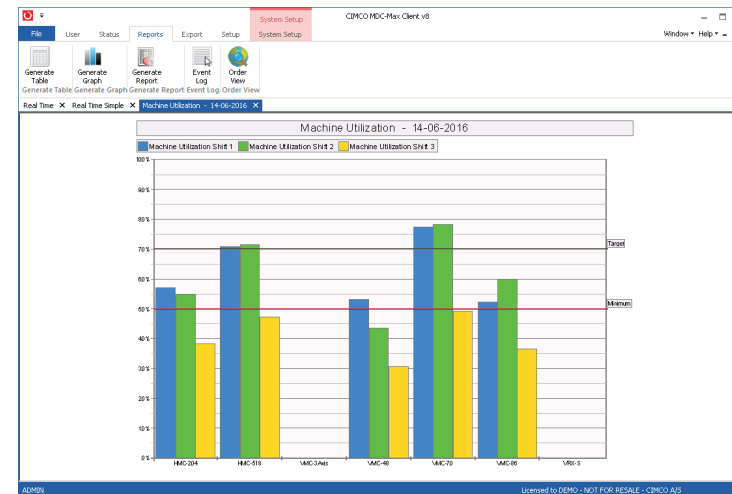
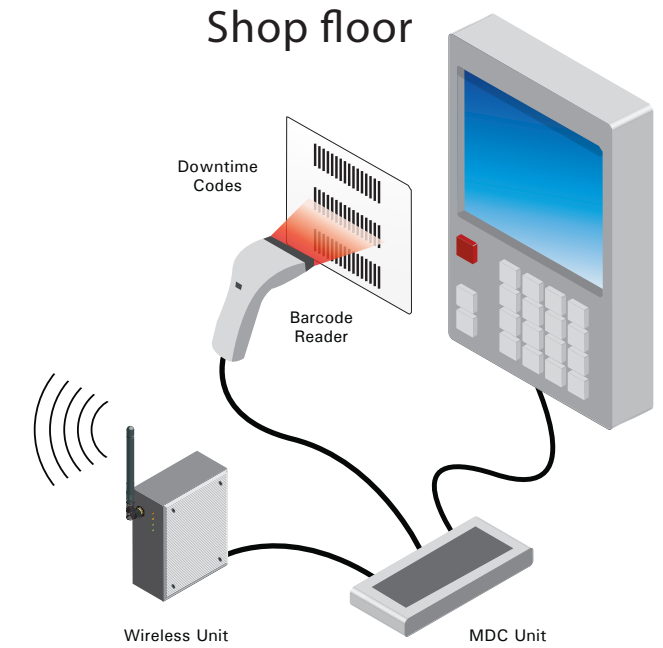
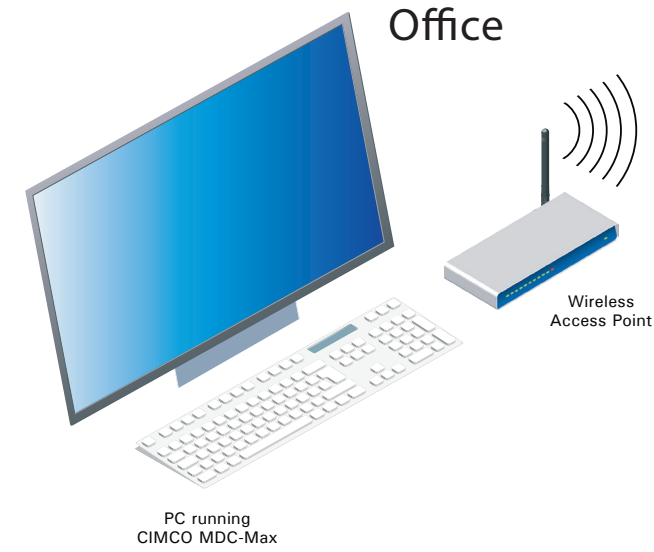

How MDC-Max works

On a typical installation we fit one of our MDC units into the machine control. This unit is wired into the Cycle Start and Parts Counter relays. Every time the machining cycle or the parts counter signal is detected by the MDC unit, a code is sent back to the MDC-Max software. Because of the variety of types of machine controls the monitored signals may vary depending on customers' requirements.

These codes are recorded in realtime on the computer system and can be displayed immediately in a graphical format.

If a machine is not in production for any reason the operator can scan a barcode to let the MDC-Max system know why the machine has stopped. These codes can be customised to suit your company, but typical barcodes would be for the following reasons:

- Waiting for Setter
- Waiting for Maintenance
- Waiting for Tooling
- Waiting for Material
- Waiting for ...

As MDC-Max records all this information you can then produce reports to see how much production time has been lost due to waiting for tooling, etc.

For more information visit
www.cimco.com

CIMCO Integration was founded in 1991, and from the beginning we have been focused on providing software solutions and integration work in the area of Computer Integrated Manufacturing. Today, we develop and market a wide range of products, including CNC-Editors,

DNC-Servers, software for rapid NC-program simulation, and database applications for managing NC-programs. CIMCO Integration has sold more than 100,000 software licenses through experienced CAD/CAM/CNC resellers and consultants all over the world.



Reseller

Europe

CIMCO A/S
Copenhagen
Denmark

Tel: +45 45 85 60 50
Fax: +45 45 85 60 53

E-mail: info@cimco.com
Web: www.cimco.com

CIMCO Americas

CIMCO Americas, LLC
651 S Sutton Road, Suite 276
Streamwood, IL 60107

Tel: +1 704 644 3587
Fax: +1 704 943 0514

E-mail: infous@cimco.com
Web: www.cimco.com

