

Unit in mm

High Power Switching Applications

Motor Control Applications

- Integrates Inverter, Converter and Brake Power Circuits in One Package.
- Output (Inverter Stage)
 - : 3ø20A/600V High Speed Type IGBT
 - $V_{CE(sat)} = 4.00V$ (Max.)
 - $t_f = 0.30\mu s$ (Max.)
 - $t_{rr} = 0.15\mu s$ (Max.)
- Input (Converter Stage)
 - : 1ø30A/800V Silicon Rectifier
 - $V_F = 1.20V$ (Max.)
- Brake Stage
 - : 15A/600V IGBT & 15A/600V FRD
- The Electrodes are Isolated from Case.

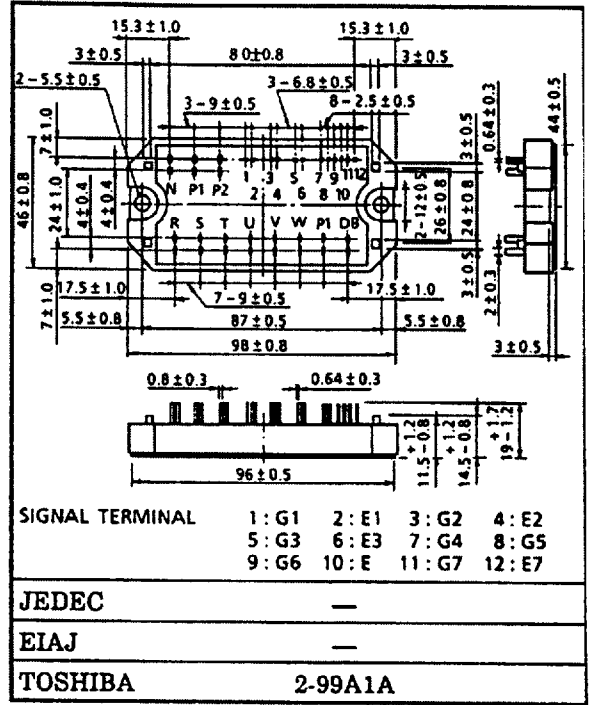

JEDEC	—
EIAJ	—
TOSHIBA	2-99A1A

Weight : 175g

Equivalent Circuit

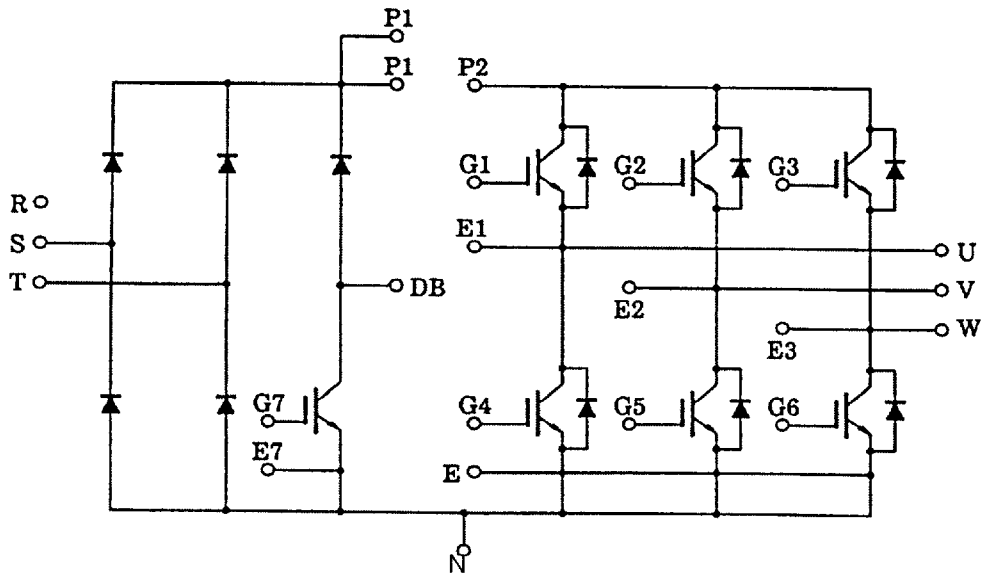

The information contained here is subject to change without notice. The information contained herein is presented only as guide for the applications of our products. No responsibility is assumed by TOSHIBA for any infringements of patents or other rights of the third parties which may result from its use. No license is granted by implication or otherwise under any patent or patent rights of TOSHIBA or others. These TOSHIBA products are intended for usage in general electronic equipments (office equipment, communication equipment, measuring equipment, domestic electrification, etc.) Please make sure that you consult with us before you use these TOSHIBA products in equipments which require high quality and/or reliability, and in equipments which could have major impact to the welfare of human life (atomic energy control, spaceship, traffic signal, combustion control, all types of safety devices, etc.). TOSHIBA cannot accept liability to any damage which may occur in case these TOSHIBA products were used in the mentioned equipments without prior consultation with TOSHIBA.

MIG20J951H

Maximum Ratings (Ta = 25°C)

STAGE		CHARACTERISTIC		SYMBOL	RATINGS	UNIT	
Inverter	Collector-Emitter Voltage			V_{CES}	600	V	
	Gate-Emitter Voltage			V_{GES}	±20	V	
	Collector Current	DC		I_C	20	A	
		1ms		I_{CP}	40		
	Forward Current	DC		I_F	20	A	
1ms			I_{FM}	40			
Collector Power Dissipation (Tc = 25°C)				P_C	80	W	
Converter	Repetitive Peak Reverse Voltage			V_{RRM}	800	V	
	Average Output Rectified Current			I_O	30	A	
	Peak One Cycle Surge Forward Current (50Hz, Non-Repetitive)			I_{FSM}	400	A	
Brake	IGBT	Collector-Emitter Voltage			V_{CES}	600	V
		Gate-Emitter Voltage			V_{GES}	±20	V
		Collector Current	DC		I_C	15	A
			1ms		I_{CP}	30	
	Collector Power Dissipation (Tc = 25°C)				P_C	65	W
	FRD	Repetitive Peak Reverse Voltage			V_{RRM}	600	V
		Forward Current	DC		I_F	15	A
1ms				I_{FM}	30		
Module	Junction Temperature			T_j	150	°C	
	Storage Temperature Range			T_{stg}	-40 ~ 125	°C	
	Isolation Voltage			V_{isol}	2500 (AC 1 minute)	V	
	Screw Torque			—	3	N•m	

Electrical Characteristics (Ta = 25°C)

a. Inverter Stage

CHARACTERISTIC		SYMBOL	TEST CONDITION	MIN.	TYP.	MX.	UNIT
Gate Leakage Current		I_{GES}	$V_{GE} = \pm 20V, V_{CE} = 0$	–	–	± 20	μA
Collector Cut-off Current		I_{CES}	$V_{CE} = 600V, V_{GE} = 0$	–	–	1.0	mA
Gate-Emitter Cut-off Voltage		$V_{GE (off)}$	$V_{CE} = 5V, I_C = 20mA$	3.0	–	6.0	V
Collector-Emitter Saturation Voltage		$V_{CE (sat)}$	$I_C = 20A, V_{GE} = 15V$	–	3.0	4.0	V
Input Capacitance		C_{ies}	$V_{CE} = 10V, V_{GE} = 0$ $f = 1MHz$	–	1300	–	pF
Switching Time	Turn-on Delay Time	$t_{d(on)}$	Inductive Load $V_{CC} = 300V$ $I_C = 20A$ $V_{GE} = \pm 15V$ $R_G = 120\Omega$ (Note 1)	–	0.08	0.16	μs
	Rise Time	t_r		–	0.12	0.24	
	Turn-on Time	t_{on}		–	0.40	0.80	
	Turn-off Delay Time	$t_{d(off)}$		–	0.30	0.60	
	Fall Time	t_f		–	0.15	0.30	
	Turn-off Time	t_{off}		–	0.60	1.00	
Forward Voltage		V_F	$I_F = 20A, V_{GE} = 0$	–	1.7	2.5	V
Reverse Recovery Time		t_{rr}	$I_F = 20A, V_{GE} = -10V$ $di/dt = 50A/\mu s$	–	0.08	0.15	μs
Thermal Resistance		$R_{th(j-c)}$	Transistor	–	–	1.56	$^{\circ}C/W$
			Diode	–	–	2.80	

b. Converter Stage

CHARACTERISTIC	SYMBOL	TEST CONDITION	MIN.	TYP.	MX.	UNIT
Repetitive Peak Reverse Current	I_{RRM}	$V_{RRM} = 800V$	–	–	50	μA
Peak Forward Voltage	V_{FM}	$I_{FM} = 30A$	–	1.05	1.20	V
Peak One Cycle Surge Forward Current	I_{FSM}	50Hz Sine-half-wave	400	–	–	A
Thermal Resistance	$R_{th(j-c)}$	–	–	–	1.56	$^{\circ}C/W$

MIG20J951H

c. Brake Stage

CHARACTERISTIC		SYMBOL	TEST CONDITION	MIN.	TYP.	MX.	UNIT
Gate Leakage Current		I_{GES}	$V_{GE} = \pm 20V, V_{CE} = 0$	-	-	± 20	μA
Collector Cut-off Current		I_{CES}	$V_{CE} = 600V, V_{GE} = 0$	-	-	1.0	mA
Repetitive Peak Reverse Current		I_{RRM}	$V_{RRM} = 600V$	-	-	1.0	mA
Gate-Emitter Cut-off Voltage		$V_{GE(off)}$	$V_{CE} = 5V, I_C = 15mA$	3.0	-	6.0	V
Collector-Emitter Saturation Voltage		$V_{CE(sat)}$	$I_C = 15A, V_{GE} = 15V$	-	3.0	4.0	V
Input Capacitance		C_{ies}	$V_{CE} = 10V, V_{GE} = 0$ $f = 1MHz$	-	1000	-	pF
Switching Time	Turn-on Delay Time	$t_{d(on)}$	Inductive Load $V_{CC} = 300V$ $I_C = 15A$ $V_{GE} = \pm 15V$ $R_G = 150\Omega$ (Note 1)	-	0.08	0.16	μs
	Rise Time	t_r		-	0.12	0.24	
	Turn-on Time	t_{on}		-	0.40	0.80	
	Turn-off Delay Time	$t_{d(off)}$		-	0.30	0.60	
	Fall Time	t_f		-	0.30	0.55	
	Turn-off Time	t_{off}		-	0.65	1.00	
Forward Voltage		V_F	$I_F = 15A, V_{GE} = 0$	-	1.7	2.5	V
Thermal Resistance		$R_{th(j-c)}$	Transistor	-	-	1.92	$^{\circ}C/W$
			Diode	-	-	2.80	

Note. 1 Switching Time Test Circuit & Timing Chart

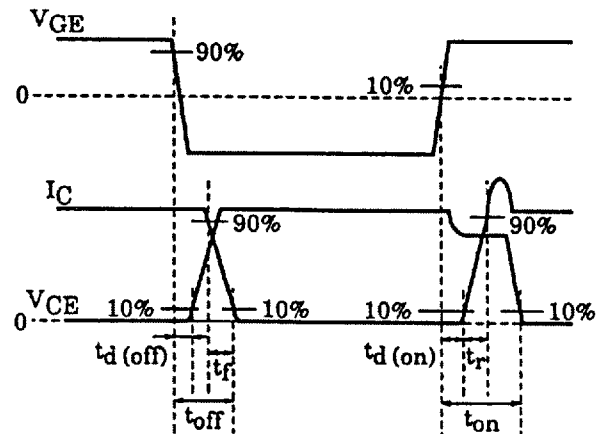
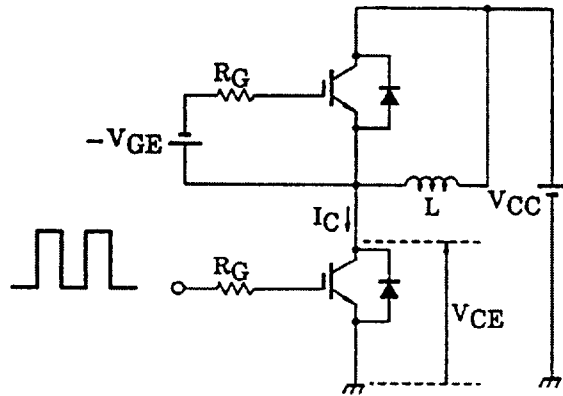

a. Inverter Stage

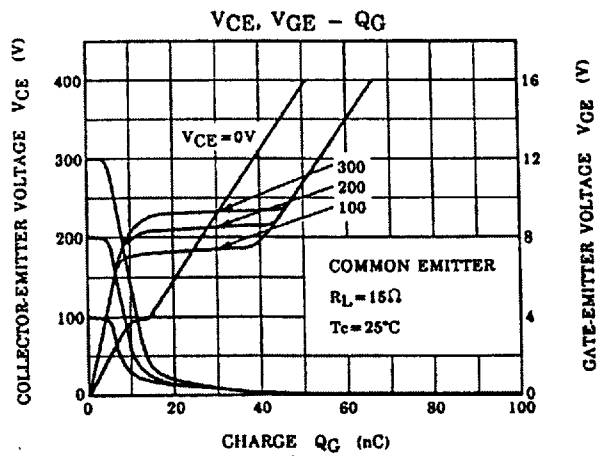
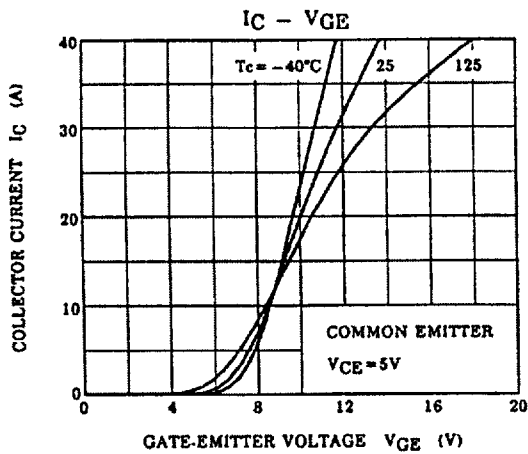
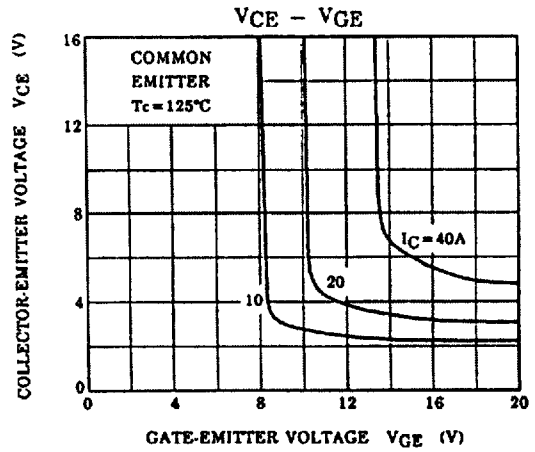
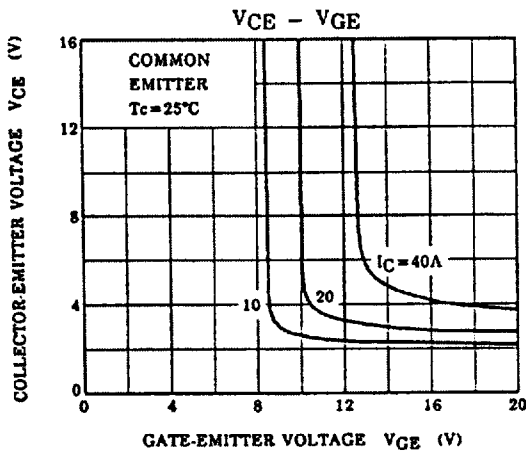
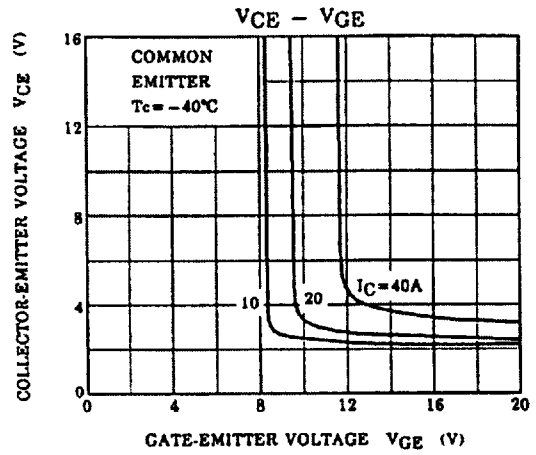
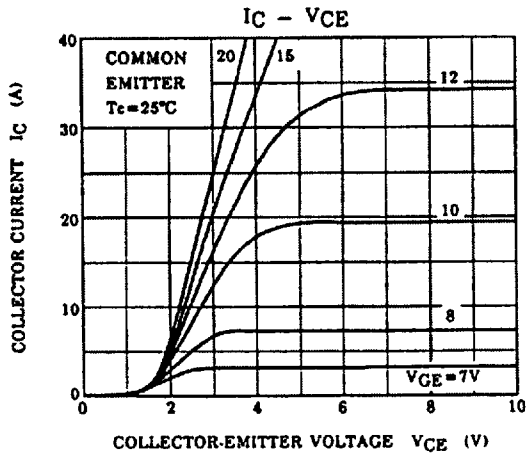

a. Inverter Stage

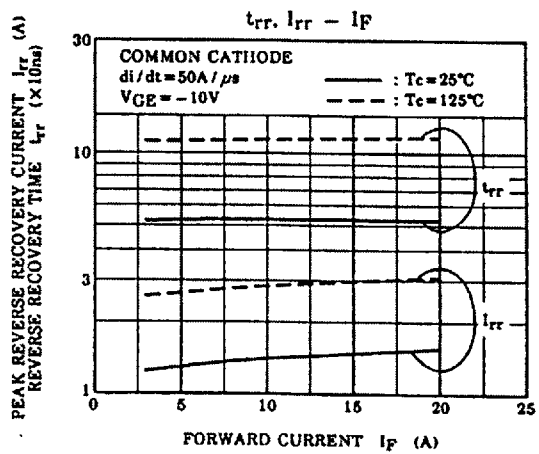
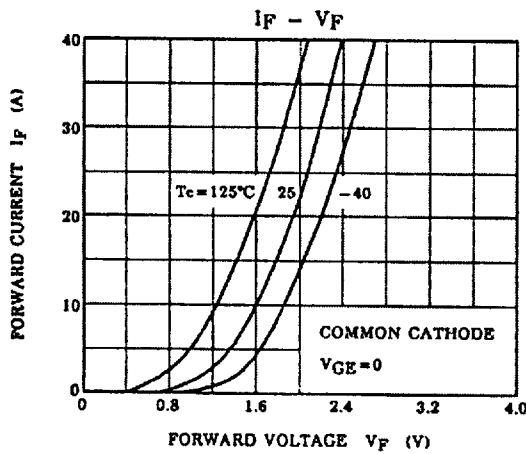
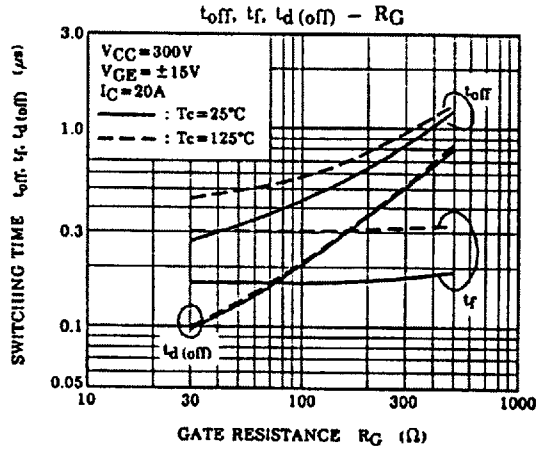
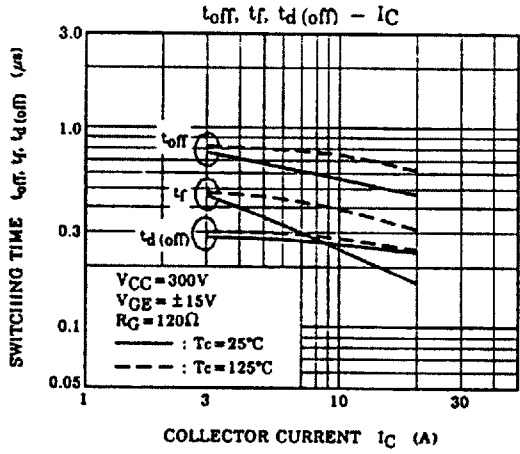
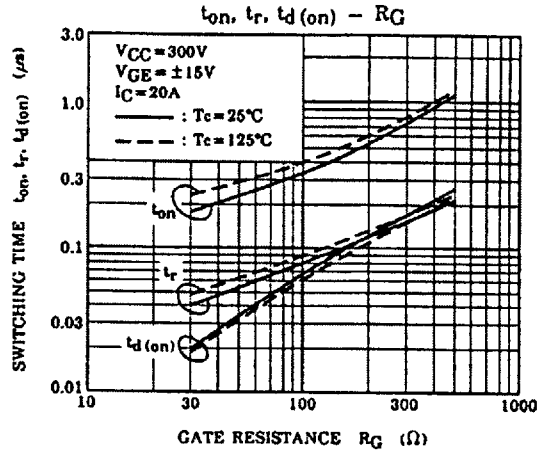
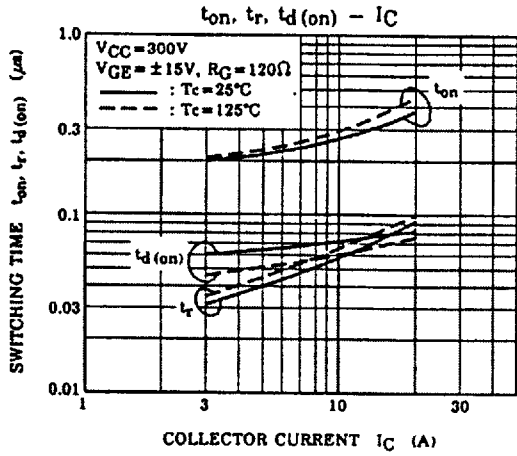

a. Inverter Stage

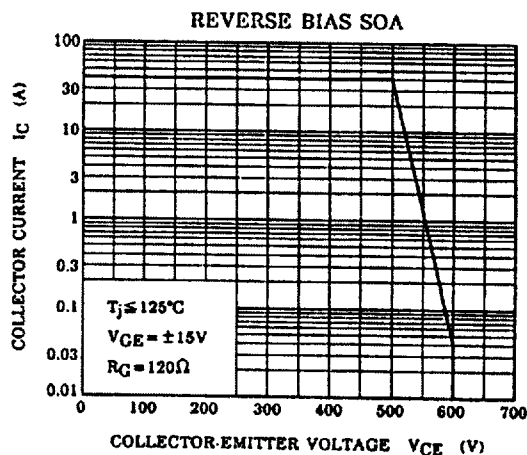
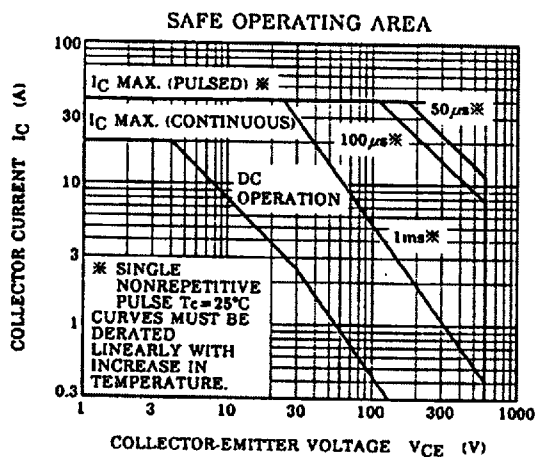
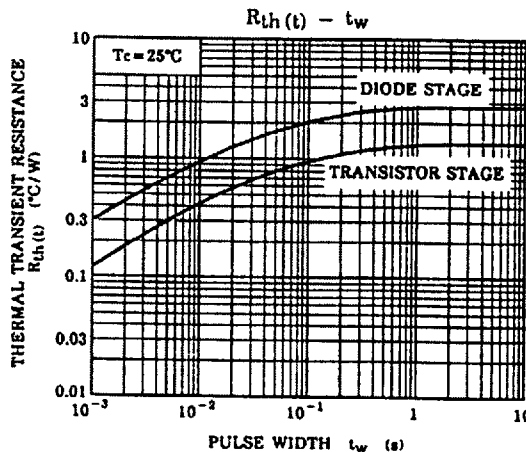
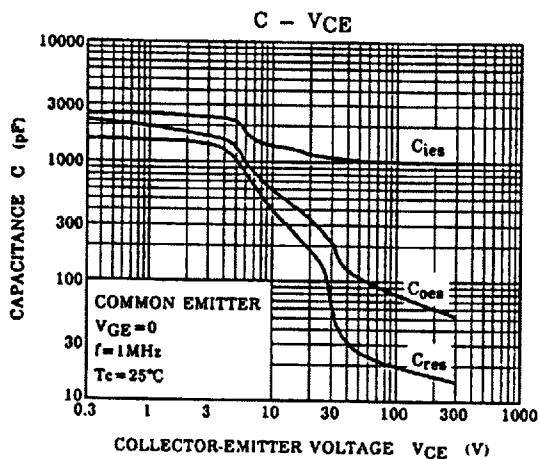

MIG20J951H

b. Converter Stage

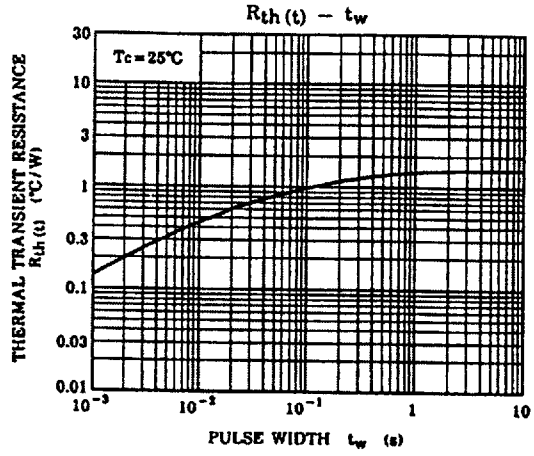
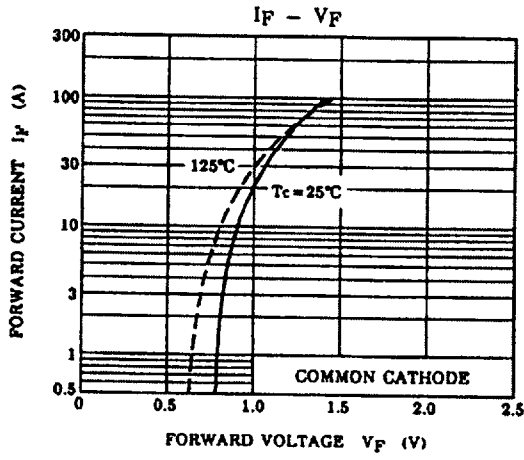

c. Brake Stage

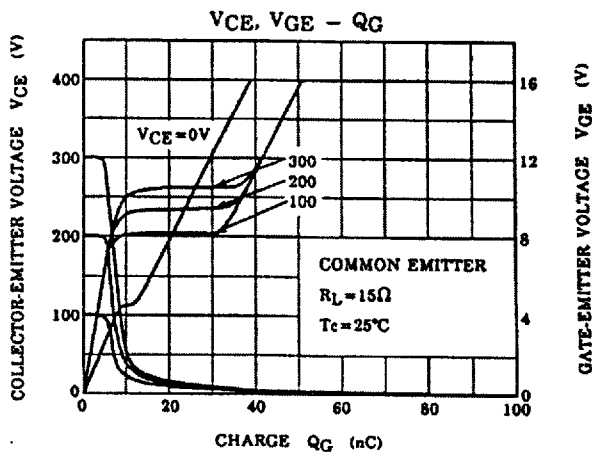
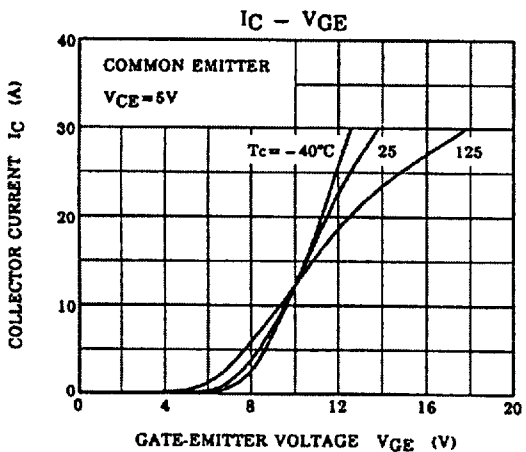
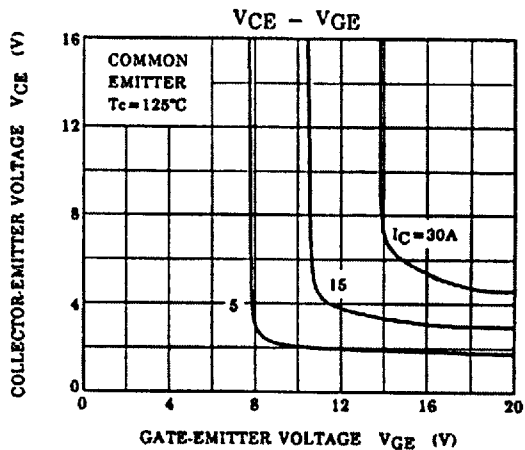
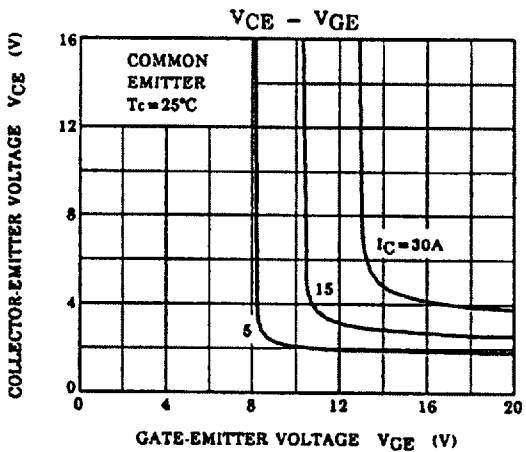
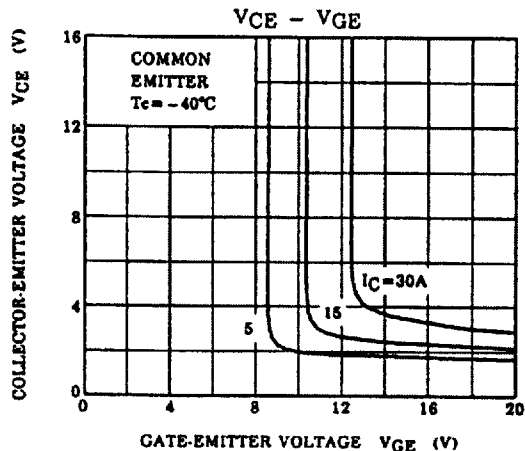
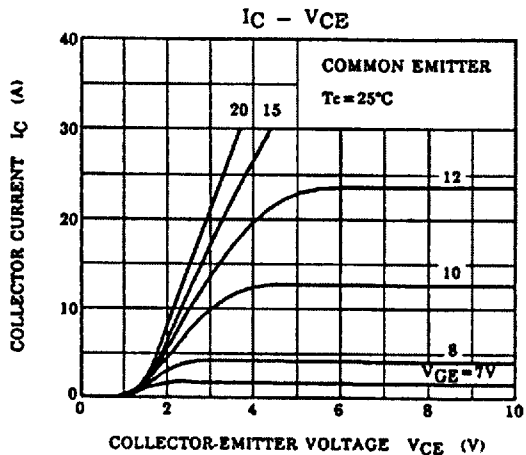

MIG20J951H

c. Brake Stage

(MIG20J951H)

c. Brake Stage

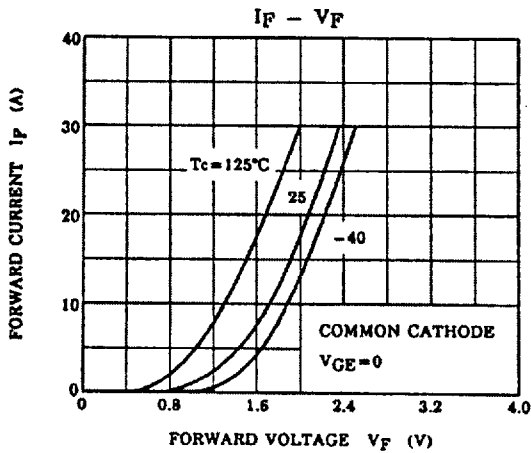
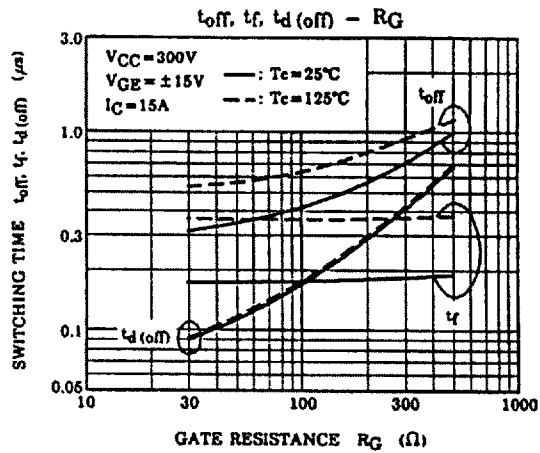
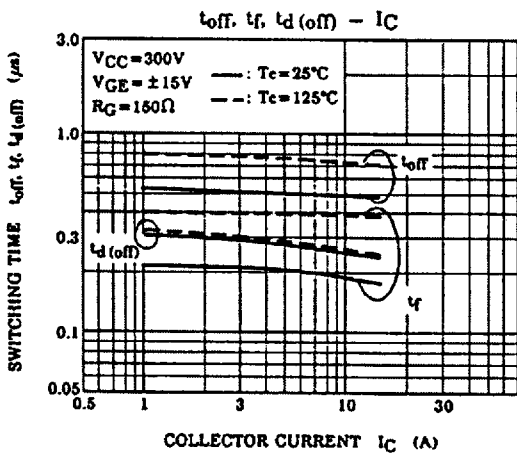
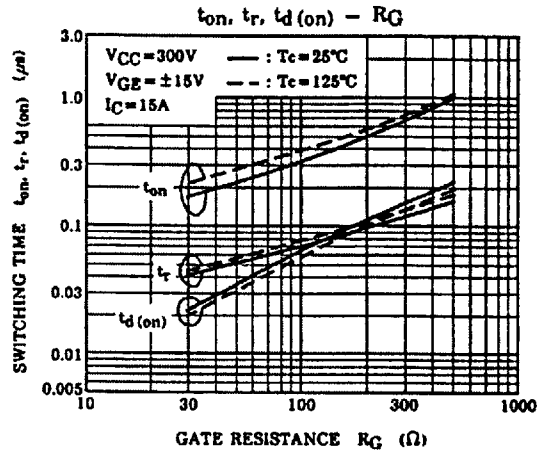
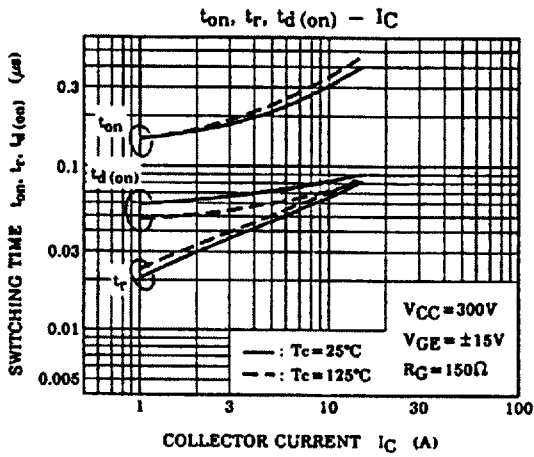

c. Brake Stage

