

TOSHIBA BIPOLAR DIGITAL INTEGRATED CIRCUIT SILICON MONOLITHIC

## TD62384AP,TD62384F,TD62384AF TD62385AP,TD62385F,TD62385AF

### 8CH LOW INPUT ACTIVE DARLINGTON SINK DRIVER

The TD62384AP / F / AF and TD62385AP / F / AF are non-inverting transistor arrays, which are comprised of eight NPN darlington output stages and PNP input stages. These devices can be operated by source input voltage and are suitable for operations with a 5-V general purposed logic IC such as 5-V TTL, 5-V CMOS and 5-V Microprocessor which have sink current output drivers. Please observe the thermal condition for using.

### FEATURES

- Output current (single output) 500 mA (Max)
- High sustaining voltage 35 V (TD62384F, 385F)  
50 V (TD62384AP / AF, 385AP / AF) (Min)
- Low level active input
- Inputs compatible with 5-V TTL and 5-V CMOS
- Package type-AP : DIP-18 pin
- Package type-F, AF : SOP-18 pin

TYPE	V <sub>IN</sub> (ON)
TD62384AP / F / AF	-20 V~V <sub>CC</sub> - 2.8 V
TD62385AP / F / AF	0 V~V <sub>CC</sub> - 3.7 V

### PIN CONNECTION (TOP VIEW)

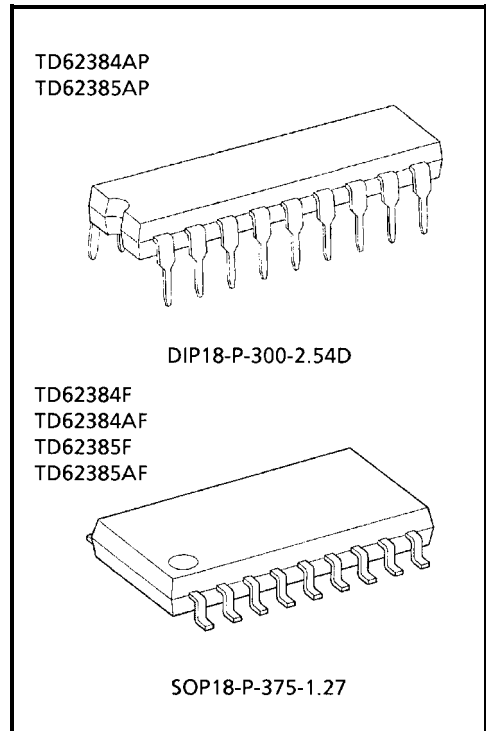
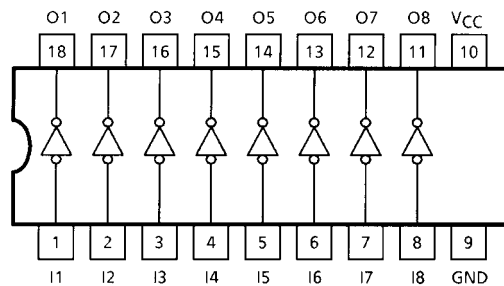

Weight  
 DIP18-P-300-2.54D : 1.47 g (Typ.)  
 SOP18-P-375-1.27 : 0.41 g (Typ.)

## SCHEMATICS (EACH DRIVER)

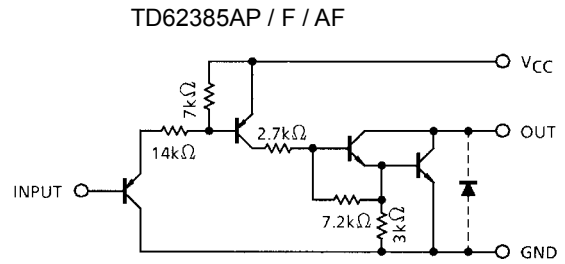
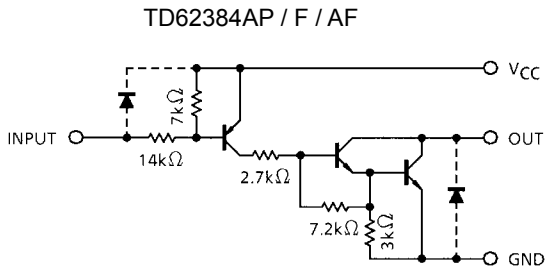

Note : The input and output parasitic diodes cannot be used as clamp diodes.

## MAXIMUM RATINGS (Ta = 25°C)

CHARACTERISTIC	SYMBOL	RATING	UNIT
Supply Voltage	V <sub>CC</sub>	-0.5~7.0	V
Output Sustaining Voltage	AP / AF	-0.5~50	V
	F	-0.5~35	
Output Current	I <sub>OUT</sub>	500	mA / ch
Input Voltage	V <sub>IN</sub> (Note 1)	-22~V <sub>CC</sub> + 0.5	V
	V <sub>IN</sub> (Note 2)	-0.5~7	
Input Current	I <sub>IN</sub>	-10	mA
Power Dissipation	AP	1.47	W
	F / AF	0.96	
Operating Temperature	T <sub>opr</sub>	-40~85	°C
Storage Temperature	T <sub>stg</sub>	-55~150	°C

Note 1: TD62384AP / AF / F

Note 2: TD62385AP / AF / F

Note 3: Delated above 25°C in the proportion of 11.7 mW / °C (AP-Type), 7.7 mW / °C (F, AF-Type).

## RECOMMENDED OPERATING CONDITIONS (Ta = -40~85°C)

CHARACTERISTIC	SYMBOL	CONDITION	MIN	TYP.	MAX	UNIT
Supply Voltage	V <sub>CC</sub>	—	4.5	5.0	5.5	V
Output Sustaining Voltage	AP / AF	—	0	—	50	V
	F	—	0	—	35	
Output Current	AP	T <sub>pw</sub> = 25 ms, Duty = 50% 8 Circuits, Ta = 85°C, Tj = 120°C	0	—	115	mA / ch
	F / AF		0	—	78	
			0	—	400	
Input Voltage	TD62384	—	-20	—	V <sub>CC</sub>	V
	TD62385		0	—	5.5	
Power Dissipation	AP	—	—	—	0.52	W
	F / AF	—	—	—	0.35	

## ELECTRICAL CHARACTERISTIC (Ta = 25°C)

CHARACTERISTIC		SYMBOL	TEST CIR-CUIT	TEST CONDITION	MIN	TYP.	MAX	UNIT
Output Leakage Current	AP / AF	I <sub>CEX</sub>	1	V <sub>CC</sub> = 5.5 V, I <sub>IN</sub> = 0, Ta = 85°C, V <sub>OUT</sub> = 50 V	—	—	100	μA
	F			V <sub>OUT</sub> = 35 V				
Output Saturation Voltage		V <sub>CE (sat)</sub>	2	V <sub>CC</sub> = 4.5 V, I <sub>OUT</sub> = 350 mA, V <sub>IN</sub> = V <sub>IN (ON) MAX.</sub>	—	1.4	2.0	V
Input Current	(Output On)	I <sub>IN (ON)</sub>	3	V <sub>CC</sub> = 5.5 V, V <sub>IN</sub> = 0.4 V	—	-0.32	-0.45	mA
				V <sub>CC</sub> = 5.5 V, V <sub>IN</sub> = -20 V	—	—	-2.6	
	(Output Off)	I <sub>IN (OFF)</sub>	4	—	—	—	-4.0	μA
Input Voltage	(Output on)	TD62384	5	—	—	—	V <sub>CC</sub> - 2.8	V
		TD62385		—	—	—	V <sub>CC</sub> - 3.7	
Supply Current		I <sub>CC (ON)</sub>	6	V <sub>CC</sub> = 5.5 V, V <sub>IN</sub> = 0	—	17	22	mA
		I <sub>CC (OFF)</sub>		V <sub>CC</sub> = 5.5 V, V <sub>IN</sub> = V <sub>CC</sub>	—	—	100	
Turn-On Delay		t <sub>ON</sub>	7	V <sub>CC</sub> = 5 V, V <sub>OUT</sub> = 50 V, R <sub>L</sub> = 163 Ω, C <sub>L</sub> = 15 pF (Note 1)	—	0.1	—	μs
Turn-Off Delay		t <sub>OFF</sub>			—	3	—	

Note 1: F-Type: V<sub>OUT</sub> = 35 V, R<sub>L</sub> = 116 Ω

## TEST CIRCUIT

### 1. $I_{CEX}$

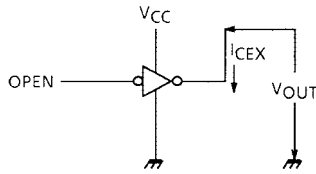

### 2. $V_{CE(sat)}$

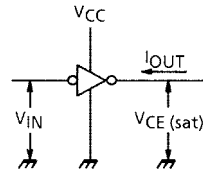

### 3. $I_{IN(ON)}$

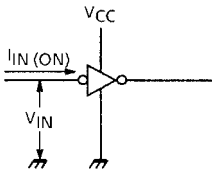

### 4. $I_{IN(OFF)}$

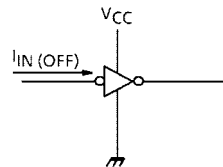

### 5. $V_{IN(ON)}$

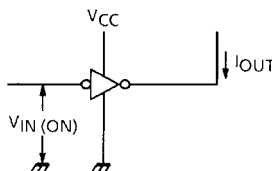

### 6. $I_{CC}$

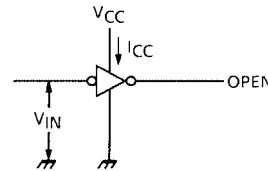

### 7. $t_{ON}, t_{OFF}$

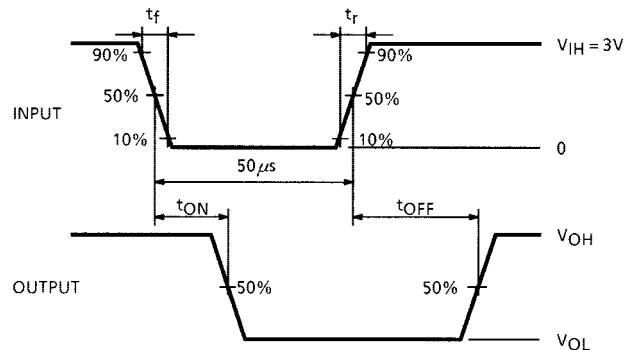
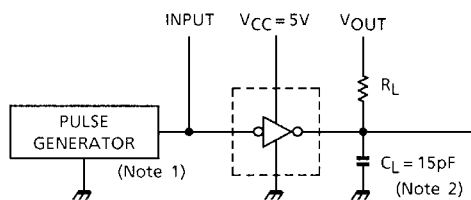

Note 1: Pulse Width 50  $\mu$ s, Duty Cycle 10%  
 Output Impedance 50  $\Omega$ ,  $t_r \leq 5$  ns,  $t_f \leq 10$  ns  
 Note 2:  $C_L$  includes probe and jig capacitance.

## PRECAUTIONS for USING

This IC does not integrate protection circuits such as overcurrent and overvoltage protectors.

Thus, if excess current or voltage is applied to the IC, the IC may be damaged. Please design the IC so that excess current or voltage will not be applied to the IC.

Utmost care is necessary in the design of the output line, VCC and GND line since IC may be destroyed due to short-circuit between outputs, air contamination fault, or fault by improper grounding.

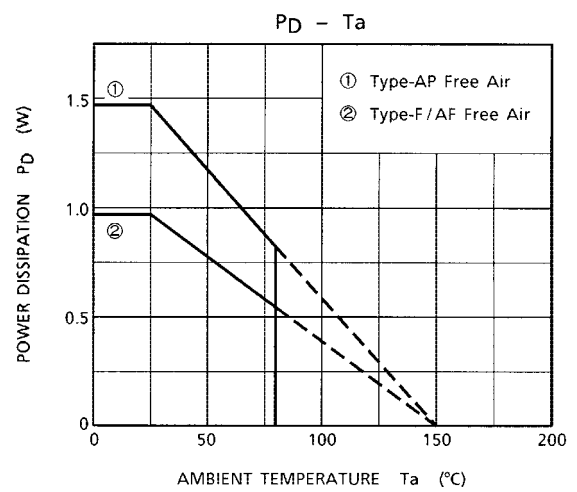
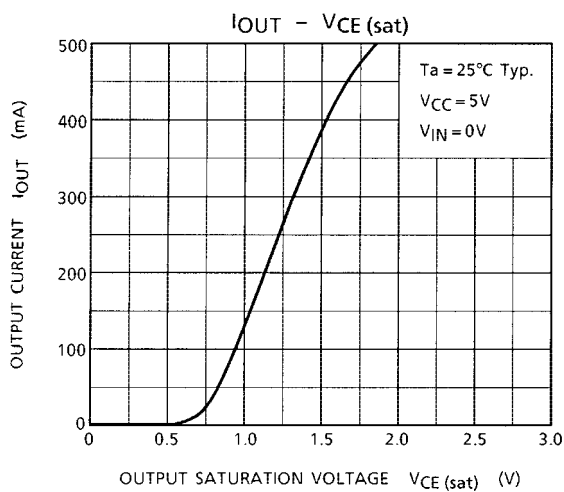
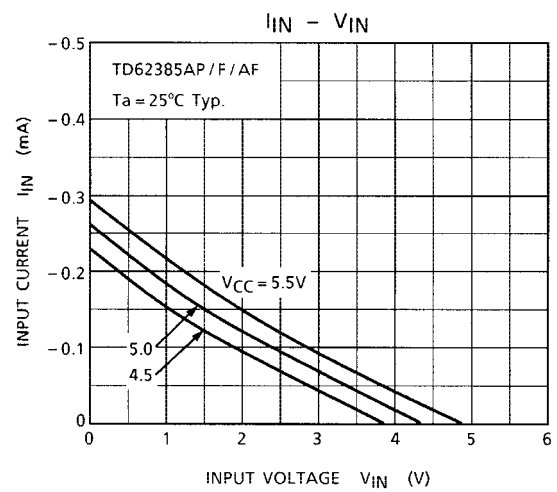
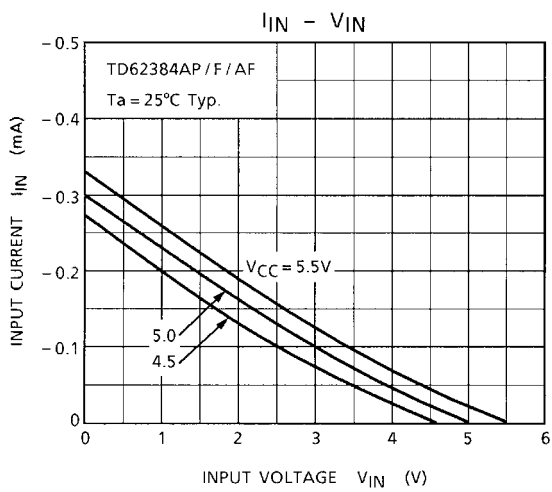
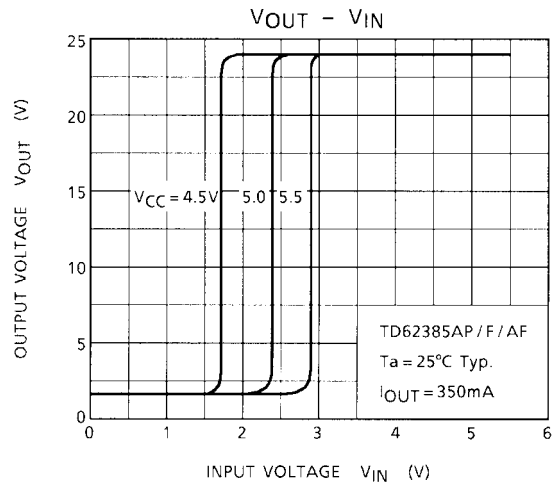
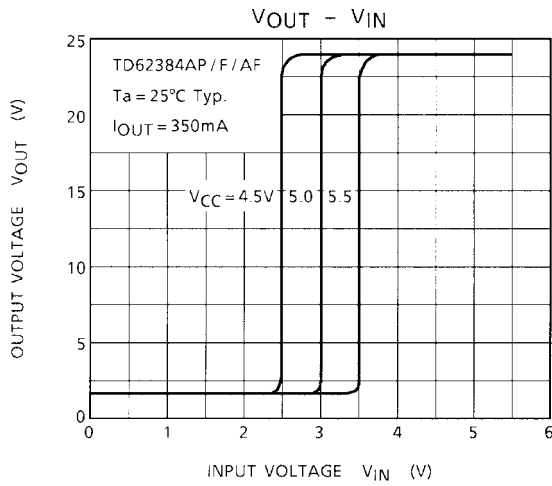

## PACKAGE DIMENSIONS

DIP18-P-300-2.54D

Unit: mm

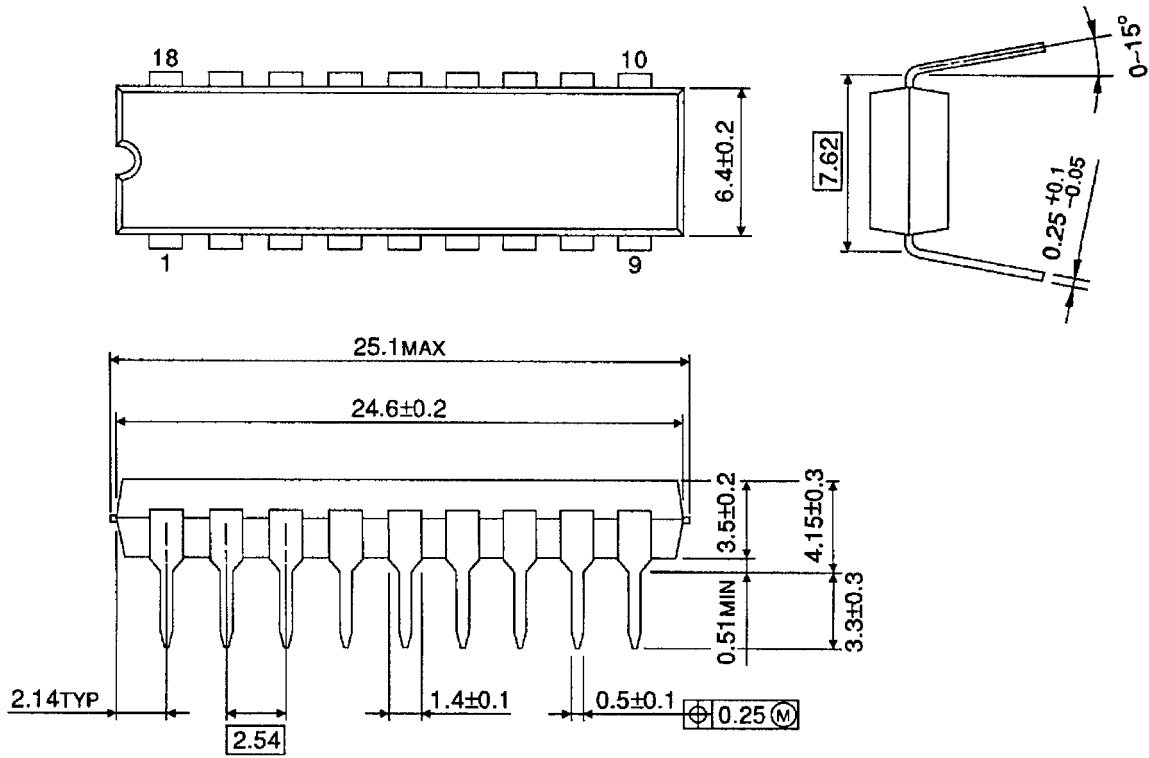

Weight: 1.47 g (Typ.)

## PACKAGE DIMENSIONS

SOP18-P-375-1.27

Unit: mm

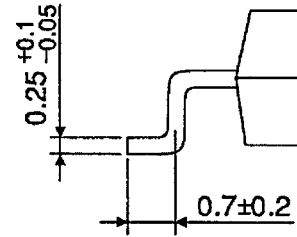
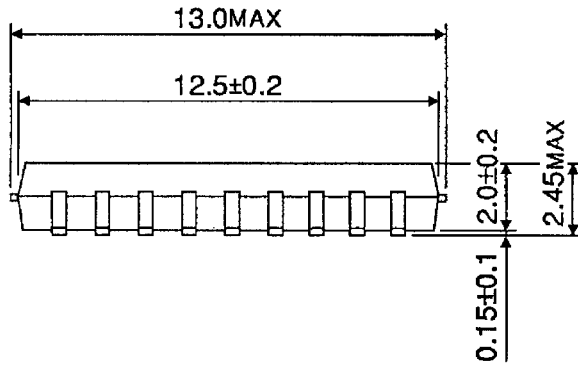
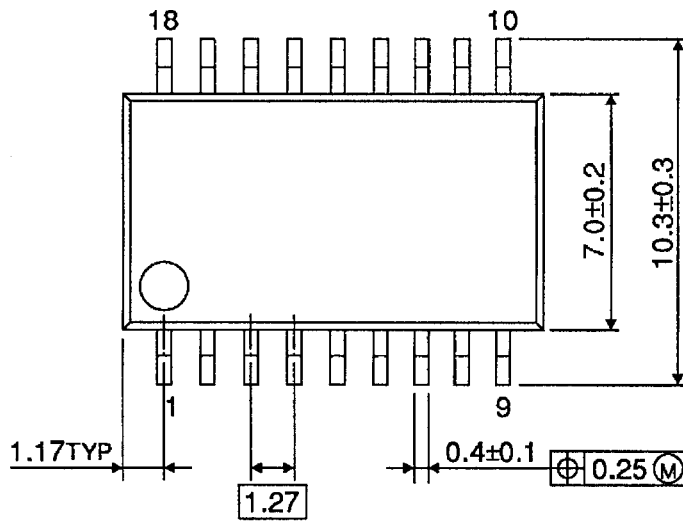

Weight: 0.41 g (Typ.)

**RESTRICTIONS ON PRODUCT USE**

000707EBA

- TOSHIBA is continually working to improve the quality and reliability of its products. Nevertheless, semiconductor devices in general can malfunction or fail due to their inherent electrical sensitivity and vulnerability to physical stress. It is the responsibility of the buyer, when utilizing TOSHIBA products, to comply with the standards of safety in making a safe design for the entire system, and to avoid situations in which a malfunction or failure of such TOSHIBA products could cause loss of human life, bodily injury or damage to property.  
In developing your designs, please ensure that TOSHIBA products are used within specified operating ranges as set forth in the most recent TOSHIBA products specifications. Also, please keep in mind the precautions and conditions set forth in the "Handling Guide for Semiconductor Devices," or "TOSHIBA Semiconductor Reliability Handbook" etc..
- The TOSHIBA products listed in this document are intended for usage in general electronics applications (computer, personal equipment, office equipment, measuring equipment, industrial robotics, domestic appliances, etc.). These TOSHIBA products are neither intended nor warranted for usage in equipment that requires extraordinarily high quality and/or reliability or a malfunction or failure of which may cause loss of human life or bodily injury ("Unintended Usage"). Unintended Usage include atomic energy control instruments, airplane or spaceship instruments, transportation instruments, traffic signal instruments, combustion control instruments, medical instruments, all types of safety devices, etc.. Unintended Usage of TOSHIBA products listed in this document shall be made at the customer's own risk.
- The products described in this document are subject to the foreign exchange and foreign trade laws.
- The information contained herein is presented only as a guide for the applications of our products. No responsibility is assumed by TOSHIBA CORPORATION for any infringements of intellectual property or other rights of the third parties which may result from its use. No license is granted by implication or otherwise under any intellectual property or other rights of TOSHIBA CORPORATION or others.
- The information contained herein is subject to change without notice.



This datasheet has been download from:

[www.datasheetcatalog.com](http://www.datasheetcatalog.com)

Datasheets for electronics components.