

iMOTION™ Link User Manual

iMOTION™ programming, debugging and tuning tool

Quality requirement category: Industry

Features

- Programming of firmware and parameters file for IMC10xT / IMM10xT / IMC30xA / IMD11xT devices
- Tuning of motor parameters via virtual UART
- Programming and debugging application code for programmable iMOTION™ devices via standard SWD or Infineon's SPD interface
- All interfaces are galvanically isolated
- 3.3 V_{DC} output voltage to target board
- USB interface to PC for power and data
- Based on SEGGER J-Link Technology

Supported Devices

- iMOTION™ IMC10xT
- iMOTION™ IMM10xT
- iMOTION™ IMC30xA
- iMOTION™ IMD11xT

iMOTION™ Link will support all future iMOTION™ motor control ICs. For full list of supported devices, visit www.infineon.com/imotion-link

Description

iMOTION™ Link is designed to program and debug IMC10xT / IMM10xT / IMC30xA / IMD11xT series iMOTION™ motor control ICs, and all future iMOTION™ devices on user's target board (final application board) or on iMOTION™ evaluation boards without on-board debugger.

The iMOTION™ Link can also be used for motor and inverter board parameter tuning via the USB to UART interface.

Corresponding PC tool (MCEDesigner_v2.0.0.0 or above version) which is required to use iMOTION™ link is available for download on the <http://www.infineon.com/imotion-software> web page.

Third party IDEs, for example Keil MDK-ARM and IAR Embedded Workbench are also supported by the iMOTION™ Link.

Table of contents

1	Introduction.....	3
2	iMOTION™ Link technical information	6
2.1	Hardware description	6
2.2	Components placement and geometry	6
2.3	Schematics	7
2.4	Bill Of Material	9
3	Driver software requirements for iMOTION™ Link	10
3.1	Using iMOTION™ Link with MCEDesigner	10
3.2	Using iMOTION™ Link with standard ARM® IDEs	12
4	iMOTION™ Link Getting Started Guide	13
4.1	Getting Started with MCE Designer	13
4.1.1	Downloading MCE software for target device.....	13
4.1.2	PC port configuration.....	13
4.1.3	Programming target device	15
4.2	Using iMOTION™ Link with standard ARM® IDEs	17
4.2.1	PC port configuration.....	17

Introduction

1 Introduction

iMOTION™ Link is an isolated debug probe for the new generation of iMOTION™ motor control ICs which is used to program, configure and parametrize iMOTION™ motor control ICs on the user’s target board (final application board) or on corresponding Evaluation Kits. It is also used as a debug probe for programmable ARM® core integrated in some iMOTION™ devices.

iMOTION™ Link is having following functional characteristics:

- Power: 5V DC power supply (Powered through USB interface)
- PC interface: USB to virtual communication port and IMC device debug port
- Isolated 3.3V Output for target board (switchable)
- Isolated input/output interfaces

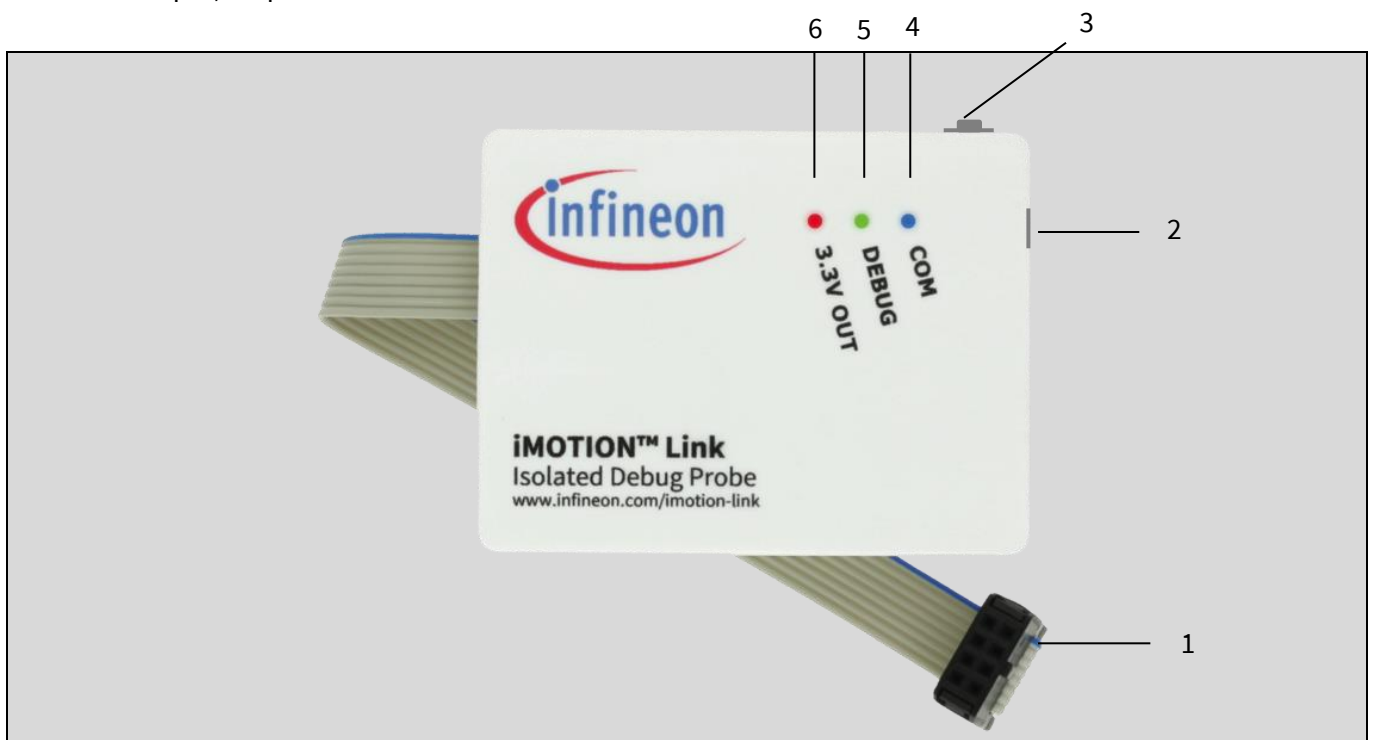

Figure 1 iMOTION™ Link top view

Figure 1 is displaying main parts of iMOTION™ Link debug probe:

1. Isolated 8-pin iMOTION™ debug connector
2. PC to Micro USB cable port for debug and virtual COM operation
3. Switch SW: Provides 3.3V to target board
4. Blue LED: Indicates virtual COM communication is initialized by PC software
5. Green LED: Indicates code debug function is initialized by PC IDE software
6. Red LED: Indicates if 3.3V output to target board is ON or OFF.

Introduction

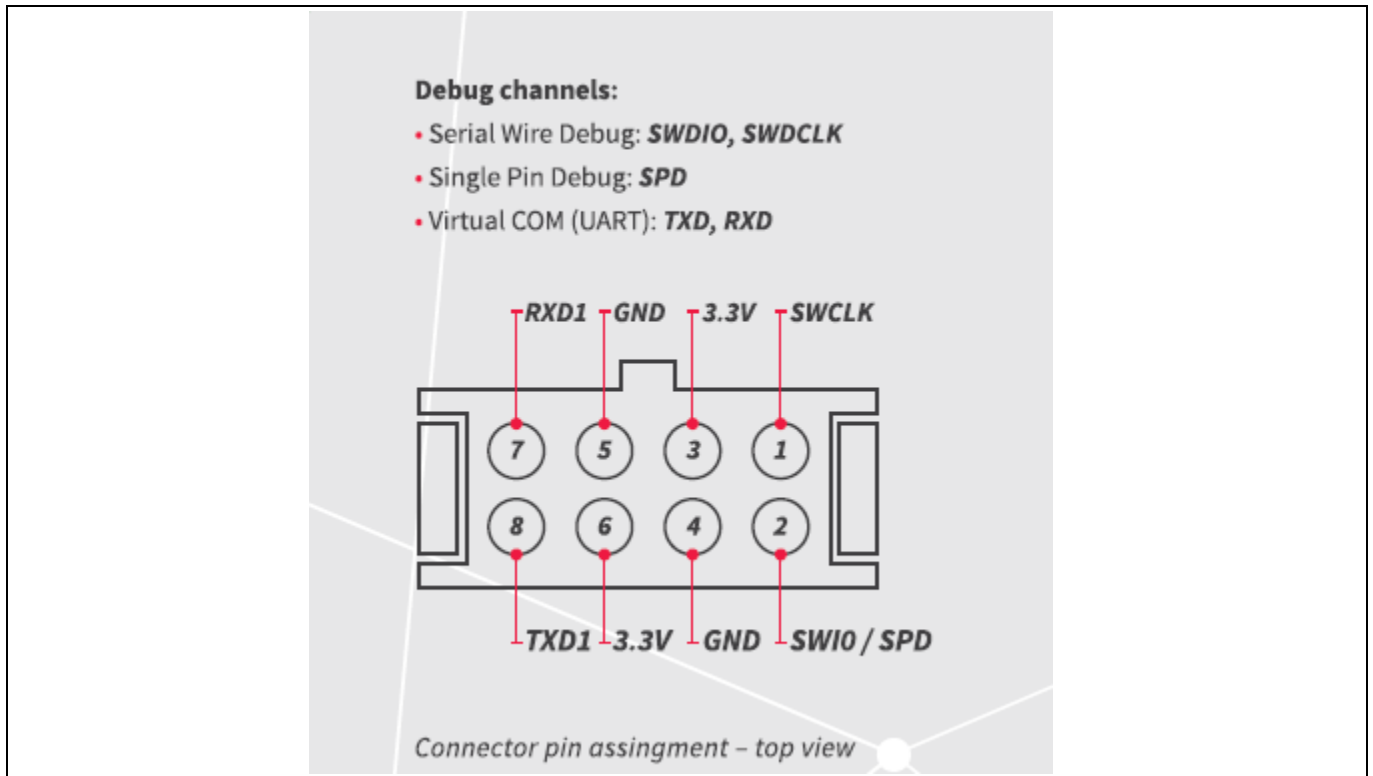

Figure 2 8-pin iMOTION™ Debug Connector (2 x 4 pin, 0.1”, 2.54mm) pinout

Figure 2 and Table 1. Provide more information about the 8-pin Debug Connector of iMOTION™ Link debug probe.

Pin	Function	Description
1	SWCLK	SerialWire Clock
2	SWIO	SerialWire Data
3	VDD	Power Supply VDDP 3.3 V
4	GND	Ground (VSS)
5	GND	Ground (VSS)
6	VDD	Power Supply VDDP 3.3 V
7	RXD1	Transmission line of PC/laptop, receive line of iMOTION™ device
8	TXD1	Receive line of PC/laptop, transmission line of of iMOTION™ device

Table 1. 8-pin iMOTION™ connector pin description

Switch SW enables iMOTION™ Link to power target board with 3.3V DC voltage galvanically isolated from the 5V voltage supplied by the USB connector (and PC). This option covers the use case when the targeted board does not have power stage (which typically provides 3.3V DC voltage to the controller) connected, or powered, and user wants to do some programming, or testing on the standalone controller, in the safe, low voltage environment.

Introduction



Figure 3 iMOTION™ Link “3.3V OUT” switch

2 iMOTION™ Link technical information

This chapter describes the hardware details of the iMOTION™ Link. iMOTION™ Link is an isolated debug probe for all IMC™ microcontrollers.

2.1 Hardware description

The hardware is depicted in Figure 4.

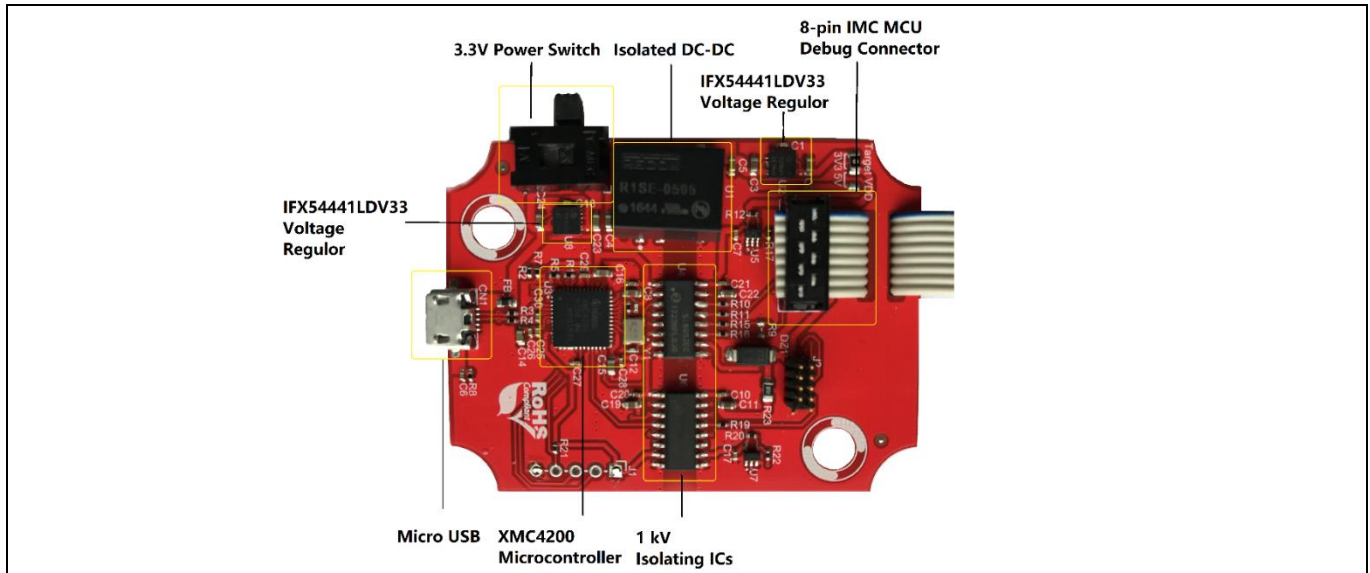

Figure 4 PCB of the iMOTION™ Link

2.2 Components placement and geometry

Figure 5 shows the board dimensions and the placement of components on the PCB in hardware version 1.01.

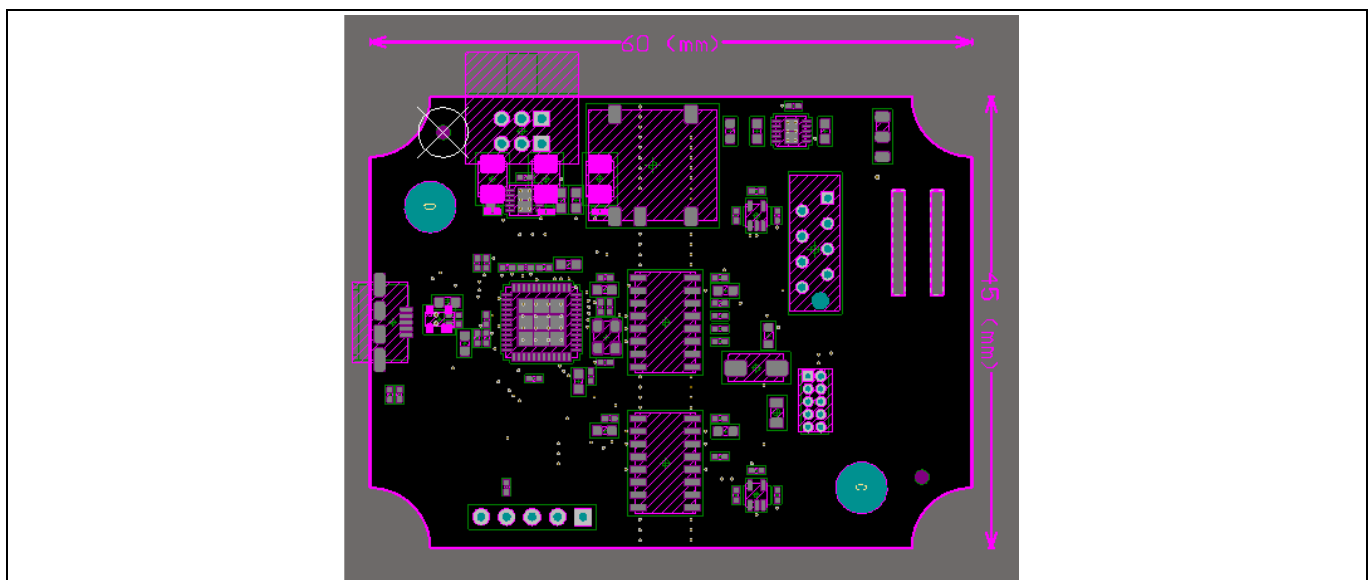

Figure 5 Components placement and geometry

2.3 Schematics

Figure 6 shows the schematics of iMOTION™ Link in hardware version 1.1.

Important Note:

Schematics and the BOM list on pages 8 and 9 correspond to the iMOTION™ Link hardware revision 1.1. The difference between revisions 1.0 and 1.1 is that in revision 1.1 the resistor R1 is not mounted. This modification has eliminated some instabilities in the communication between the iMOTION™ Link tool and iMOTION™ ICs which were observed occasionally under certain power-up conditions.

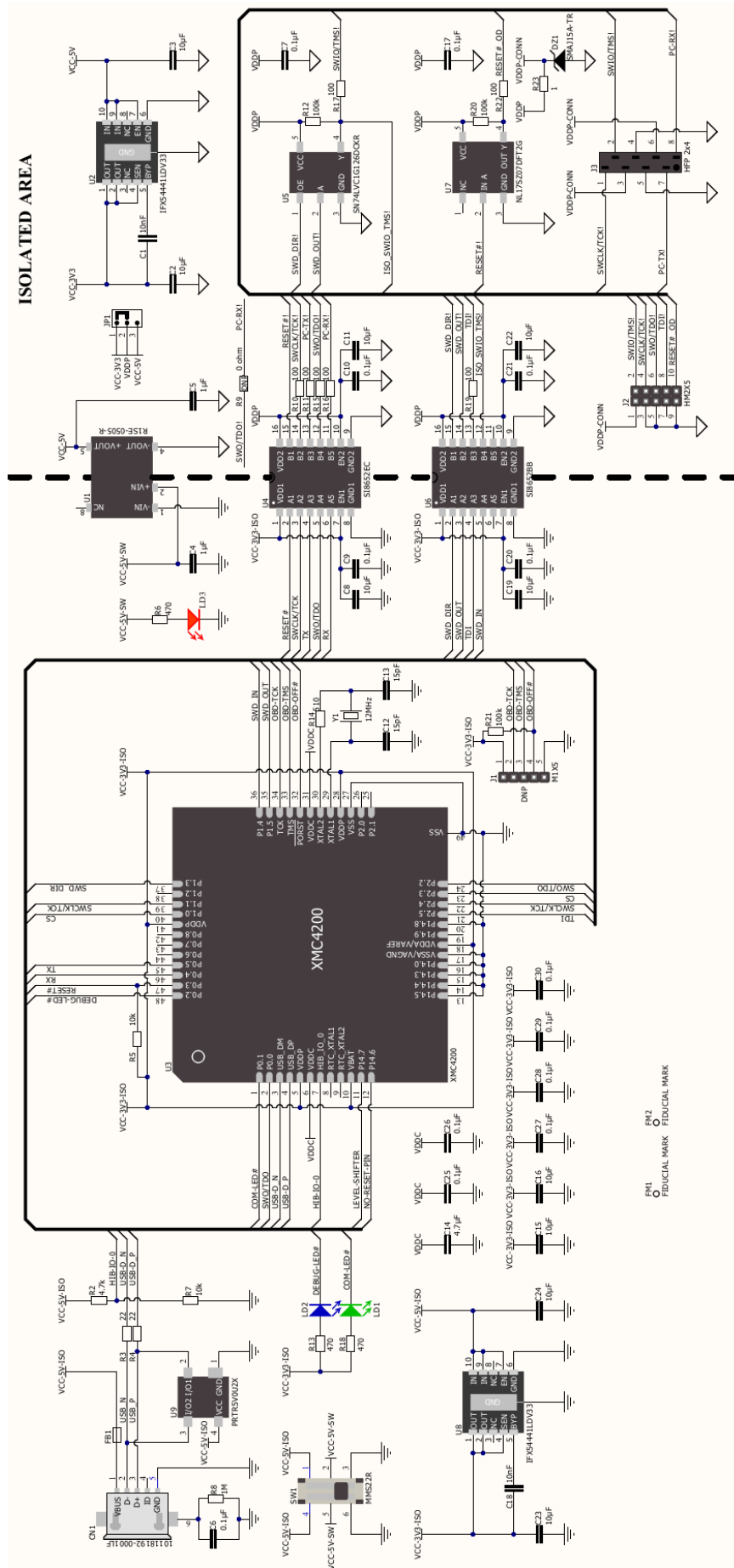

Figure 6 Schematic of the iMOTION™ Link (Hardware Version 1.01)

2.4 Bill Of Material

The Bill Of Material (BOM) is valid for the iMOTION™ Link in hardware version1.1.

Table 2 iMOTION Link BOM

Value	Device	Quantity	Reference Designator
0R 1% 0805	Resistor	1	JP1
1R 1% 0805	Resistor	1	R23
100R 1% 0402	Resistor	7	R10, R11, R15, R16, R17, R19, R22
100K 1% 0402	Resistor	3	R12, R20, R21
100nF 10V ±10% 0402	Capacitor X5R	13	C10, C17, C20, C21, C25, C26, C27, C28, C29, C30, C6, C7, C9
10K 1% 0402	Resistor	2	R5, R7
10nF 50V ±10% 0402	Capacitor X7R	2	C1, C18
10uF 6.3V ±20% 0603	Capacitor X5R	10	C11, C15, C16, C19, C2, C22, C23, C24, C3, C8
15pF 50V ±5% 0402	Capacitor NP0	2	C12, C13
16K9 1% 0402	Resistor	1	R6
1M 1% 0402	Resistor	1	R8
1uF 10V ±10% 0603	Capacitor X5R	2	C4, C5
22R 1% 0402	Resistor	2	R3, R4
2K94 1% 0402 SMD	Resistor	1	R18
4.7uF 10V -20%, +80% 0603	Capacitor Y5V	1	C14
470R 1% 0402	Resistor	1	R13
4K7 1% 0402	Resistor	1	R2
510R 1% 0402	Resistor	1	R14
2178713-8 2x4pin 0.1"	Ribbon Cable, DIP Header	1	J3
12MHz 3.2x2.5	Crystal 12Mhz 4Pad NX3225SA 12MHZ NDK	1	Y1
R1SE-0505-R	DC/DC CONVERTER 1W 5VIN 5VOUT Recom Power	1	U1
SI8652BB-B-IS1R NB-SOIC-16	Isolation IC Silicon Labs	1	U6
SI8652EC-B-IS1 NB-SOIC-16	Isolation IC Silicon Labs	1	U4
60R 500mA 0603	Ferrite Bead BLM18PG600SN1D Murata	1	FB1
20021111-00010T4LF 2x5pin 0.05"	Pin Header Amphenol FCI	1	J2
NL17SZ07DFT2G SOT353	Non-Inverting Buffer with Open Drain Output ON Semiconductor	1	U7
SN74LVC1G126DCKR SC705	Single Bus Buffer Gate With 3-State Output Texas Instruments	1	U5
CA2108SA100 2x4pin 0.1"	IDC socket for flat cable 0.05" CviLux	1	N/A - Mounted on the cable
IFX54441LDV33XUMA1 10TSON	Voltage Regulator 3.3 V Infineon	2	U2, U8
JSL-3528UBW PLCC-2	LED Blue	1	LD1
JSL-3528UGW PLCC-2	LED Green	1	LD2
JSL-3528URW PLCC-2	LED Red	1	LD3
10118192-0001LF	Connector Micro USB AB SMD Amphenol FCI	1	CN1
MMS22R	SLIDE SWITCH 300MA 30V Apem Inc.	1	SW1
SMAJ15A-TR SMA	TVS DIODE STMicroelectronics	1	DZ1
PRTR5V0U2X,215 SOT143B	TVS Diode Nexperia USA Inc.	1	U9
XMC4200-Q48K256 QFN48	Microcontroller XMC4200 Infineon	1	U3

3 Driver software requirements for iMOTION™ Link

There are 2 options for communicating between PC and iMOTION™ motor control ICs. First option is to use Infineon's MCEDesigner tool, for configuring and tuning of iMOTION™ IC, as well as doing firmware updates. Second option (for iMOTION™ devices which have integrated system controller based on ARM® Cortex® core) is to use industry standard ARM® Cortex® IDEs to program and debug the system controller. For both these options the installation of the J-Link Driver on the PC is required.

3.1 Using iMOTION™ Link with MCEDesigner

iMOTION™ Link needs J-Link virtual com port driver to connect with MCEDesigner. J-Link driver is automatically installed on user's PC during the installation procedure for MCEDesigner.

MCEDesigner installation package is available for download from the www.infineon.com/imotion-software website and contains all the necessary components for using iMOTION™ Link probe. Below is description of the steps that need to be executed in order to install MCEDesigner.

Note: Following description is based on the use of the all-in-one installation package "MCEDesigner". The installation procedure might differ slightly if individual installation files are used for the software tools above.

Step 1: Double click on the "MCEDesigner_v2.0.0.0.exe" (or later version) file. The installation process will check if the PC already has installed some version the software, and then it will go to the next step.



Figure 7 Welcome page for MCEDesigner software installation

Step 2: After verifying existing software installations, the installation process will start.

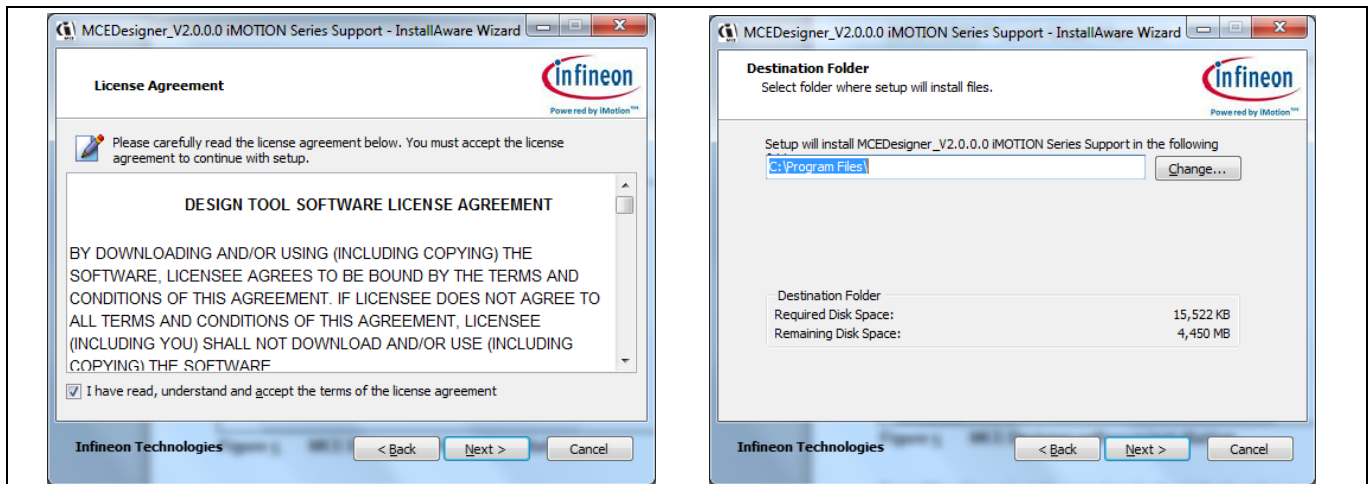

Figure 8 MCE Designer software installation

Press “Next” to select the install path, the default path is C:\Program Files\Infineon. Following dialog screens will appear.

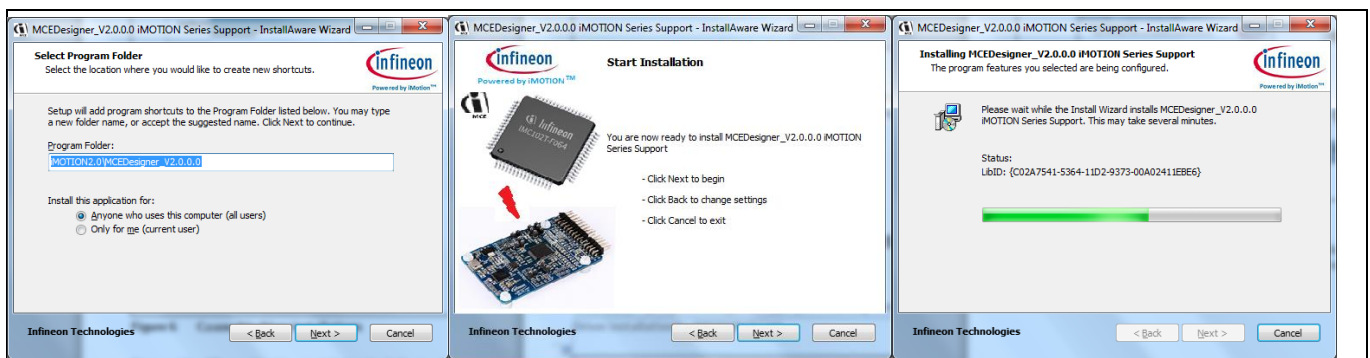

Figure 9 MCE Designer software with J-Link virtual driver installations

Step 3: After installation the confirmation message “MCEDesigner_v2.0.0.0 iMOTION Series Support has been successfully installed” will appear. Press “Finish” to exit the installation wizard. After installation, the J-Link driver will be installed on users’s PC.



Figure 10 Installation completed message

3.2 Using iMOTION™ Link with standard ARM® IDEs

iMOTION™ Link is supported by Keil MDK-ARM and IAR Embedded Workbench IDEs. The installation procedure for iMOTION™ Link the installation of the J-Link Driver is as follows.

1. Download the latest version of “J-Link Software and Documentation pack for Windows” from <https://www.segger.com/downloads/jlink> and install it on your PC.
Note: The J-Link virtual UART driver is also part of the typical installation of MCEDesigner and 3rd party tools supporting SEGGER JLink.
2. Connect iMOTION™ Link with your PC using the Micro USB cable.
3. A proper connection and installation of the J-Link driver is indicated by a constantly illuminated DEBUG LED.
4. Connect your iMOTION™ target board with iMOTION™ Link using one of the enclosed cables.
5. Select SEGGER J-Link as debugger in your preferred IDE e.g. ARM MADK
6. Start the programming and debugging session

4 IMOTION™ Link Getting Started Guide

4.1 Getting Started with MCE Designer

4.1.1 Downloading MCE software for target device

Depending on the target iMOTION™ device, corresponding MCE Software Package (e.g. “IMC101T-F064 MCE Software Package”) file needs to be downloaded and saved to user’s project directory. All software package files as well as iMOTION™ software tools can be found on www.infineon.com/imotion-software website.

4.1.2 PC port configuration

In order to establish the communication between MCEDesigner and target board through iMOTION™ Link, following steps need to be executed:

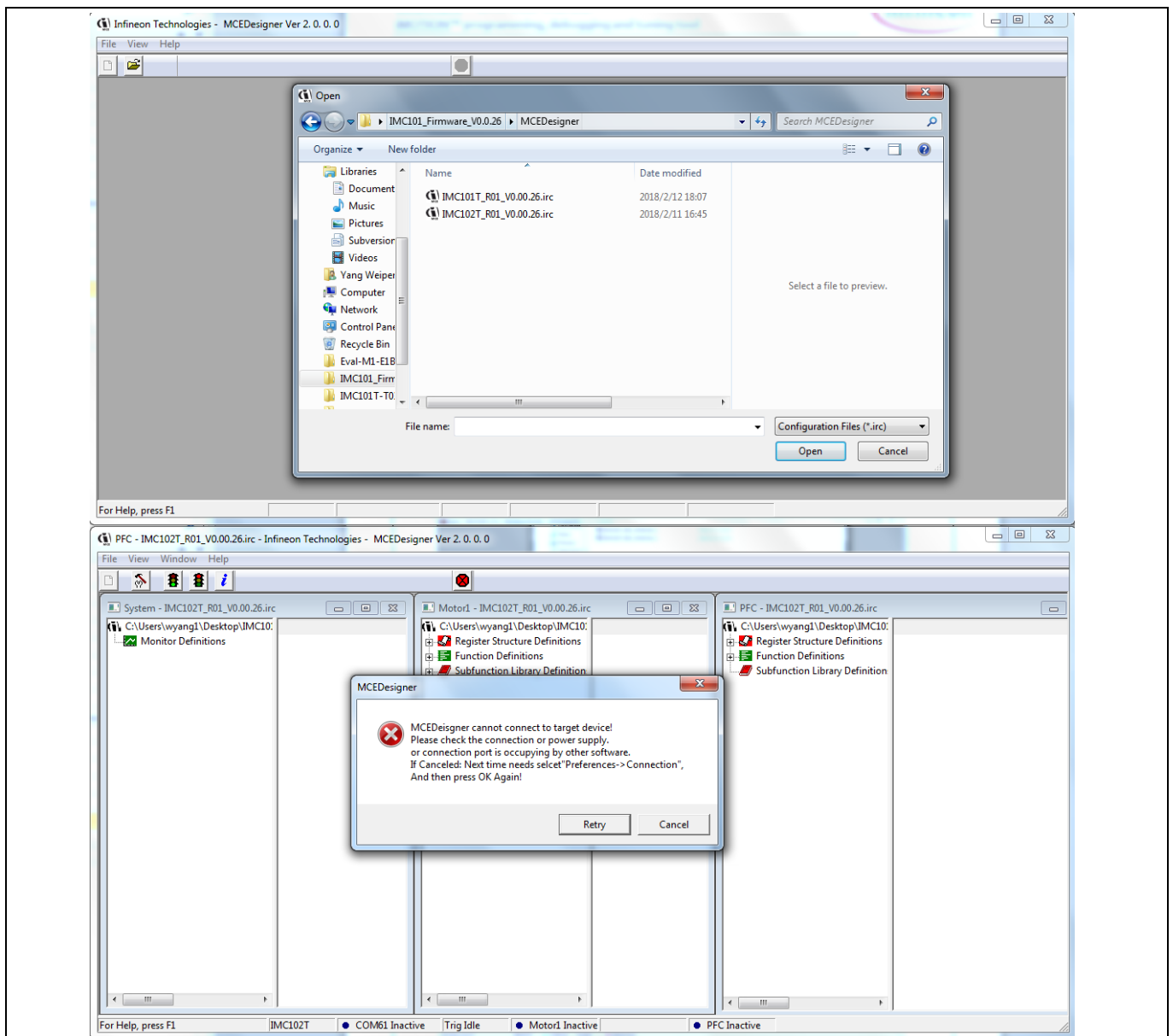

Figure 11 Configuration file selection

1. Launch MCE Designer and open one of the available configuration files (with extension .irc). Configuration file comes as a part of “IMCxxx MCE Software Package” downloaded earlier. This is the default configuration file for the particular device. The actual system configuration of any particular system will differ from the defaults configuration file to the certain extent, and it is recommended that user saves the actual .irc file for further use. System will prompt user to save the .irc file at several points in the process, and the user can save it any time by choosing “File” > “Save As...” option.
2. It is possible that the default COM port does not match with the configured COM port number on the PC, and the message “MCEDesigner cannot connect to target device” will appear (as in Figure 11). In that case, press Cancel, Highlight or click “System – XXX.irc” sub-window and select “Preferences → Connection”. Then select proper COM port from drop down list and press “OK” button.

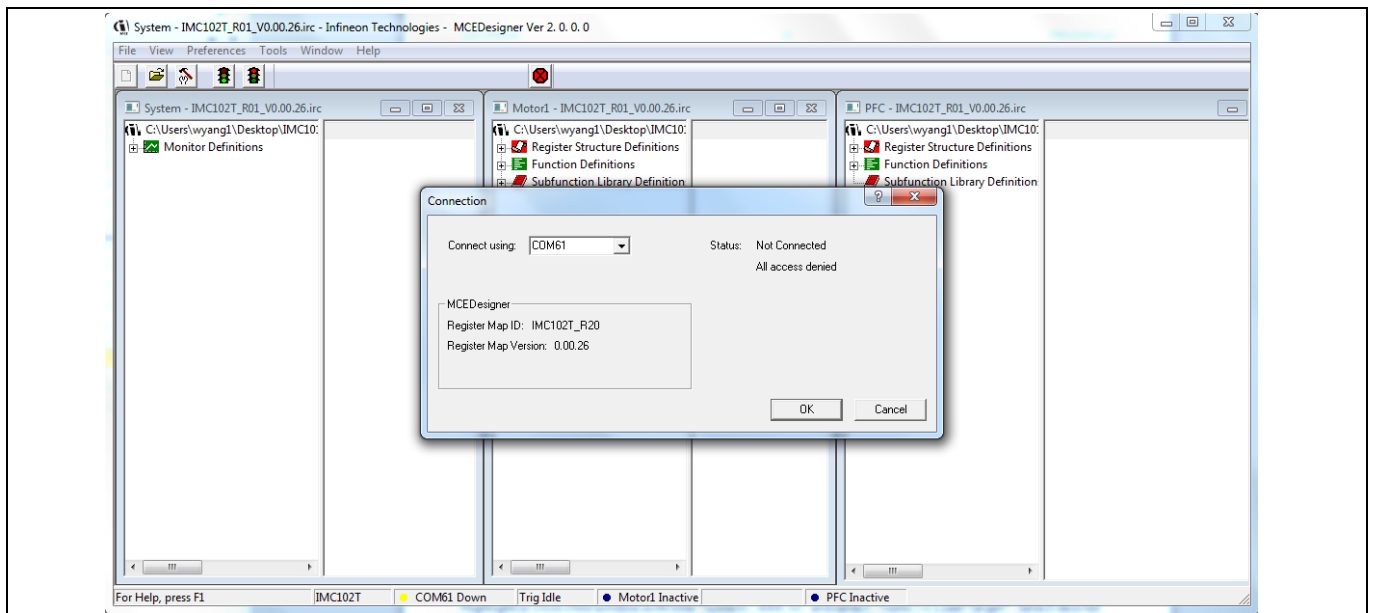

Figure 12 COM port selection

4.1.3 Programming target device

In order to operate “T” versions of iMOTION™ motor control ICs (without programmable system controller), 2 different files need to be programmed into iMOTION™ controller: Firmware file (.ldf) and parameter file (.txt or .ldf extension). Following steps are required to program these files into iMOTION™ controller:

1. Highlight or click “System – XXX.irc” sub-window and select “Tools → Programmer”.
2. Select desired firmware file (with .ldf extension) or parameters file (with .txt or .ldf extension) using “Browse..” button, press “Open” button in file selection dialog and then “Start” button in “IMC Programmer” dialog.

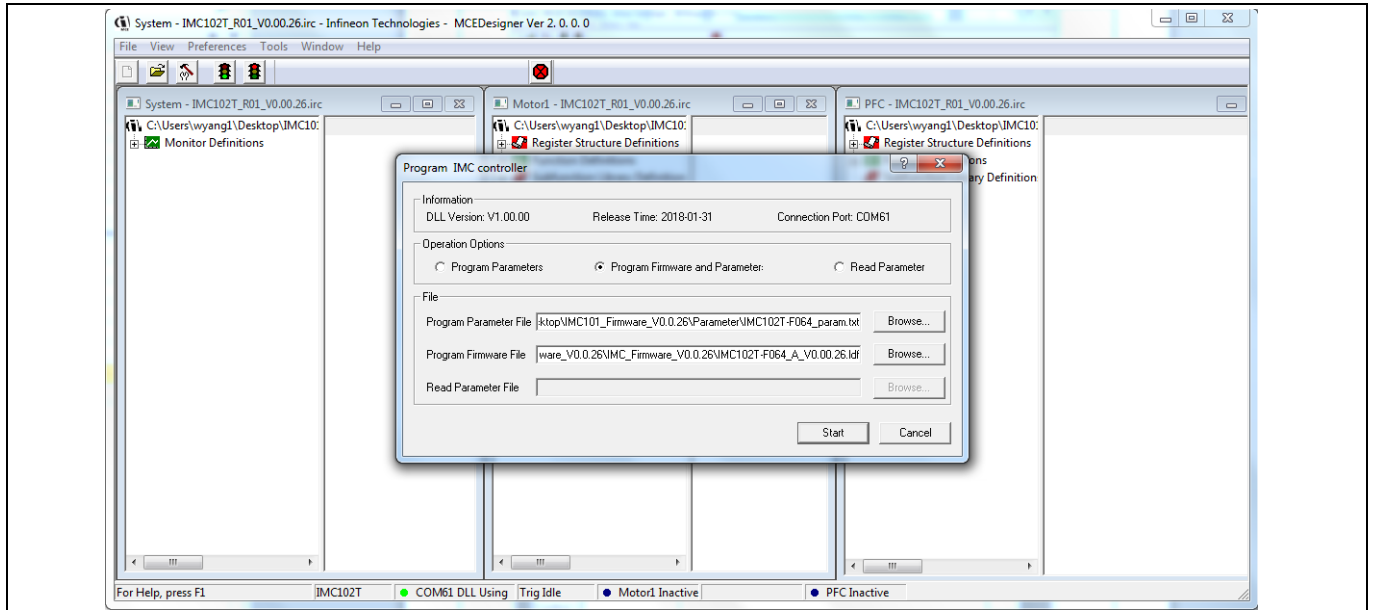

Figure 13 Firmware file selection

Programming of these files will take several seconds (see Figure 14)

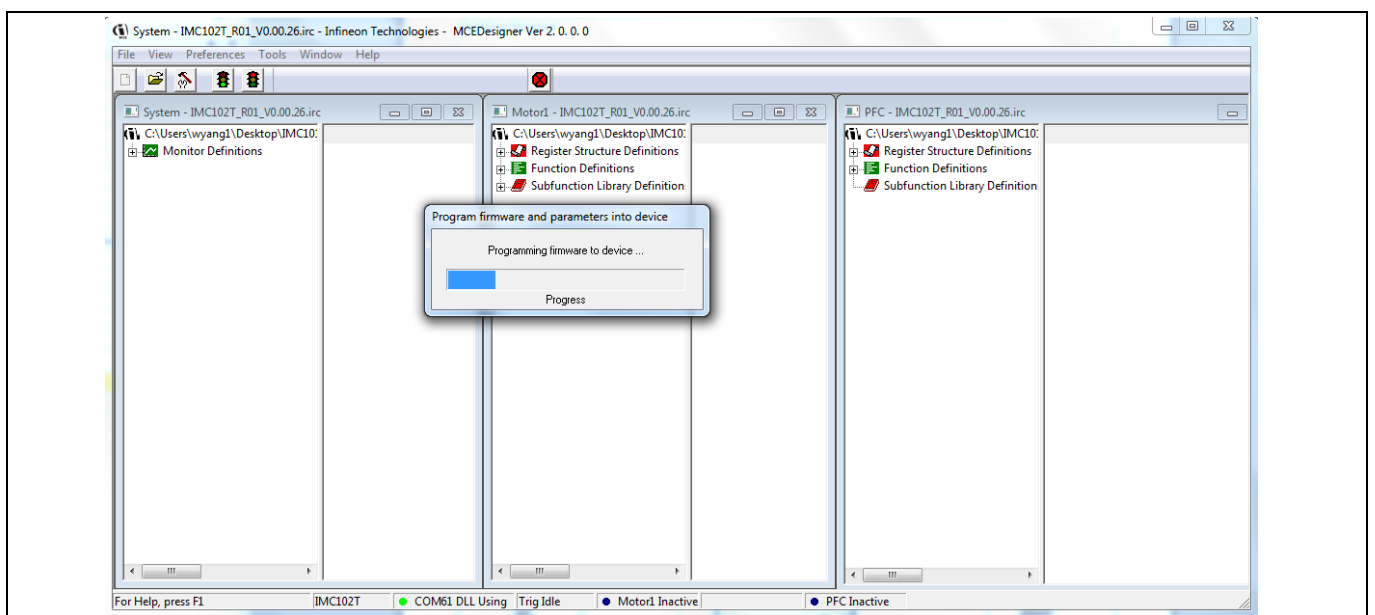

Figure 14 Programming in progress

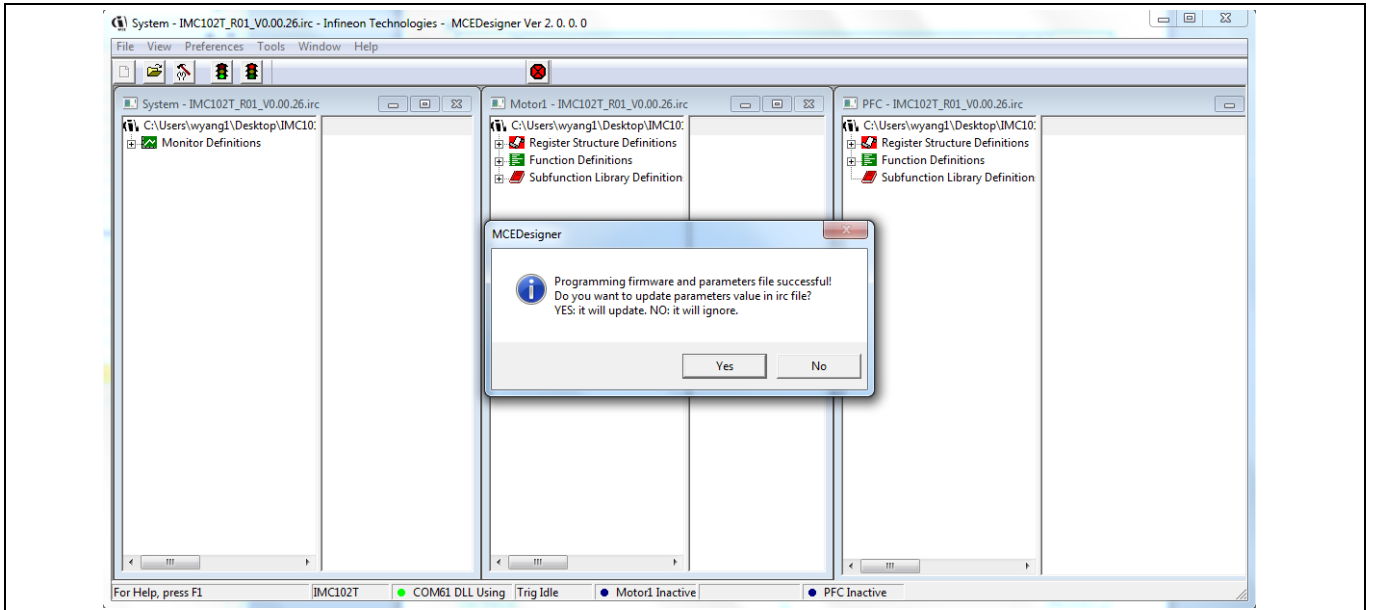

Figure 15 Programming complete

Upon successful programming process, the tool will prompt user to save the system configuration to the .irc file.

4.2 Using iMOTION™ Link with standard ARM® IDEs

4.2.1 PC port configuration

When iMOTION™ Link is used for the first time, the user needs to configure the connection. If there is no connection or the configuration has problem, IDE will prompt warning information. Here using Keil uVision5 for example.

Launch KEIL-MDK and select one project. Open “Options for Target...”, press Debug tap.

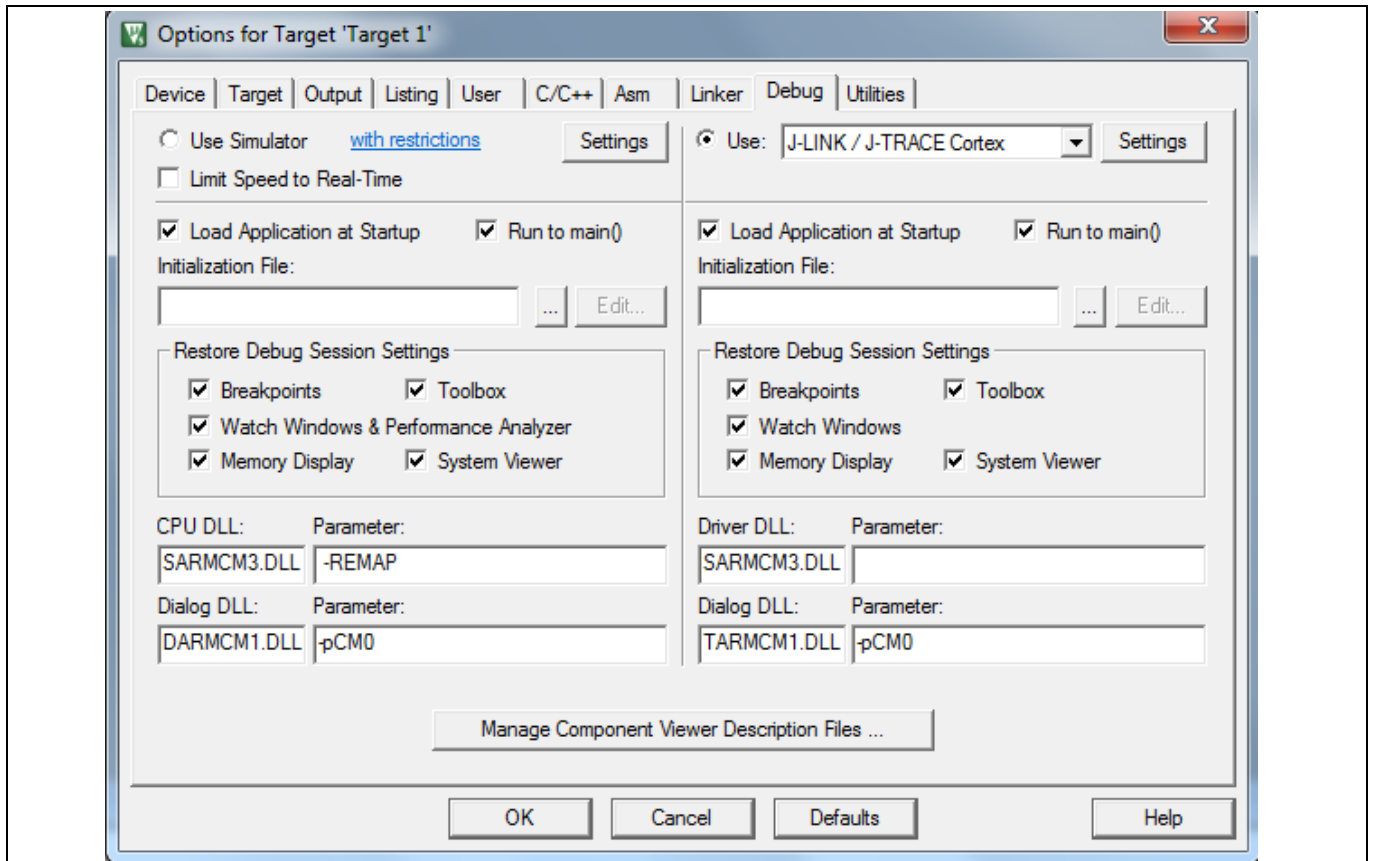

Figure 16 Configuring the Project

Note: If there is no iMOTION™ Link connection to the PC or the configuration is mismatched, the following error messages will appear. Please reconfigure the port settings.

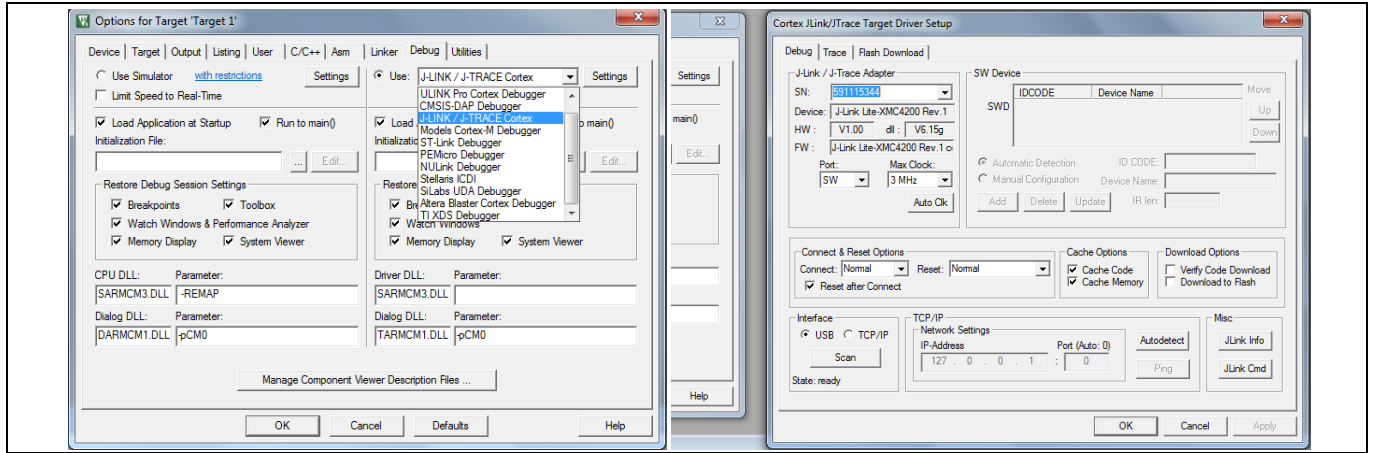

Figure 17 Configuring the J-Link /J-Trace Target Driver Setup

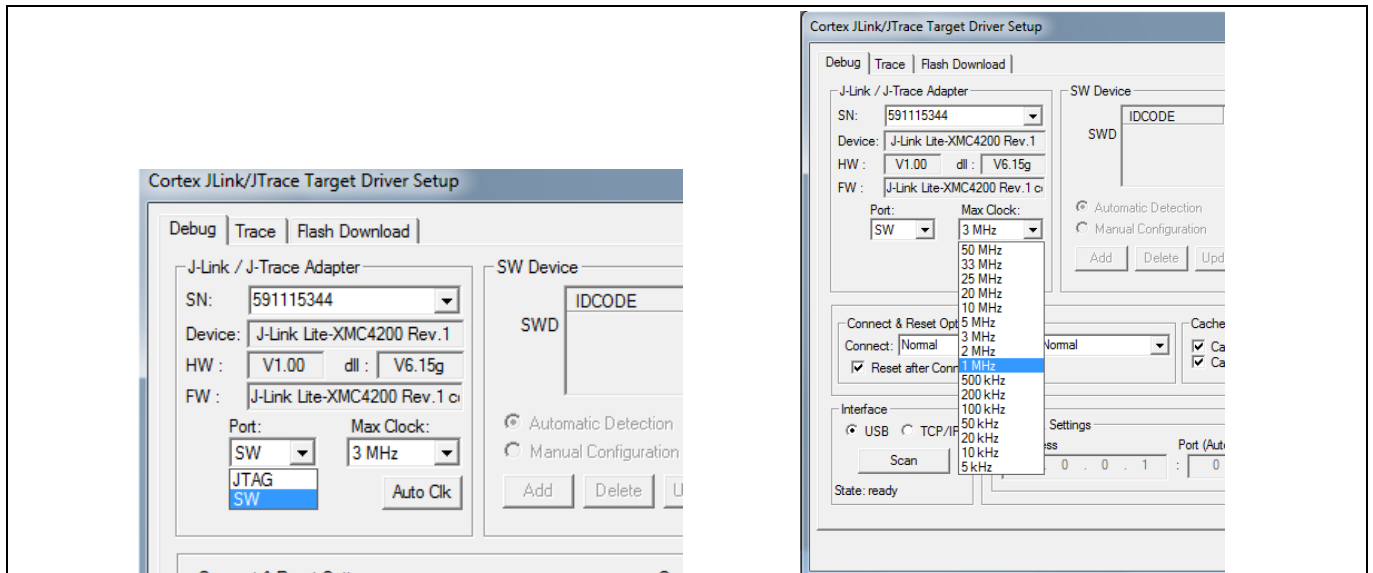

Figure 18 Select desired option.

Note: For now, iMOTION™ device only supports "SW" port option, the Max Clock value is depending on target device environment. If the board noise and outside disturbance are small, the maximum clock can be used.

Revision history

Major changes since the last revision

Version number	Revision date	Revision description
1.0	2018-06-11	First Release
1.1	2020-01-23	Updated schematics on page 8 by removing resistor R1

Trademarks of Infineon Technologies AG

μ HVIC™, μ IPM™, μ PFC™, AU-ConvertIR™, AURIX™, C166™, CanPAK™, CIPOS™, CIPURSE™, CoolDP™, CoolGaN™, COOLiR™, CoolMOS™, CoolSET™, CoolSiC™, DAVE™, DI-POL™, DirectFET™, DrBlade™, EasyPIM™, EconoBRIDGE™, EconoDUAL™, EconoPACK™, EconoPIM™, EiceDRIVER™, eupec™, FCOS™, GaNpowIR™, HEXFET™, HITFET™, HybridPACK™, iMOTION™, IRAM™, ISOFACE™, IsoPACK™, LEDrivr™, LITIX™, MIPAQ™, ModSTACK™, my-d™, NovalithIC™, OPTIGA™, OptiMOS™, ORIGA™, PowIRaudio™, PowIRStage™, PrimePACK™, PrimeSTACK™, PROFET™, PRO-SIL™, RASIC™, REAL3™, SmartLEWIS™, SOLID FLASH™, SPOC™, StrongIRFET™, SupIRBuck™, TEMPFET™, TRENCHSTOP™, TriCore™, UHVIC™, XHP™, XMC™

Trademarks updated November 2015

Other Trademarks

All referenced product or service names and trademarks are the property of their respective owners.

Edition <2020-01-23>

Published by

Infineon Technologies AG

81726 München, Germany

© 2020 Infineon Technologies AG.

All Rights Reserved.

Do you have a question about this document?

Email: erratum@infineon.com

Document reference

IMPORTANT NOTICE

The information given in this document shall in no event be regarded as a guarantee of conditions or characteristics ("Beschaffheitsgarantie").

With respect to any examples, hints or any typical values stated herein and/or any information regarding the application of the product, Infineon Technologies hereby disclaims any and all warranties and liabilities of any kind, including without limitation warranties of non-infringement of intellectual property rights of any third party.

In addition, any information given in this document is subject to customer's compliance with its obligations stated in this document and any applicable legal requirements, norms and standards concerning customer's products and any use of the product of Infineon Technologies in customer's applications.

The data contained in this document is exclusively intended for technically trained staff. It is the responsibility of customer's technical departments to evaluate the suitability of the product for the intended application and the completeness of the product information given in this document with respect to such application.

For further information on the product, technology delivery terms and conditions and prices please contact your nearest Infineon Technologies office (www.infineon.com).

WARNINGS

Due to technical requirements products may contain dangerous substances. For information on the types in question please contact your nearest Infineon Technologies office.

Except as otherwise explicitly approved by Infineon Technologies in a written document signed by authorized representatives of Infineon Technologies, Infineon Technologies' products may not be used in any applications where a failure of the product or any consequences of the use thereof car reasonably be expected to result in personal injury.