



ShenZhen inanbo Electronic Co., LTD.

2011

Website:<http://www.inanbo.com>

SPECIFICATION OF TFT MODULE

FOR INANBO-T28-ILI9325/ILI9328-V11

Remark:



Contents

Contents

Contents.....	1
Mechanical Specification.....	2
Mechanical Drawing.....	2
Interface.....	4
Application Product.....	5
Absolute Maximum Ratings.....	5
Electrical Characteristics.....	5
Optical Characteristics:.....	6
FIG.1 Optical Characteristic Measurement Equipment and Method.....	7
FIG. 3 The definition of Response Time.....	8
FIG. 4 The definition of viewing angle.....	9
Block Diagram:.....	10
Backlight:.....	10
Timing Control:.....	11
Parallel 8080 Timing Charecteristics.....	11
General Precautions.....	12
Safety.....	12
Handling.....	12
Static Electricity.....	12
Storage.....	12
Cleaning.....	12



INANBO

Specification of INANBO-T28-ILI9325-ILI9328-V11

Mechanical Specification

Item	Standard Value	Unit
Display size	2.8	inch
Module Dimension	H/W/D 69.2×50 ×4.2	mm
Active Area	W/H 43.2×57.6	mm
Number of Dots	W/RGB/H 240×3×320	Dot
Pixel size	W/H 0.18×0.18	mm
LCD Type	TFT/ Transmissive / Negative	-
Driving IC	ILI9325/ILI9328(8BIT / 16BIT)	
Approx. Weight	TBD	g
Various color Display	65K 262K	
Backlight Color	White	

Mechanical Drawing

1. 结构尺寸 (MECHANICAL OUTLINE)

单位: mm 未注极限尺寸公差±0.2 (Unit: mm Unmarked Tolerance: ±0.20)
 发光颜色: 白色 / COLOR: White

RoHS

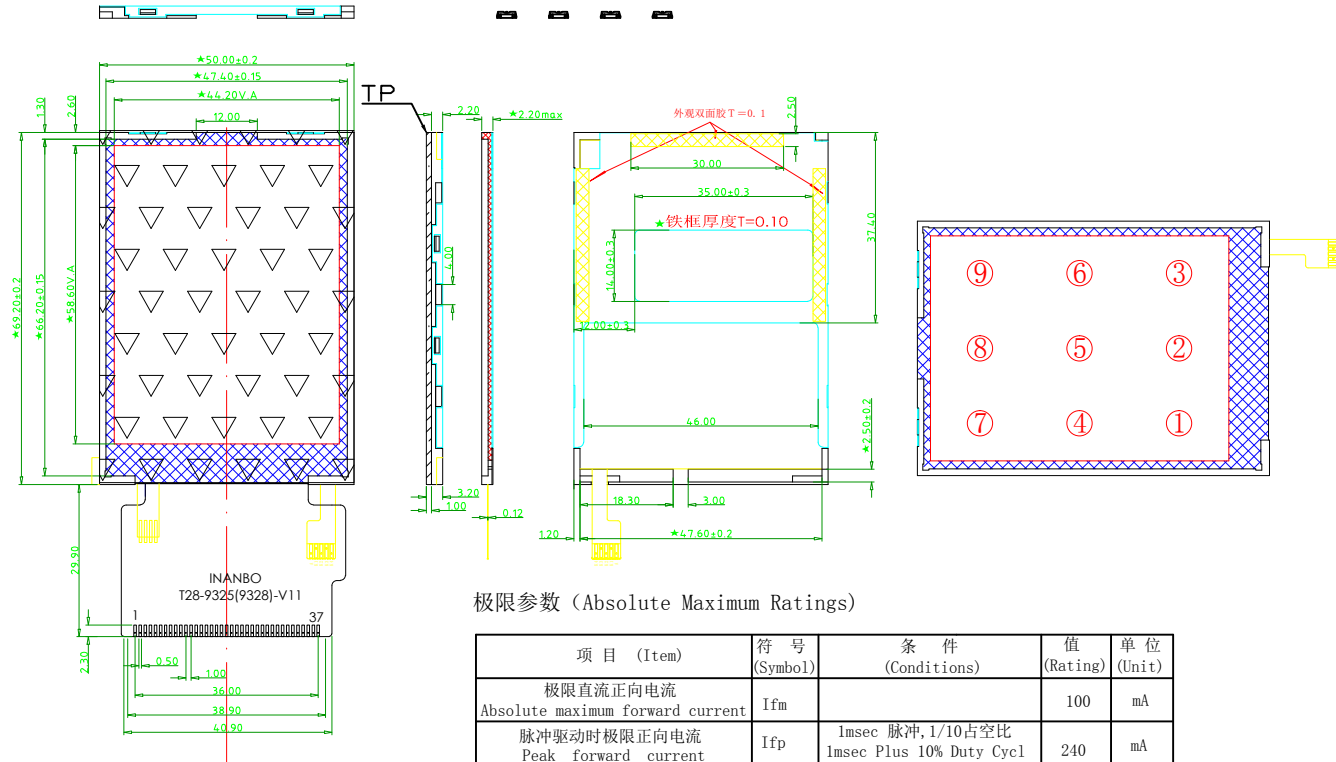

01	DB0
02	DB1
03	DB2
04	DB3
05	GND
06	VCC
07	/CS
08	RS
09	/WR
10	RD
11	IM0
12	X+
13	Y+
14	X-
15	Y-
16	LED-A
17	LED-1
18	LED-2
19	LED-3
20	LED-4
21	IM1
22	DB4
23	DB8
24	DB9
25	DB10
26	DB11
27	DB12
28	DB13
29	DB14
30	DB15
31	REST
32	VCC
33	VCC
34	GND
35	DB5
36	DB6
37	DB7

极限参数 (Absolute Maximum Ratings)

项目 (Item)	符号 (Symbol)	条件 (Conditions)	值 (Rating)	单位 (Unit)
极限直流正向电流 Absolute maximum forward current	Ifm		100	mA
脉冲驱动时极限正向电流 Peak forward current	Ifp	1msec 脉冲, 1/10占空比 1msec Plus 10% Duty Cycl	240	mA
反向电压 Reverse Voltage	Vr		5	V
*极限功耗 Power dissipation	Pd		480	mW
工作温度 Operating Temperature Range	Topr		-20~+70	°C
储存温度 Storage Temperature Range	Tstg		-30~+80	°C

5. 电路图:

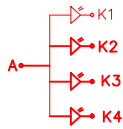

Revision Record

Content

Rev

Dat

Issue

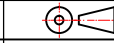

按以下的标准测量:



版本

AO

单位

mm

型号

INANBO-T28-9325(9328)-V11

品名

成品图纸

规格

50*69.2*2.35

客户料号

2.8



深圳市艾蓝电子技术有限公司
<http://www.inanbo.com>

Issue By:

钟文略

Date:

2012-02-30

Check By:

Date:

Approved By:

Date:



Interface

	Symbol	Function
1	DB0-DB3	Data Bus Bit(0-3) Contact to Drive IC Data Bus Bit(0-3)
2	-	-
3	-	-
4	-	-
5	GND	System Ground.(0V)
6	VCC	A Power supply for the internal logic circuit(+2.8V~3.3V)
7	/CS	Chip select signal. Active"L".
8	RS	Command / Display data selection 0:Command, 1:Display Data
9	/WR	I80 system: Serves as a write signal and writes data at the rising edge. M68 system:0:Write 1:Read
10	/RD	I80 System: Serves as a read signal and reads data at the low level. M68 System: 0: Read/Write disable, 1: Read/Write enable
11	IM0	IM0 Data Bus Width LCM DB Pin
		0 16Bit parallel interface DB0-DB7 and DB10-DB17
		1 8Bit parallel interface DB10-DB17
		Unused pin must fixed either VCC2 or GND1 LEVEL
12	X+	Touch Panel Output Pin.(Touch Screen X Coordinate Right)
13	Y+	Touch Panel Output Pin.(Touch Screen Y Coordinate Down)
14	X-	Touch Panel Output Pin.(Touch Screen X Coordinate Left)
15	Y-	Touch Panel Output Pin.(Touch Screen Y Coordinate Up)
16	LEDA	Backlight LED Anode Input Pin (A)
17-20	LEDK1-LEDK4	Backlight LED Anode Input Pin (K1-K4)
18	-	-
19	-	-
20	-	-
21	IM3	0:Format for I80 series MPU, 1: Format For M68 series MPU
22	DB4	Data Bus Bit(04) Contact to Drive IC Data Bus Bit(4)
23	DB10	Data Bus Bit(10) Contact to Drive IC Data Bus Bit(8)
24	DB11	Data Bus Bit(11) Contact to Drive IC Data Bus Bit(9)
25	DB12	Data Bus Bit(12) Contact to Drive IC Data Bus Bit (10)
26	DB13	Data Bus Bit(13) Contact to Drive IC Data Bus Bit(11)
27	DB14	Data Bus Bit(14) Contact to Drive IC Data Bus Bit(12)
28	DB15	Data Bus Bit(15) Contact to Drive IC Data Bus Bit(13)
29	DB16	Data Bus Bit(16) Contact to Drive IC Data Bus Bit(14)
30	DB17	Data Bus Bit(17) Contact to Drive IC Data Bus Bit(15)
31	/RESET	Reset input pin for TFT LCD. When /RESET is "L", initialization is executed.
32	VCI	A power supply for step-up circuit and power supply circuit.(+2.8V)
33	VCC2	Power supply for I/O circuit.(+2.8V~3.3V)
34	GND	System Ground.(0V)



INANBO

35-37	DB5-DB7	Data Bus Bit(5-7) Contact to Drive IC Data Bus Bit(5-7)
36	-	-
37	-	-

Application Product

1. Embedded Electronics Product
2. Advertising Display Product
3. Mobile phone
4. MP4,PDA
5. AV Product

Absolute Maximum Ratings

Item	Unit	Symbol	Min.	Typ.	Max.	Remark
Supply Voltage for logic	V	VCC	-0.3	-	+4.6	-
Input Voltage	V	Vin	-0.5	-	VDD+0.5	-
Operating Temperature	°C	Top	-20	-	+60	-
Storage Temperature	°C	Tst	-30	-	+70	-

Electrical Characteristics

Item	Symbol	Condition	Min.	Typ.	Max.	Unit
Supply Voltage for logic	Vdd	Ta=25°C	2.5	2.8	3.3	V
Power input voltage	Vci	-	2.5	-	3.3	V
High-level input voltage	VIHC	VDD=2.8V	0.8VDD	-	VDD	V
Low-level input voltage	VILC	VDD=2.8V	0	-	0.2VDD	V
TFT gate on voltage	VGH	VDD=2.8V	-	15	-	V
TFT gate off voltage	VGL	VDD=2.8V	-	-10	-	V
TFT common electrode voltage	VcomH	-	2.5	-	4	V
	VcomL	-	-1.5	-	0	V
Consumption Current of VDD	IDD	Electric VR Value=TBD	-	2.5	4	mA
Power Supply Current	IDD	VDD=2.8V	-	-	7	mA



For VDD

Optical Characteristics:

Item	Symbol	Condition	Min.	Typ.	Max.	Unit
View Angle(V)	θ	Center	-10	-	35	Deg.
View Angle(H)	Φ	CR>10	-45	-	45	Deg.
Contrast Ratio	CR		150	300	-	-
Response Time(Rise)	Tr	Ta=25°C	-	10	-	ms
Response Time(Fall)	Tf		-	15	-	ms

Color of CIE Coordinate

Item	Symbol	Condition	Min.	Typ.	Max.	Note	
Color of CIE Coordinate	Red	X	0.635	0.655	0.675	Color of CIE Coordinate	
		Y	0.309	0.329	0.349		
	Green	X	$\theta = 0^\circ\text{C}$	0.292	0.312		0.332
		Y	$\Phi = 0^\circ\text{C}$	0.555	0.575		0.595
	Blue	X	Ta=25°C	0.114	0.134		0.154
		Y		0.115	0.135		0.155-
	White	X		0.290	0.310		0.330
		Y		0.321	0.341		0.361

Notes :

- Contrast Ratio(CR) is defined mathematically as :

Contrast Ratio = $\frac{\text{Surface Luminance with all white pixels}}{\text{Surface Luminance with all black pixels}}$

- Surface luminance is the center point across the LCD surface 500mm from the surface with all pixels displaying white. For more information see FIG 1.
- Response time is the time required for the display to transition from to black(Rise Time, TrR) and from black to white(Decay Time, TrD). For additional information see FIG 3.



- Viewing angle is the angle at which the contrast ratio is greater than 10. The angles are determined for the horizontal or x axis and the vertical or y axis with respect to the z axis which is normal to the LCD surface. For more information see FIG 5.
- Optimum contrast is obtained by adjusting the LCD Threshold voltage(V_{th} & V_{sat})
FIG. 1 Optical

FIG.1 Optical Characteristic Measurement Equipment and Method

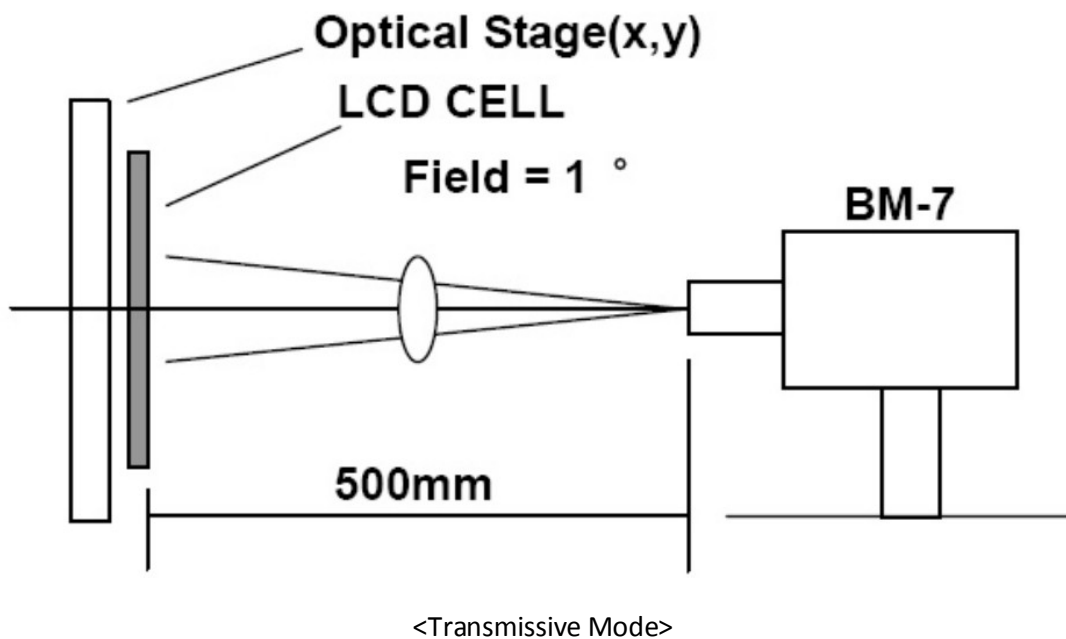

FIG.2 The definition of V_{th} and V_{sat}

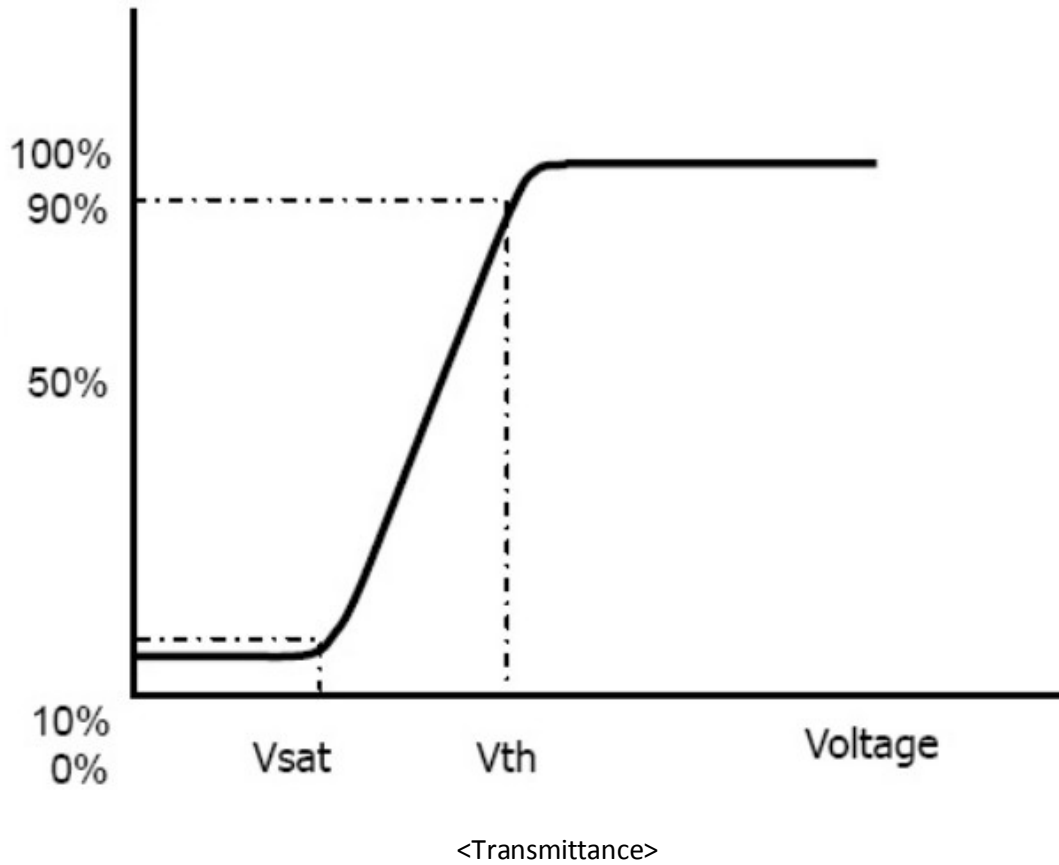
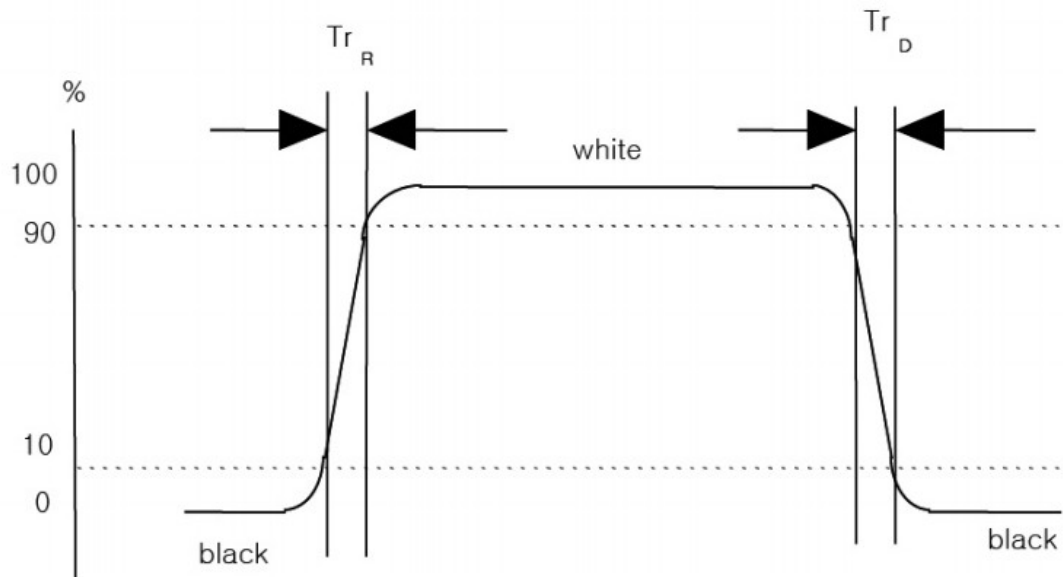

FIG. 3 The definition of Response Time

The response time is defined as the following figure and shall be measured by switching the input signal for “black” and “white”.



<Optical Response>

FIG. 4 The definition of viewing angle

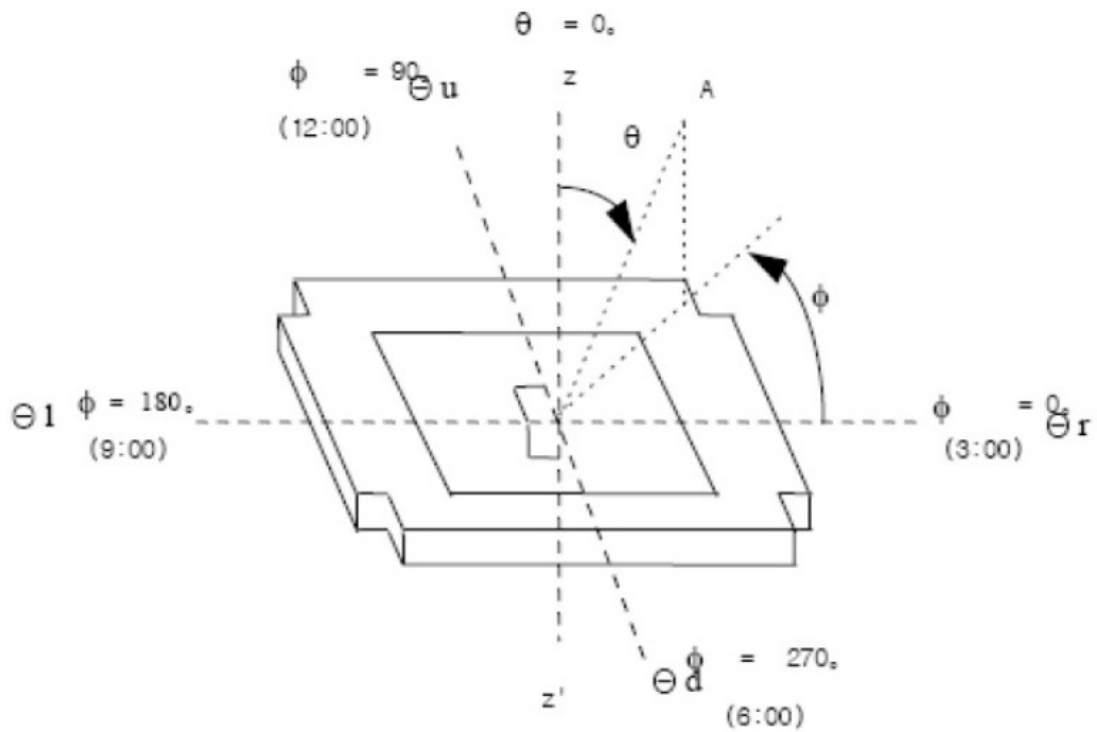

<dimension of viewing angel range>



Block Diagram:

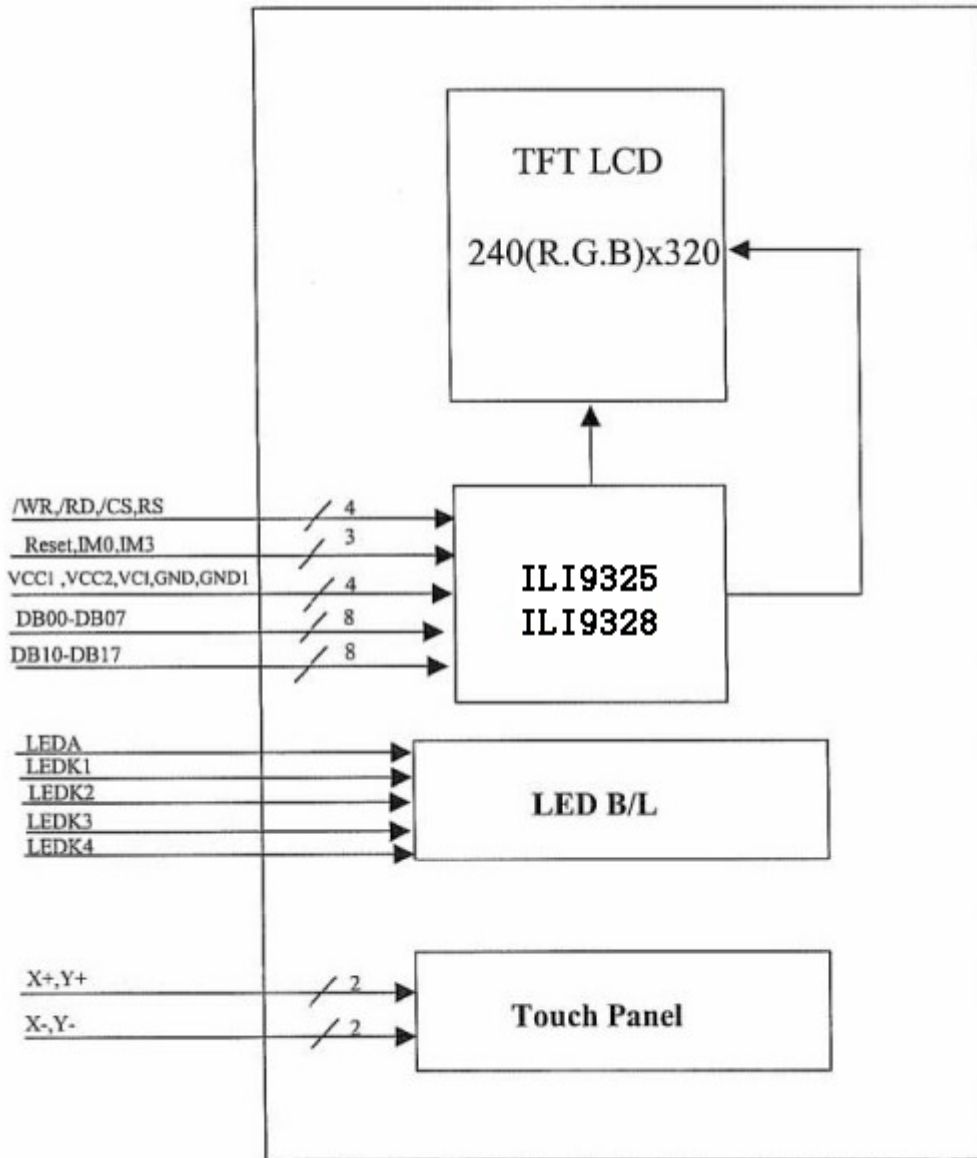

Backlight:

Item	Symbol	Conditions	Min.	Typ.	Max.	Unit
Forward Voltage	VF	Ta=25°C	-	3.5	-	V
Forward Current	IF	Ta=25°C	-	80	-	mA
LED Chips	-	-	-	4	-	PCS



Timing Control:

Parallel 8080 Timing Charecteristics

Normal Write Mod(IO VCC= 1.65-3.3V, VCC=2.4-3.3V)

Item		Symbol	Unit	Min.	Typ.	Max.	Condition
Bus cycle time	Write	Tcyw	ns	100	-	-	-
	Read	Tcyr	ns	300	-	-	-
Write low-level pulse width		PWlw	Ns	50	-	500	-
Write high-level pulse width		PWhw	Ns	50	-	-	-
Read low-level pulse width		PWlr	Ns	150	-	-	-
Read high-level pulse width		PWhr	ns	150	-	-	-
Write /Read rise / fall time		Twrr/Twrf	ns	-	-	25	
Setup time	Write(RS to nCS, E/nWR)	Tas	ns	10	-	-	-
	Read (RS to nCS,RW/nRD)			5	-	-	-
Address hold time		Tah	Ns	5	-	-	-
Write data set up time		Tdsw	Ns	10	-	-	-
Write data hold time		Th	Ns	15	-	-	-
Read data delay time		TDDR	Ns	-	-	100	-
Read data hold time		Tdhr	Ns	5	-	-	-

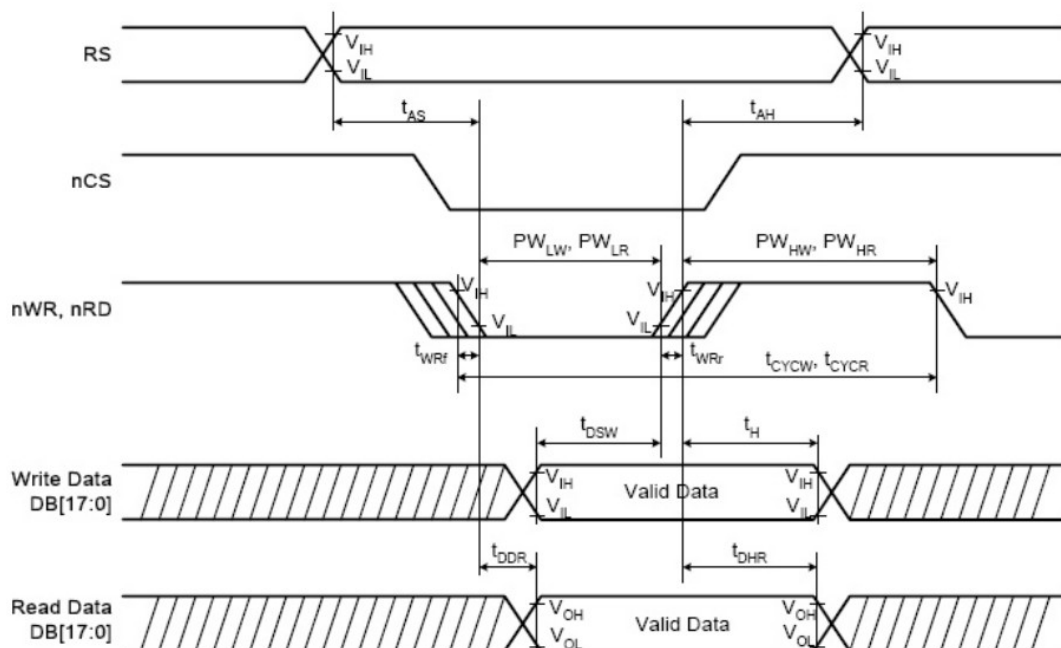



General Precautions

Safety

Liquid crystal is poisonous. Do not put it in your mouth. If liquid crystal touches your skin or clothes, wash it off immediately by using soap and water.

Handling

- 1.The LCD panel is plate glass. Do not subject the panel to mechanical shock or to excessive force on its surface.
- 2.The polarizer attached to the display is easily damaged. Please handle it carefully to avoid scratch or other damages.
- 3.To avoid contamination on the display surface, do not touch the module surface with bare hands.
- 4.Keep a space so that the LCD panels do not touch other components.
- 5.Put cover board such as acrylic board on the surface of LCD panel to protect panel from damages.
- 6.Transparent electrodes may be disconnected if you use the LCD panel under environmental conditions where the condensation of dew occurs.
- 7.Do not leave module in direct sunlight to avoid malfunction of the ICs.

Static Electricity

- 1.Be sure to ground module before turning on power or operating module.
- 2.Do not apply voltage which exceeds the absolute maximum rating value.

Storage

- 1.Store the module in a dark room where must keep at 25 }10 and 65%RH or less.
- 2.Do not store the module in surroundings containing organic solvent or corrosive gas.
- 3.Store the module in an anti-electrostatic container or bag.

Cleaning

1. Do not wipe the polarizer with dry cloth. It might cause scratch.
- 2.Only use a soft sloth with IPA to wipe the polarizer, other chemicals might permanent damage to the polarizer.



INANBO

DOC NO:INANBO-T28-ILI9325-ILI9328-V11

REV:V11

Date:2011-11-14

Page: 13 of 13

END