

HRB1 Relay

1.COIL DATA

1-1.Nominal Voltage	3,5,6,9,12,24VDC
1-2.Coil Resistance	Refer to Coil Data Chart
1-3.Operate Voltage	Refer to Coil Data Chart
1-4.Release Voltage	Refer to Coil Data Chart
1-5.Nominal Power	150mW、175mW(24VDC)

2.CONTACT DATA

2-1.Contact Form	C-1 Form C
2-2.Contact Material	AuAg
2-3.Contact Rating(Resistive)	1A 120VAC/30VDC
2-4.Max.Switching Voltage	125VAC/30VDC
2-5.Max.Switching Current	1A
2-6.Max.Switching Poer	125VA,30W
2-7.Max.Switching Load	5VDC,10mA
2-8.Contact Resistance(Initial)	Max.50m Ω (6VDC 1A)
2-9.Life	
Electrical	100,000 operations
Mechanical	5,000,000 operations

3.GENERAL DATA

3-1.Insulation Resistance	Min.1,000M Ω . 500VDC
3-2.Dielectric Strength	
	500VAC,1min between open contacts
	1,000VAC,1min between coil and contacts
3-3.Surge Strength	1,5000VAC
3-4.Operate Time	Max.5ms
3-5.Release Time	Max.5ms
3-6.Operate Temperature	-40 \sim +70 $^{\circ}$ C(no frost)
3-7.Shock Resistance	
Endurance	1,000m/s ²
Misoperation	100m/s ²
3-8.Vibration Resistance	
Endurance	10 \sim 55Hz,1.5mm double amplitude
Misoperation	10 \sim 55Hz,1.5mm double amplitude
3-9.Humidity	35% \sim 95%RH,+40 $^{\circ}$ C
3-10.Weight	Approximately 2.2g
3-11.Safety	UL/cUL NO.E164730 CSA NO.1369391(LR109368)

4.ORDER CODE

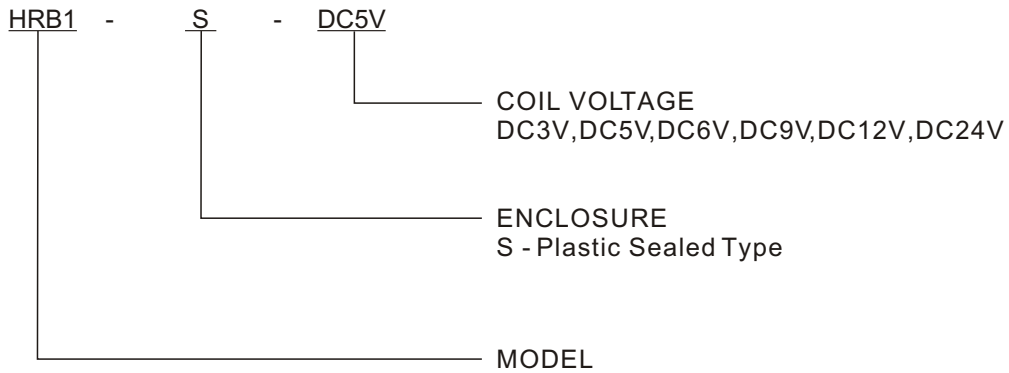

5.COIL DATA CHART

20°C

Model	Nominal Voltage VDC	Coil Resistance Ω +/-10%	Operate Voltage \leq VDC	Release Voltage \geq VDC	Coil Power mW
HRB1-(S)-DC3V	3	60	2.1	0.30	150
HRB1-(S)-DC5V	5	167	3.5	0.50	
HRB1-(S)-DC6V	6	240	4.2	0.60	
HRB1-(S)-DC9V	9	540	6.3	0.90	
HRB1-(S)-DC12V	12	960	8.4	1.20	
HRB1-(S)-DC24V	24	3291	16.8	2.40	175

6.DIMENSIONS (mm)

Dimensions

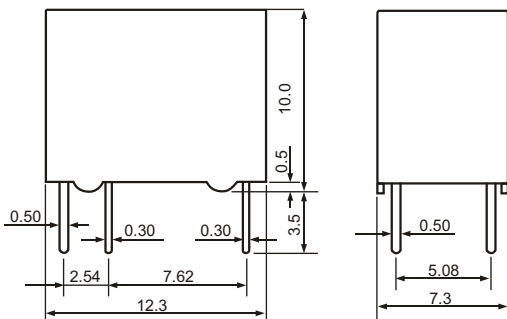

Wiring Diagrams

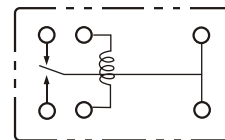

Mounting Hole Layout

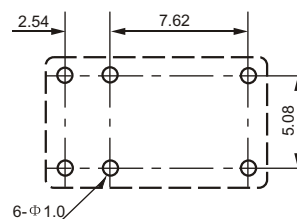

7.HRB1 CHARACTERISTIC CHART DATA

Timing

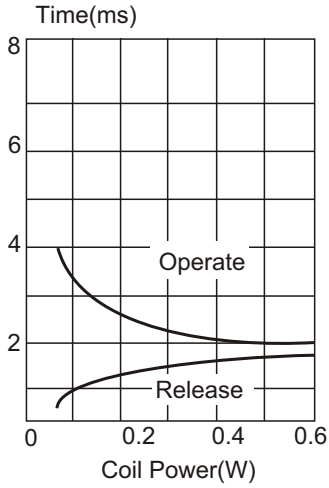

Coil Temperature Rise

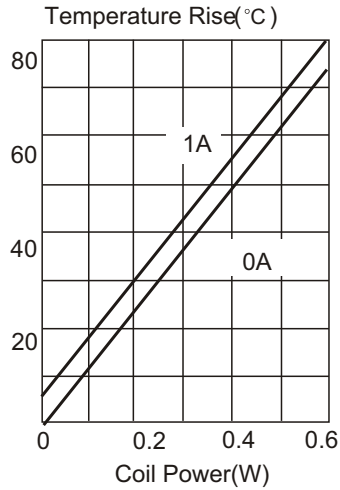

Operating Range

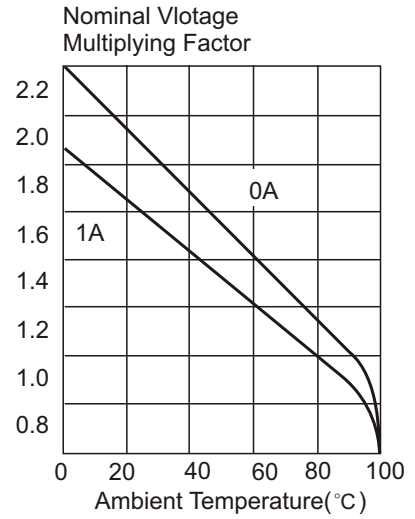

Max. Switching Power

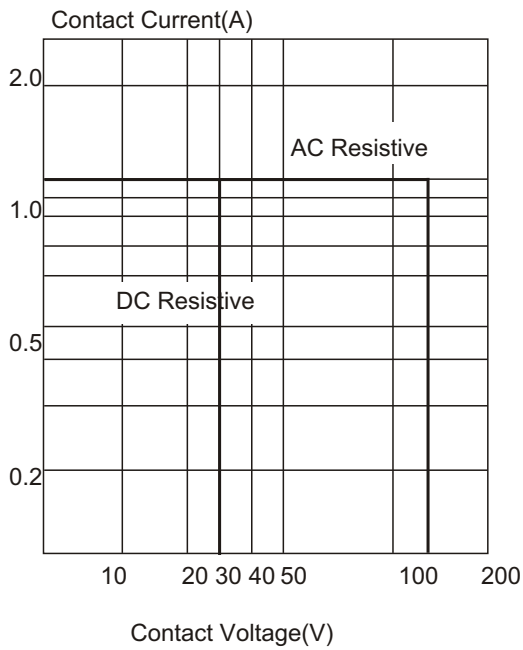

Life Curves

