

### FEATURES

- **2 CHANNEL TYPE:**  
OCMOS FET + PHOTOCOUPLER
- **DESIGNED FOR AC/DC SWITCHING LINE CHANGER**
- **SMALL PACKAGE:**  
8-PIN SOP
- **ISOLATION VOLTAGE:**  
BV: 1500 Vr.m.s. MIN
- **LOW OFFSET VOLTAGE**
- **LOW LED OPERATING CURRENT:**  
IF = 2 mA
- **AVAILABLE IN TAPE AND REEL**

### DESCRIPTION

PS7241-AT1 and PS7241-AT5 are solid state relays containing a GaAs LED on the emitting side (input side) and MOSFETs (+ Phototransistor) on the output side. They are suitable for analog signal control because of their low offset and high linearity.

### APPLICATIONS

- EXCHANGE EQUIPMENT
- MEASUREMENT EQUIPMENT
- FA/OA EQUIPMENT

### ELECTRICAL CHARACTERISTICS (TA = 25°C)

		PART NUMBER				PS7241-AT1, PS7241-AT5		
		SYMBOLS	PARAMETERS	CONDITIONS	UNITS	MIN	TYP	MAX
OCMOS FET	Diode	VF	Forward Voltage	IF = 5 mA	V		1.2	1.4
		IR	Reverse Current	VR = 5 V	μA			5.0
	MOSFET	ILOFF	Off-state Leakage Current	VD = 400 V	μA		0.03	1.0
		Cout	Output Capacitance	VD = 0 V, f = 1 MHz	pF		65	
	Coupler	IFon	LED On-state Current	IL = 120 mA	mA			2.0
		RON1	On-state Resistance	IF = 10 mA, IL = 10 mA	Ω		20	30
		RON2		IF = 10 mA, IL = 120 mA, t ≤ 10 ms	Ω			25
		ton	Turn-on Time	IF = 10 mA, Vo = 5 V, PW ≥ 10 ms	ms		0.3	1.0
		toff	Turn-off Time		ms		0.04	0.2
		RI-O	Isolation Resistance	V <sub>I-O</sub> = 1.0 kV	Ω	10 <sup>9</sup>		
CI-O	Isolation Capacitance	V = 0 V, f = 1 MHz	pF		1.1			
Photocoupler	Diode	VF	Forward Voltage	IF = 10 mA	V		1.2	1.4
		IR	Reverse Current <sup>1</sup>	VR = 5 V	μA			5.0
	Transistor	ICEO	Collector to Emitter Dark Current	VCE = 40 V, IF = 0 mA	nA			100
		BVCEO	Collector to Emitter Breakdown Voltage	Ic = 1 mA	V	40		
	Coupler	BVECO	Emitter to Collector Breakdown Voltage	IE = 100 μA	V	6		
		CTR	Current Transfer Ratio	IF = 5 mA, VCE = 5 V	%	50		400
		VCE(sat)	Collector Saturation Voltage	IF = 10 mA, Ic = 2 mA	V			0.3
		RI-O	Isolation Resistance	V <sub>in-out</sub> = 1.0 kVcc	Ω	10 <sup>11</sup>		
		CI-O	Isolation Capacitance	V = 0 V, f = 1 MHz	pF		0.4	
tR	Rise Time	Vcc = 5 V, Ic = 2 mA	μs		3.0			
tF	Fall Time	RL = 100 Ω	μs		5.0			

Note:

1. PS7241-AT1 only.

**ABSOLUTE MAXIMUM RATINGS<sup>1</sup>** (T<sub>A</sub> = 25°C)

	SYMBOLS	PARAMETERS	UNITS	RATINGS
OCMOS	Diode			
	I <sub>F</sub>	Forward Current (DC)	mA	50
	V <sub>R</sub>	Reverse Voltage	V	5.0
	P <sub>D</sub>	Power Dissipation	mW/ch	50
	I <sub>FP</sub>	Peak Forward Current <sup>2</sup>	A	1.0
	MOSFET			
	V <sub>L</sub>	Break Down Voltage	V	400
	I <sub>L</sub>	Continuous Load Current	mA	120
	I <sub>LP</sub>	Pulse Load Current <sup>3</sup> (AC/DC Connection)	mA	250
	P <sub>D</sub>	Power Dissipation	mW	430
Photocoupler	Diode			
	I <sub>F</sub>	Forward Current	mA	50
	V <sub>R</sub>	Reverse Voltage <sup>4</sup>	V	5.0
	P <sub>D</sub>	Power Dissipation	mW/ch	50
	I <sub>FP</sub>	Peak Forward Current <sup>2</sup>	A	1.0
	Transistor			
	V <sub>CEO</sub>	Collector to Emitter Voltage	V	40
	V <sub>ECO</sub>	Emitter to Collector Voltage	V	6.0
	I <sub>C</sub>	Collector Current	mA	80
	P <sub>C</sub>	Power Dissipation	mW	100
	BV	Isolation Voltage <sup>5</sup>	V <sub>r.m.s.</sub>	1500
	P <sub>T</sub>	Total Power Dissipation	mW	630
	T <sub>A</sub>	Operating Ambient Temp.	°C	-40 to 80
	T <sub>STG</sub>	Storage Temperature	°C	-40 to 100

**RECOMMENDED OPERATING CONDITIONS** (T<sub>A</sub> = 25°C)

SYMBOLS	PARAMETERS	UNITS	MIN	TYP	MAX
OCMOS FET					
I <sub>F</sub>	LED Operating Current	mA	2	10	20
V <sub>F</sub>	LED Off Voltage	V	0		0.5

**ORDERING INFORMATION**

PART NUMBER	PACKAGE	PACKING STYLE
PS7241-AT1	8-pin SOP	Magazine case 45 pcs
PS7241-AT1-F3		Embossed Tape 1500 pcs/reel
PS7241-AT1-F4		
PS7241-AT5	8-pin SOP	Magazine case 45 pcs
PS7241-AT5-F3		Embossed Tape 1500 pcs/reel
PS7241-AT5-F4		

Notes:

1. Operation in excess of any one of these parameters may result in permanent damage.
2. PW = 100 μs, Duty Cycle = 1%.
3. PW = 100 ms, 1 shot.
4. PS7241-AT1 only.
5. AC voltage for 1 minute at T<sub>A</sub> = 25 °C, RH = 60 % between input and output.

**OUTLINE DIMENSIONS** (Units in mm)

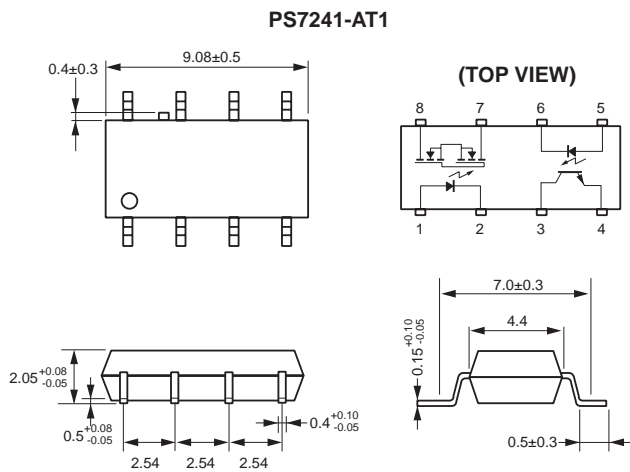

- 1 LED Anode
- 2 LED Cathode
- 3 Tr Collector
- 4 Tr Emitter
- 5 LED Anode
- 6 LED Cathode
- 7 MOSFET
- 8 MOSFET

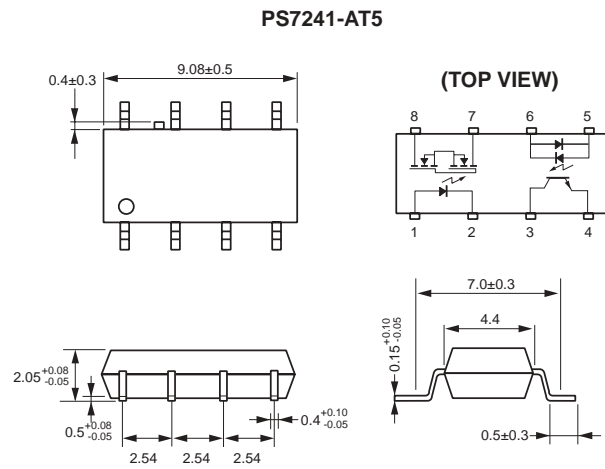

- 1 LED Anode
- 2 LED Cathode
- 3 Tr Collector
- 4 Tr Emitter
- 5 LED Anode/Cathode
- 6 LED Cathode/Anode
- 7 MOSFET
- 8 MOSFET

OCMOS TYPICAL PERFORMANCE CURVES (TA = 25°C)

MAXIMUM FORWARD CURRENT (DC)  
vs. AMBIENT TEMPERATURE

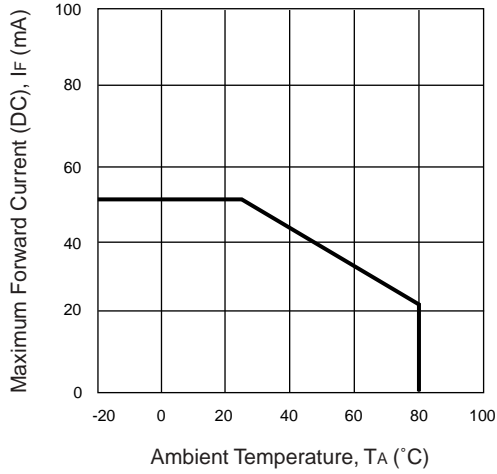

MAXIMUM LOAD CURRENT  
vs. AMBIENT TEMPERATURE

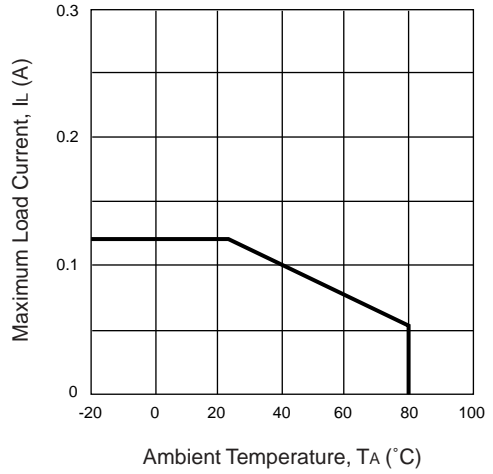

FORWARD VOLTAGE vs.  
AMBIENT TEMPERATURE

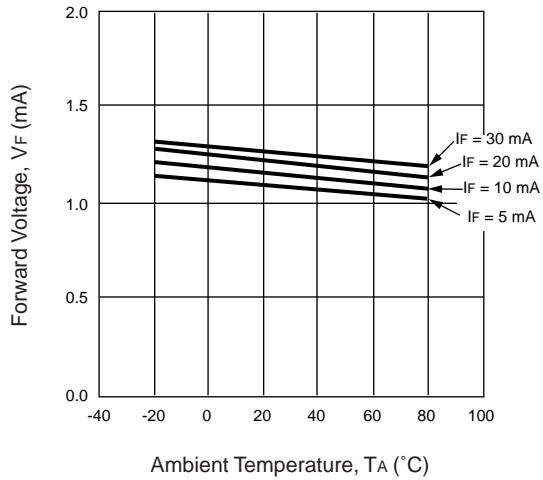

OUTPUT CAPACITANCE  
vs. SUPPLY VOLTAGE

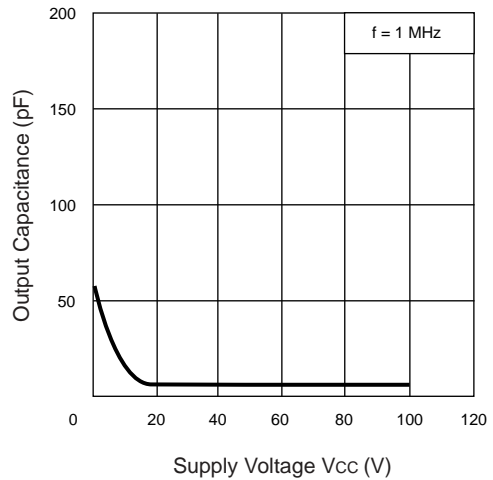

OFF-STATE LEAKAGE CURRENT  
vs. SUPPLY VOLTAGE

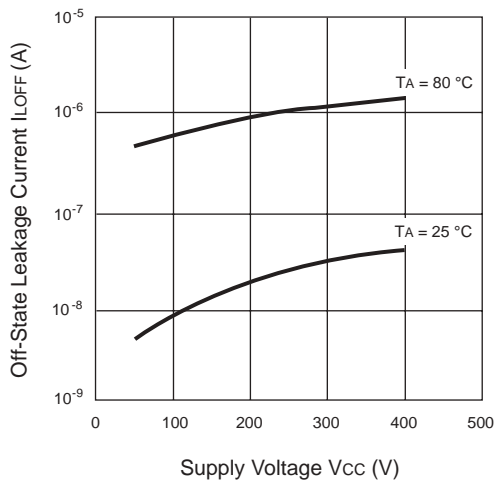

LOAD CURRENT vs.  
LOAD VOLTAGE

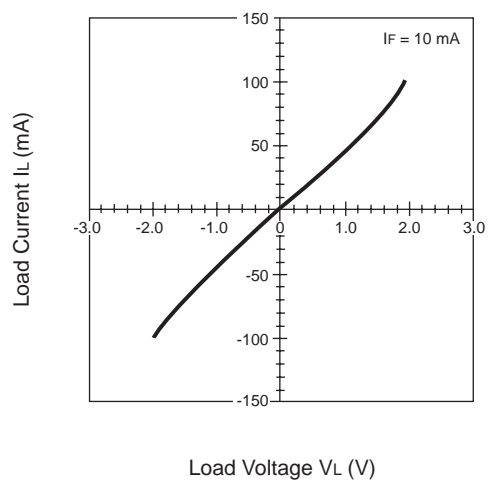

OCMOS TYPICAL PERFORMANCE CURVES (TA = 25°C)

**NORMALIZED ON-STATE RESISTANCE vs. AMBIENT TEMPERATURE**

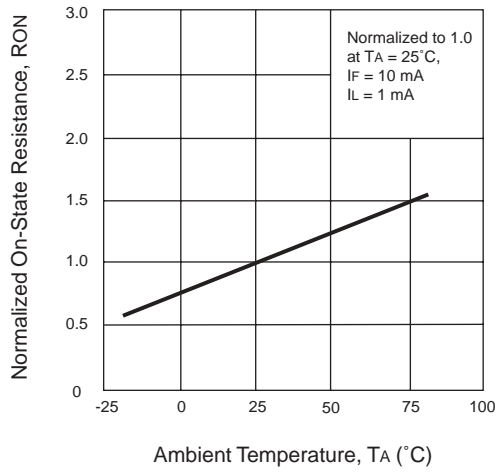

**ON-STATE RESISTANCE DISTRIBUTION**

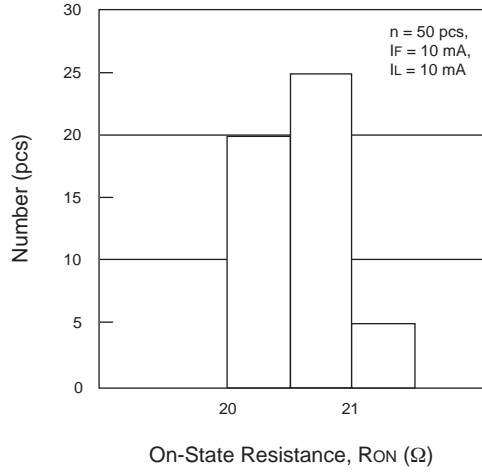

**TURN-ON TIME vs. FORWARD CURRENT**

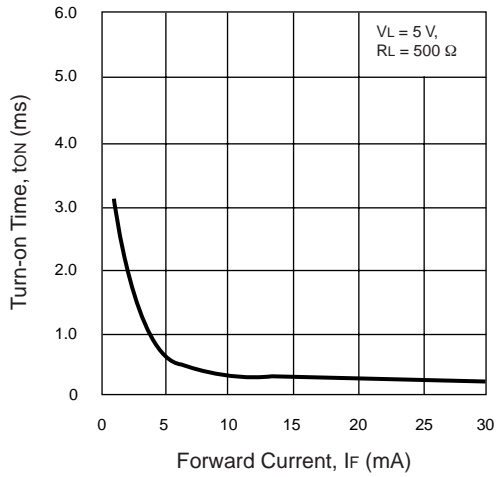

**TURN-OFF TIME vs. FORWARD CURRENT**

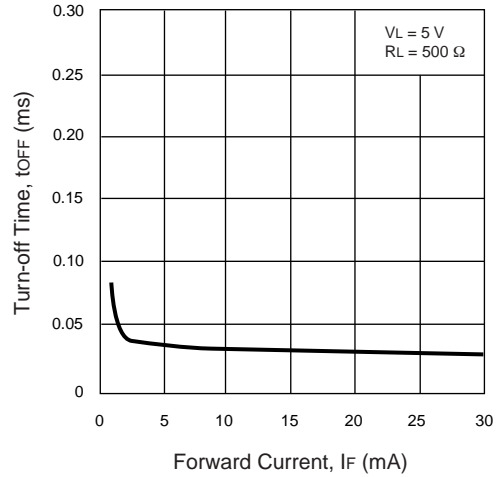

**TURN-ON TIME DISTRIBUTION**

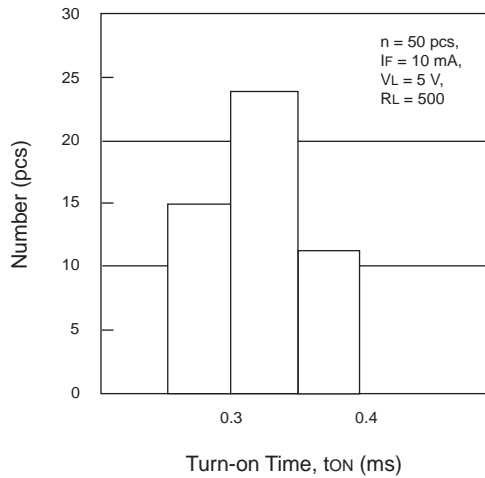

**TURN-OFF TIME DISTRIBUTION**

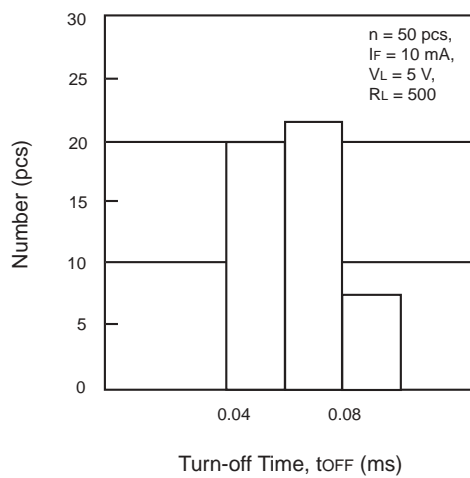

**OCMOS TYPICAL PERFORMANCE CURVES** (TA = 25°C)

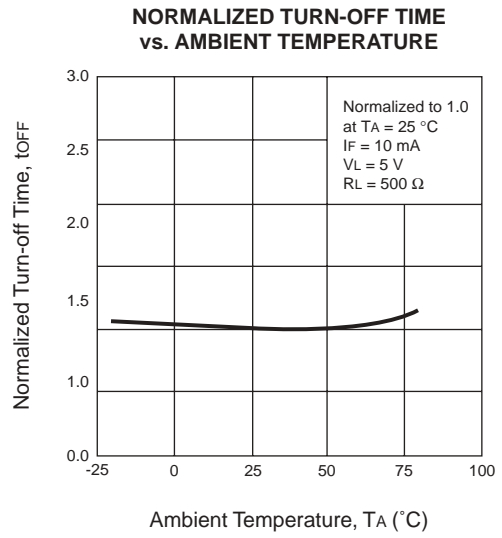
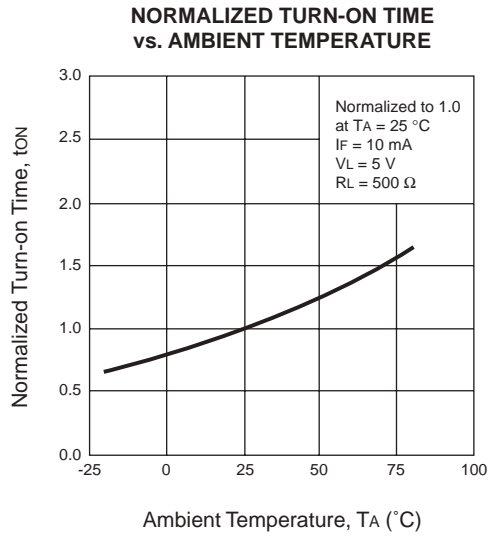

**PHOTOCOUPLER TYPICAL PERFORMANCE CURVES** (TA = 25°C)

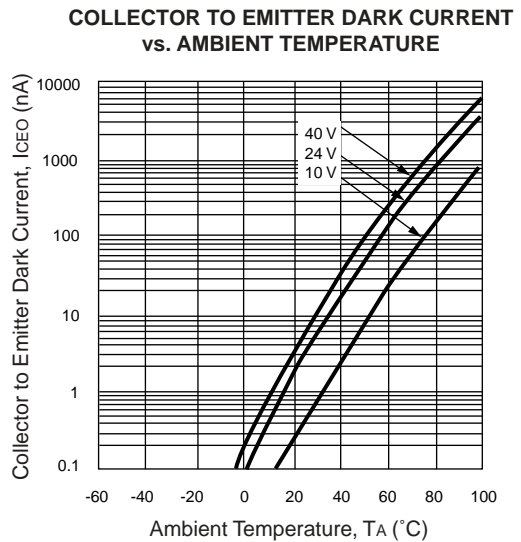
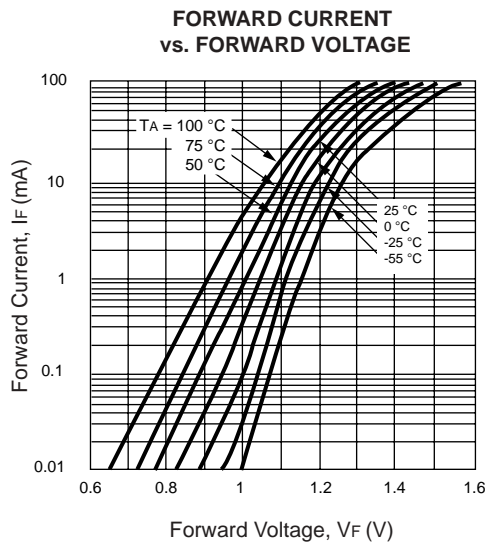
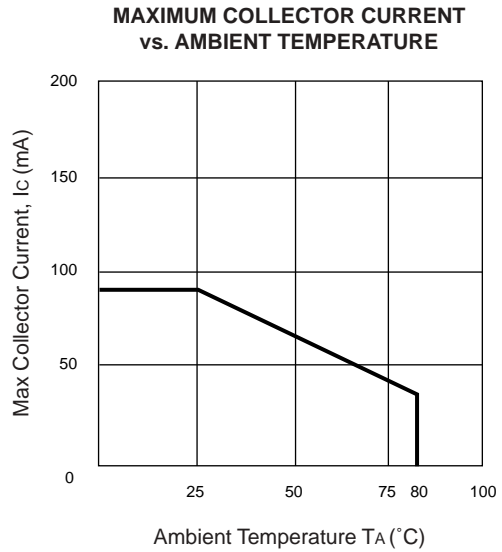
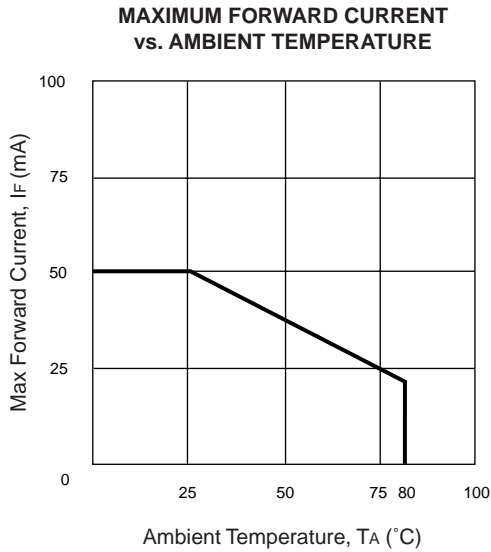

PHOTOCOUPLER TYPICAL PERFORMANCE CURVES (TA = 25°C)

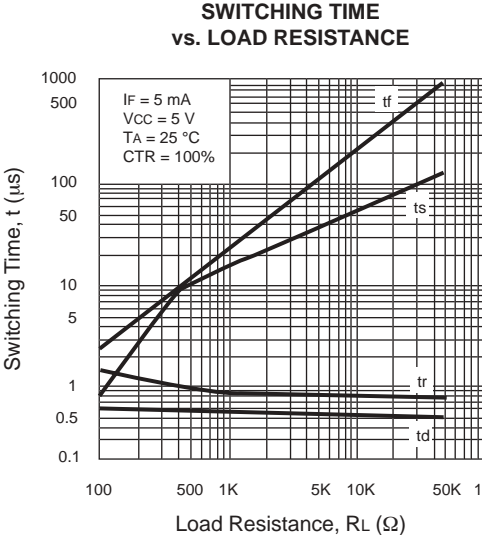
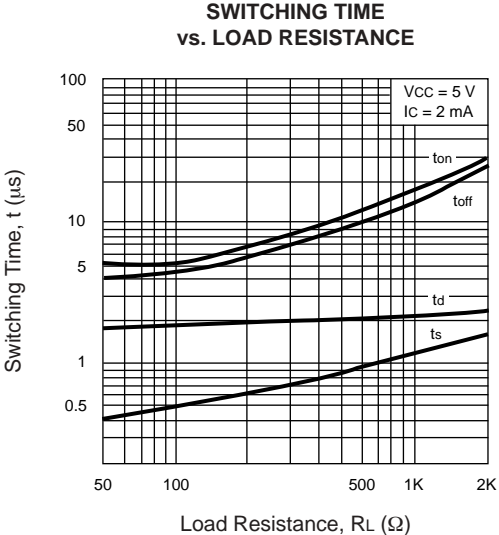
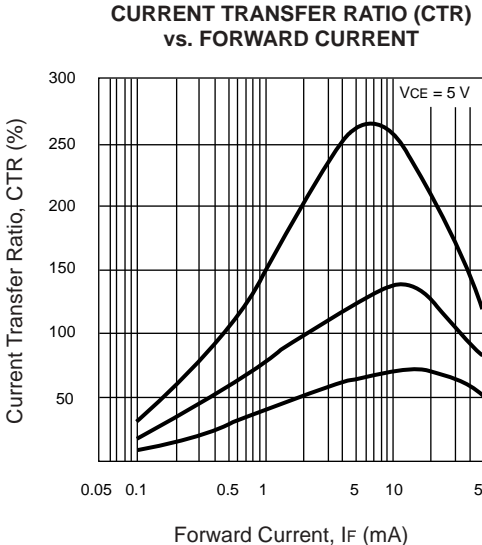
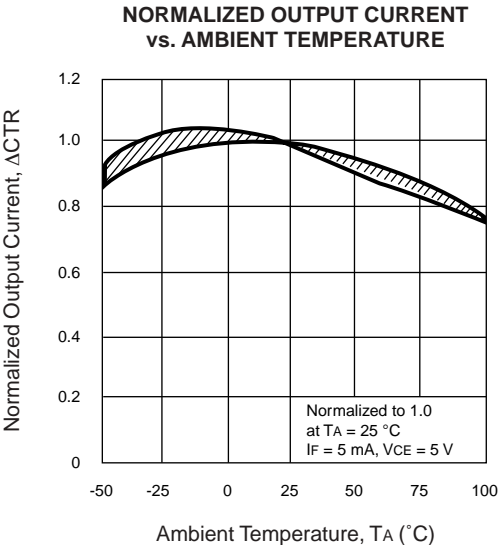
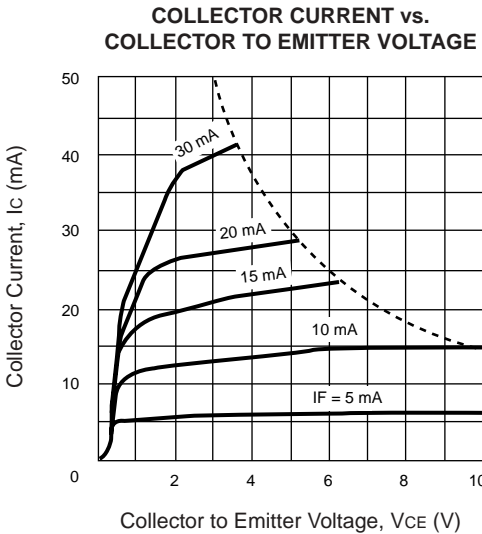
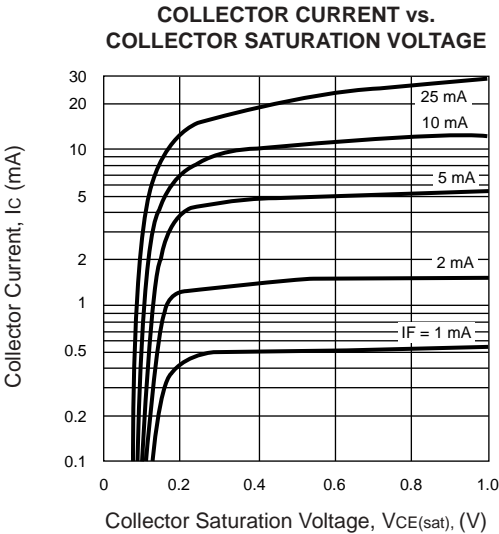

**TAPING SPECIFICATIONS** (Units in mm)

**OUTLINE AND DIMENSIONS (TAPE)**

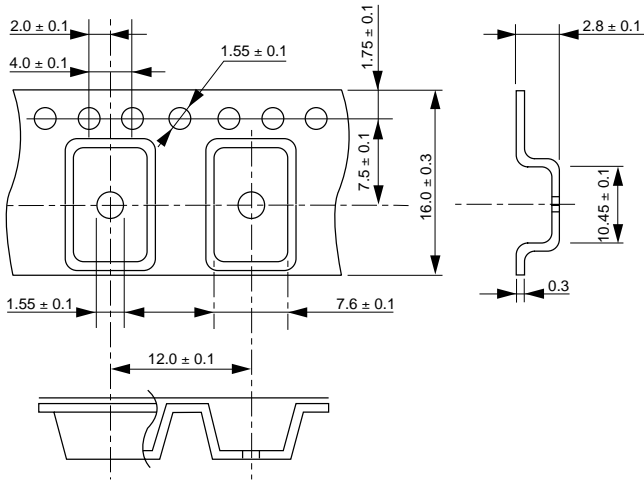

**OUTLINE AND DIMENSIONS (REEL)**

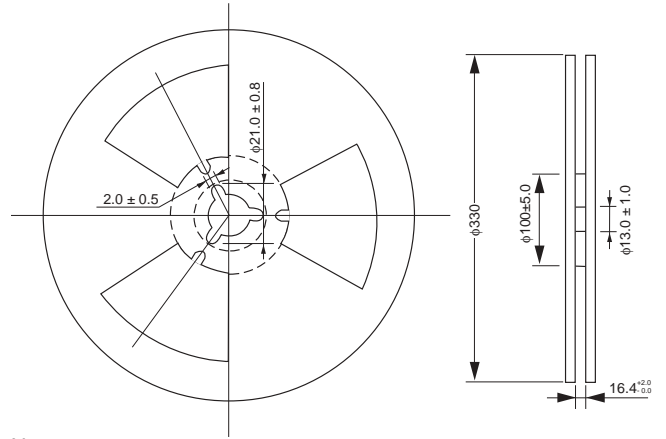

Notes:  
1. Packaging : 1500 pcs/reel

**TAPING DIRECTION**

PS7241-AT1-F3  
PS7241-AT5-F3

PS7241-AT1-F4  
PS7241-AT5-F4

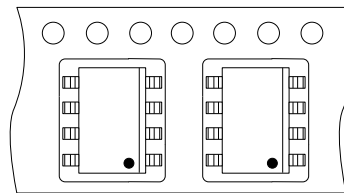
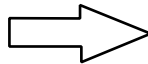
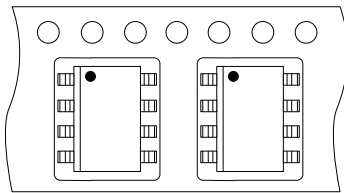

## RECOMMENDED SOLDERING CONDITIONS

### (1) Infrared reflow soldering

- Peak reflow temperature 235 °C or below (package surface temperature)
- Time of temperature higher than 210 °C 30 seconds or less
- Number of reflows Two
- Flux Rosin flux containing small amount of chlorine  
(The flux with a maximum chlorine content of 0.2 Wt % is recommended.)

Recommended Temperature Profile of Infrared Reflow

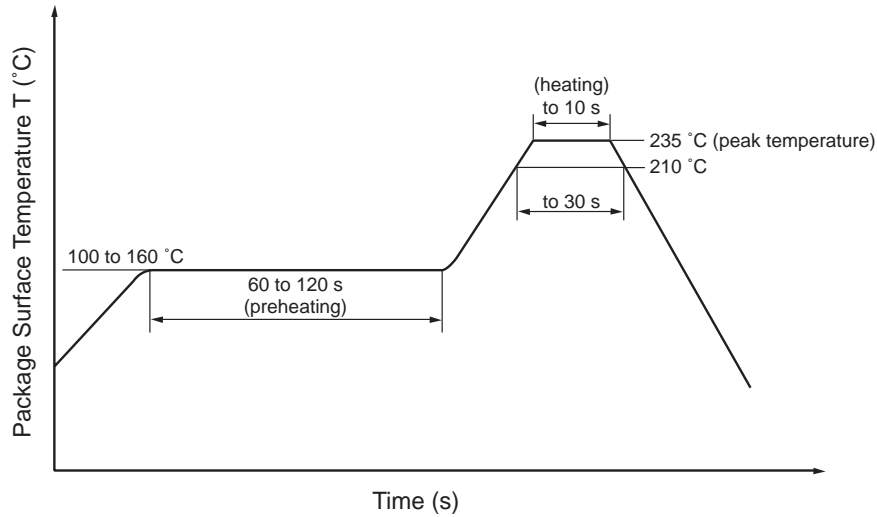

### (2) Dip soldering

- Temperature 260 °C or below (molten solder temperature)
- Time 10 seconds or less
- Number of times One
- Flux Rosin flux containing small amount of chlorine  
(The flux with a maximum chlorine content of 0.2 Wt % is recommended.)

### (3) Cautions

- Fluxes  
Avoid removing the residual flux with freon-based cleaning solvent.
- Avoid shorting between portion of frame and leads.

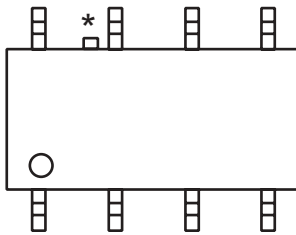

\* Portion of frame

EXCLUSIVE NORTH AMERICAN AGENT FOR NEC RF, MICROWAVE & OPTOELECTRONIC SEMICONDUCTORS