



# **RF-BM-ND04**

## **Bluetooth 5.0 Low Energy Module**







**Version 1.2**

Shenzhen RF-star Technology Co., Ltd.

Sep. 22<sup>nd</sup>, 2020

## Nordic BLE Module List







### ➤ nRF51 Series





Chipset	Core	Flash (Byte)	RAM (KB)	TX Power (dBm)	Model	Antenna	Dimension (mm)	Range (M)	Photo
nRF51822	M0	256K	16	4	RF-BM-ND01	PCB	15 × 24.8	100	
					RF-BM-ND02	PCB	13.5 × 16.2	80	
					RF-BM-ND02I	IPEX	13.5 × 16.2	150	
nRF51802	M0	256K	16	4	RF-BM-ND01C	PCB	15 × 24.8	100	
					RF-BM-ND02C	PCB	13.5 × 16.2	80	
					RF-BM-ND02CI	IPEX	13.5 × 16.2	80	

**Note:**

1. The communication distance is the longest distance obtained by testing the module's maximum transmission power in an open and interference-free environment in sunny weather.
2. Click the picture to buy modules.

## ➤ nRF52 Series

Chipset	Core	Flash (KB)	RAM (KB)	TX Power (dBm)	Model	Antenna	Dimension (mm)	Range (M)	Photo
nRF52832	M4F	512	64	4	RF-BM-ND04	PCB	15 × 24.8	100	
					RF-BM-ND04I	IPEX	15 × 24.8	100	
					RF-BM-ND08	PCB	15.2 × 11.2	80	
					RF-BM-ND08I	IPEX	15.2 × 11.2	100	Contact me
nRF52810	M4	192	24	4	RF-BM-ND04C	PCB	15 × 24.8	100	
					RF-BM-ND04CI	IPEX	15 × 24.8	100	
					RF-BM-ND08C	PCB	15.2 × 11.2	80	
					RF-BM-ND08CI	IPEX	15.2 × 11.2	100	Contact me
nRF52811	M4	192	24	4	RF-BM-ND04A	PCB	15 × 24.8	100	

					RF-BM-ND08A	PCB	15.2 × 11.2	80	
<b>nRF52833</b>	M4	512	128	8	RF-BM-ND07	Chip / IPEX	12.2 × 17	300	
<b>nRF52840</b>	M4F	1024	256	8	RF-BM-ND05	PCB	15 × 24.8	550	
					RF-BM-ND05I	IPEX	15 × 24.8	550+	
					RF-BM-ND06	PCB	20.5 × 24	550	

**Note:**

1. The communication distance is the longest distance obtained by testing the module's maximum transmission power in an open and interference-free environment in sunny weather.
2. Click the picture to buy modules.

## 1 Device Overview

### 1.1 Description

RF-BM-ND04 is an RF module based on Nordic BLE SoC nRF52832QFAA with ARM® Cortex®-M4 32-bit processor. It integrates a 32.768 kHz and a 32 MHz crystal, an LC filter, an antenna matching and a meander line inverted-F PCB antenna. It supports BLE stack v5.0 including the high-speed 2 Mbps feature and can be preprogrammed with a serial interface communication protocols, such as NFC, ANT and 2.4 GHz proprietary for simple programming. RF-BM-ND04 also support Bluetooth mesh which can be run concurrently with Bluetooth LE, enabling smartphones to provision, commission, configure and control mesh nodes. The module has NFC-A Tag for use in simplified pairing and payment solutions. It also has numerous digital peripherals and interfaces such as ADC, PDM, PWM, I<sup>2</sup>C and I<sup>2</sup>S for many applications. It features low power consumption, small size, robust connection distance, and rigid reliability. 1.27-mm pitch stamp stick package for easy assembling and cost-effective PCB design. RF-BM-ND04 is pin-to-pin compatible with RF-BM-ND04C / ND04I / ND04CI / ND05 / ND05I.

### 1.2 Key Features

- RF
  - Bluetooth 5.0 low energy
  - Bluetooth Mesh
  - NFC
  - ANT
  - 2.4 GHz proprietary
- TX power: -20 dBm to +4 dBm
- ARM® Cortex®-M4 32-bit processor with FPU, 64 MHz
- Supply voltage range 1.7 V ~ 3.6 V
- Memory
  - 512 kB flash
  - 64 kB RAM
- Rich peripherals
  - NFC-A
  - 12-bit, 200 ksps ADC
  - 29 GPIOs
  - PWM
  - PDM
  - SPI master / slave
  - I<sup>2</sup>C master / slave
  - I<sup>2</sup>S
  - UART (CTS / RTS)
- Transmission Range: 100 m
- Dimension: 24.8 mm x 15.0 mm x (2.3 ± 0.1) mm
- Certificates: FCC, SRRC

### 1.3 Applications

- Internet of Things (IoT)
- Internet gateway
- Industrial control
- Home automation
- Smart plug and metering
- Beacons
- Access control
- IP Network sensor nodes
- Security systems
- Wearables
- Building automation
- Retail
- Sensor networks
- Medical devices

### 1.4 Functional Block Diagram

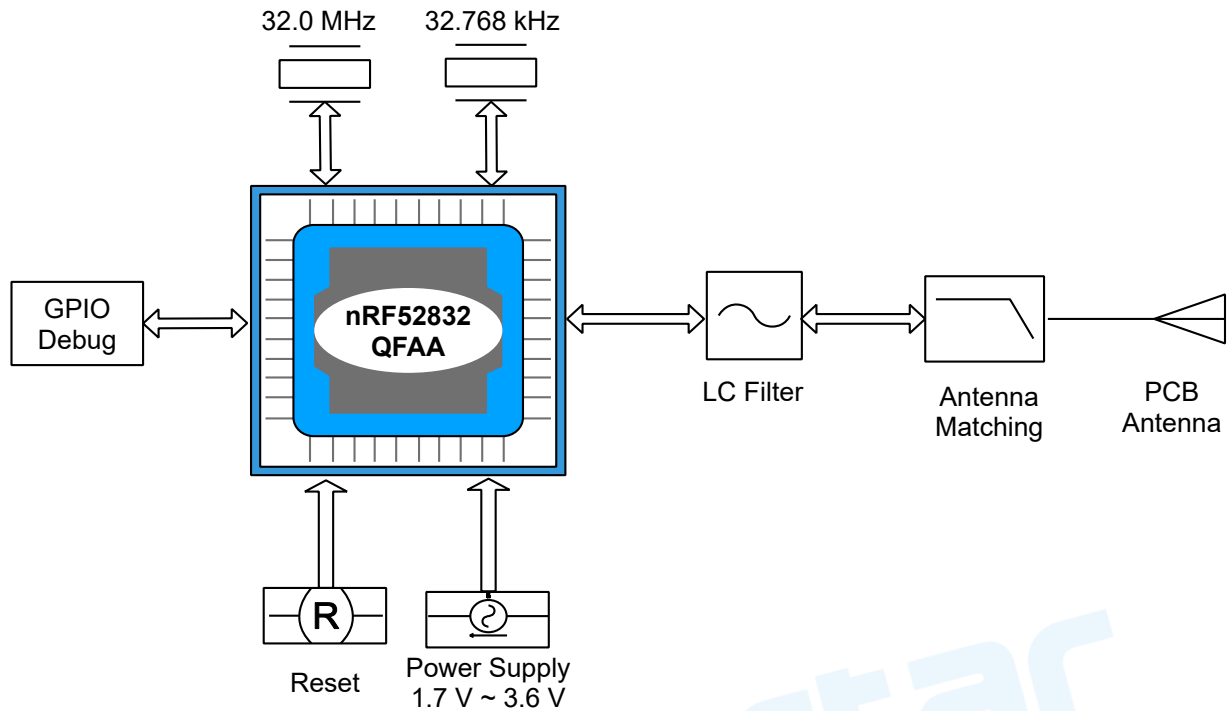

Figure 1. Functional Block Diagram of RF-BM-ND04

### 1.5 Part Number Conventions

The part numbers are of the form of RF-BM-ND04 where the fields are defined as follows:

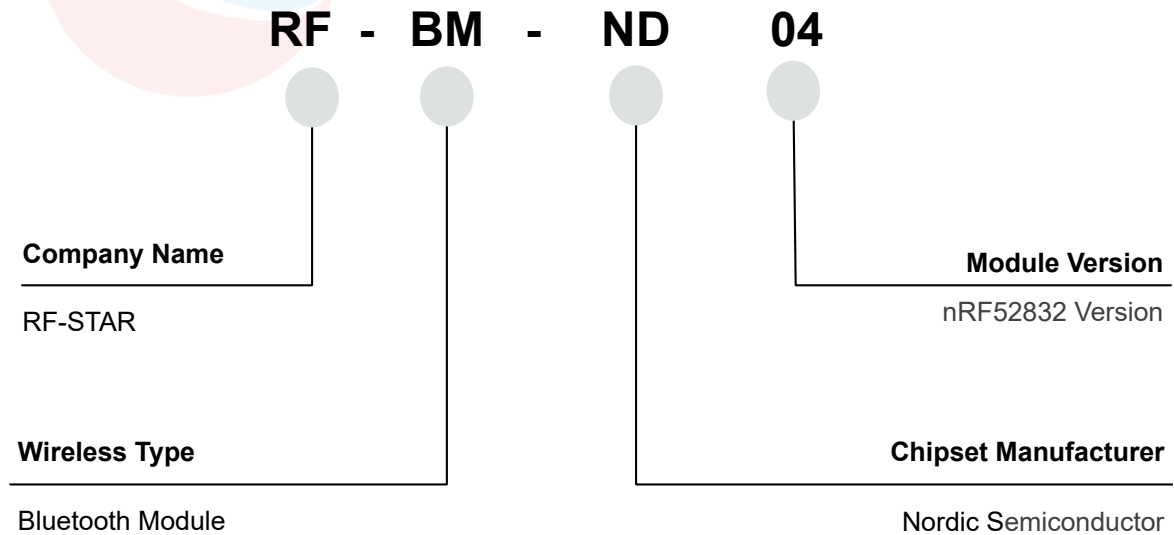

Figure 2. Part Number Conventions of RF-BM-ND04

## Table of Contents

Nordic BLE Module List .....	1
nRF51 Series .....	1
nRF52 Series .....	2
1 Device Overview .....	4
1.1 Description.....	4
1.2 Key Features .....	4
1.3 Applications .....	4
1.4 Functional Block Diagram.....	5
1.5 Part Number Conventions .....	5
Table of Contents.....	6
Table of Figures .....	7
Table of Tables.....	7
2 Module Configuration and Functions .....	8
2.1 Module Parameters .....	8
2.2 Module Pin Diagram .....	9
2.3 Pin Functions.....	9
3 Specifications.....	11
3.1 Recommended Operating Conditions.....	11
3.2 Handling Ratings .....	11
3.3 Power Consumption .....	11
4 Application, Implementation, and Layout .....	12
4.1 Module Photos.....	12
4.2 Recommended PCB Footprint.....	12
4.3 Schematic Diagram .....	13
4.4 Reference Design .....	13
4.5 Basic Operation of Hardware Design.....	14
4.6 Trouble Shooting.....	15
4.6.1 Unsatisfactory Transmission Distance.....	15
4.6.2 Vulnerable Module.....	15
4.6.3 High Bit Error Rate .....	16

4.7 Electrostatics Discharge Warnings .....	16
4.8 Soldering and Reflow Condition .....	16
4.9 Optional Packaging.....	17
5 Certification.....	18
5.1 FCC .....	18
5.2 SRRC .....	18
6 Revision History.....	19
7 Contact Us .....	20

## Table of Figures

Figure 1. Functional Block Diagram of RF-BM-ND04 .....	5
Figure 2. Part Number Conventions of RF-BM-ND04.....	5
Figure 3. Pin Diagram of RF-BM-ND04 .....	9
Figure 4. Photos of RF-BM-ND04.....	12
Figure 5. Recommended PCB Footprint of RF-BM-ND04 (mm).....	12
Figure 6. Schematic Diagram of RF-BM-ND04.....	13
Figure 7. Reference Design of RF-BM-ND04 .....	13
Figure 8. Recommendation of Antenna Layout.....	15
Figure 9. Recommended Reflow for Lead Free Solder.....	17
Figure 10. Optional Packaging Mode .....	17
Figure 11. FCC Certificate .....	18
Figure 12. SRRC Certificate .....	18

## Table of Tables

Table 1. Parameters of RF-BM-ND04 .....	8
Table 2. Pin Functions of RF-BM-ND04.....	9
Table 3. Recommended Operating Conditions of RF-BM-ND04.....	11
Table 4. Handling Ratings of RF-BM-ND04 .....	11
Table 5. Power Consumption.....	11
Table 6. Temperature Table of Soldering and Reflow.....	16



## 2 Module Configuration and Functions

### 2.1 Module Parameters

Table 1. Parameters of RF-BM-ND04

Chipset	nRF52832QFAA
Supply Power Voltage	1.7 V ~ 3.6 V, recommended to 3.3 V
Frequency	2402 MHz ~ 2480 MHz
Transmit Power	-20.0 dBm ~ +4.0 dBm (Typical: 0 dBm)
Receiving Sensitivity	-96 dBm
Data Rate	1 Mbps, 2 Mbps
Power Consumption	5.3 mA peak current in TX (0 dBm) 5.4 mA peak current in RX
GPIO	29
Crystal	32 MHz, 32.768 kHz
RAM	64 KB
Flash	512 KB
Package	SMT Packaging
Frequency Error	±20 kHz
Dimension	24.8 mm x 15.0 mm x (2.3 ± 0.1) mm
Type of Antenna	PCB antenna
Operating Temperature	-40 °C ~ +85 °C
Storage Temperature	-40 °C ~ +125 °C

## 2.2 Module Pin Diagram

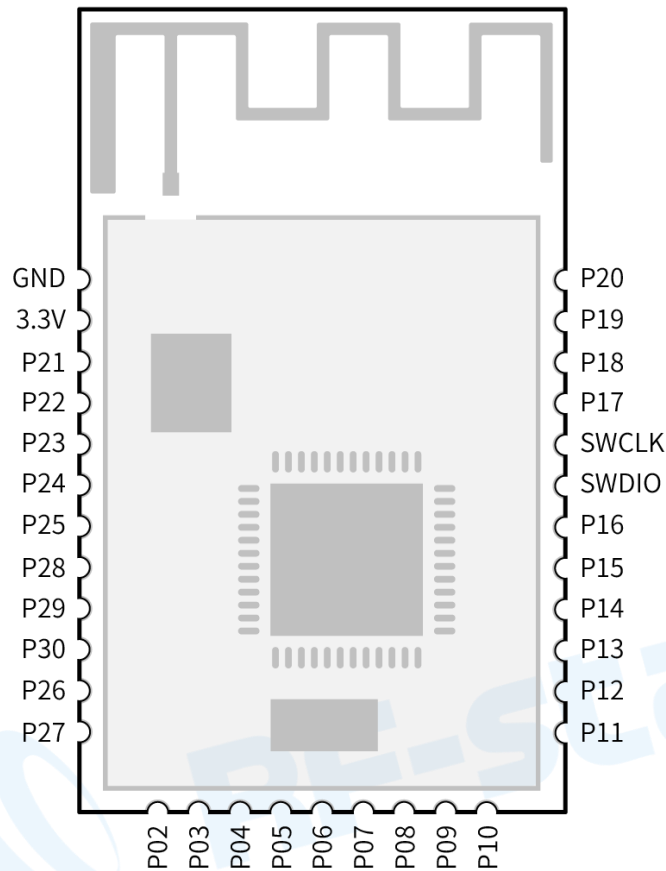

Figure 3. Pin Diagram of RF-BM-ND04

## 2.3 Pin Functions

Table 2. Pin Functions of RF-BM-ND04

Pin	Name	Chip Pin	Pin Type	Description
1	GND	GND	GND	GND
2	VCC	VCC	Power	Power supply 1.7 V ~ 3.6 V, Recommend 3.3 V
3	P21 / RST	P0_21 / RESET	I/O	Reset, active low.
4	P22	P0_22	I/O	
5	P23	P0_23	I/O	
6	P24	P0_24	I/O	
7	P25	P0_25	I/O	
8	P28	P0_28 / AIN4	I/O	
9	P29	P0_29 / AIN5	I/O	

10	P30	P0_30 / AIN6	I/O	
11	P26	P0_26	I/O	
12	P27	P0_27	I/O	
13	P02	P0_2 / AIN0	I/O	
14	P03	P0_3 / AIN1	I/O	
15	P04	P0_4 / AIN2	I/O	
16	P05	P0_5 / AIN3	I/O	
17	P06	P0_6	I/O	
18	P07	P0_7	I/O	
19	P08	P0_8	I/O	
20	P09	P0_9	I/O	
21	P10	P0_10	I/O	
22	P11	P0_11	I/O	
23	P12	P0_12	I/O	
24	P13	P0_13	I/O	
25	P14	P0_14	I/O	
26	P15	P0_15	I/O	
27	P16	P0_16	I/O	
28	SWDIO	JTAG SWD	I/O	Serial wire debug I/O for debug and programming
29	SWCLK	JTAG CLK	I/O	Serial wire debug clock input for debug and programming
30	P17	P0_17	I/O	
31	P18	P0_18	I/O	
32	P19	P0_19	I/O	
33	P20	P0_20	I/O	

### 3 Specifications

#### 3.1 Recommended Operating Conditions

Functional operation does not guarantee performance beyond the limits of the conditional parameter values in the table below. Long-term work beyond this limit will affect the reliability of the module more or less.

Table 3. Recommended Operating Conditions of RF-BM-ND04

Items	Condition	Min.	Typ.	Max.	Unit
Operating Supply Voltage	Battery Mode	1.7	3.3	3.6	V
Operating Temperature	/	-40	+25	+85	°C
Environmental Hot Pendulum	/	-20		+20	°C/min

#### 3.2 Handling Ratings

Table 4. Handling Ratings of RF-BM-ND04

Items	Condition	Min.	Typ.	Max.	Unit
Storage Temperature	Tstg	-40	+25	+125	°C
Human Body Model	HBM		±4000		V
Moisture Sensitivity Level			2		
Charged Device Model			±750		V

#### 3.3 Power Consumption

Table 5. Power Consumption

Event	Average Current	Testing Conditions / Remark
Sleeping	2.62 $\mu$ A	EN disconnected
Broadcast	77.70 $\mu$ A	Broadcast cycle: 200 ms
Broadcast	30.01 $\mu$ A	Broadcast cycle: 500 ms
Broadcast	15.64 $\mu$ A	Broadcast cycle: 1000 ms
Broadcast	8.90 $\mu$ A	Broadcast cycle: 2000 ms
Broadcast	4.27 $\mu$ A	Broadcast cycle: 5000 ms
Connection	72.80 $\mu$ A	Connection cycle: 50 ms
Connection	38.28 $\mu$ A	Connection cycle: 100 ms

## 4 Application, Implementation, and Layout

### 4.1 Module Photos

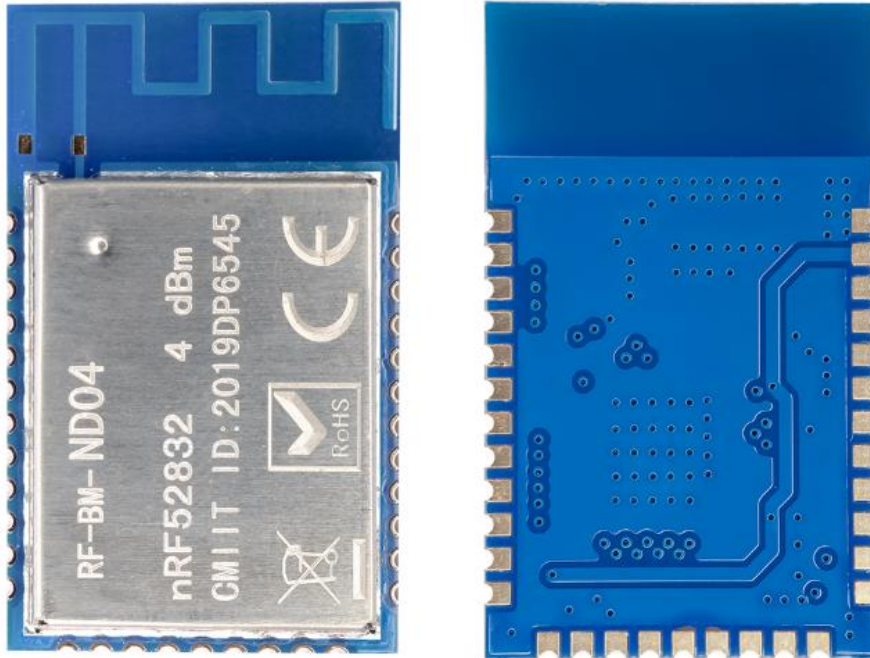

Figure 4. Photos of RF-BM-ND04

### 4.2 Recommended PCB Footprint

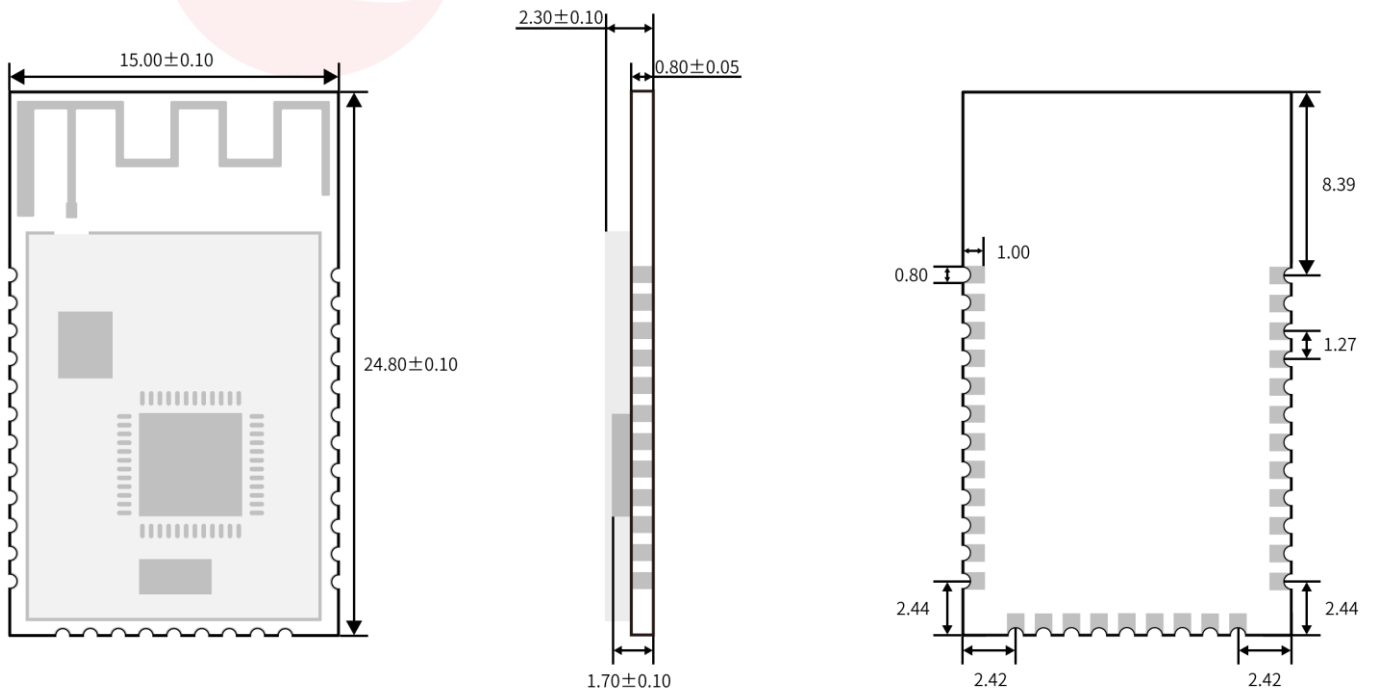

Figure 5. Recommended PCB Footprint of RF-BM-ND04 (mm)

### 4.3 Schematic Diagram

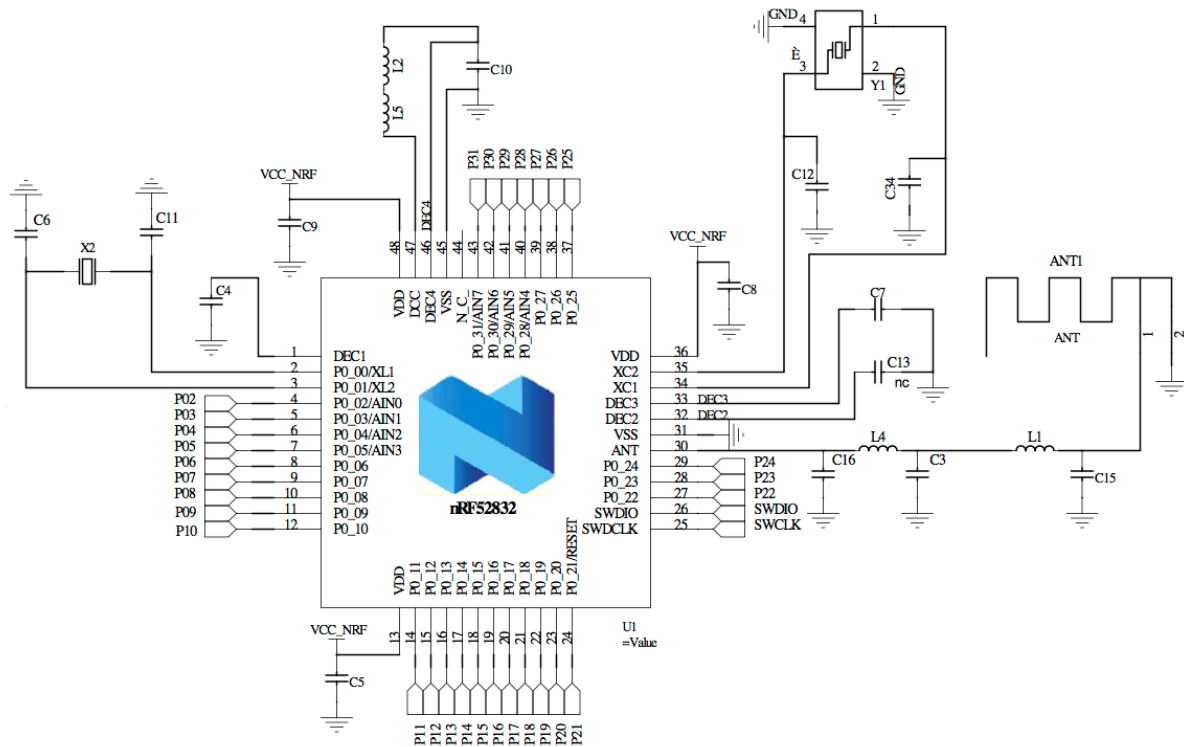

Figure 6. Schematic Diagram of RF-BM-ND04

### 4.4 Reference Design

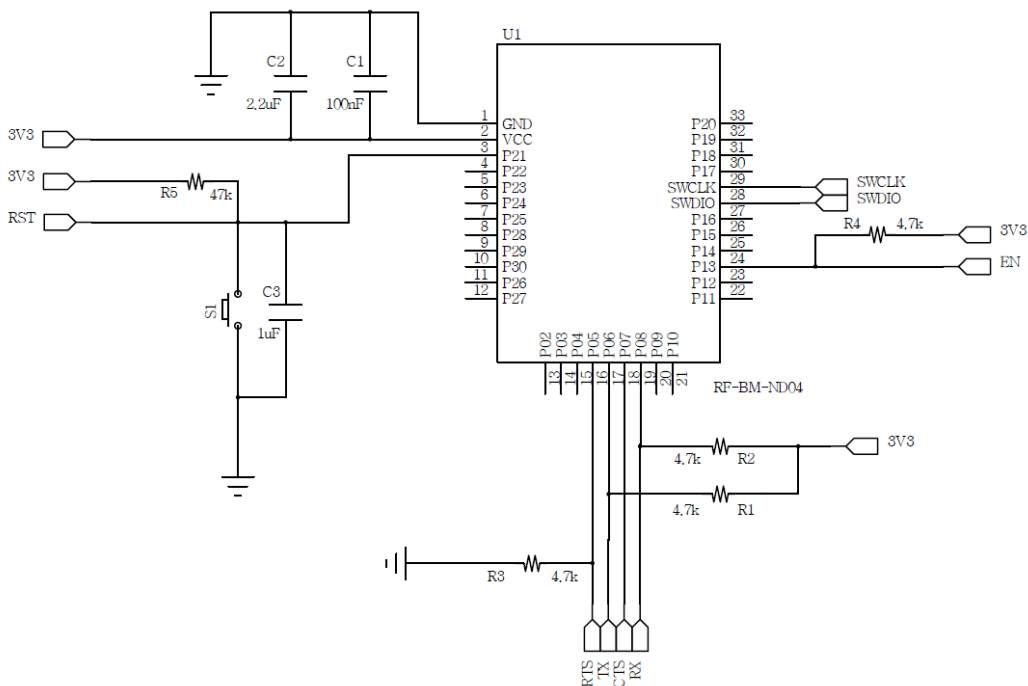

Figure 7. Reference Design of RF-BM-ND04

## 4.5 Basic Operation of Hardware Design

1. It is recommended to offer the module with a DC stabilized power supply, a tiny power supply ripple coefficient and the reliable ground. Please pay attention to the correct connection between the positive and negative poles of the power supply. Otherwise, the reverse connection may cause permanent damage to the module;
2. Please ensure the supply voltage is between the recommended values. The module will be permanently damaged if the voltage exceeds the maximum value. Please ensure the stable power supply and no frequently fluctuated voltage.
3. When designing the power supply circuit for the module, it is recommended to reserve more than 30% of the margin, which is beneficial to the long-term stable operation of the whole machine. The module should be far away from the power electromagnetic, transformer, high-frequency wiring and other parts with large electromagnetic interference.
4. The bottom of module should avoid high-frequency digital routing, high-frequency analog routing and power routing. If it has to route the wire on the bottom of module, for example, it is assumed that the module is soldered to the Top Layer, the copper must be spread on the connection part of the top layer and the module, and be close to the digital part of module and routed in the Bottom Layer (all copper is well grounded).
5. Assuming that the module is soldered or placed in the Top Layer, it is also wrong to randomly route the Bottom Layer or other layers, which will affect the spurs and receiving sensitivity of the module to some degrees;
6. Assuming that there are devices with large electromagnetic interference around the module, which will greatly affect the module performance. It is recommended to stay away from the module according to the strength of the interference. If circumstances permit, appropriate isolation and shielding can be done.
7. Assuming that there are routings of large electromagnetic interference around the module (high-frequency digital, high-frequency analog, power routings), which will also greatly affect the module performance. It is recommended to stay away from the module according to the strength of the interference. If circumstances permit, appropriate isolation and shielding can be done.
8. It is recommended to stay away from the devices whose TTL protocol is the same 2.4 GHz physical layer, for example: USB 3.0.
9. The antenna installation structure has a great influence on the module performance. It is necessary to ensure the antenna is exposed and preferably vertically upward. When the module is installed inside of the case, a high-quality antenna extension wire can be used to extend the antenna to the outside of the case.
10. The antenna must not be installed inside the metal case, which will cause the transmission distance to be greatly weakened.
11. The recommendation of antenna layout.

The inverted-F antenna position on PCB is free space electromagnetic radiation. The location and layout of antenna is a key factor to increase the data rate and transmission range.

Therefore, the layout of the module antenna location and routing is recommended as follows:

- (1) Place the antenna on the edge (corner) of the PCB.

- (2) Make sure that there is no signal line or copper foil in each layer below the antenna.
- (3) It is the best to hollow out the antenna position in the following figure so as to ensure that S11 of the module is minimally affected.

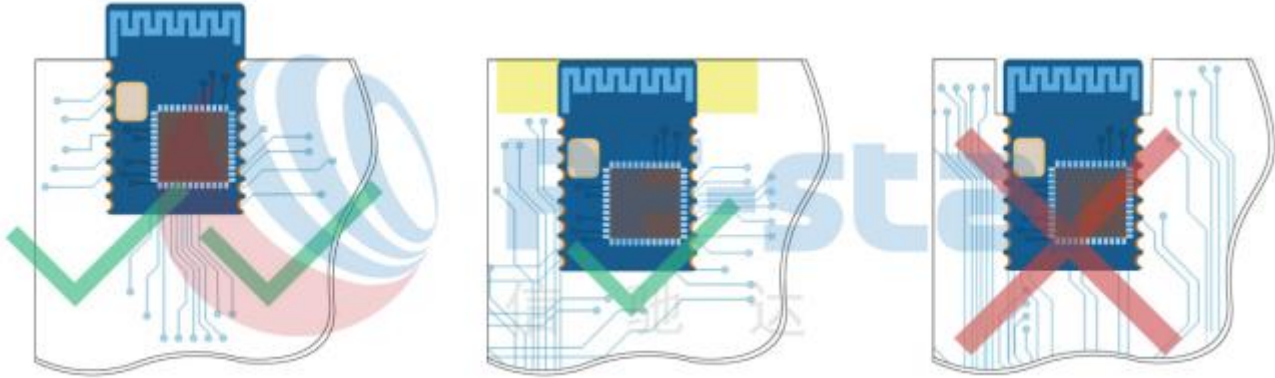

Figure 8. Recommendation of Antenna Layout

Note: The hollow-out position is based on the antenna used.

## 4.6 Trouble Shooting

### 4.6.1 Unsatisfactory Transmission Distance

1. When there is a linear communication obstacle, the communication distance will be correspondingly weakened. Temperature, humidity, and co-channel interference will lead to an increase in communication packet loss rate. The performances of ground absorption and reflection of radio waves will be poor, when the module is tested close to the ground.
2. Seawater has a strong ability to absorb radio waves, so the test results by seaside are poor.
3. The signal attenuation will be very obvious, if there is a metal near the antenna or the module is placed inside of the metal shell.
4. The incorrect power register set or the high data rate in an open air may shorten the communication distance. The higher the data rate, the closer the distance.
5. The low voltage of the power supply is lower than the recommended value at ambient temperature, and the lower the voltage, the smaller the power is.
6. The unmatchable antennas and module or the poor quality of antenna will affect the communication distance.

### 4.6.2 Vulnerable Module

1. Please ensure the supply voltage is between the recommended values. The module will be permanently damaged if the voltage exceeds the maximum value. Please ensure the stable power supply and no frequently fluctuated voltage.
2. Please ensure the anti-static installation and the electrostatic sensitivity of high-frequency devices.



- Due to some humidity sensitive components, please ensure the suitable humidity during installation and application. If there is no special demand, it is not recommended to use at too high or too low temperature.

#### 4.6.3 High Bit Error Rate

- There are co-channel signal interferences nearby. It is recommended to be away from the interference sources or modify the frequency and channel to avoid interferences.
- The unsatisfactory power supply may also cause garbled. It is necessary to ensure the power supply reliability.
- If the extension wire or feeder wire is of poor quality or too long, the bit error rate will be high.

#### 4.7 Electrostatics Discharge Warnings

The module will be damaged for the discharge of static. RF-star suggest that all modules should follow the 3 precautions below:

- According to the anti-static measures, bare hands are not allowed to touch modules.
- Modules must be placed in anti- static areas.
- Take the anti-static circuitry (when inputting HV or VHF) into consideration in product design.  
Static may result in the degradation in performance of module, even causing the failure.

#### 4.8 Soldering and Reflow Condition

- Heating method: Conventional Convection or IR/convection.
- Solder paste composition: Sn96.5 / Ag3.0 / Cu0.5
- Allowable reflow soldering times: 2 times based on the following reflow soldering profile.
- Temperature profile: Reflow soldering shall be done according to the following temperature profile.
- Peak temperature: 245 °C.

Table 6. Temperature Table of Soldering and Reflow

Profile Feature	Sn-Pb Assembly	Pb-Free Assembly
<b>Solder Paste</b>	Sn63 / Pb37	Sn96.5 / Ag3.0 / Cu0.5
<b>Min. Preheating Temperature (<math>T_{min}</math>)</b>	100 °C	150 °C
<b>Max. Preheating Temperature (<math>T_{max}</math>)</b>	150 °C	200 °C
<b>Preheating Time (<math>T_{min}</math> to <math>T_{max}</math>) (<math>t_1</math>)</b>	60 s ~ 120 s	60 s ~ 120 s
<b>Average Ascend Rate (<math>T_{max}</math> to <math>T_p</math>)</b>	Max. 3 °C/s	Max. 3 °C/s
<b>Liquid Temperature (<math>T_L</math>)</b>	183 °C	217 °C
<b>Time above Liquidus (<math>t_L</math>)</b>	60 s ~ 90 s	30 s ~ 90 s
<b>Peak Temperature (<math>T_p</math>)</b>	220 °C ~ 235 °C	230 °C ~ 250 °C
<b>Average Descend Rate (<math>T_p</math> to <math>T_{max}</math>)</b>	Max. 6 °C/s	Max. 6 °C/s

<b>Time from 25 °C to Peak Temperature (<math>t_2</math>)</b>	Max. 6 minutes	Max. 8 minutes
<b>Time of Soldering Zone (<math>t_P</math>)</b>	20±10 s	20±10 s

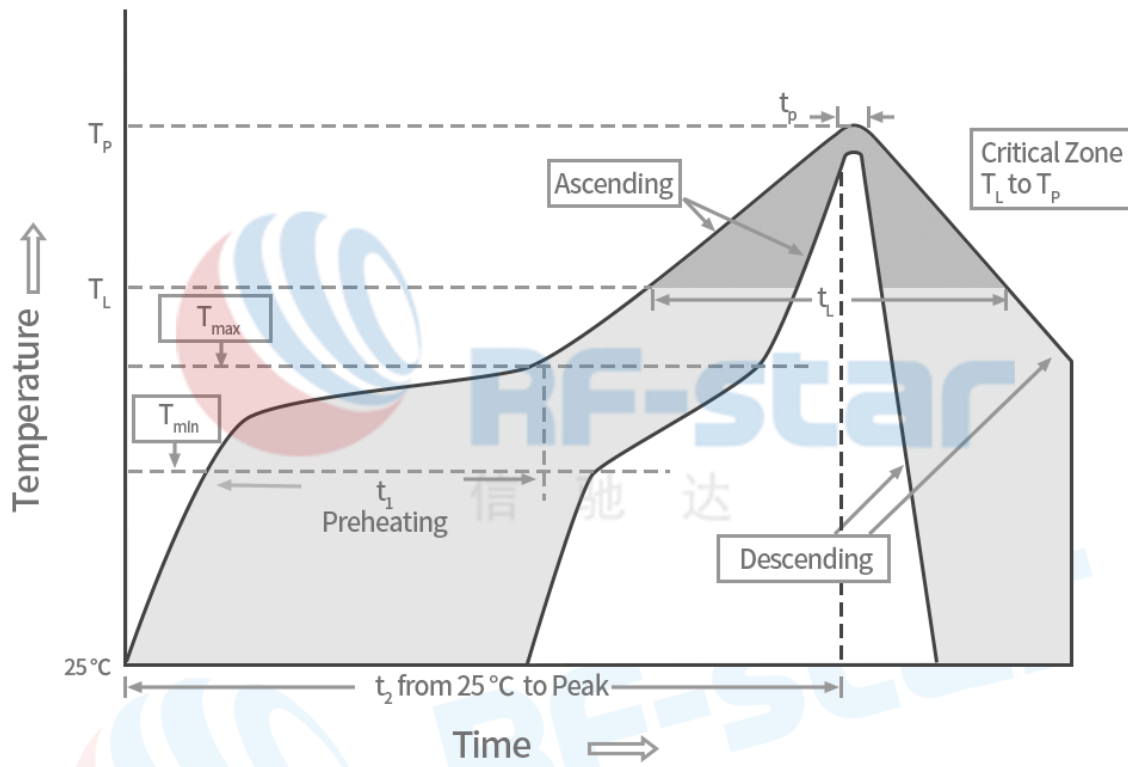

Figure 9. Recommended Reflow for Lead Free Solder

#### 4.9 Optional Packaging



Figure 10. Optional Packaging Mode

Note: Default tray packaging.

## 5 Certification

### 5.1 FCC

Warnings:

This device complies with part 15 of the FCC Rules. Operation is subject to the following two conditions: (1) This device may not cause harmful interference, and (2) this device must accept any interference received, including interference that may cause undesired operation.

FCC ID: 2ABN2-FBMND04



Figure 11. FCC Certificate

### 5.2 SRRC

SRRC ID: 2019DP6546



Figure 12. SRRC Certificate

## 6 Revision History

Date	Version No.	Description	Author
2017.01.10	V1.0	The initial version is released.	Aroo Wang
2018.01.24	V1.1	Update module picture.	Aroo Wang
2018.03.02	V1.2	Update module parameters.	Aroo Wang
2018.08.02	V1.2	Update company address.	Aroo Wang
2020.01.10	V1.2	Add Nordic BLE module list.	Sunny Li
2020.03.31	V1.2	Modify reset pin	Sunny Li
2020.05.15	V1.2	Update Nordic BLE module list.	Sunny Li
2020.09.22	V1.2	Add reference design. Update Nordic BLE module list.	Sunny Li

Note:

1. The document will be optimized and updated from time to time. Before using this document, please make sure it is the latest version.
2. To obtain the latest document, please download it from the official website: [www.szrfstar.com](http://www.szrfstar.com).

## 7 Contact Us

### SHENZHEN RF-STAR TECHNOLOGY CO., LTD.

#### Shenzhen HQ:

Add.: Room 601, Block C, Skyworth Building, High-tech Park, Nanshan District, Shenzhen, Guangdong, China

Tel.: 86-755-3695 3756

#### Chengdu Branch:

Add.: No. B3-03, Building No.1, Incubation Park, High-Tech District, Chengdu, Sichuan, China, 610000

Tel.: 86-28-6577 5970

Email: [sunny@szrfstar.com](mailto:sunny@szrfstar.com), [sales@szrfstar.com](mailto:sales@szrfstar.com)

Web.: [www.szrfstar.com](http://www.szrfstar.com)

