

# T6A40

## ROW DRIVER FOR A DOT MATRIX LCD

The T6A40 is a 68-channel-output row driver for an STN dot matrix LCD. The T6A40 features -28 V LCD drive voltage. The T6A40 is able to drive LCD panels with a duty ratio of up to 1/240. It is recommended for use with the T6A39/T6A39A.

### FEATURES

- Display duty application : to 1/240
- LCD drive signal : 68
- Data transfer : 1-bit bidirectional
  - ① O68 ← O1
  - ② O68 → O1
  - ③ O1 → O34, O35 ← O68
- LCD drive voltage : -8 to -28 V (max -30 V)
- Operating voltage : 4.5 to 5.5 V
- Operating temperature : -20 to 75°C
- LCD drive output resistance : 1.5 kΩ (max) (12.8 V, 1/9 bias)
- LCD drive output timing : Change on falling edge of LP

### BLOCK DIAGRAM

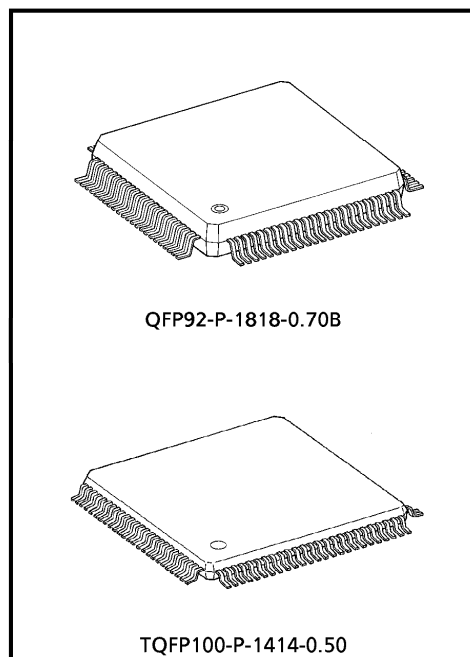
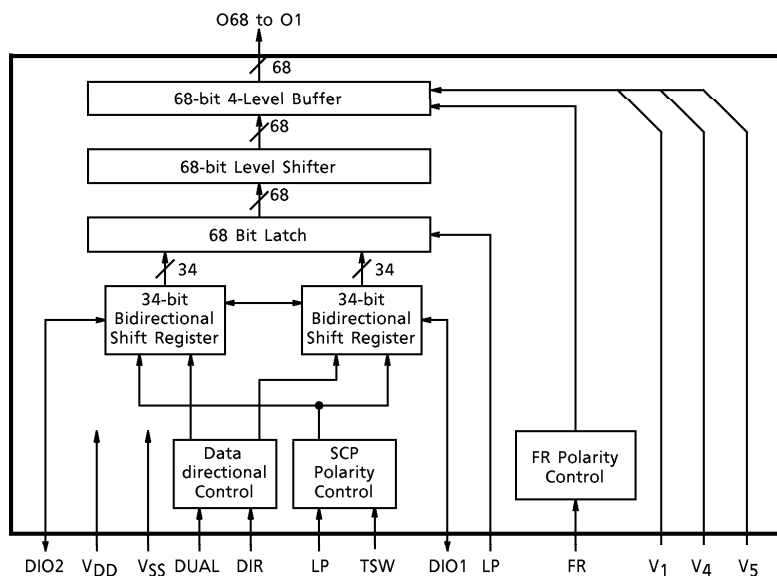

Weight  
 QFP92-P-1818-0.70B : 1.45 g (Typ.)  
 TQFP100-P-1414-0.50 : 0.45 g (Typ.)

980910EBA2

- TOSHIBA is continually working to improve the quality and the reliability of its products. Nevertheless, semiconductor devices in general can malfunction or fail due to their inherent electrical sensitivity and vulnerability to physical stress. It is the responsibility of the buyer, when utilizing TOSHIBA products, to observe standards of safety, and to avoid situations in which a malfunction or failure of a TOSHIBA product could cause loss of human life, bodily injury or damage to property. In developing your designs, please ensure that TOSHIBA products are used within specified operating ranges as set forth in the most recent products specifications. Also, please keep in mind the precautions and conditions set forth in the TOSHIBA Semiconductor Reliability Handbook.
- The products described in this document are subject to the foreign exchange and foreign trade laws.
- The information contained herein is presented only as a guide for the applications of our products. No responsibility is assumed by TOSHIBA CORPORATION for any infringements of intellectual property or other rights of the third parties which may result from its use. No license is granted by implication or otherwise under any intellectual property or other rights of TOSHIBA CORPORATION or others.
- The information contained herein is subject to change without notice.

**PIN ASSIGNMENT**  
**QFP92-P-1818-0.70B**

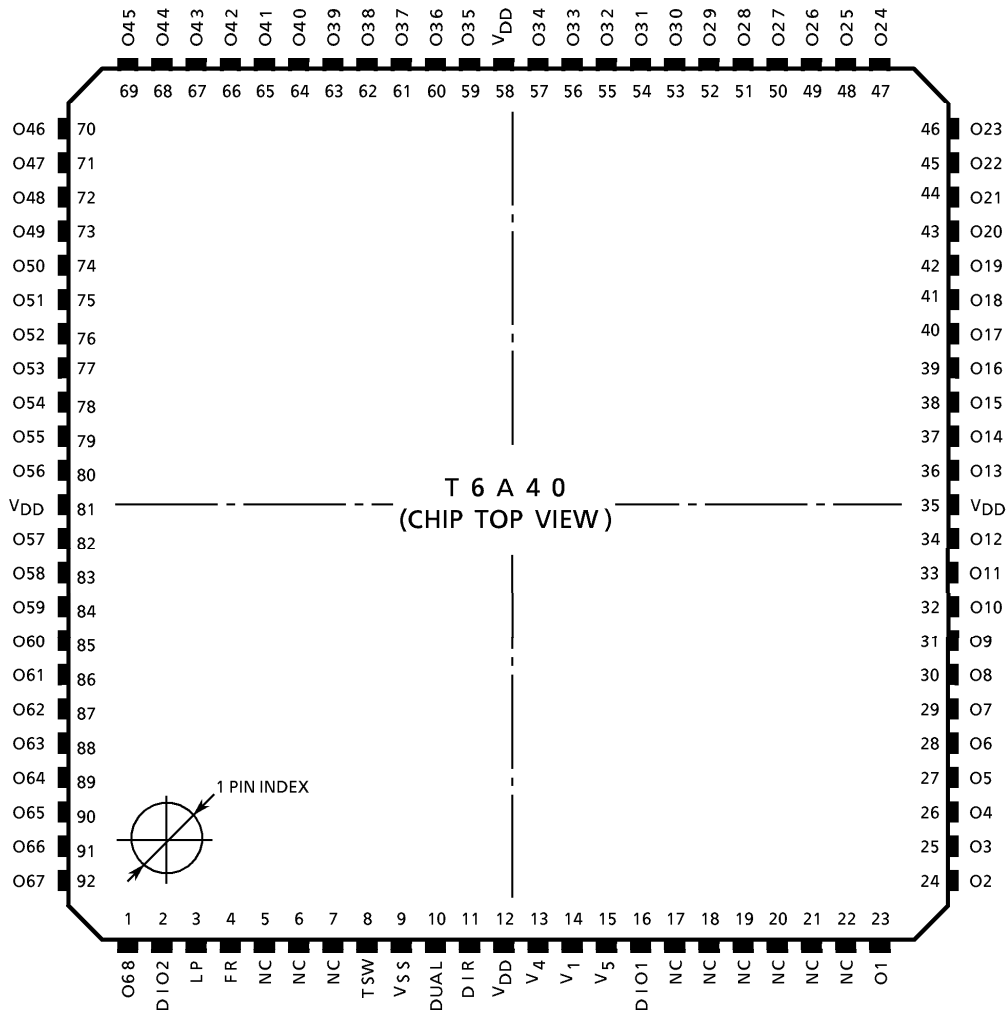

**PIN ASSIGNMENT**  
TQFP100-P-1414-0.50

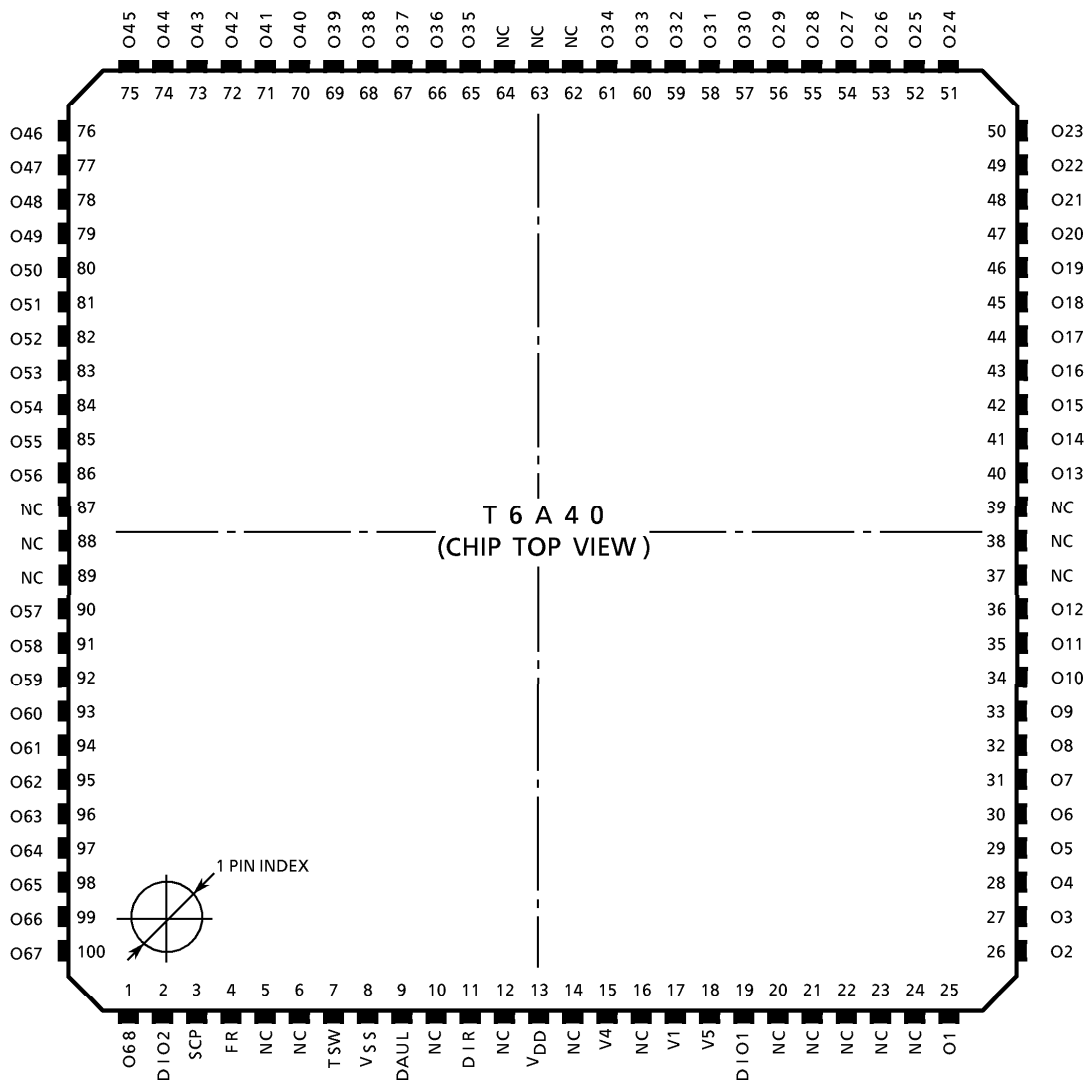

**PIN FUNCTIONS**

PIN NAME	I/O	FUNCTIONS	LEVEL
O1 to O68	Output	Output for LCD drive signal	V <sub>DD</sub> to V <sub>5</sub>
DIO1, DIO2	I/O	Input/output for shift data	V <sub>DD</sub> to V <sub>SS</sub>
LP	Input	(Shift Clock Pulse) Input for shift clock pulse	
FR	Input	(Frame) Input for frame signal	
DUAL	Input	(Dual Mode) Terminal for dual input mode or single input mode select	
DIR	Input	(Direction) Input for data flow direction select	
TSW	Input	(Terminal Switch) When tied to V <sub>SS</sub> : (O1 to O68) output on the rising edge of LP When tied to V <sub>DD</sub> : (O1 to O68) output on the falling edge of LP	
V <sub>DD</sub>	—	Power supply for internal logic (5 V)	—
V <sub>SS</sub>	—	Power supply for internal logic (0 V)	
V <sub>1</sub>	—	Power supply for LCD drive circuit	
V <sub>4</sub>	—	Power supply for LCD drive circuit	
V <sub>5</sub>	—	Power supply for LCD drive circuit	

**RELATION BETWEEN FR, DATA INPUT AND OUTPUT LEVEL**

FR	DATA INPUT (DIO1, DIO2)	OUTPUT LEVEL
L	L	V <sub>1</sub>
L	H	V <sub>5</sub>
H	L	V <sub>4</sub>
H	H	V <sub>DD</sub>

**DATA INPUT FORMAT**

DUAL	DIR	DATA FLOW	DATA INPUT	
			DIO1	DIO2
V <sub>DD</sub>	V <sub>DD</sub>	O1 → O34	IN	IN
		O68 → O35		
V <sub>SS</sub>	V <sub>DD</sub>	O1 → O68	IN	OUT
V <sub>DD</sub>	V <sub>SS</sub>	O68 → O1	OUT	IN
V <sub>SS</sub>	V <sub>SS</sub>			

TIMING DIAGRAM

DIR = H, DUAL = L, TSW = H

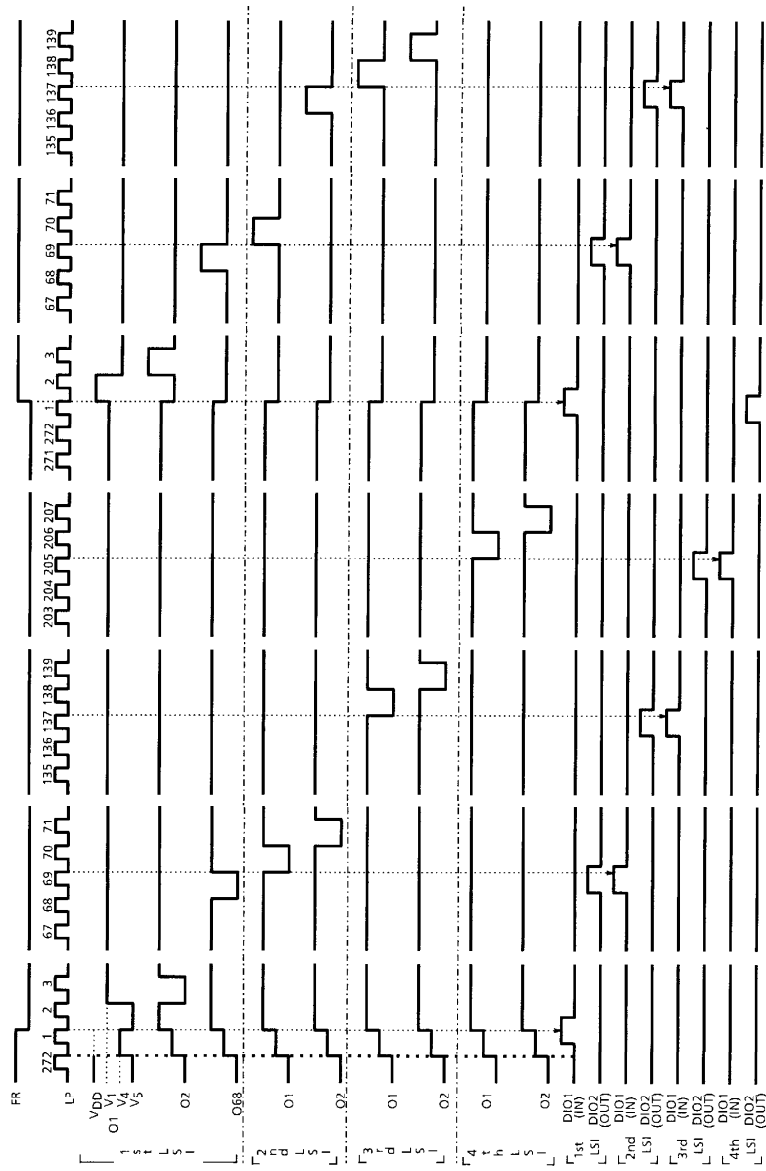

T6A40-5

**ABSOLUTE MAXIMUM RATINGS**(Ensure that the following conditions are maintained,  $V_{DD} \geq V_1 \geq V_4 \geq V_5$ ,  $V_{SS} = 0\text{ V}$ )

ITEM	SYMBOL	PIN NAME	RATING	UNIT
Supply Voltage 1	$V_{DD}$	$V_{DD}$	-0.3 to 7.0	V
Supply Voltage 2	$V_1$	$V_1$	$V_{DD} - 30.0$ to $V_{DD} + 0.3$	V
Supply Voltage 3	$V_4$	$V_4$	$V_{DD} - 30.0$ to $V_{DD} + 0.3$	V
Supply Voltage 4	$V_5$	$V_5$	$V_{DD} - 30.0$ to $V_{DD} + 0.3$	V
Input Voltage	$V_{IN}$	(*1)	-0.3 to $V_{DD} + 0.3$	V
Operating Temperature	$T_{opr}$	—	-20 to 75	°C
Storage Temperature	$T_{stg}$	—	-55 to 125	°C

(\*1) : FR, DIR, DIO1, DIO2, DUAL, TSW, LP

**ELECTRICAL CHARACTERISTICS****DC CHARACTERISTICS**TEST CONDITIONS (Unless otherwise noted,  $V_{SS} = 0\text{ V}$ ,  $V_{DD} = 4.5\text{ V}$  to  $5.5\text{ V}$ ,  
 $V_5 = (V_{DD} - 23)\text{ V} \pm 10\%$ ,  $T_a = -20$  to  $75^\circ\text{C}$ )

ITEM	SYMBOL	TEST CIR-CUIT	TEST CONDITION	MIN	TYP.	MAX	UNIT	PIN NAME	
Supply Voltage 1	$V_{DD}$	—	—	4.5	5.0	5.5	V	$V_{DD}$	
Supply Voltage 2	$V_5$	—	—	$V_{DD} - 28$	—	$V_{DD} - 8.0$	V	$V_5$	
Input Voltage	H Level	$V_{IH}$	(*2)	$V_{DD} - 0.8$	—	$V_{DD}$	V	FR, DIR, DIO1, DIO2, DUAL, LP, TSW	
	L Level	$V_{IL}$	(*2)	0	—	0.8			
Output Voltage	H Level	$V_{OH}$	$I_{OH} = -0.5\text{ mA}$	$V_{DD} - 0.5$	—	$V_{DD}$	V	DIO1, DIO2	
	L Level	$V_{OL}$		$I_{OL} = 0.5\text{ mA}$	—	—			0.5
Output Resistance	H Level	$R_{OH}$	—	$V_{OUT} = V_{DD} - 0.5\text{ V}$ (*3)	—	—	1.2	k $\Omega$	O1 to O68
	M Level	$R_{OM}$		$V_{OUT} = V_1 \pm 0.5\text{ V}$ (*3)	—	—	1.2		
	M Level	$R_{OM}$		$V_{OUT} = V_4 \pm 0.5\text{ V}$ (*3)	—	—	1.2		
	L Level	$R_{OL}$		$V_{OUT} = V_5 + 0.5\text{ V}$ (*3)	—	—	1.2		
Current Consumption	$I_{SS}$	—	$V_{DD} = 5.5\text{ V}$ $V_5 = -22.5\text{ V}$ $f_{FR} = 35.5\text{ Hz}$ $f_{LP} = 7.1\text{ kHz}$ O1 to O68 : no load	Input Data : $f_{DIO} = 71\text{ Hz}$ (Duty : 1 / 100) Input Voltage : H = $V_{DD}$ L = $V_{SS}$ (*3)	—	2.0	4.0	$\mu\text{A}$	$V_{SS}$

(\*2) :  $R_L = 3\text{ k}\Omega$ ,  $C_L = 1500\text{ pF}$ (\*3) :  $V_{DD} = 5.0\text{ V}$ ,  $V_5 = -7.8\text{ V}$ ,  $V_1 = V_{DD} - 1/9 (V_{DD} - V_5)$ ,  $V_4 = V_{DD} - 8/9 (V_{DD} - V_5)$

**AC CHARACTERISTICS**

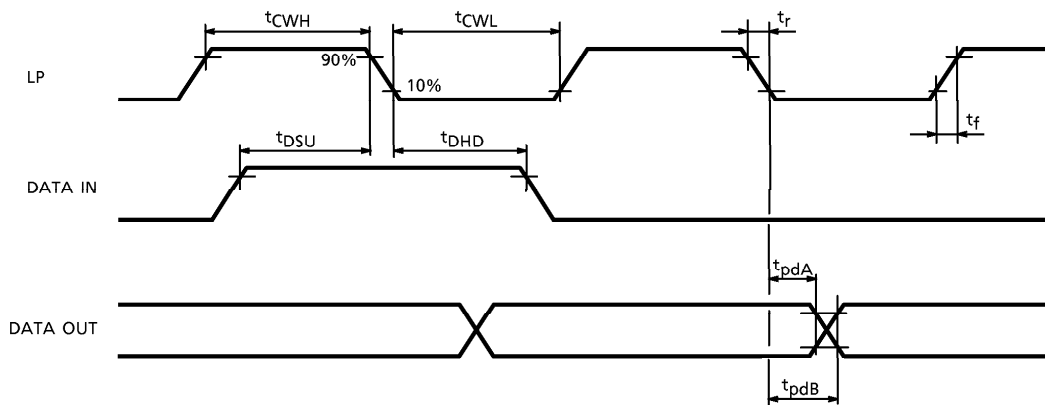

TEST CONDITIONS ( $V_{SS} = 0V$ ,  $V_{DD} = 4.5$  to  $5.5V$ ,  $V_5 = (V_{DD} - 23)V \pm 10\%$ ,  $T_a = -20$  to  $75^\circ C$ )

ITEM	SYMBOL	TEST CONDITION	MIN	MAX	UNIT
SCP Pulse Width H	$t_{CWH}$	LP	30	—	ns
SCP Pulse Width L	$t_{CWL}$	LP	1	—	$\mu s$
Input Rise / Fall Time	$t_r, t_f$	LP, FR, DIO1, DIO2	—	50	ns
Data Set-up Time	$t_{DSU}$	DIO1, DIO2	30	—	ns
Data Hold Time	$t_{DHD}$	DIO1, DIO2	50	—	ns
Output Data Delay Time A	$t_{pdA}$	DIO1, DIO2 (*4)	80	—	ns
Output Data Delay Time B	$t_{pdB}$	DIO1, DIO2 (*4)	—	1	$\mu s$

(\*4) :  $C_L = 10$  pF

**NOTE**

Insert the bypass capacitor ( $0.1 \mu F$ ) between  $V_{DD}$  and  $V_{SS}$  to decrease power supply noise.  
Place the bypass capacitor as close to the LSI as possible.

**OUTLINE DRAWING**  
QFP92-P-1818-0.70B

Unit : mm

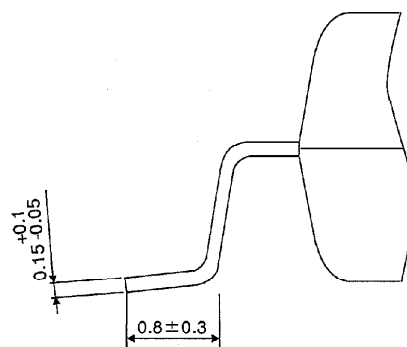
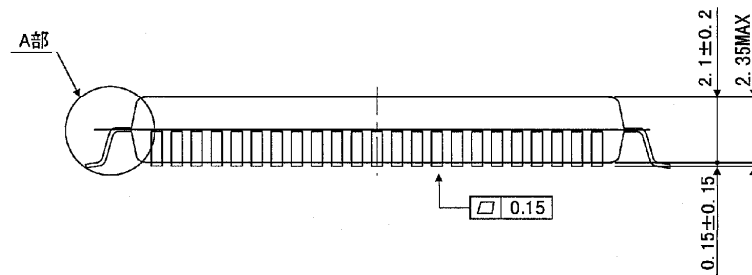
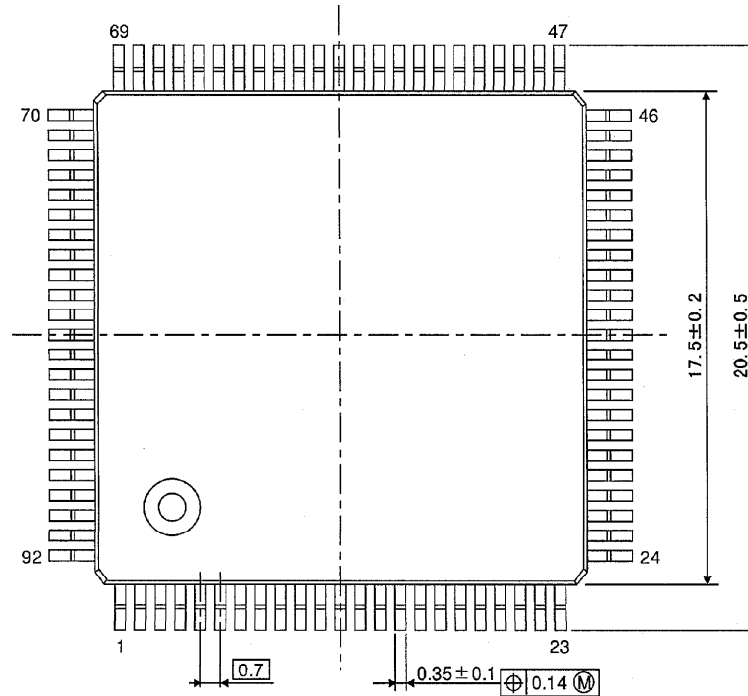

Weight : 1.45 g (Typ.)



**OUTLINE DRAWING**  
TQFP100-P-1414-0.50

Unit : mm

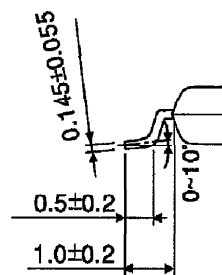
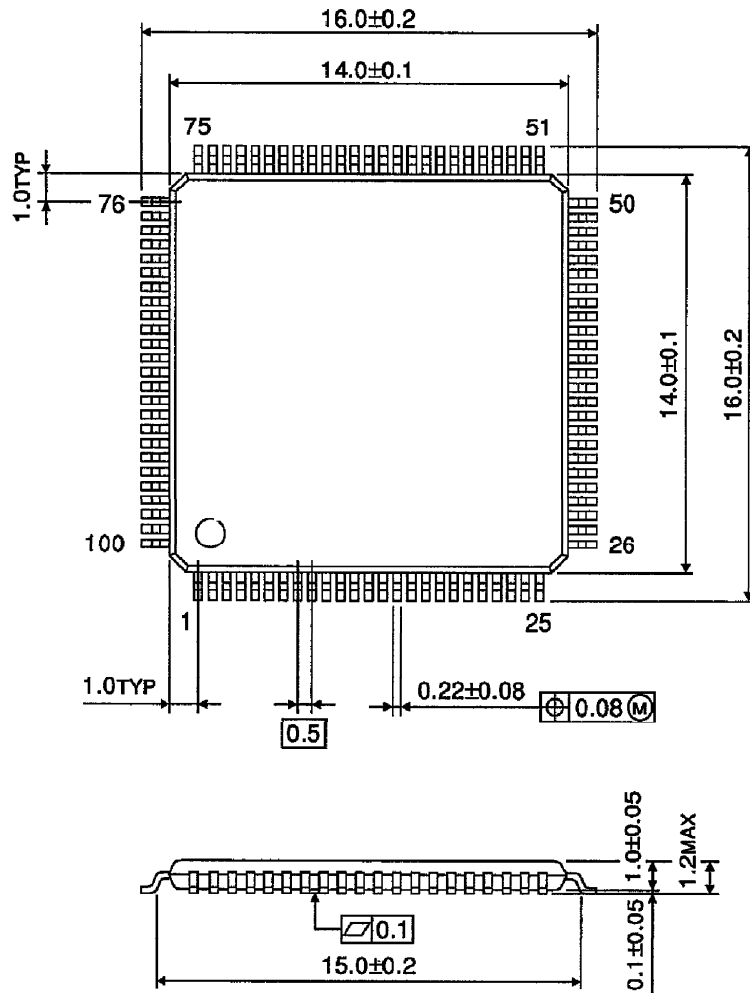

Weight : 0.45 g (Typ.)