

BCR12CM

MEDIUM POWER USE
NON-INSULATED TYPE, PLANAR PASSIVATION TYPE

BCR12CM

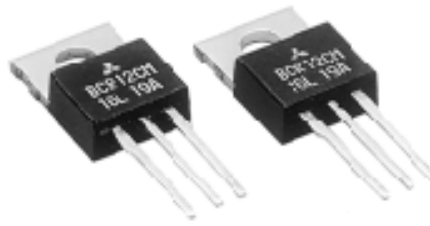

- I_T (RMS) **12A**
- V_{DRM} **400V/600V**
- $I_{FGT I}$, $I_{RGT I}$, $I_{RGT III}$ **30mA (20mA) *5**

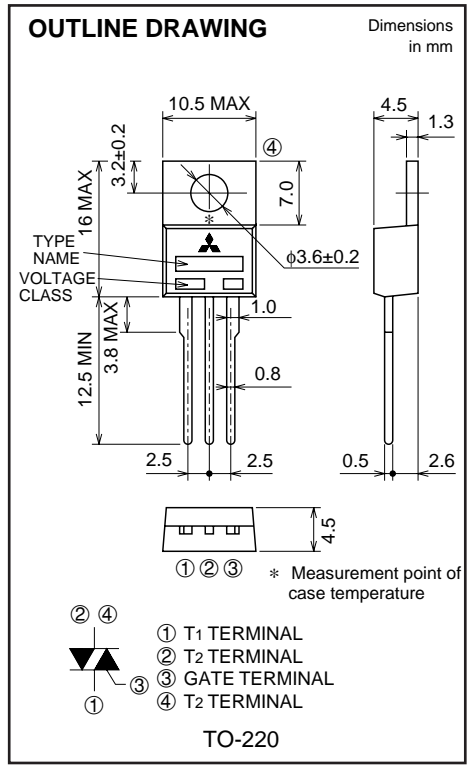

APPLICATION

Contactless AC switches, light dimmer, electric flasher unit, control of household equipment such as TV sets · stereo · refrigerator · washing machine · infrared kotatsu · carpet · electric fan, solenoid drivers, small motor control, copying machine, electric tool, other general purpose control applications

MAXIMUM RATINGS

Symbol	Parameter	Voltage class		Unit
		8	12	
V_{DRM}	Repetitive peak off-state voltage *1	400	600	V
V_{DSM}	Non-repetitive peak off-state voltage *1	500	720	V

Symbol	Parameter	Conditions	Ratings	Unit
I_T (RMS)	RMS on-state current	Commercial frequency, sine full wave 360° conduction, $T_c=98^\circ\text{C}$	12	A
I_{TSM}	Surge on-state current	60Hz sinewave 1 full cycle, peak value, non-repetitive	120	A
I_t^2	I_t^2 for fusing	Value corresponding to 1 cycle of half wave 60Hz, surge on-state current	60	A^2s
PGM	Peak gate power dissipation		5	W
PG (AV)	Average gate power dissipation		0.5	W
VGM	Peak gate voltage		10	V
IGM	Peak gate current		2	A
T_j	Junction temperature		-40 ~ +125	$^\circ\text{C}$
T_{stg}	Storage temperature		-40 ~ +125	$^\circ\text{C}$
—	Weight	Typical value	2.0	g

*1. Gate open.

BCR12CM

MEDIUM POWER USE

NON-INSULATED TYPE, PLANAR PASSIVATION TYPE

ELECTRICAL CHARACTERISTICS

Symbol	Parameter	Test conditions	Limits			Unit	
			Min.	Typ.	Max.		
IDRM	Repetitive peak off-state current	$T_j=125^\circ\text{C}$, V_{DRM} applied	—	—	2.0	mA	
V _{TM}	On-state voltage	$T_c=25^\circ\text{C}$, $I_{\text{TM}}=20\text{A}$, Instantaneous measurement	—	—	1.6	V	
V _{FGT I}	Gate trigger voltage *2	$T_j=25^\circ\text{C}$, $V_D=6\text{V}$, $R_L=6\Omega$, $R_G=330\Omega$	I	—	—	1.5	V
V _{RGT I}			II	—	—	1.5	V
V _{RGT III}			III	—	—	1.5	V
I _{FGT I}	Gate trigger current *2	$T_j=25^\circ\text{C}$, $V_D=6\text{V}$, $R_L=6\Omega$, $R_G=330\Omega$	I	—	—	30*5	mA
I _{RGT I}			II	—	—	30*5	mA
I _{RGT III}			III	—	—	30*5	mA
V _{GD}	Gate non-trigger voltage	$T_j=125^\circ\text{C}$, $V_D=1/2V_{\text{DRM}}$	0.2	—	—	V	
R _{th(j-c)}	Thermal resistance	Junction to case *4	—	—	1.8	$^\circ\text{C}/\text{W}$	
(dv/dt) _c	Critical-rate of rise of off-state commutating voltage		*3	—	—	V/ μs	

- *2. Measurement using the gate trigger characteristics measurement circuit.
- *3. The critical-rate of rise of the off-state commutating voltage is shown in the table below.
- *4. The contact thermal resistance R_{th(c-f)} in case of greasing is 1.0 $^\circ\text{C}/\text{W}$.
- *5. High sensitivity (IGT \leq 20mA) is also available. (IGT item ①)

Voltage class	V _{DRM} (V)	(dv/dt) _c			Test conditions	Commutating voltage and current waveforms (inductive load)
		Symbol	Min.	Unit		
8	400	R	—	V/ μs	1. Junction temperature $T_j=125^\circ\text{C}$ 2. Rate of decay of on-state commutating current $(di/dt)_c=-6\text{A}/\text{ms}$ 3. Peak off-state voltage $V_D=400\text{V}$	
		L	10			
12	600	R	—			
		L	10			

PERFORMANCE CURVES

MAXIMUM ON-STATE CHARACTERISTICS

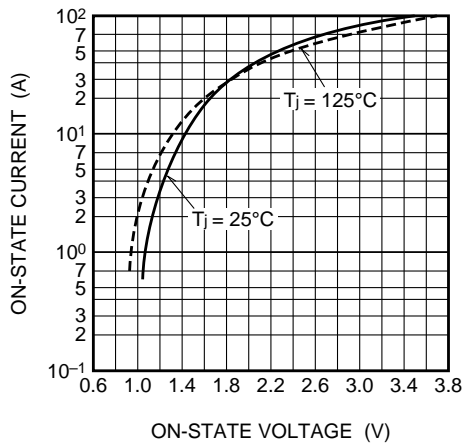

RATED SURGE ON-STATE CURRENT

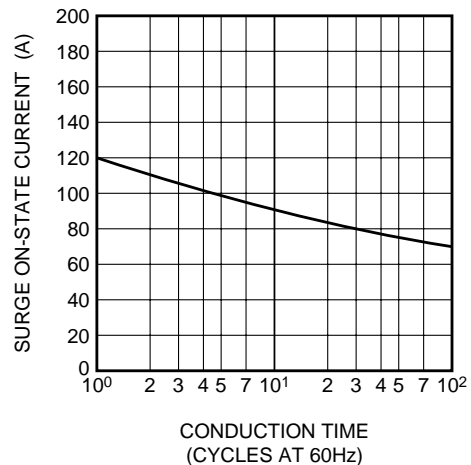

BCR12CM

MEDIUM POWER USE

NON-INSULATED TYPE, PLANAR PASSIVATION TYPE

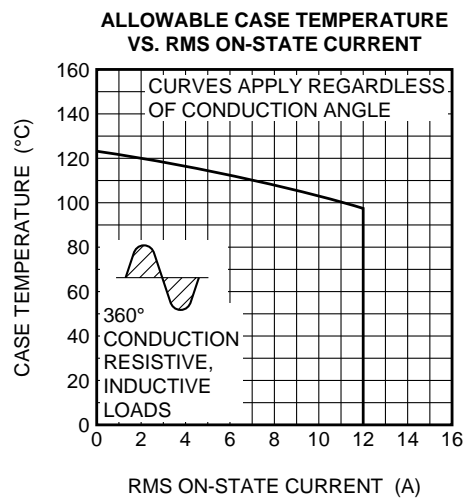
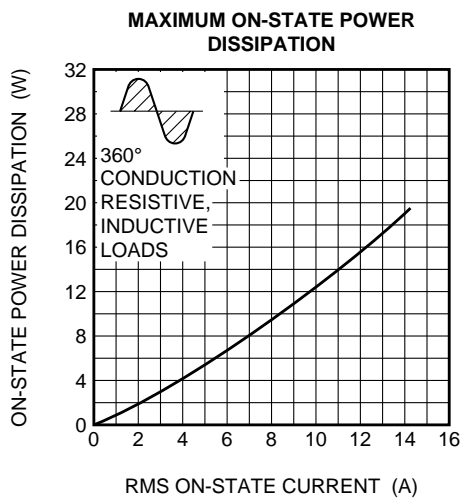
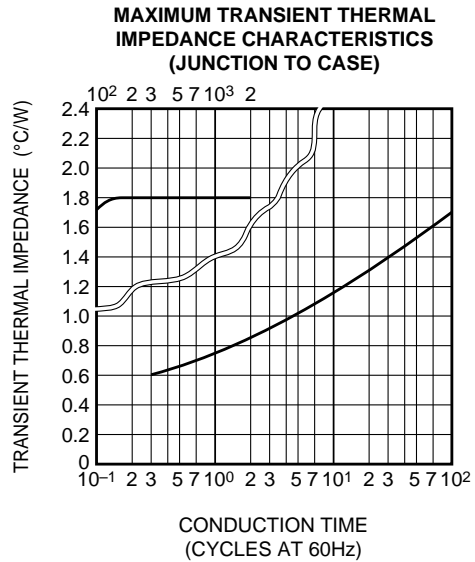
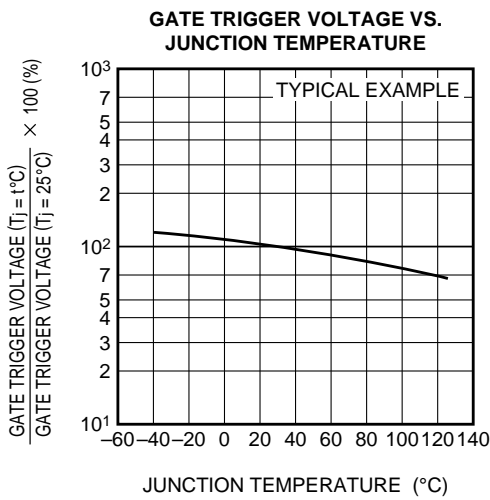
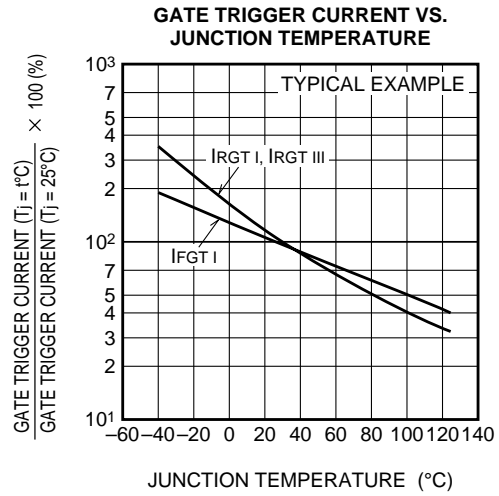
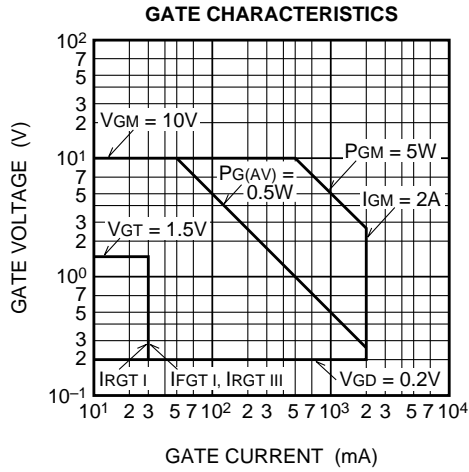

BCR12CM

MEDIUM POWER USE

NON-INSULATED TYPE, PLANAR PASSIVATION TYPE

ALLOWABLE AMBIENT TEMPERATURE VS. RMS ON-STATE CURRENT

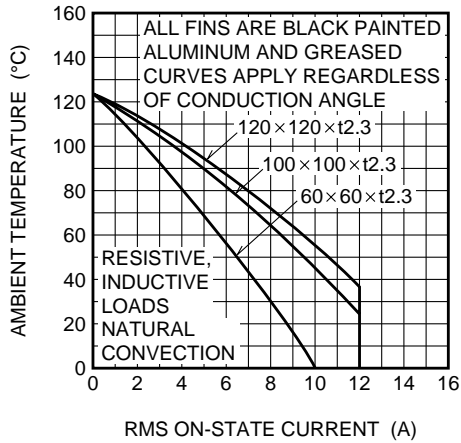

ALLOWABLE AMBIENT TEMPERATURE VS. RMS ON-STATE CURRENT

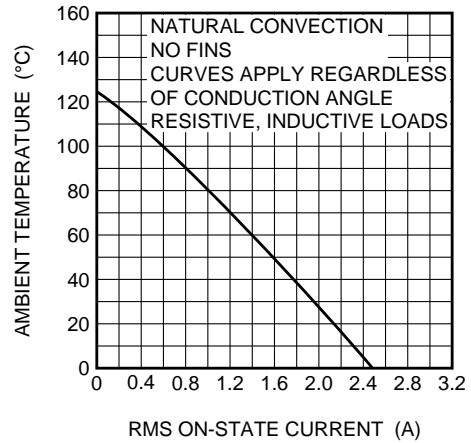

REPETITIVE PEAK OFF-STATE CURRENT VS. JUNCTION TEMPERATURE

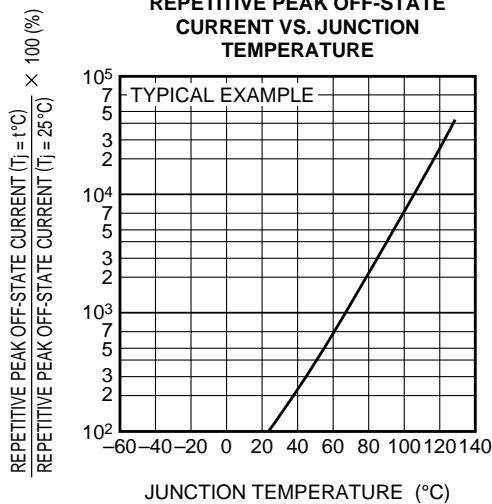

HOLDING CURRENT VS. JUNCTION TEMPERATURE

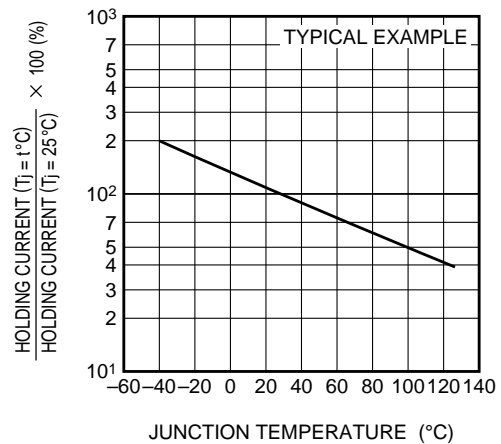

LATCHING CURRENT VS. JUNCTION TEMPERATURE

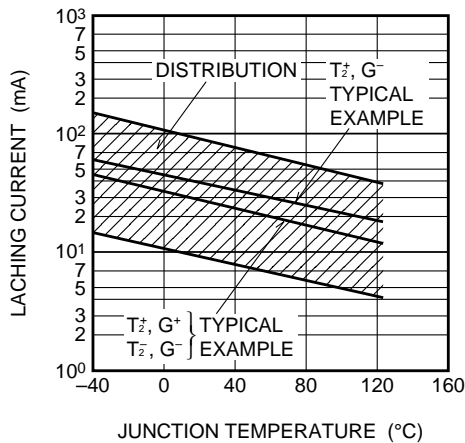

BREAKOVER VOLTAGE VS. JUNCTION TEMPERATURE

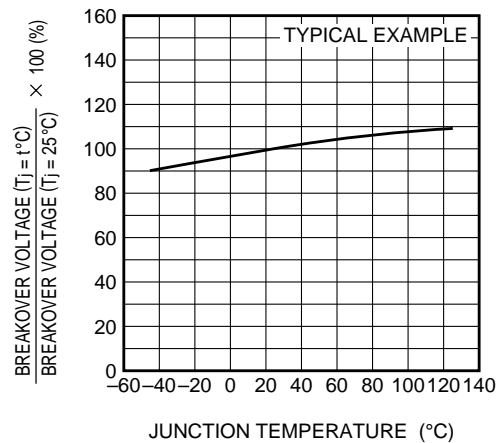

BCR12CM

MEDIUM POWER USE

NON-INSULATED TYPE, PLANAR PASSIVATION TYPE

BREAKOVER VOLTAGE VS. RATE OF RISE OF OFF-STATE VOLTAGE

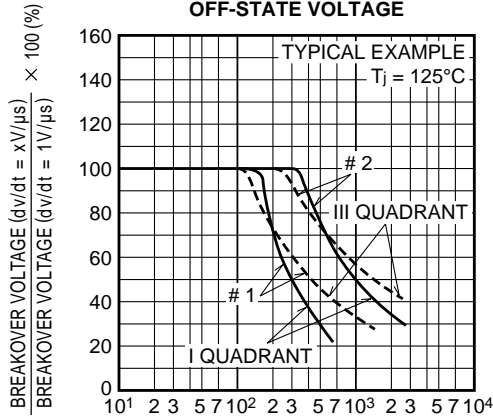

RATE OF RISE OF OFF-STATE VOLTAGE (V/μs)

COMMUTATION CHARACTERISTICS

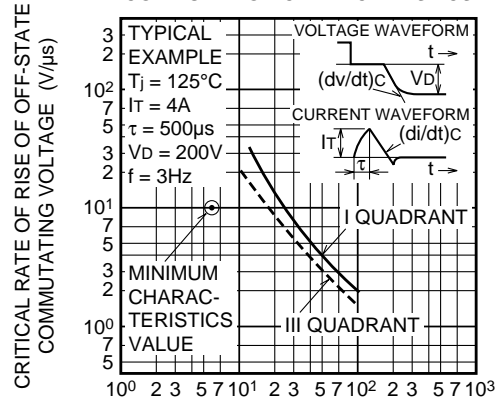

RATE OF DECAY OF ON-STATE COMMUTATING CURRENT (A/ms)

GATE TRIGGER CURRENT VS. GATE CURRENT PULSE WIDTH

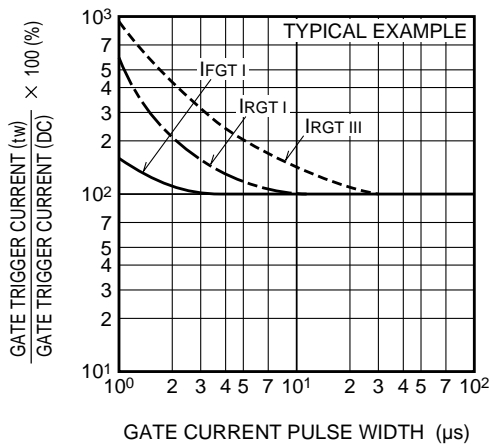

GATE CURRENT PULSE WIDTH (μs)

GATE TRIGGER CHARACTERISTICS TEST CIRCUITS

