

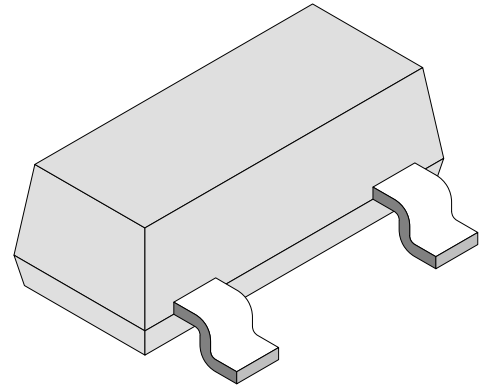

350 mW Surface Mount Zener Diodes

Features

- Planar die construction
- 350 mW Power dissipation
- Zener voltages from 2.7V – 51V
- Ideally suited for automated assembly processes



94 8550

Absolute Maximum Ratings

 $T_j = 25^\circ\text{C}$

Parameter	Test Conditions	Symbol	Value	Unit
Power dissipation	on ceramic substrate 10mm x 8mm x 0.7mm	P_d	350	mW
Zener current (see figures 1–3 below)				
Junction and storage temperature range		$T_j=T_{stg}$	-55...+150	$^\circ\text{C}$

Maximum Thermal Resistance

 $T_j = 25^\circ\text{C}$

Parameter	Test Conditions	Symbol	Value	Unit
Junction ambient	on ceramic substrate 10mm x 8mm x 0.7mm	R_{thJA}	420	K/W

Electrical Characteristics

 $T_j = 25^\circ\text{C}$

Parameter	Test Conditions	Type	Symbol	Min	Typ	Max	Unit
Forward Voltage	$I_F=10\text{ mA}$		V_F			0.9	V

Type	Marking	V _Z	Z _{ZT}	@ I _{ZT}	Z _{ZK}	@ I _{ZK}	T _C	I _R	@ V _R
BZX84C...		V	Ω	mA	Ω	mA	%/°C	μA	V
		@ I _{ZT}							
2V7	KZC	2.5 to 2.9	100	5.0	600	1.0	-0.065	20	1.0
3V0	KZD	2.8 to 3.2	100	5.0	600	1.0	-0.060	10	1.0
3V3	KZE	3.1 to 3.5	95	5.0	600	1.0	-0.055	5.0	1.0
3V6	KZF	3.4 to 3.8	95	5.0	600	1.0	-0.055	5.0	1.0
3V9	KZG	3.7 to 4.1	90	5.0	600	1.0	-0.050	3.0	1.0
4V3	KZH	4.0 to 4.6	90	5.0	600	1.0	-0.035	3.0	1.0
4V7	KZ1	4.4 to 5.0	80	5.0	500	1.0	-0.015	4.0	2.0
5V1	KZ2	4.8 to 5.4	60	5.0	480	1.0	+0.005	2.0	2.0
5V6	KZ3	5.2 to 6.0	40	5.0	400	1.0	+0.020	1.0	2.0
6V2	KZ4	5.8 to 6.6	10	5.0	150	1.0	+0.030	3.0	4.0
6V8	KZ5	6.4 to 7.2	15	5.0	80	1.0	+0.045	2.0	4.0
7V5	KZ6	7.0 to 7.9	15	5.0	80	1.0	+0.050	1.0	5.0
8V2	KZ7	7.7 to 8.7	15	5.0	80	1.0	+0.055	0.7	5.0
9V1	KZ8	8.5 to 9.6	15	5.0	100	1.0	+0.065	0.5	6.0
10	KZ9	9.4 to 10.6	20	5.0	150	1.0	+0.065	0.2	7.0
11	KY1	10.4 to 11.6	20	5.0	150	1.0	+0.070	0.1	8.0
12	KY2	11.4 to 12.7	25	5.0	150	1.0	+0.075	0.1	8.0
13	KY3	12.4 to 14.1	30	5.0	170	1.0	+0.080	0.1	8.0
15	KY4	13.8 to 15.6	30	5.0	200	1.0	+0.080	0.05	0.7V _{Znom}
16	KY5	15.3 to 17.1	40	5.0	200	1.0	+0.090	0.05	0.7V _{Znom}
18	KY6	16.8 to 19.1	45	5.0	225	1.0	+0.090	0.05	0.7V _{Znom}
20	KY7	18.8 to 21.2	55	5.0	225	1.0	+0.090	0.05	0.7V _{Znom}
22	KY8	20.8 to 23.3	55	5.0	250	1.0	+0.090	0.05	0.7V _{Znom}
24	KY9	22.8 to 25.6	70	5.0	250	1.0	+0.090	0.05	0.7V _{Znom}
27	KYA	25.1 to 28.9	80	2.0	300	0.5	+0.090	0.05	0.7V _{Znom}
30	KYB	28 to 32	80	2.0	300	0.5	+0.090	0.05	0.7V _{Znom}
33	KYC	31 to 35	80	2.0	325	0.5	+0.090	0.05	0.7V _{Znom}
36	KYD	34 to 38	90	2.0	350	0.5	+0.090	0.05	0.7V _{Znom}
39	KYE	37 to 41	130	2.0	350	0.5	+0.110	0.05	0.7V _{Znom}
43	KYF	40 to 46	150	2.0	375	0.5	+0.110	0.05	0.7V _{Znom}
47	KYG	44 to 50	170	2.0	375	0.5	+0.110	0.05	0.7V _{Znom}
51	KYH	48 to 54	180	2.0	400	0.5	+0.110	0.05	0.7V _{Znom}

1) Device mounted on ceramic substrate 8mmx10mmx0.7mm

2) V_Z measured at I_{ZT} using a pulse test. I_Z pulse width = 5 ms. Standard voltage tolerance is 5%.

Characteristics ($T_j = 25^\circ\text{C}$ unless otherwise specified)

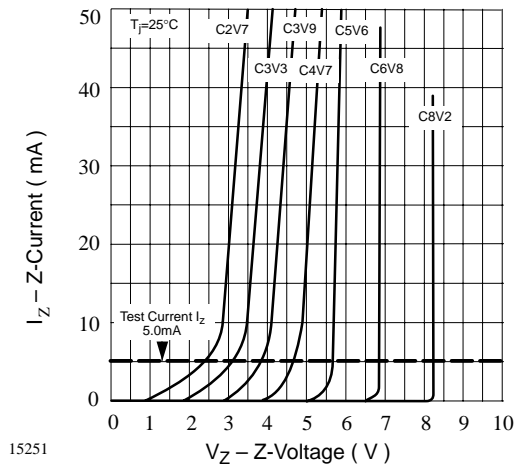

Figure 1. Z-Current vs. Z-Voltage

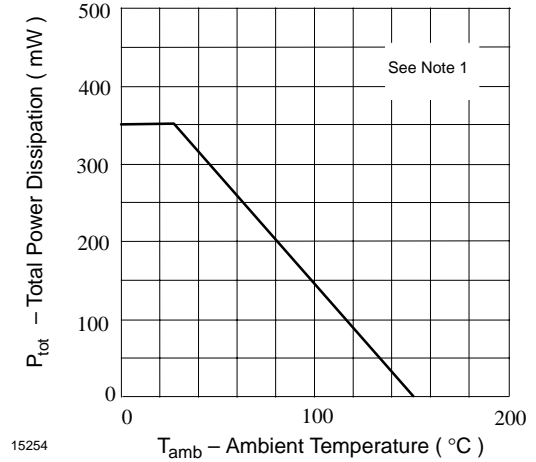

Figure 4. Total Power Dissipation vs. Ambient Temperature

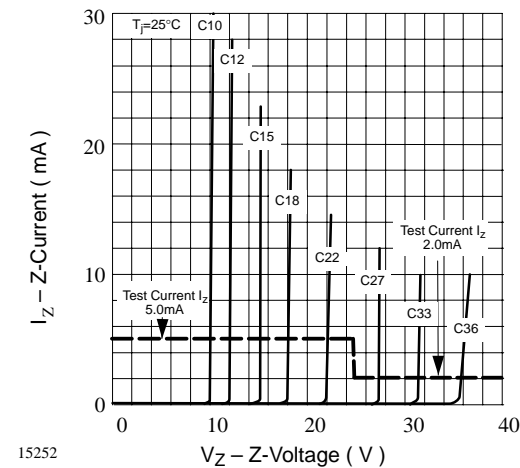

Figure 2. Z-Current vs. Z-Voltage

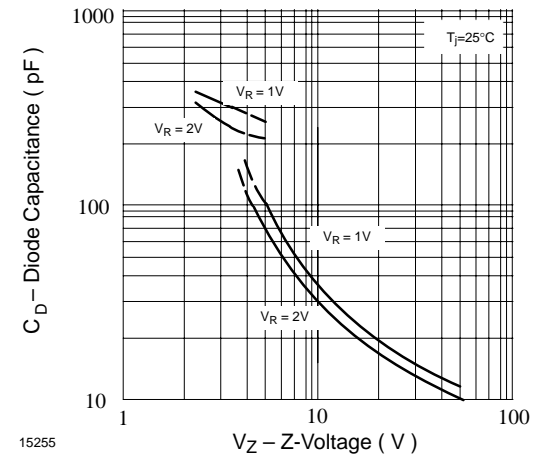

Figure 5. Diode Capacitance vs. Z-Voltage

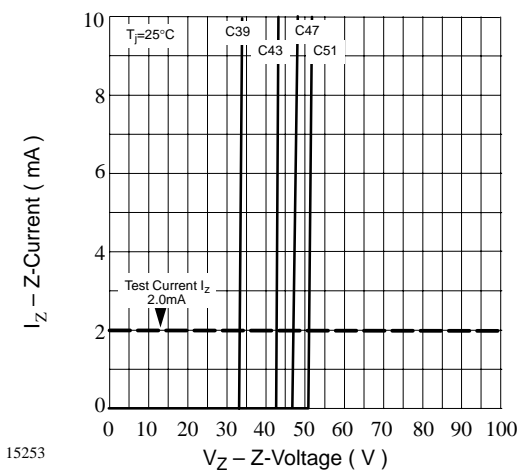

Figure 3. Z-Current vs. Z-Voltage

BZX84C2V7-BZX84C51



Vishay Telefunken

Dimensions in mm

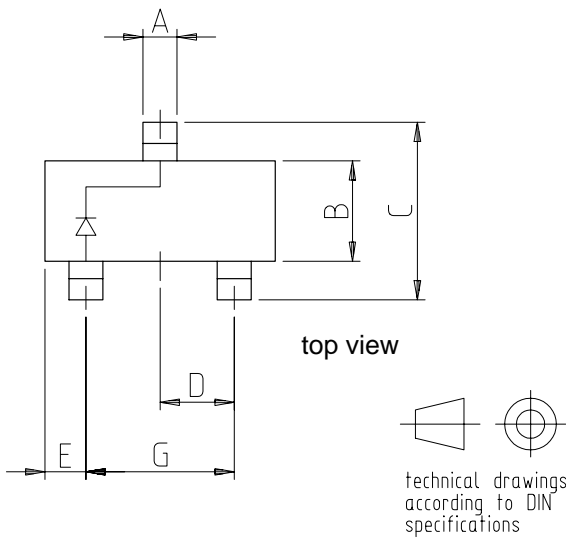
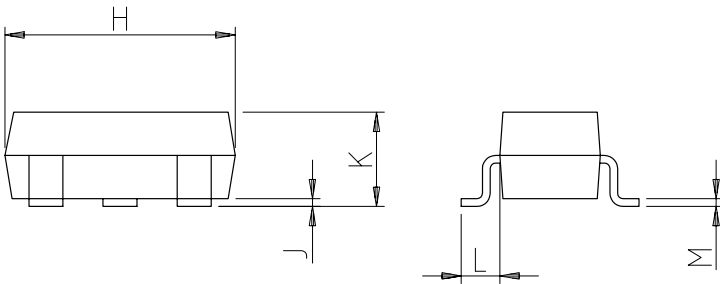

SOT-23		
Dim	Min	Max
A	0.37	0.50
B	1.19	1.40
C	2.10	2.50
D	0.89	1.05
E	0.45	0.61
G	1.78	2.05
H	2.79	3.05
J	0.013	0.15
K	0.89	1.10
L	0.45	0.61
M	0.076	0.130
All Dimensions in mm		

14370

Case: SOT23, molded plastic
 Mounting position: any
 Approx. weight: 0.008 grams



Ozone Depleting Substances Policy Statement

It is the policy of **Vishay Semiconductor GmbH** to

1. Meet all present and future national and international statutory requirements.
2. Regularly and continuously improve the performance of our products, processes, distribution and operating systems
with respect to their impact on the health and safety of our employees and the public, as well as their impact on the environment.

It is particular concern to control or eliminate releases of those substances into the atmosphere which are known as ozone depleting substances (ODSs).

The Montreal Protocol (1987) and its London Amendments (1990) intend to severely restrict the use of ODSs and forbid their use within the next ten years. Various national and international initiatives are pressing for an earlier ban on these substances.

Vishay Semiconductor GmbH has been able to use its policy of continuous improvements to eliminate the use of ODSs listed in the following documents.

1. Annex A, B and list of transitional substances of the Montreal Protocol and the London Amendments respectively
2. Class I and II ozone depleting substances in the Clean Air Act Amendments of 1990 by the Environmental Protection Agency (EPA) in the USA
3. Council Decision 88/540/EEC and 91/690/EEC Annex A, B and C (transitional substances) respectively.

Vishay Semiconductor GmbH can certify that our semiconductors are not manufactured with ozone depleting substances and do not contain such substances.

We reserve the right to make changes to improve technical design and may do so without further notice.

Parameters can vary in different applications. All operating parameters must be validated for each customer application by the customer. Should the buyer use Vishay-Telefunken products for any unintended or unauthorized application, the buyer shall indemnify Vishay-Telefunken against all claims, costs, damages, and expenses, arising out of, directly or indirectly, any claim of personal damage, injury or death associated with such unintended or unauthorized use.

Vishay Semiconductor GmbH, P.O.B. 3535, D-74025 Heilbronn, Germany
Telephone: 49 (0) 7131 67 2831, Fax number: 49 (0) 7131 67 2423