

IGBT MODULE (Single-in-Line)

■ Features

- Square RBSOA
- Low Saturation Voltage
- Improved FWD Characteristic
- Minimized Internal Stray Inductance

■ Applications

- High Power Switching
- A.C. Motor Controls
- D.C. Motor Controls

■ Outline Drawing

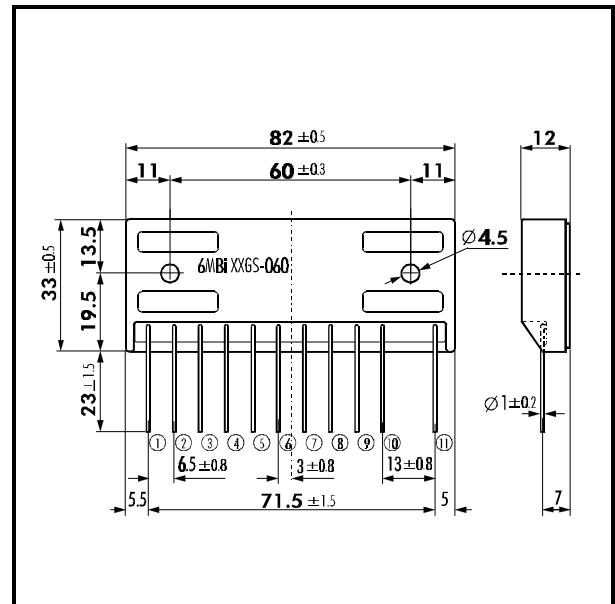

■ Maximum Ratings and Characteristics

• Absolute Maximum Ratings (T_c=25°C)

Items	Symbols	Ratings	Units
Collector-Emitter Voltage	V _{CEs}	600	V
Gate -Emitter Voltage	V _{GES}	± 20	V
Collector Current	Continuous	I _C	10
	1ms	I _{C PULSE}	20
	Continuous	-I _C	10
	1ms	-I _{C PULSE}	20
Max. Power Dissipation	P _C	45	W
Operating Temperature	T _i	+150	°C
Storage Temperature	T _{stg}	-40 ~ +125	°C
Isolation Voltage	V _{is}	2000	V
Screw Torque	Mounting *1	1.7	Nm

Note: *1:Recommendable Value; 1.3 ~ 1.7 Nm (M4)

■ Equivalent Circuit

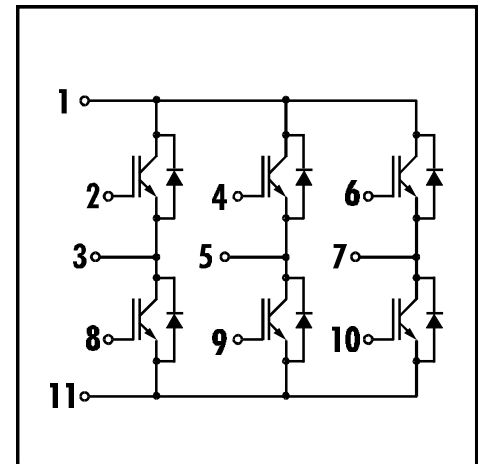

• Electrical Characteristics (at T_j=25°C)

Items	Symbols	Test Conditions	Min.	Typ.	Max.	Units
Zero Gate Voltage Collector Current	I _{CES}	V _{GE} =0V V _{CE} =600V			1.0	mA
Gate-Emitter Leakage Current	I _{GES}	V _{CE} =0V V _{GE} =± 20V			100	nA
Gate-Emitter Threshold Voltage	V _{GE(th)}	V _{GE} =20V I _C =10mA	5.5		8.5	V
Collector-Emitter Saturation Voltage	V _{CE(sat)}	V _{GE} =15V I _C =10A			2.8	V
Input capacitance	C _{ies}	V _{GE} =0V		650		pF
Output capacitance	C _{oes}	V _{CE} =10V		150		
Reverse Transfer capacitance	C _{res}	f=1MHz		36		
Turn-on Time	t _{ON}	V _{CC} =300V			1.2	μs
	t _r	I _C =10A			1.0	
Turn-off Time	t _{OFF}	V _{GE} =± 15V			1.0	
	t _f	R _G =220Ω			0.35	
Diode Forward On-Voltage	V _F	I _F =10A V _{GE} =0V			3.0	V
Reverse Recovery Time	t _{rr}	I _F =10A			300	ns

• Thermal Characteristics

Items	Symbols	Test Conditions	Min.	Typ.	Max.	Units
Thermal Resistance	R _{th(f-c)}	IGBT			2.78	°C/W
	R _{th(f-e)}	Diode			4.50	
	R _{th(c-f)}	With Thermal Compound		0.06		

Collector-Emitter voltage vs. Collector current
 $T_j=25^\circ\text{C}$

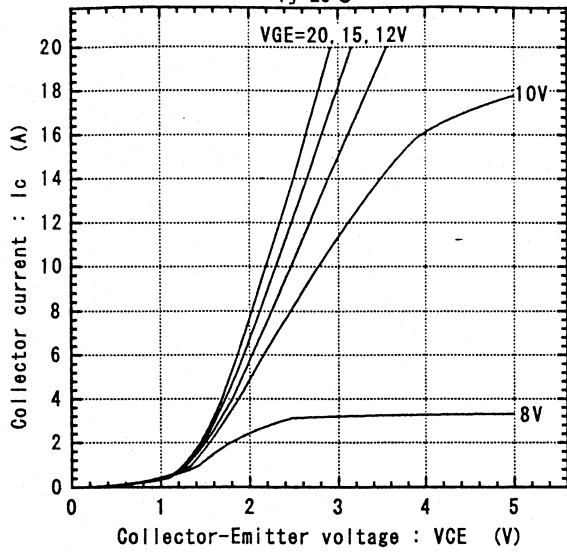

Collector-Emitter voltage vs. Collector current
 $T_j=125^\circ\text{C}$

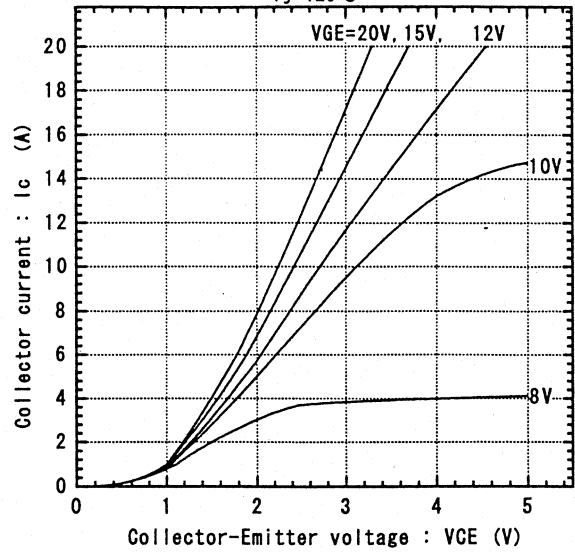

Collector-Emitter vs. Gate-Emitter voltage
 $T_j=25^\circ\text{C}$

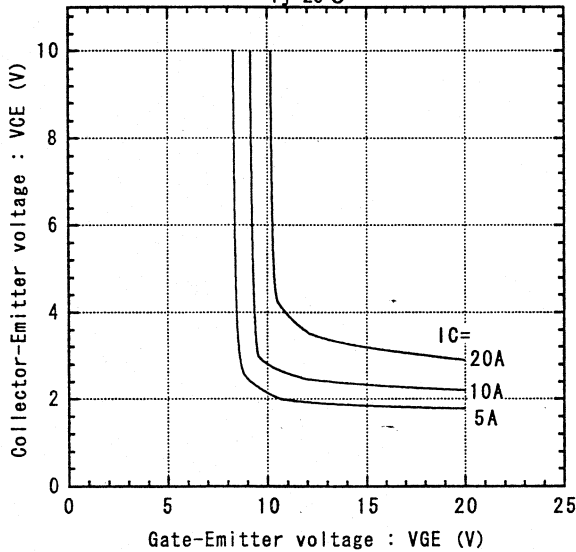

Collector-Emitter vs. Gate-Emitter voltage
 $T_j=125^\circ\text{C}$

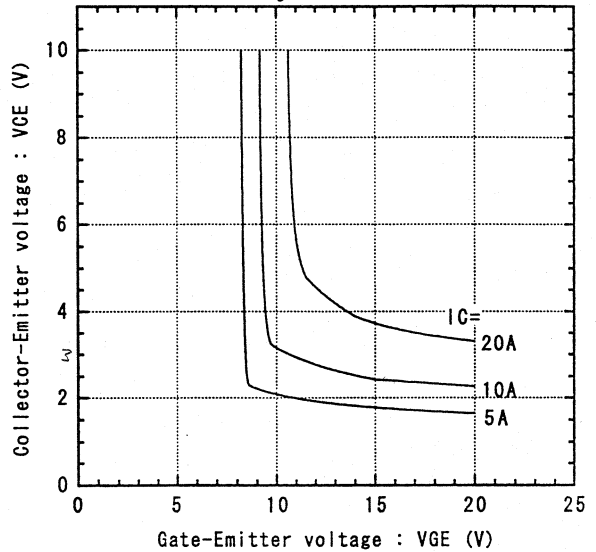

Switching time vs. Collector current
 $V_{cc}=300\text{V}$, $R_G=220\Omega$, $V_{GE}=\pm 15\text{V}$, $T_j=25^\circ\text{C}$

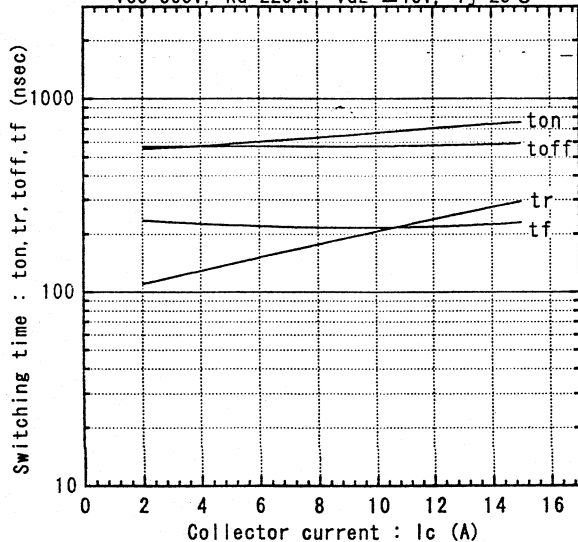

Switching time vs. Collector current
 $V_{cc}=300\text{V}$, $R_G=220\Omega$, $V_{GE}=\pm 15\text{V}$, $T_j=125^\circ\text{C}$

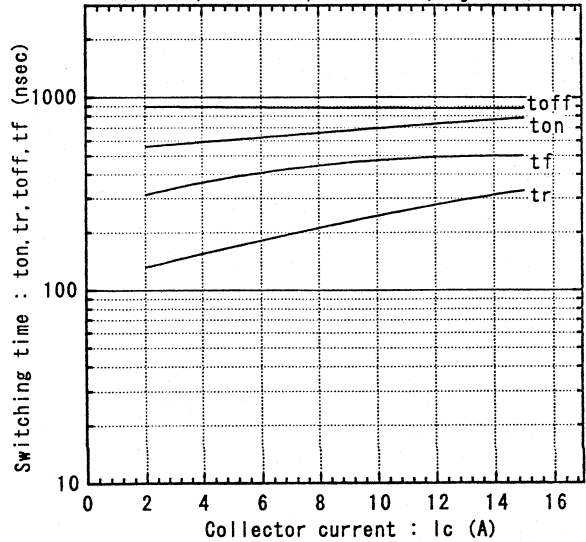

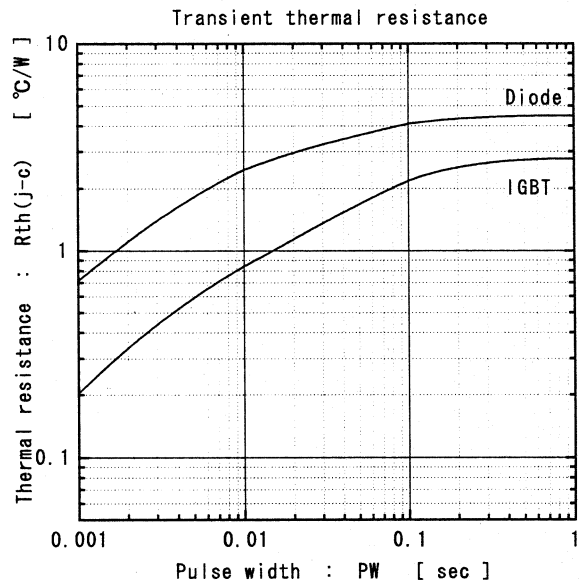
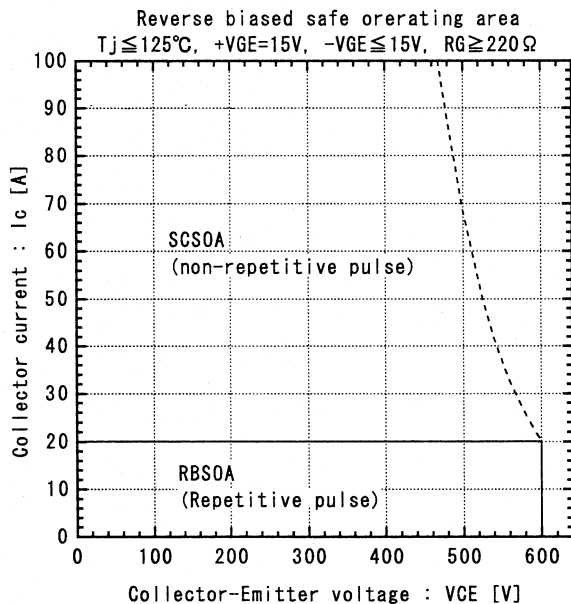
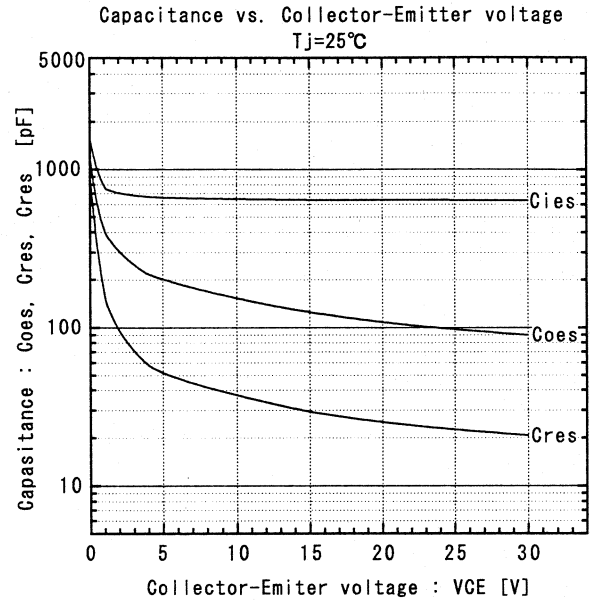
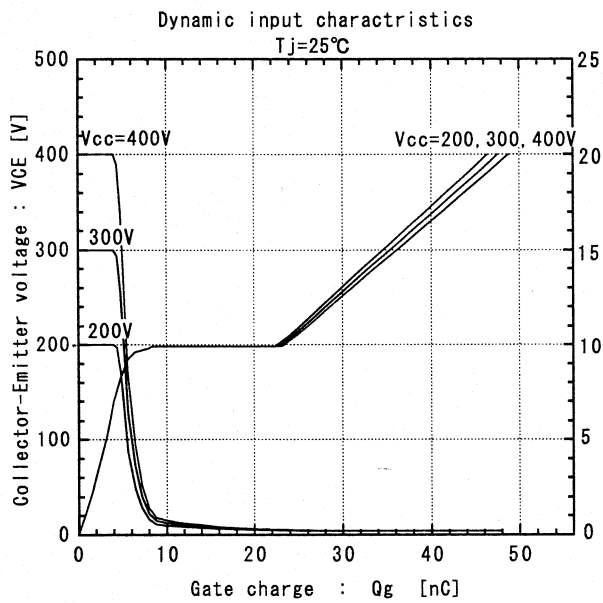
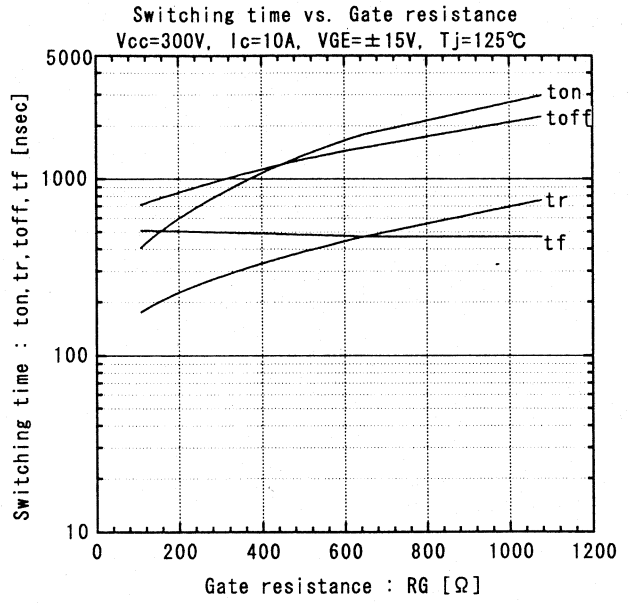
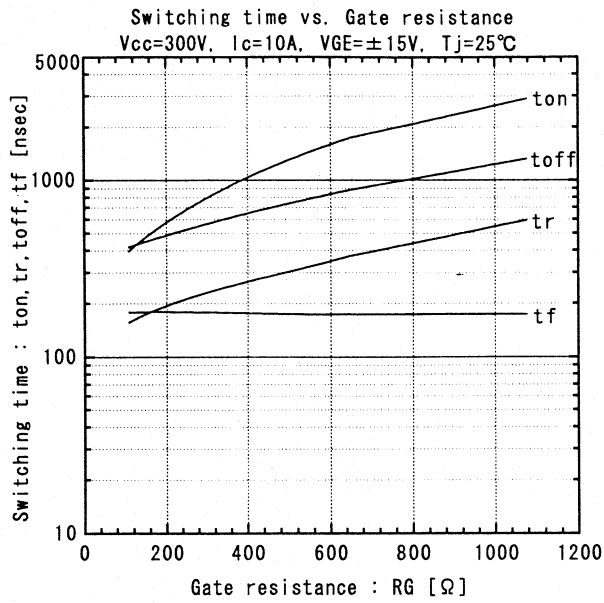

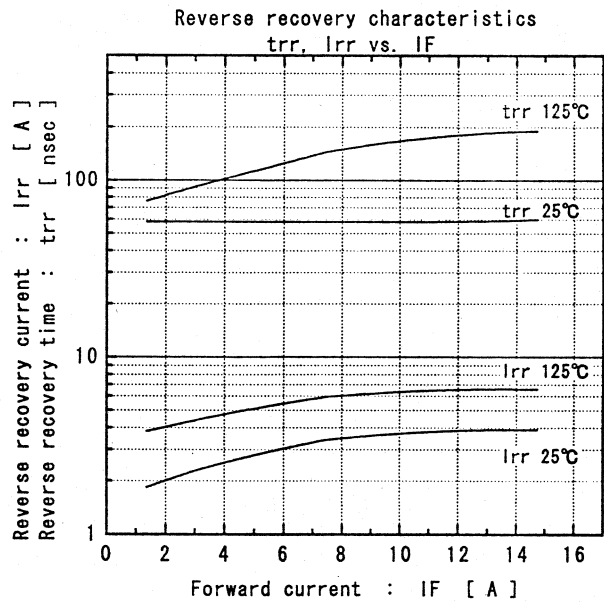
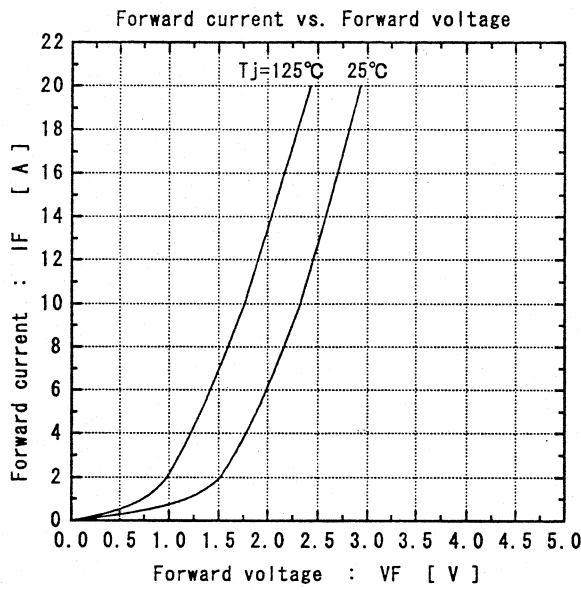
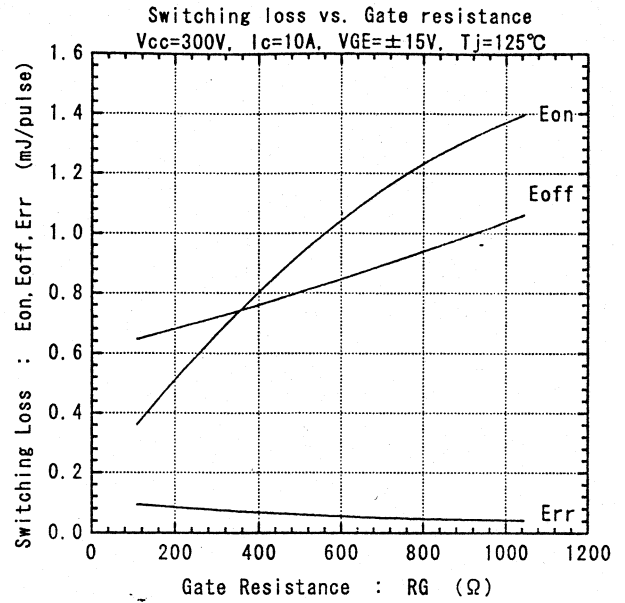
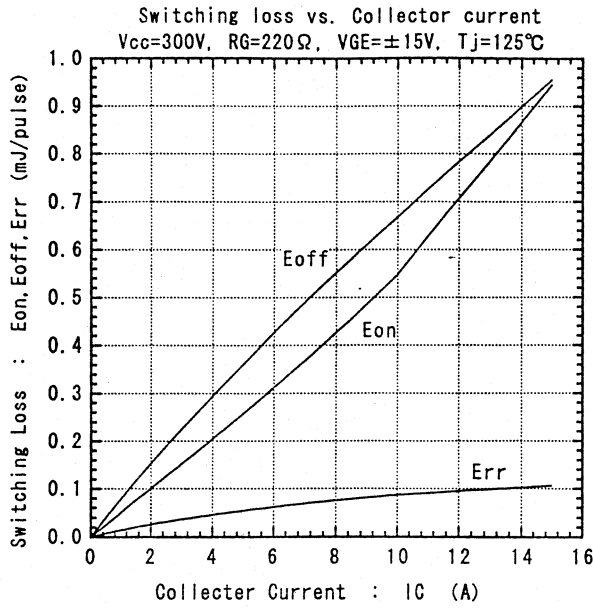

Fuji Electric GmbH

Lyoner Straße 26

D-60528 Frankfurt/M

Tel.: 069 - 66 90 29 - 0

Fax.: 069 - 66 90 29 - 56

Fuji Electric (UK) Ltd.

Commonwealth House
2 Chalkhill Road Hammersmith

London W6 8DW, UK

Tel.: 0181 - 233 11 30

Fax.: 0181 - 233 11 60