



Is Now Part of



ON Semiconductor®

To learn more about ON Semiconductor, please visit our website at
www.onsemi.com

ON Semiconductor and the ON Semiconductor logo are trademarks of Semiconductor Components Industries, LLC dba ON Semiconductor or its subsidiaries in the United States and/or other countries. ON Semiconductor owns the rights to a number of patents, trademarks, copyrights, trade secrets, and other intellectual property. A listing of ON Semiconductor's product/patent coverage may be accessed at www.onsemi.com/site/pdf/Patent-Marking.pdf. ON Semiconductor reserves the right to make changes without further notice to any products herein. ON Semiconductor makes no warranty, representation or guarantee regarding the suitability of its products for any particular purpose, nor does ON Semiconductor assume any liability arising out of the application or use of any product or circuit, and specifically disclaims any and all liability, including without limitation special, consequential or incidental damages. Buyer is responsible for its products and applications using ON Semiconductor products, including compliance with all laws, regulations and safety requirements or standards, regardless of any support or applications information provided by ON Semiconductor. "Typical" parameters which may be provided in ON Semiconductor data sheets and/or specifications can and do vary in different applications and actual performance may vary over time. All operating parameters, including "Typicals" must be validated for each customer application by customer's technical experts. ON Semiconductor does not convey any license under its patent rights nor the rights of others. ON Semiconductor products are not designed, intended, or authorized for use as a critical component in life support systems or any FDA Class 3 medical devices or medical devices with a same or similar classification in a foreign jurisdiction or any devices intended for implantation in the human body. Should Buyer purchase or use ON Semiconductor products for any such unintended or unauthorized application, Buyer shall indemnify and hold ON Semiconductor and its officers, employees, subsidiaries, affiliates, and distributors harmless against all claims, costs, damages, and expenses, and reasonable attorney fees arising out of, directly or indirectly, any claim of personal injury or death associated with such unintended or unauthorized use, even if such claim alleges that ON Semiconductor was negligent regarding the design or manufacture of the part. ON Semiconductor is an Equal Opportunity/Affirmative Action Employer. This literature is subject to all applicable copyright laws and is not for resale in any manner.



ISL9V5036S3S / ISL9V5036P3 / ISL9V5036S3

EcoSPARK® 500mJ, 360V, N-Channel Ignition IGBT

General Description

The ISL9V5036S3S, ISL9V5036P3, and ISL9V5036S3 are the next generation IGBTs that offer outstanding SCIS capability in the D²-Pak (TO-263) and TO-220 plastic package. These devices are intended for use in automotive ignition circuits, specifically as coil drivers. Internal diodes provide voltage clamping without the need for external components.

EcoSPARK® devices can be custom made to specific clamp voltages. Contact your nearest Fairchild sales office for more information.

Formerly Developmental Type 49443

Applications

- Automotive Ignition Coil Driver Circuits
- Coil-On Plug Applications

Features

- Industry Standard D²-Pak package
- SCIS Energy = 500mJ at T_J = 25°C
- Logic Level Gate Drive
- Qualified to AEC Q101
- RoHS Compliant



ISL9V5036S3S / ISL9V5036P3 / ISL9V5036S3

Package

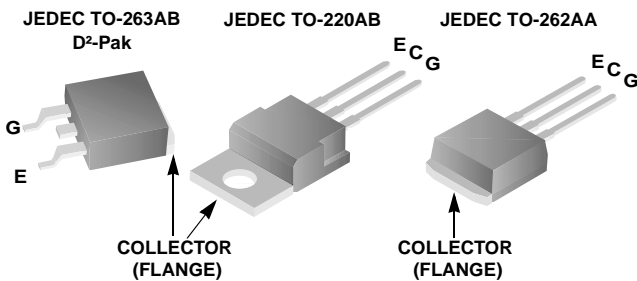

Symbol

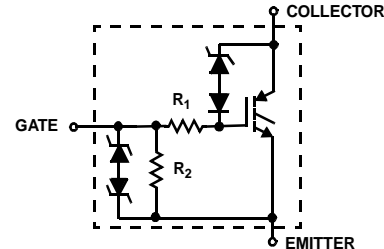

Device Maximum Ratings T_A = 25°C unless otherwise noted

| Symbol | Parameter | Ratings | Units |
|----------------------|---|------------|-------|
| BV _{CER} | Collector to Emitter Breakdown Voltage (I _C = 1 mA) | 390 | V |
| BV _{ECS} | Emitter to Collector Voltage - Reverse Battery Condition (I _C = 10 mA) | 24 | V |
| E _{SCIS25} | At Starting T _J = 25°C, I _{SCIS} = 38.5A, L = 670 μHy | 500 | mJ |
| E _{SCIS150} | At Starting T _J = 150°C, I _{SCIS} = 30A, L = 670 μHy | 300 | mJ |
| I _{C25} | Collector Current Continuous, At T _C = 25°C, See Fig 9 | 46 | A |
| I _{C110} | Collector Current Continuous, At T _C = 110°C, See Fig 9 | 31 | A |
| V _{GEM} | Gate to Emitter Voltage Continuous | ±10 | V |
| P _D | Power Dissipation Total T _C = 25°C | 250 | W |
| | Power Dissipation Derating T _C > 25°C | 1.67 | W/°C |
| T _J | Operating Junction Temperature Range | -40 to 175 | °C |
| T _{STG} | Storage Junction Temperature Range | -40 to 175 | °C |
| T _L | Max Lead Temp for Soldering (Leads at 1.6mm from Case for 10s) | 300 | °C |
| T _{pkg} | Max Lead Temp for Soldering (Package Body for 10s) | 260 | °C |
| ESD | Electrostatic Discharge Voltage at 100pF, 1500Ω | 4 | kV |

Package Marking and Ordering Information

| Device Marking | Device | Package | Reel Size | Tape Width | Quantity |
|----------------|---------------|----------|-----------|------------|----------|
| V5036S | ISL9V5036S3ST | TO-263AB | 330mm | 24mm | 800 |
| V5036P | ISL9V5036P3 | TO-220AA | Tube | N/A | 50 |
| V5036S | ISL9V5036S3 | TO-262AA | Tube | N/A | 50 |
| V5036S | ISL9V5036S3S | TO-263AB | Tube | N/A | 50 |

Electrical Characteristics $T_A = 25^\circ\text{C}$ unless otherwise noted

| Symbol | Parameter | Test Conditions | Min | Typ | Max | Units |
|--------|-----------|-----------------|-----|-----|-----|-------|
|--------|-----------|-----------------|-----|-----|-----|-------|

Off State Characteristics

| | | | | | | | |
|------------|--|--|---------------------------|----------|-----|----------|---------------|
| BV_{CER} | Collector to Emitter Breakdown Voltage | $I_C = 2\text{mA}$, $V_{GE} = 0$, $R_G = 1\text{K}\Omega$, See Fig. 15 $T_J = -40$ to 150°C | 330 | 360 | 390 | V | |
| BV_{CES} | Collector to Emitter Breakdown Voltage | $I_C = 10\text{mA}$, $V_{GE} = 0$, $R_G = 0$, See Fig. 15 $T_J = -40$ to 150°C | 360 | 390 | 420 | V | |
| BV_{ECS} | Emitter to Collector Breakdown Voltage | $I_C = -75\text{mA}$, $V_{GE} = 0\text{V}$, $T_C = 25^\circ\text{C}$ | 30 | - | - | V | |
| BV_{GES} | Gate to Emitter Breakdown Voltage | $I_{GES} = \pm 2\text{mA}$ | ± 12 | ± 14 | - | V | |
| I_{CER} | Collector to Emitter Leakage Current | $V_{CER} = 250\text{V}$, $R_G = 1\text{K}\Omega$, See Fig. 11 | $T_C = 25^\circ\text{C}$ | - | - | 25 | μA |
| | | | $T_C = 150^\circ\text{C}$ | - | - | 1 | mA |
| I_{ECS} | Emitter to Collector Leakage Current | $V_{EC} = 24\text{V}$, See Fig. 11 | $T_C = 25^\circ\text{C}$ | - | - | 1 | mA |
| | | | $T_C = 150^\circ\text{C}$ | - | - | 40 | mA |
| R_1 | Series Gate Resistance | | - | 75 | - | Ω | |
| R_2 | Gate to Emitter Resistance | | 10K | - | 30K | Ω | |

On State Characteristics

| | | | | | | | |
|---------------|---|--|--|---|------|------|---|
| $V_{CE(SAT)}$ | Collector to Emitter Saturation Voltage | $I_C = 10\text{A}$, $V_{GE} = 4.0\text{V}$ | $T_C = 25^\circ\text{C}$, See Fig. 4 | - | 1.17 | 1.60 | V |
| $V_{CE(SAT)}$ | Collector to Emitter Saturation Voltage | $I_C = 15\text{A}$, $V_{GE} = 4.5\text{V}$ | $T_C = 150^\circ\text{C}$ | - | 1.50 | 1.80 | V |

Dynamic Characteristics

| | | | | | | | |
|--------------|-----------------------------------|--|---------------------------|------|---|-----|---|
| $Q_{G(ON)}$ | Gate Charge | $I_C = 10\text{A}$, $V_{CE} = 12\text{V}$, $V_{GE} = 5\text{V}$, See Fig. 14 | - | 32 | - | nC | |
| $V_{GE(TH)}$ | Gate to Emitter Threshold Voltage | $I_C = 1.0\text{mA}$, $V_{CE} = V_{GE}$, See Fig. 10 | $T_C = 25^\circ\text{C}$ | 1.3 | - | 2.2 | V |
| | | | $T_C = 150^\circ\text{C}$ | 0.75 | - | 1.8 | V |
| V_{GEP} | Gate to Emitter Plateau Voltage | $I_C = 10\text{A}$, $V_{CE} = 12\text{V}$ | - | 3.0 | - | V | |

Switching Characteristics

| | | | | | | |
|---------------|---------------------------------------|---|---|------|-----|---------------|
| $t_{d(ON)R}$ | Current Turn-On Delay Time-Resistive | $V_{CE} = 14\text{V}$, $R_L = 1\Omega$, $V_{GE} = 5\text{V}$, $R_G = 1\text{K}\Omega$, $T_J = 25^\circ\text{C}$, See Fig. 12 | - | 0.7 | 4 | μs |
| t_{rR} | Current Rise Time-Resistive | | - | 2.1 | 7 | μs |
| $t_{d(OFF)L}$ | Current Turn-Off Delay Time-Inductive | $V_{CE} = 300\text{V}$, $L = 2\text{mH}$, $V_{GE} = 5\text{V}$, $R_G = 1\text{K}\Omega$, $T_J = 25^\circ\text{C}$, See Fig. 12 | - | 10.8 | 15 | μs |
| t_{fL} | Current Fall Time-Inductive | | - | 2.8 | 15 | μs |
| SCIS | Self Clamped Inductive Switching | $T_J = 25^\circ\text{C}$, $L = 670\mu\text{H}$, $R_G = 1\text{K}\Omega$, $V_{GE} = 5\text{V}$, See Fig. 1 & 2 | - | - | 500 | mJ |

Thermal Characteristics

| | | | | | | |
|-----------------|----------------------------------|------------------------|---|---|-----|--------------------|
| $R_{\theta JC}$ | Thermal Resistance Junction-Case | TO-263, TO-220, TO-262 | - | - | 0.6 | $^\circ\text{C/W}$ |
|-----------------|----------------------------------|------------------------|---|---|-----|--------------------|

Typical Characteristics

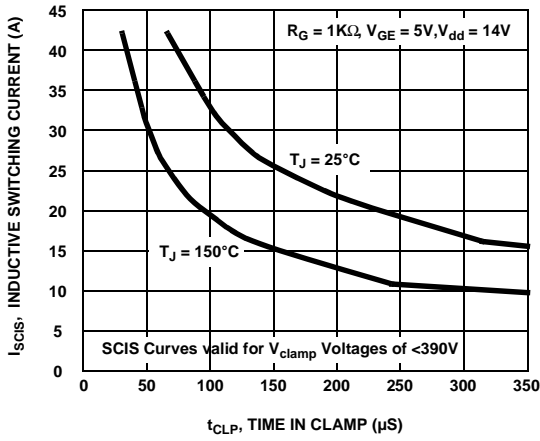

Figure 1. Self Clamped Inductive Switching Current vs Time in Clamp

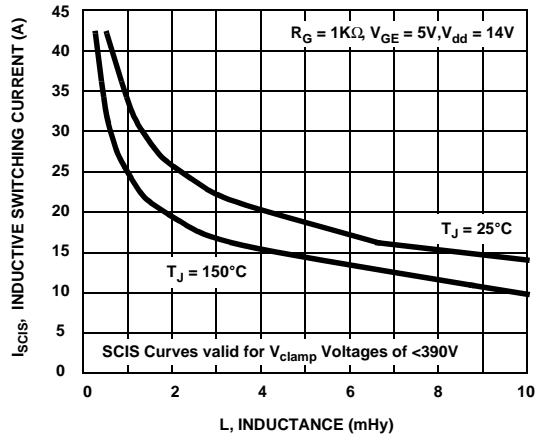

Figure 2. Self Clamped Inductive Switching Current vs Inductance

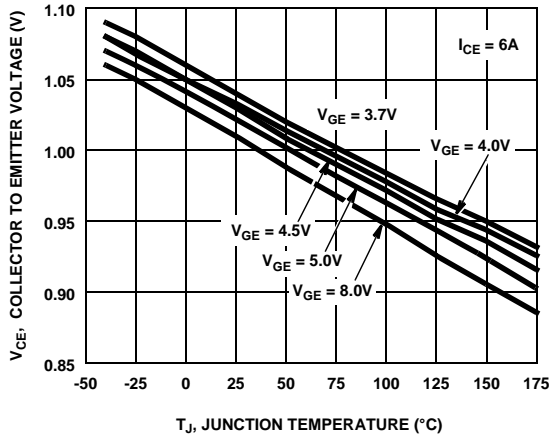

Figure 3. Collector to Emitter On-State Voltage vs Junction Temperature

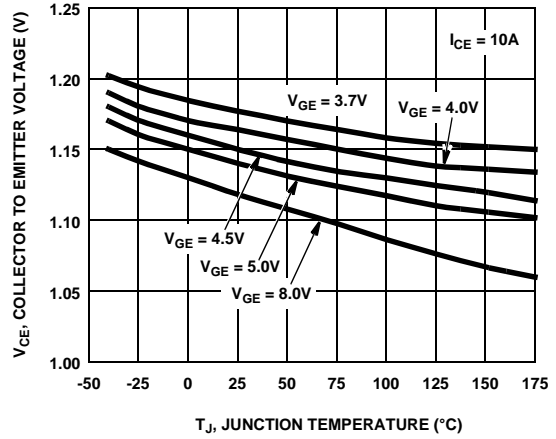

Figure 4. Collector to Emitter On-State Voltage vs Junction Temperature

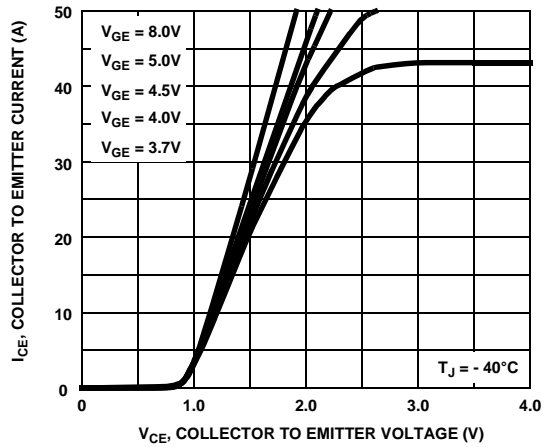

Figure 5. Collector Current vs Collector to Emitter On-State Voltage

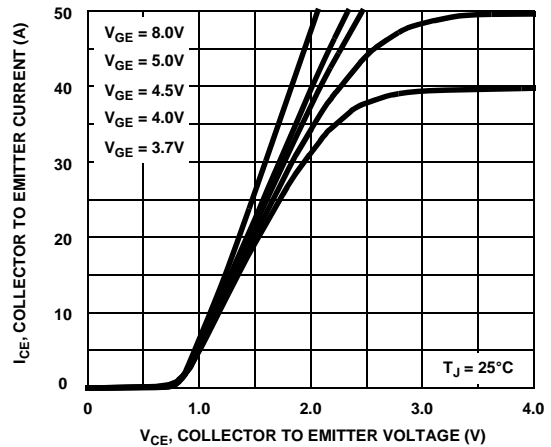

Figure 6. Collector Current vs Collector to Emitter On-State Voltage

Typical Characteristics (Continued)

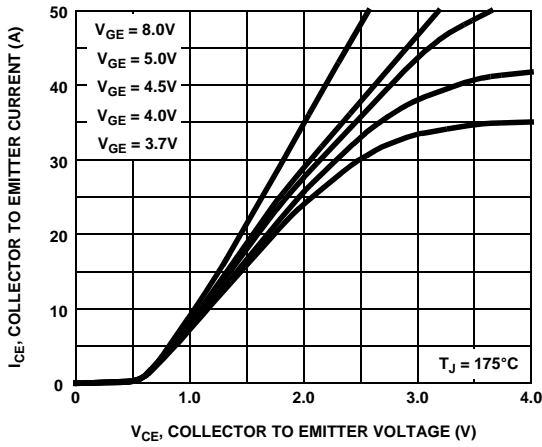

Figure 7. Collector to Emitter On-State Voltage vs Collector Current

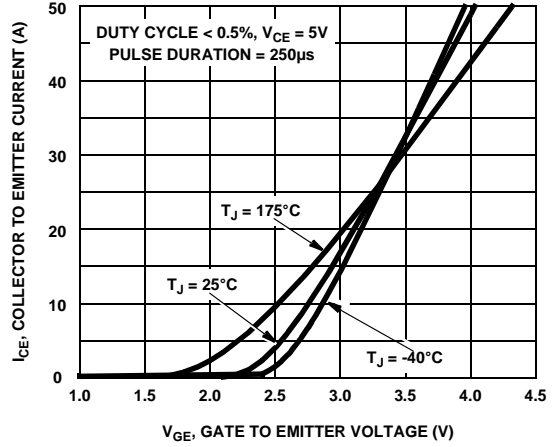

Figure 8. Transfer Characteristics

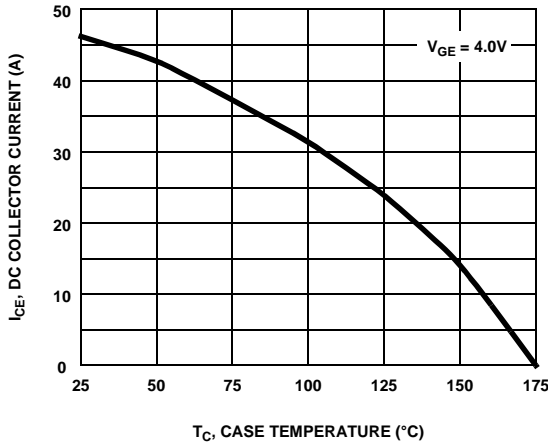

Figure 9. DC Collector Current vs Case Temperature

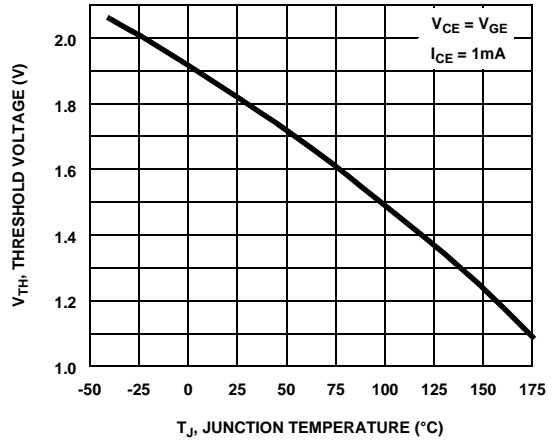

Figure 10. Threshold Voltage vs Junction Temperature

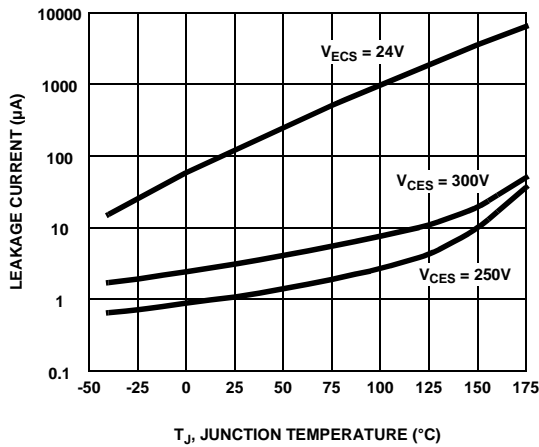

Figure 11. Leakage Current vs Junction Temperature

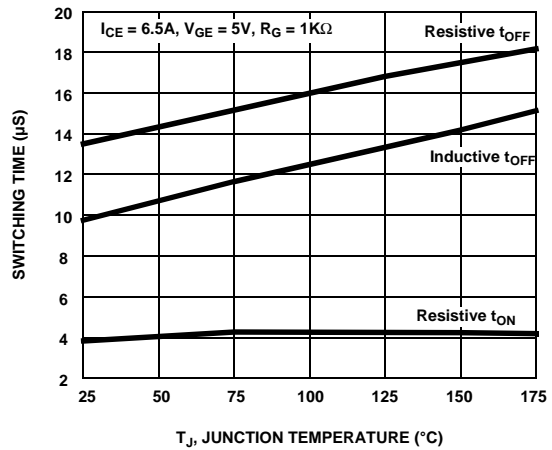

Figure 12. Switching Time vs Junction Temperature

Typical Characteristics (Continued)

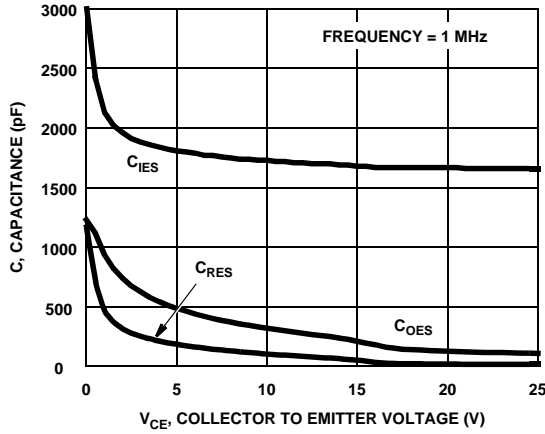

Figure 13. Capacitance vs Collector to Emitter Voltage

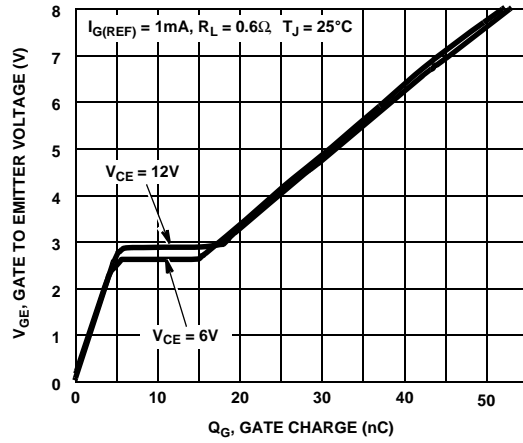

Figure 14. Gate Charge

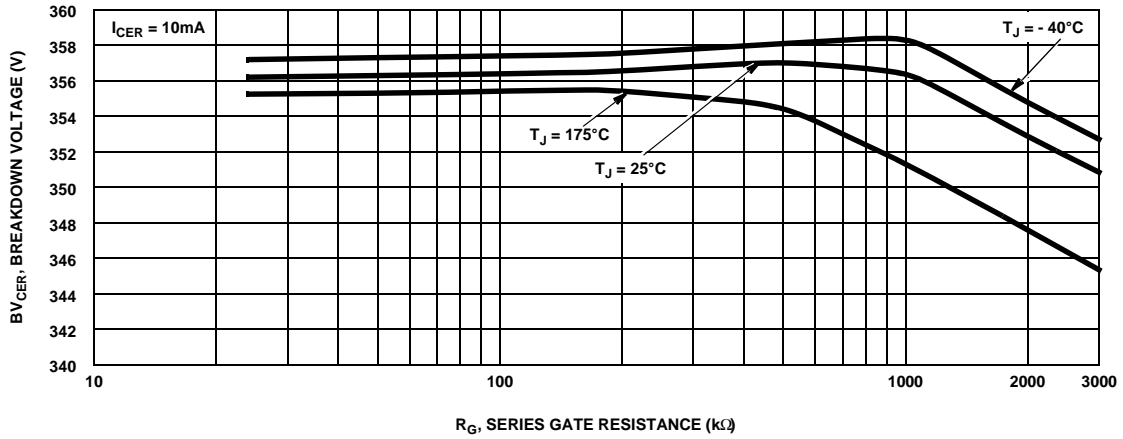

Figure 15. Breakdown Voltage vs Series Gate Resistance

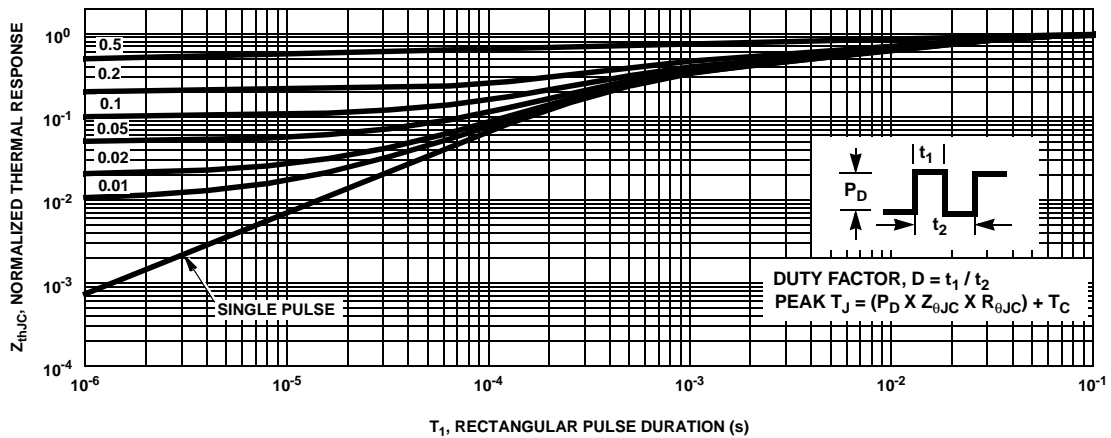

Figure 16. IGBT Normalized Transient Thermal Impedance, Junction to Case

Test Circuits and Waveforms

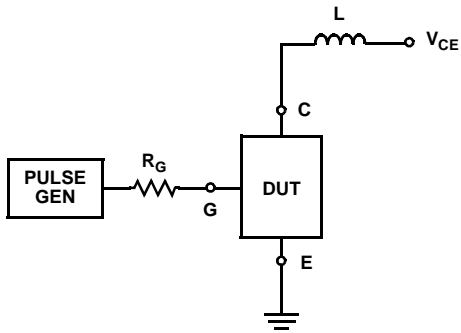

Figure 17. Inductive Switching Test Circuit

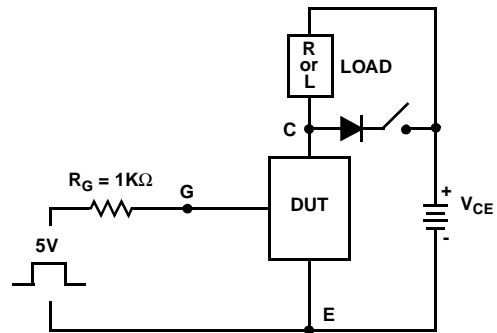

Figure 18. t_{ON} and t_{OFF} Switching Test Circuit

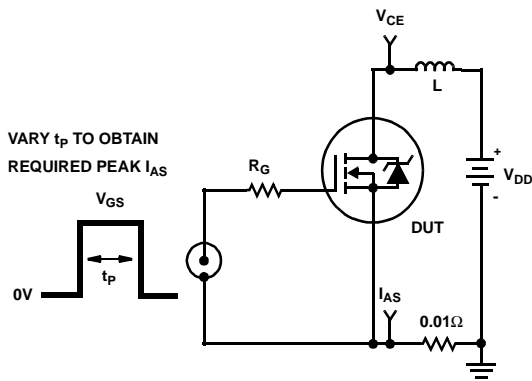

Figure 19. Energy Test Circuit

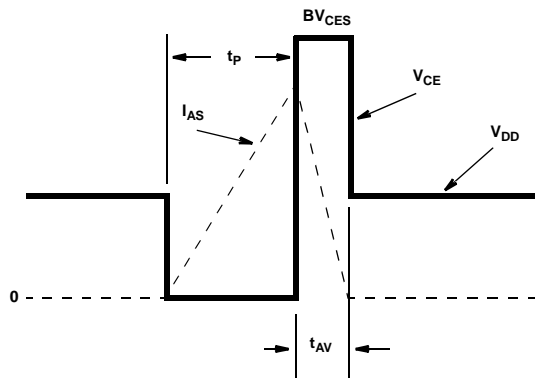

Figure 20. Energy Waveforms

SPICE Thermal Model

REV 1 May 2002

ISL9V5036S3S / ISL9V3536P3 / ISL9V5036S3

CTHERM1 th 6 4.0e2
 CTHERM2 6 5 3.6e-3
 CTHERM3 5 4 4.9e-2
 CTHERM4 4 3 3.2e-1
 CTHERM5 3 2 3.0e-1
 CTHERM6 2 tl 1.6e-2

RTHERM1 th 6 1.0e-2
 RTHERM2 6 5 1.4e-1
 RTHERM3 5 4 1.0e-1
 RTHERM4 4 3 9.0e-2
 RTHERM5 3 2 9.4e-2
 RTHERM6 2 tl 1.9e-2

SABER Thermal Model

SABER thermal model
 ISL9V5036S3S / ISL9V5036P3 / ISL9V5036S3
 template thermal_model th tl
 thermal_c th, tl

```
{
    ctherm.ctherm1 th 6 = 4.0e2
    ctherm.ctherm2 6 5 = 3.6e-3
    ctherm.ctherm3 5 4 = 4.9e-2
    ctherm.ctherm4 4 3 = 3.2e-1
    ctherm.ctherm5 3 2 = 3.0e-1
    ctherm.ctherm6 2 tl = 1.6e-2
```



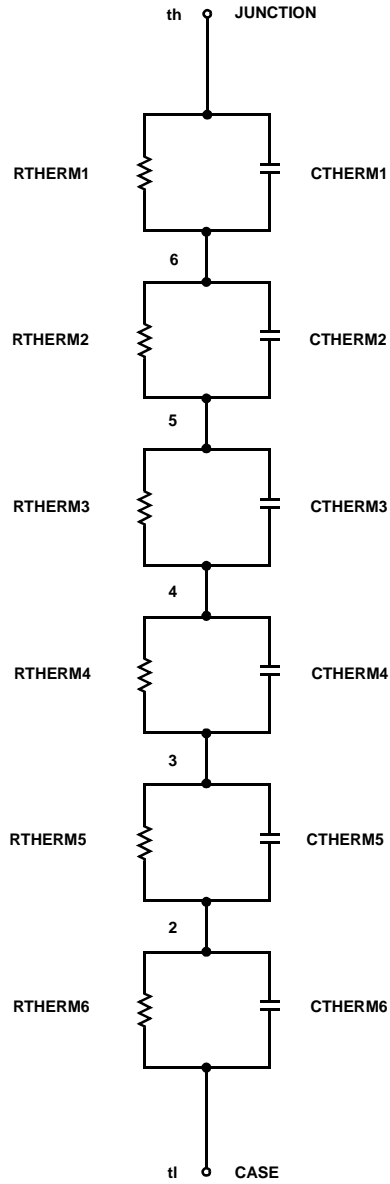



```
rtherm.rtherm1 th 6 = 1.0e-2
rtherm.rtherm2 6 5 = 1.4e-1
rtherm.rtherm3 5 4 = 1.0e-1
rtherm.rtherm4 4 3 = 9.0e-2
rtherm.rtherm5 3 2 = 9.4e-2
rtherm.rtherm6 2 tl = 1.9e-2
}
```





TRADEMARKS

The following includes registered and unregistered trademarks and service marks, owned by Fairchild Semiconductor and/or its global subsidiaries, and is not intended to be an exhaustive list of all such trademarks.

- | | | | |
|--|---|---|--|
| AccuPower™ | FlashWriter®* | Power-SPM™ |  SYSTEM GENERAL ®* The Power Franchise® the power franchise TinyBoost™ TinyBuck™ TinyCalc™ TinyLogic® TINYOPTO™ TinyPower™ TinyPWM™ TinyWire™ TriFault Detect™ TRUECURRENT™* μSerDes™  SerDes® UHC® Ultra FRFET™ UniFET™ VCX™ VisualMax™ XS™ |
| Auto-SPM™ | FPS™ | PowerTrench® | |
| Build it Now™ | F-PFS™ | PowerXS™ | |
| CorePLUS™ | FRFET® | Programmable Active Droop™ | |
| CorePOWER™ | Global Power Resource SM | QFET® | |
| CROSSVOLT™ | Green FPS™ | QS™ | |
| CTL™ | Green FPS™ e-Series™ | Quiet Series™ | |
| Current Transfer Logic™ | Gmax™ | RapidConfigure™ | |
| EcoSPARK® | GTO™ |  ™ | |
| EfficientMax™ | IntelliMAX™ | Saving our world, 1mW/W/kW at a time™ | |
| EZSWITCH™* | ISOPLANAR™ | SignalWise™ | |
|  ™* | MegaBuck™ | SmartMax™ | |
| DEUXPEED™ | MICROCOUPLER™ | SMART START™ | |
|  ™ | MicroFET™ | SPM® | |
| Fairchild® | MicroPak™ | STEALTH™ | |
| Fairchild Semiconductor® | MillerDrive™ | SuperFET™ | |
| FACT Quiet Series™ | MotionMax™ | SuperSOT™-3 | |
| FACT® | Motion-SPM™ | SuperSOT™-6 | |
| FAST® | OPTOLOGIC® | SuperSOT™-8 | |
| FAST® | OPTOPLANAR® | SupreMOS™ | |
| FastvCore™ |  ™ | SyncFET™ | |
| FETBench™ | PDP SPM™ | Sync-Lock™ | |

* Trademarks of System General Corporation, used under license by Fairchild Semiconductor.

DISCLAIMER

FAIRCHILD SEMICONDUCTOR RESERVES THE RIGHT TO MAKE CHANGES WITHOUT FURTHER NOTICE TO ANY PRODUCTS HEREIN TO IMPROVE RELIABILITY, FUNCTION, OR DESIGN. FAIRCHILD DOES NOT ASSUME ANY LIABILITY ARISING OUT OF THE APPLICATION OR USE OF ANY PRODUCT OR CIRCUIT DESCRIBED HEREIN; NEITHER DOES IT CONVEY ANY LICENSE UNDER ITS PATENT RIGHTS, NOR THE RIGHTS OF OTHERS. THESE SPECIFICATIONS DO NOT EXPAND THE TERMS OF FAIRCHILD'S WORLDWIDE TERMS AND CONDITIONS, SPECIFICALLY THE WARRANTY THEREIN, WHICH COVERS THESE PRODUCTS.

LIFE SUPPORT POLICY

FAIRCHILD'S PRODUCTS ARE NOT AUTHORIZED FOR USE AS CRITICAL COMPONENTS IN LIFE SUPPORT DEVICES OR SYSTEMS WITHOUT THE EXPRESS WRITTEN APPROVAL OF FAIRCHILD SEMICONDUCTOR CORPORATION.

As used herein:

- Life support devices or systems are devices or systems which, (a) are intended for surgical implant into the body or (b) support or sustain life, and (c) whose failure to perform when properly used in accordance with instructions for use provided in the labeling, can be reasonably expected to result in a significant injury of the user.
- A critical component in any component of a life support, device, or system whose failure to perform can be reasonably expected to cause the failure of the life support device or system, or to affect its safety or effectiveness.

ANTI-COUNTERFEITING POLICY

Fairchild Semiconductor Corporation's Anti-Counterfeiting Policy. Fairchild's Anti-Counterfeiting Policy is also stated on our external website, www.fairchildsemi.com, under Sales Support.

Counterfeiting of semiconductor parts is a growing problem in the industry. All manufacturers of semiconductor products are experiencing counterfeiting of their parts. Customers who inadvertently purchase counterfeit parts experience many problems such as loss of brand reputation, substandard performance, failed applications, and increased cost of production and manufacturing delays. Fairchild is taking strong measures to protect ourselves and our customers from the proliferation of counterfeit parts. Fairchild strongly encourages customers to purchase Fairchild parts either directly from Fairchild or from Authorized Fairchild Distributors who are listed by country on our web page cited above. Products customers buy either from Fairchild directly or from Authorized Fairchild Distributors are genuine parts, have full traceability, meet Fairchild's quality standards for handling and storage and provide access to Fairchild's full range of up-to-date technical and product information. Fairchild and our Authorized Distributors will stand behind all warranties and will appropriately address any warranty issues that may arise. Fairchild will not provide any warranty coverage or other assistance for parts bought from Unauthorized Sources. Fairchild is committed to combat this global problem and encourage our customers to do their part in stopping this practice by buying direct or from authorized distributors.

PRODUCT STATUS DEFINITIONS

Definition of Terms

| Datasheet Identification | Product Status | Definition |
|--------------------------|-----------------------|---|
| Advance Information | Formative / In Design | Datasheet contains the design specifications for product development. Specifications may change in any manner without notice. |
| Preliminary | First Production | Datasheet contains preliminary data; supplementary data will be published at a later date. Fairchild Semiconductor reserves the right to make changes at any time without notice to improve design. |
| No Identification Needed | Full Production | Datasheet contains final specifications. Fairchild Semiconductor reserves the right to make changes at any time without notice to improve the design. |
| Obsolete | Not In Production | Datasheet contains specifications on a product that is discontinued by Fairchild Semiconductor. The datasheet is for reference information only. |

ON Semiconductor and  are trademarks of Semiconductor Components Industries, LLC dba ON Semiconductor or its subsidiaries in the United States and/or other countries. ON Semiconductor owns the rights to a number of patents, trademarks, copyrights, trade secrets, and other intellectual property. A listing of ON Semiconductor's product/patent coverage may be accessed at www.onsemi.com/site/pdf/Patent-Marking.pdf. ON Semiconductor reserves the right to make changes without further notice to any products herein. ON Semiconductor makes no warranty, representation or guarantee regarding the suitability of its products for any particular purpose, nor does ON Semiconductor assume any liability arising out of the application or use of any product or circuit, and specifically disclaims any and all liability, including without limitation special, consequential or incidental damages. Buyer is responsible for its products and applications using ON Semiconductor products, including compliance with all laws, regulations and safety requirements or standards, regardless of any support or applications information provided by ON Semiconductor. "Typical" parameters which may be provided in ON Semiconductor data sheets and/or specifications can and do vary in different applications and actual performance may vary over time. All operating parameters, including "Typicals" must be validated for each customer application by customer's technical experts. ON Semiconductor does not convey any license under its patent rights nor the rights of others. ON Semiconductor products are not designed, intended, or authorized for use as a critical component in life support systems or any FDA Class 3 medical devices or medical devices with a same or similar classification in a foreign jurisdiction or any devices intended for implantation in the human body. Should Buyer purchase or use ON Semiconductor products for any such unintended or unauthorized application, Buyer shall indemnify and hold ON Semiconductor and its officers, employees, subsidiaries, affiliates, and distributors harmless against all claims, costs, damages, and expenses, and reasonable attorney fees arising out of, directly or indirectly, any claim of personal injury or death associated with such unintended or unauthorized use, even if such claim alleges that ON Semiconductor was negligent regarding the design or manufacture of the part. ON Semiconductor is an Equal Opportunity/Affirmative Action Employer. This literature is subject to all applicable copyright laws and is not for resale in any manner.

PUBLICATION ORDERING INFORMATION

LITERATURE FULFILLMENT:

Literature Distribution Center for ON Semiconductor
19521 E. 32nd Pkwy, Aurora, Colorado 80011 USA
Phone: 303-675-2175 or 800-344-3860 Toll Free USA/Canada
Fax: 303-675-2176 or 800-344-3867 Toll Free USA/Canada
Email: orderlit@onsemi.com

N. American Technical Support: 800-282-9855 Toll Free
USA/Canada
Europe, Middle East and Africa Technical Support:
Phone: 421 33 790 2910
Japan Customer Focus Center
Phone: 81-3-5817-1050

ON Semiconductor Website: www.onsemi.com
Order Literature: <http://www.onsemi.com/orderlit>
For additional information, please contact your local
Sales Representative

Mouser Electronics

Authorized Distributor

Click to View Pricing, Inventory, Delivery & Lifecycle Information:

[Fairchild Semiconductor:](#)

[ISL9V5036S3ST](#)