

IDS100 Series

10W, Step-Down, Single Output DC/DC Converters

Key Features

- Efficiency up To 93%
- Output Current up to 2A
- MTBF > 1,500,000 Hours
- Low Cost
- Remote On/Off Control
- Low Output Noise
- Temperature Performance -25°C to $+70^{\circ}\text{C}$
- Step-down Switching Regulator
- Overload Protection
- Standby Current 100uA only

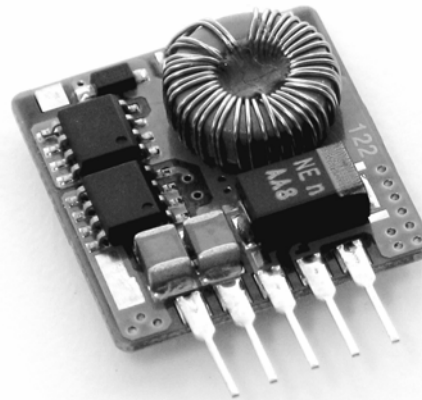

High efficiency, wide input voltage range and low output noise define Minmax's IDS Series of non-isolated, step-down, switching DC/DC converters.

The 3.3V and 5V output devices are respectively up to 93% efficiency. All models are fully line and load regulated and maintain specified accuracy over the impressively wide input voltage ranges of 4.75 to 13.6V for 3.3V output, 6 to 16.5V for 5V output and 16 to 28V for 3.3V and 5V outputs. Output ripple and noise are typically 30mV P-P.

The high efficiency of the IDS Series eliminates the need for thermally conductive potting compound. Devices are specified for full-power operation up to ambient temperatures of $+70^{\circ}\text{C}$. Calculated MTBF (MIL-HDBK-217F) is more than 1.5 million hours.

These simple-to-use power converters have no minimum load requirements. They draw 1mA when unloaded and a mere 100uA in the standby mode (On/Off Control turns off).

3.3V models have an output voltage adjustment range from 1.8 to 3.3V and 5V models are adjustable down to 3.0V.

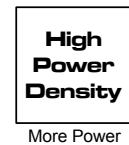
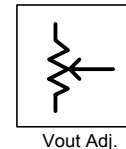
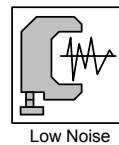
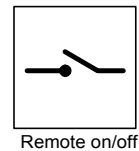
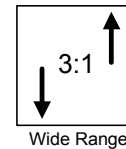

Block Diagram

Single Output

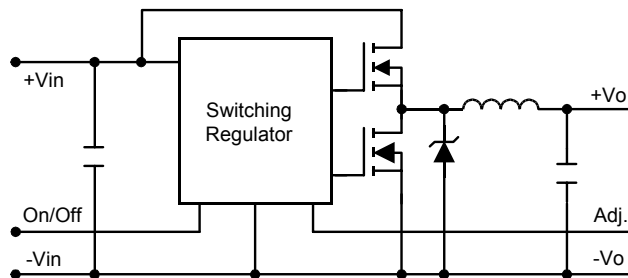

IDS100 Series

Model Selection Guide

Model Number	Input Voltage	Output Voltage	Output Current		Input Current		Efficiency
			Max.	Min.	@Max. Load	@No Load	@Max. Load
	VDC	VDC	mA	mA	mA (Typ.)	mA (Typ.)	% (Typ.)
IDS101	5 (4.75 ~ 13.6)	3.3	2000	200	1434	21	92
IDS112	12 (6 ~ 16.5)	5	2000	200	896	27	93
IDS121	24 (16 ~ 28)	3.3	2000	200	331	45	83
IDS122		5	2000	200	490		85

Absolute Maximum Ratings

Parameter	Min.	Max.	Unit	
Input Surge Voltage (1000 mS)	5VDC Input Models	-0.7	16	VDC
	12VDC Input Models	-0.7	25	VDC
	24VDC Input Models	-0.7	30	VDC
Lead Temperature (1.5mm from case for 10 Sec.)	---	235	°C	
Internal Power Dissipation	---	1500	mW	

Exceeding the absolute maximum ratings of the unit could cause damage. These are not continuous operating ratings.

Notes :

- Specifications typical at $T_a = +25^\circ\text{C}$, resistive load, nominal input voltage, rated output current unless otherwise noted.
- Transient recovery time is measured to within 1% error band for a step change in output load of 50% to 100%.
- Ripple & Noise measurement bandwidth is 0–20 MHz.
- These power converters require a minimum output loading to maintain specified regulation.
- Operation under no-load conditions will not damage these modules; however, they may not meet all specifications listed.
- All DC/DC converters should be externally fused at the front end for protection.
- Other input and output voltage may be available, please contact factory.
- Specifications subject to change without notice.

Environmental Specifications

Parameter	Conditions	Min.	Max.	Unit
Operating Temperature	Ambient	-25	+70	°C
Storage Temperature		-25	+125	°C
Humidity		---	95	%
Cooling	Free-Air Convection			

Input Specifications

Parameter	Model	Min.	Typ.	Max.	Unit
Start Voltage	5V Input Models	3.5	---	3.9	VDC
	12V Input Models	5.5	---	6	
	24V Input Models	12	---	15	

IDS100 Series

Output Specifications

Parameter	Conditions	Min.	Typ.	Max.	Unit
Output Voltage Accuracy		---	± 1.0	± 2.0	%
Line Regulation	$V_{in} = \text{Min. to Max.}$	---	± 0.2	± 0.5	%
Load Regulation	$I_o = 0\% \text{ to } 100\%$	---	± 0.5	± 1.5	%
Ripple & Noise (20MHz)		---	30	50	mV P-P
Ripple & Noise (20MHz)	Over Line, Load & Temp.	---	---	120	mV P-P
Ripple & Noise (20MHz)		---	---	15	mV rms
Over Load		120	---	---	%
Transient Recovery Time	50% Load Step Change	---	100	150	μS
Transient Response Deviation		---	± 2	± 4	%
Temperature Coefficient		---	± 0.01	± 0.02	%/°C
Output Short Circuit	Continuous				

General Specifications

Parameter	Conditions	Min.	Typ.	Max.	Unit
Isolation Voltage	none				
Switching Frequency		---	300	---	KHz
MTBF	MIL-HDBK-217F @ 25°C, Ground Benign	1500	---	---	K Hours

Remote On/Off Control

Parameter	Conditions	Min.	Typ.	Max.	Unit
Supply On	3.0 to 5.0VDC or Open Circuit				VDC
Supply Off		-0.3	---	1.2	VDC
Device Standby Input Current		---	100	300	μA
Control Input Current (on)		---	---	50	μA
Control Input Current (off)		---	---	-100	μA
Control Common	Referenced to Negative Input				

Output Voltage Trim

Parameter	Models	Min.	Typ.	Max.	Unit
Trim Down Range	IDS101, IDS121	1.8	---	3.3	VDC
	IDS112, IDS122	3	---	5	VDC

Input Fuse Selection Guide

5V Input Models	12V Input Models	24V Input Models
4000mA Slow – Blow Type	3000mA Slow – Blow Type	1000mA Slow – Blow Type

IDS100 Series

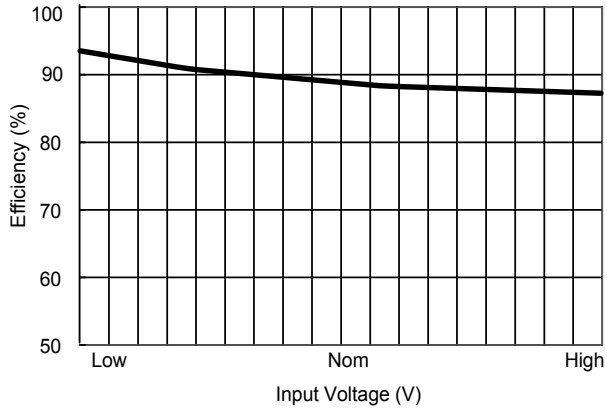

Efficiency vs Input Voltage

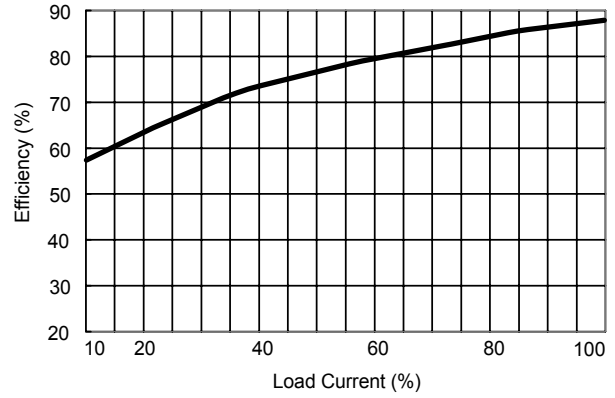

Efficiency vs Output Load

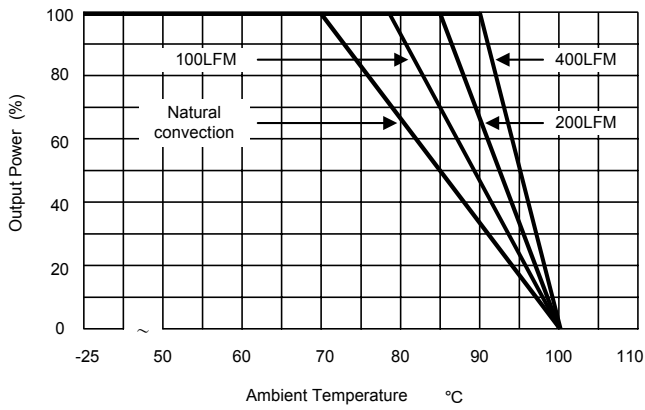

Derating Curve

IDS100 Series

Test Configurations

Peak-to-Peak Output Noise Measurement Test

Use a Cout 4.7uF ceramic capacitor.

Scope measurement should be made by using a BNC socket, measurement bandwidth is 0–20 MHz. Position the load between 50 mm and 75 mm from the DC/DC Converter.

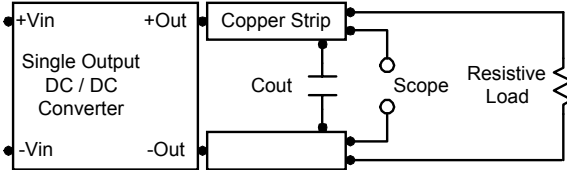

Design & Feature Considerations

Remote On/Off

Positive logic remote on/off turns the module on during a logic high voltage on the remote on/off pin, and off during a logic low.

Negative logic remote on/off turns the module off during a logic low and on during a logic high.

To turn the power module on and off, the user must supply a switch to control the voltage between the on/off terminal and the -Vin terminal.

The switch can be an open collector or equivalent.

A logic low is -0.3V to 1.2V.

A logic high is 3.0V to 5.0V.

The maximum sink current at on/off terminal during a logic low is -100 uA.

The maximum allowable leakage current of the switch at on/off terminal (3.0 to 5.0V) is 50uA.

Overcurrent Protection

To provide protection in a fault (output overload) condition, the unit is equipped with internal current limiting circuitry and can endure current limiting for an unlimited duration. At the point of current-limit inception, the unit shifts from voltage control to current control. The unit operates normally once the output current is brought back into its specified range.

Output Ripple Reduction

A good quality low ESR capacitor placed as close as practicable across the load will give the best ripple and noise performance.

To reduce output ripple, it is recommended to use 22uF capacitors at the output.

Input Source Impedance

The power module should be connected to a low ac-impedance input source. Highly inductive source impedances can affect the stability of the power module.

In applications where power is supplied over long lines and output loading is high, it may be necessary to use a capacitor at the input to ensure startup.

Capacitor mounted close to the power module helps ensure stability of the unit, it is recommended to use a good quality low Equivalent Series Resistance (ESR < 1.0Ω at 100 KHz) capacitor of a 100uF for the 5V input devices and a 33uF for the 12V and 24V devices.

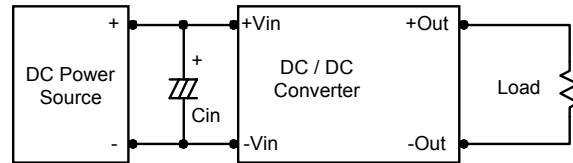

Output Voltage Trim

Connecting the external resistor (Radj) between the Vadj and +Vout pins decreases the output voltage to set the point as defined in the following equation:

$$VR1 = \frac{(Rx \cdot 1200) \cdot (Vo - 1.195)}{(Rx \cdot 1.195) - [1200 \cdot (Vo - 1.195)]}$$

IDS101 and IDS121 ==> Rx=2130Ω

Output Voltage range is 1.8–3.3VDC.

IDS112 and IDS122==> Rx=3840Ω

Output Voltage range is 3.0–5.0VDC.

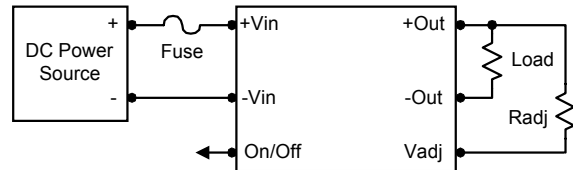

Thermal Considerations

Many conditions affect the thermal performance of the power module, such as orientation, airflow over the module and board spacing. To avoid exceeding the maximum temperature rating of the components inside the power module, the ambient temperature must be kept below 70°C.

The derating curves are determined from measurements obtained in an experimental apparatus.

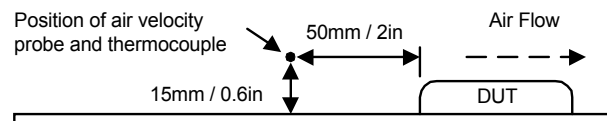

IDS100 Series

Mechanical Dimensions

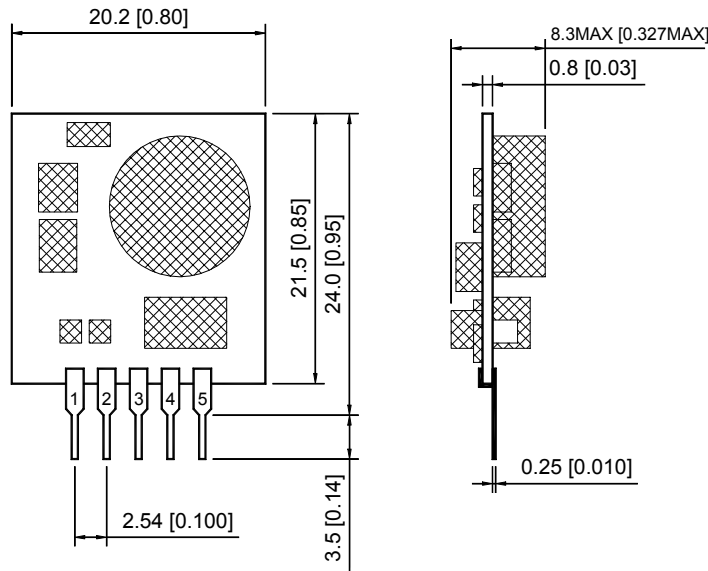

Tolerance	Millimeters	Inches
	X.X±0.25	X.XX±0.01
	X.XX±0.13	X.XXX±0.005
Pin	±0.05	±0.002

Pin Connections

Pin	Function
1	Remote On/Off
2	+Vin
3	-Vin
4	+Vout
5	Trim

Physical Characteristics

Vibration : 5 to 10Hz amplitude 10mm pk-pk
10 to 55Hz acceleration 2G

Shock : Acceleration 20G max. time 11 ms

Weight : 8.6g

Soldering temperature : 235°C max./10sec

Leads are tin plated for improved solderability.