

## Instrumentation Operational Amplifier

### GENERAL DESCRIPTION

The μPC254 of Monolithic Instrumentation Operational Amplifier exhibits excellent performance in low signal level applications with the flexibility and ease of application of a fully protected, internally compensated op amp. Main features are low offset voltage, bias current and noise and high gain, input impedance, CMRR and SVRR.

The μPC254 is an optimum choice for a wide variety of applications including strain gauge, thermocouple bridges, high gain active filters, buffers, integrators, and sample and hold amplifiers.

### FEATURES

- Low Input Offset Voltage Drift vs Temp . . . . .  $0.4 \mu\text{V}/^\circ\text{C}$  (Null) Typ.
- Low Input Offset Voltage Drift vs Time . . . . .  $0.4 \mu\text{V}/\text{Month}$  Typ.
- Low Input Offset Voltage . . . . .  $0.3 \text{ mV}$  Typ.
- Low Input Bias Current . . . . .  $\pm 1.8 \text{ nA}$  Typ.
- High Gain
- Low Noise
- High CMRR
- Internally Frequency Compensated.
- Easy Offset Nulling
- OP-05C Direct Replacement

### EQUIVALENT CIRCUIT

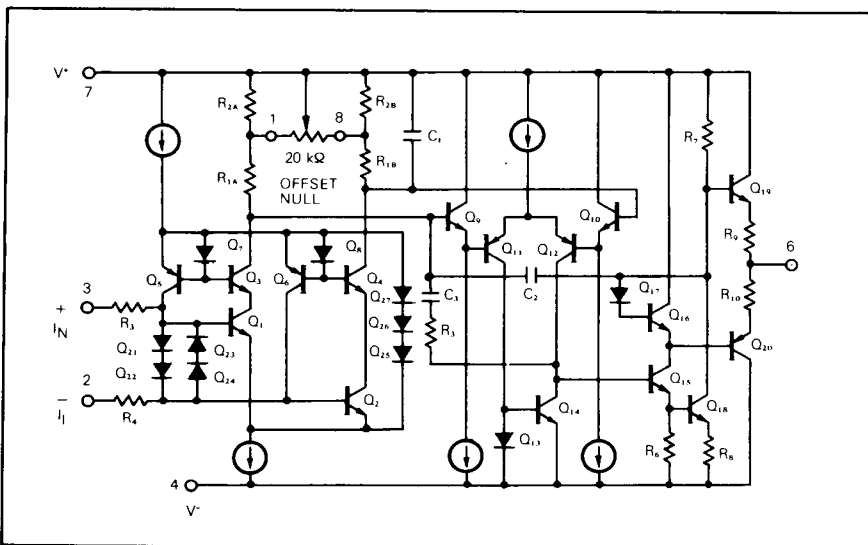

### ORDERING INFORMATION

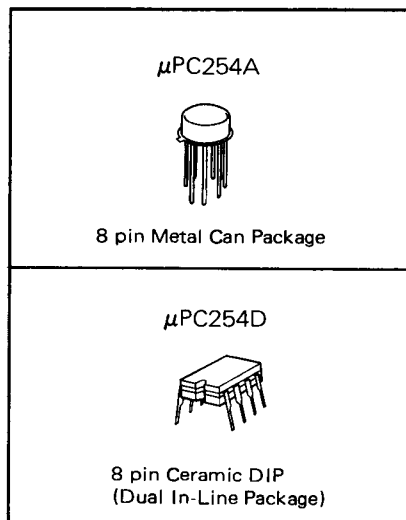

### CONNECTION DIAGRAM (Top View)

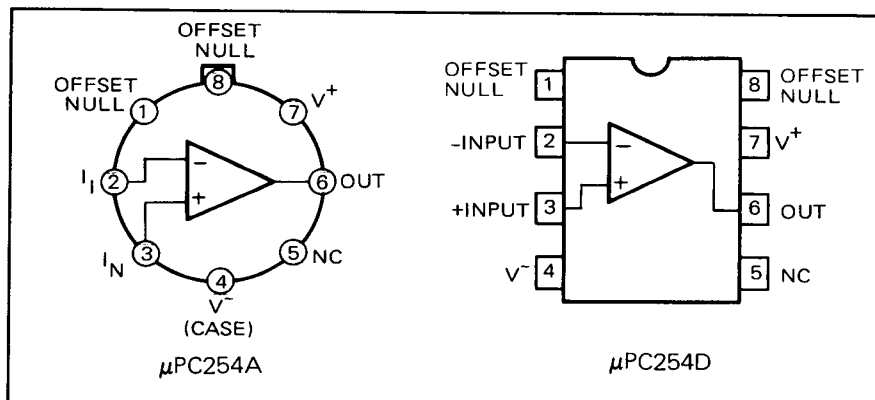

**ABSOLUTE MAXIMUM RATINGS (Ta = 25°C)**

PARAMETER		μPC254	UNIT
Voltage between V <sup>+</sup> and V <sup>-</sup>		44	V
Power Dissipation *	A or D Package	500	mW
Differential Input Voltage		±30	V
Input Voltage (Note 1)		±22	V
Output Short Circuit Duration		Indefinite	s
Operating Temperature Range	A or D Package	-20 to +80	°C
Storage Temperature Range	A Package	-60 to +175	°C
	D Package	-55 to +150	

Note 1: For supply voltages less than ±22 V, the absolute maximum input voltage is equal to the supply voltage.

\* See thermal information in chapter 11.

**ELECTRICAL CHARACTERISTICS (Ta = 25°C, V<sup>±</sup> = ±15 V)**

CHARACTERITIC	MIN.	TYP.	MAX.	UNIT	CONDITIONS
Input Offset Voltage		0.3	1.3	mV	Rs ≤ 100 Ω
Average Input Offset Voltage Drift		1.2	4.5	μV/°C	Rs ≤ 100 Ω, unnull (Note 2)
Average Input Offset Voltage Drift		0.4	1.5		Rs ≤ 100 Ω, null, Rp=20 kΩ (Note 2)
Input Offset Current		1.8	6.0	nA	
Average Input Offset Current Drift		12	50	pA/°C	(Note 2)
Input Bias Current		±1.8	±7.0	nA	
Average Input Bias Current Drift		18	50	pA/°C	(Note 2)
Input Resistance – Dif Mode	8	33		MΩ	
Large Signal Voltage Gain	120	500		V/mV	RL ≥ 2 kΩ, Vo = ±10 V
Supply Current		3.2	5.0	mA	V <sup>±</sup> = ±3 V
		0.67	1.3		
Power Consumption		95	150	mW	
Maximum Output Voltage Swing	±12.0	±13.0		V	RL ≥ 10 kΩ
	±11.5	±12.8			RL ≥ 2 kΩ
	±1.45	±1.6			V <sup>±</sup> = ±3 V, RL ≥ 2 kΩ
Common Mode Rejection Ratio	100	120		dB	
Power Supply Rejection Ratio	90	104		dB	V <sup>±</sup> = ±3 V → ±18 V
Offset Adjustment Range		4		mV	Rp = 20 kΩ
Input Noise Voltage		0.5		μVp-p	Rs = 10 kΩ, f = 0.1 ~ 10 Hz (Note 2)
Input Noise Voltage Density		10.5	20.0	nV/√Hz	f <sub>o</sub> = 10 Hz (Note 2)
		10.2	13.5		f <sub>o</sub> = 100 Hz (Note 2)
		9.8	11.5		f <sub>o</sub> = 1000 Hz (Note 2)
Input Noise Current Density		0.35	0.90	pA/√Hz	f <sub>o</sub> = 10 Hz (Note 2)
		0.15	0.27		f <sub>o</sub> = 100 Hz (Note 2)
		0.13	0.18		f <sub>o</sub> = 1000 Hz (Note 2)
Long Term Input Offset Voltage Stability		0.4	2.0	μV/Mo	(Note 2)

Note 2: Paramotor is not 100 % tested, 90 % of units meet this specification.

**OFFSET NULLING CIRCUIT**

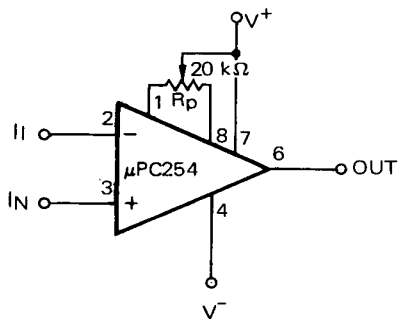

The μPC254 is designed to provide lowest drift performance when trimmed with a 20 kΩ potentiometer. When fine resolution of trimming is desired or where unwanted changes in potentiometer position with time and temperature could create unacceptable offsets, the sensitivity to offset vs potentiometer may be reduced by using the circuit shown below.

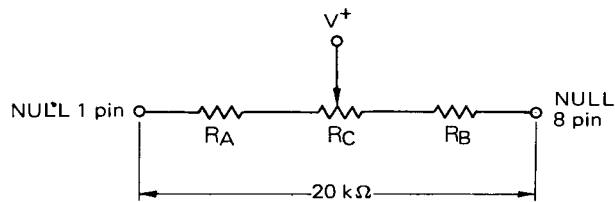

Fixed Resistor  $R_A, R_B$  5.1 kΩ  
 Potentiometer  $R_C$  10.0 kΩ  
 Null Range ±1.2 mV Typ.

**OPEN LOOP FREQUENCY RESPONSE**

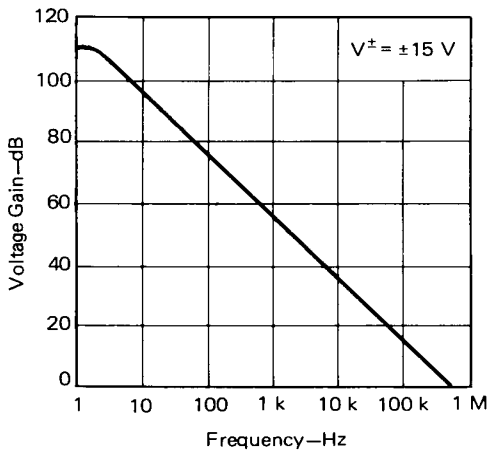

**LARGE SIGNAL FREQUENCY RESPONSE**

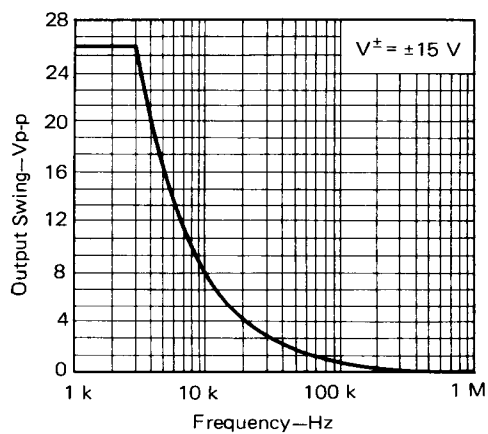

**SUPPLY CURRENT**

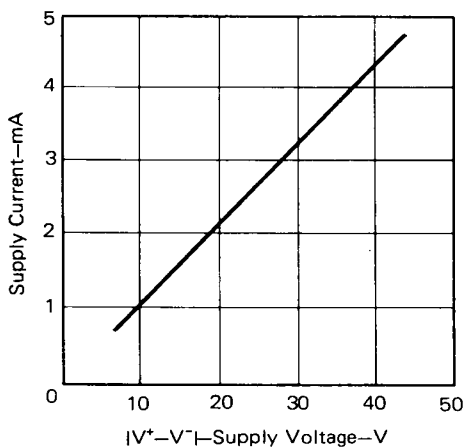

**POWER DISSIPATION**

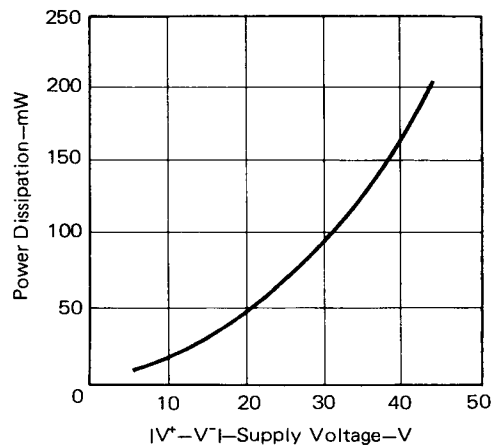

COMMON MODE REJECTION RATIO

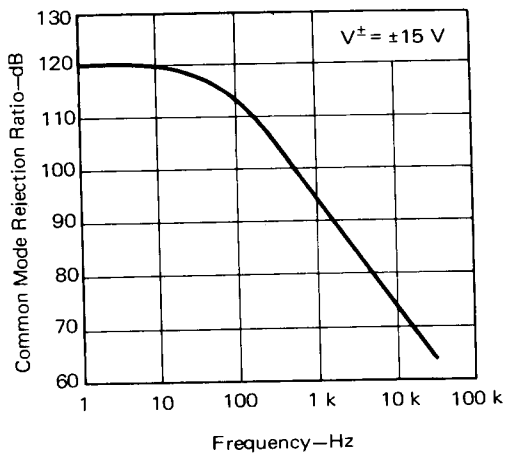

POWER SUPPLY REJECTION RATIO

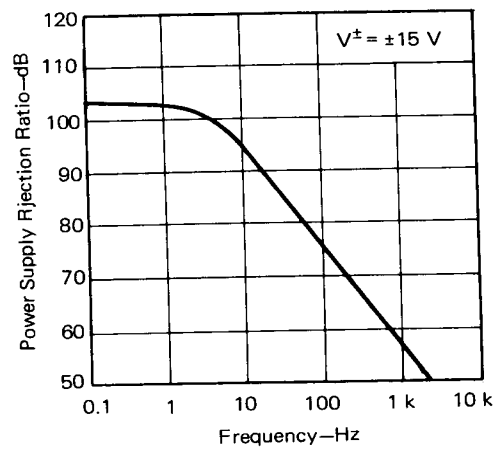

MAXIMUM OUTPUT VOLTAGE

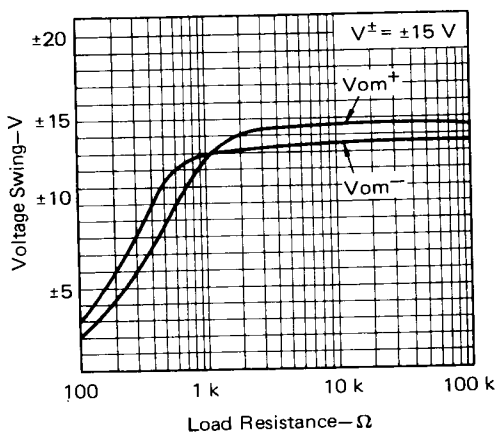

OFFSET VOLTAGE ADJUSTMENT

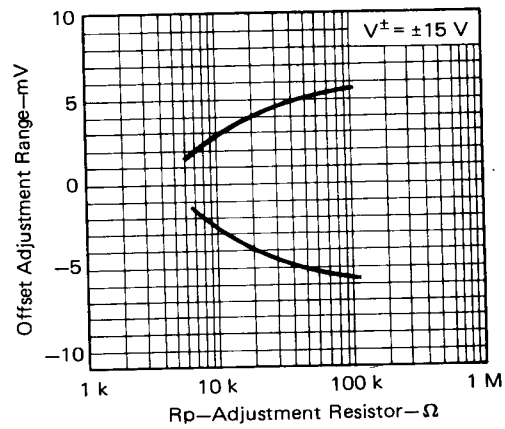

VOLTAGE GAIN

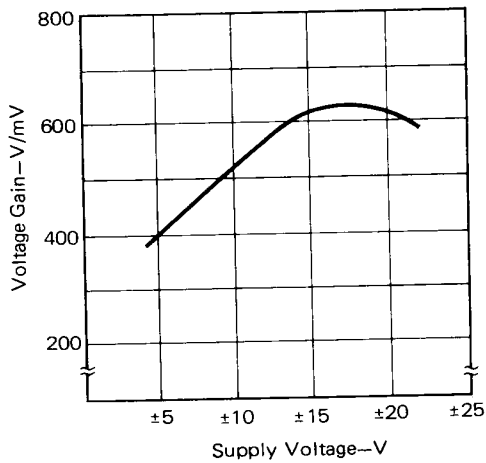

VOLTAGE GAIN

