

SEMITOP[®] 2

IGBT Module

SK50GB065

Preliminary Data

Features

- Compact design
- One screw mounting
- Heat transfer and isolation through direct copper bonded aluminium oxide ceramic (DCB)
- N-channel homogeneous silicon structure (NPT-Non-Punch-Through IGBT)
- Low tail current with low temperature dependence
- Low threshold voltage

Typical Applications*

- Switching (not for linear use)
- Inverter
- Switched mode power supplies
- UPS

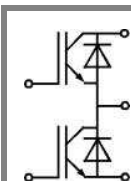

GB

Absolute Maximum Ratings		$T_s = 25\text{ °C}$, unless otherwise specified	
Symbol	Conditions	Values	Units
IGBT			
V_{CES}	$T_j = 25\text{ °C}$	600	V
I_C	$T_j = 125\text{ °C}$	$T_s = 25\text{ °C}$	54 A
		$T_s = 80\text{ °C}$	40 A
I_{CRM}	$I_{CRM} = 2 \times I_{Cnom}$	60	A
V_{GES}		± 20	V
t_{psc}	$V_{CC} = 300\text{ V}$; $V_{GE} \leq 20\text{ V}$; $T_j = 125\text{ °C}$ $V_{CES} < 600\text{ V}$	10	μs
Inverse Diode			
I_F	$T_j = 150\text{ °C}$	$T_s = 25\text{ °C}$	64 A
		$T_s = 80\text{ °C}$	48 A
I_{FRM}	$I_{FRM} = 2 \times I_{Fnom}$		A
I_{FSM}	$t_p = 10\text{ ms}$; half sine wave $T_j = 150\text{ °C}$	200	A
Module			
$I_{t(RMS)}$			A
T_{vj}		-40 ... +150	$^{\circ}\text{C}$
T_{stg}		-40 ... +125	$^{\circ}\text{C}$
V_{isol}	AC, 1 min.	2500	V

Characteristics		$T_s = 25\text{ °C}$, unless otherwise specified			
Symbol	Conditions	min.	typ.	max.	Units
IGBT					
$V_{GE(th)}$	$V_{GE} = V_{CE}$, $I_C = 1,4\text{ mA}$	3	4	5	V
I_{CES}	$V_{GE} = 0\text{ V}$, $V_{CE} = V_{CES}$ $T_j = 25\text{ °C}$			0,0044	mA
I_{GES}	$V_{CE} = 0\text{ V}$, $V_{GE} = 20\text{ V}$ $T_j = 25\text{ °C}$			240	nA
V_{CE0}		$T_j = 25\text{ °C}$	1,1		V
		$T_j = 125\text{ °C}$	1,1		V
r_{CE}	$V_{GE} = 15\text{ V}$	$T_j = 25\text{ °C}$	15		$\text{m}\Omega$
		$T_j = 125\text{ °C}$	19		$\text{m}\Omega$
$V_{CE(sat)}$	$I_{Cnom} = 60\text{ A}$, $V_{GE} = 15\text{ V}$	$T_j = 25\text{ °C}_{chiplev.}$	2	2,5	V
		$T_j = 125\text{ °C}_{chiplev.}$	2,2		V
C_{ies}	$V_{CE} = 25$, $V_{GE} = 0\text{ V}$ $f = 1\text{ MHz}$		3,2		nF
C_{oes}		0,3		nF	
C_{res}		0,18		nF	
$t_{d(on)}$	$R_{Gon} = 16\ \Omega$	$V_{CC} = 300\text{ V}$ $I_C = 40\text{ A}$	60	80	ns
t_r			30	40	ns
E_{on}	$R_{Goff} = 16\ \Omega$	$T_j = 125\text{ °C}$ $V_{GE} = \pm 15\text{ V}$	1,1	1,4	mJ
$t_{d(off)}$			220	280	ns
t_f			20	26	ns
E_{off}			0,7	0,9	mJ
$R_{th(j-s)}$	per IGBT			0,85	K/W



SEMITOP® 2

IGBT Module

SK50GB065

Preliminary Data

Features

- Compact design
- One screw mounting
- Heat transfer and isolation through direct copper bonded aluminium oxide ceramic (DCB)
- N-channel homogeneous silicon structure (NPT-Non-Punch-Through IGBT)
- Low tail current with low temperature dependence
- Low threshold voltage

Typical Applications*

- Switching (not for linear use)
- Inverter
- Switched mode power supplies
- UPS

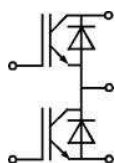

GB

Characteristics

Symbol	Conditions	min.	typ.	max.	Units	
Inverse Diode						
$V_F = V_{EC}$	$I_{Fnom} = 50 \text{ A}; V_{GE} = 0 \text{ V}$		$T_j = 25 \text{ }^\circ\text{C}_{\text{chiplev.}}$	1,45	1,7	V
			$T_j = 150 \text{ }^\circ\text{C}_{\text{chiplev.}}$	1,4	1,75	V
V_{F0}			$T_j = 25 \text{ }^\circ\text{C}$			V
			$T_j = 125 \text{ }^\circ\text{C}$	0,85	0,9	V
r_F			$T_j = 25 \text{ }^\circ\text{C}$			mΩ
			$T_j = 125 \text{ }^\circ\text{C}$	11	16	mΩ
I_{RRM}	$I_F = 50 \text{ A}$		$T_j = 125 \text{ }^\circ\text{C}$	40		A
Q_{rr}	$di/dt = -1000 \text{ A}/\mu\text{s}$			3,6		μC
E_{rr}	$V_{CC} = 300\text{V}$			0,55		mJ
$R_{th(j-s)D}$	per diode				1,1	K/W
M_s	to heat sink				2	Nm
w				19		g

This is an electrostatic discharge sensitive device (ESDS), international standard IEC 60747-1, Chapter IX.

* The specifications of our components may not be considered as an assurance of component characteristics. Components have to be tested for the respective application. Adjustments may be necessary. The use of SEMIKRON products in life support appliances and systems is subject to prior specification and written approval by SEMIKRON. We therefore strongly recommend prior consultation of our personal.

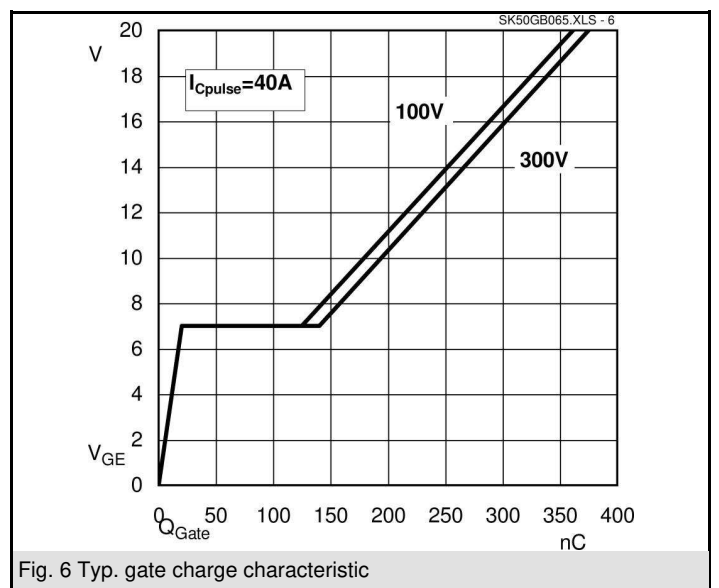
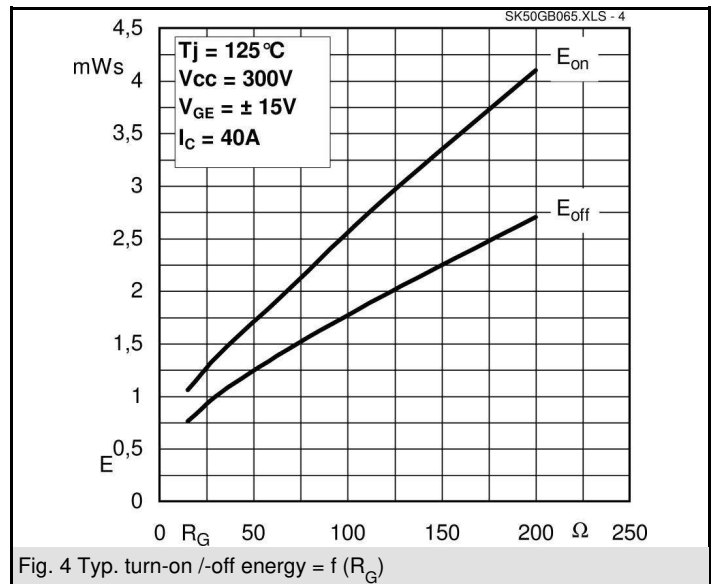
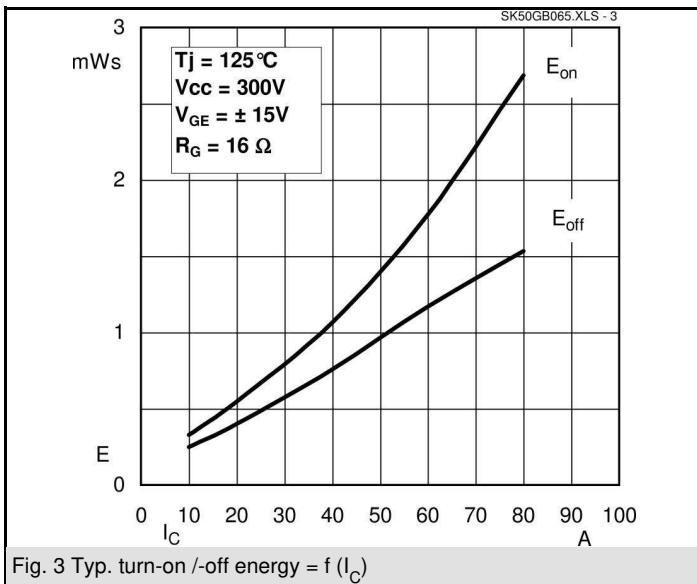
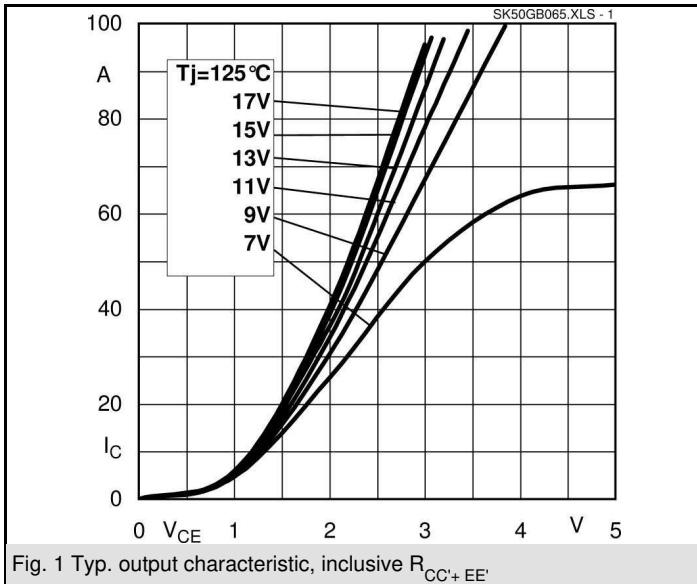

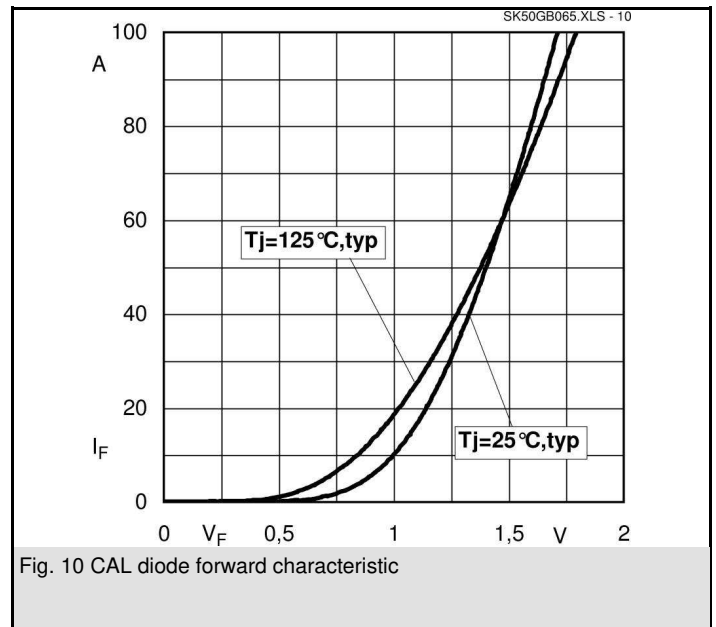
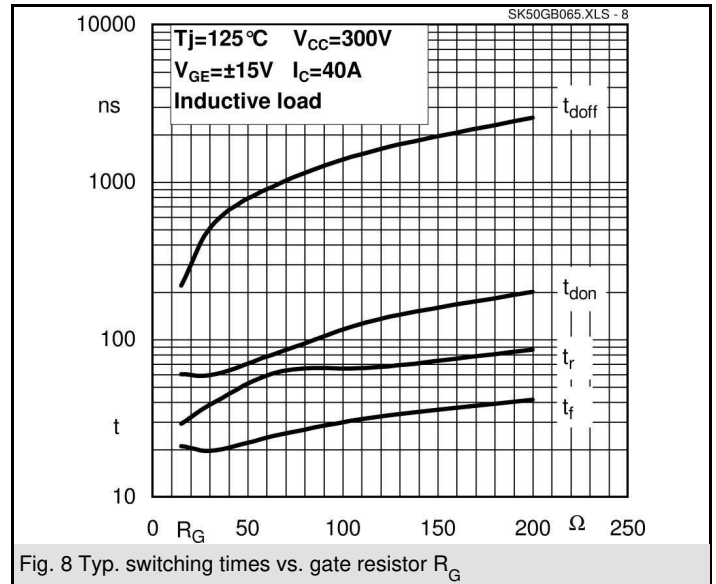
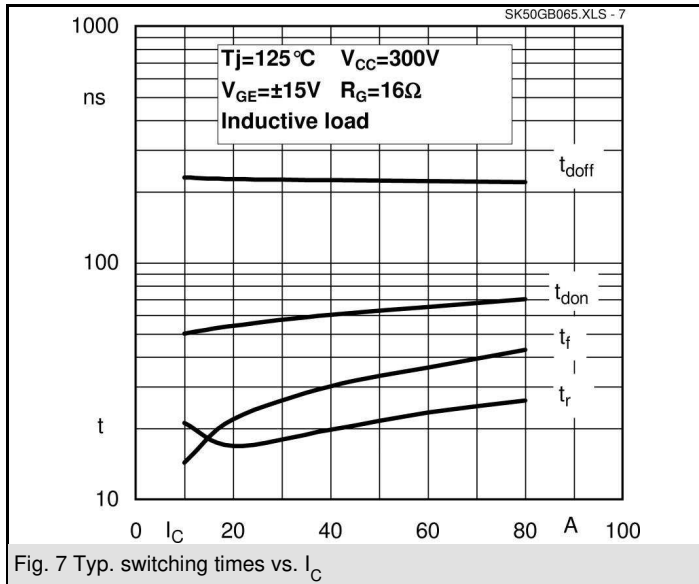

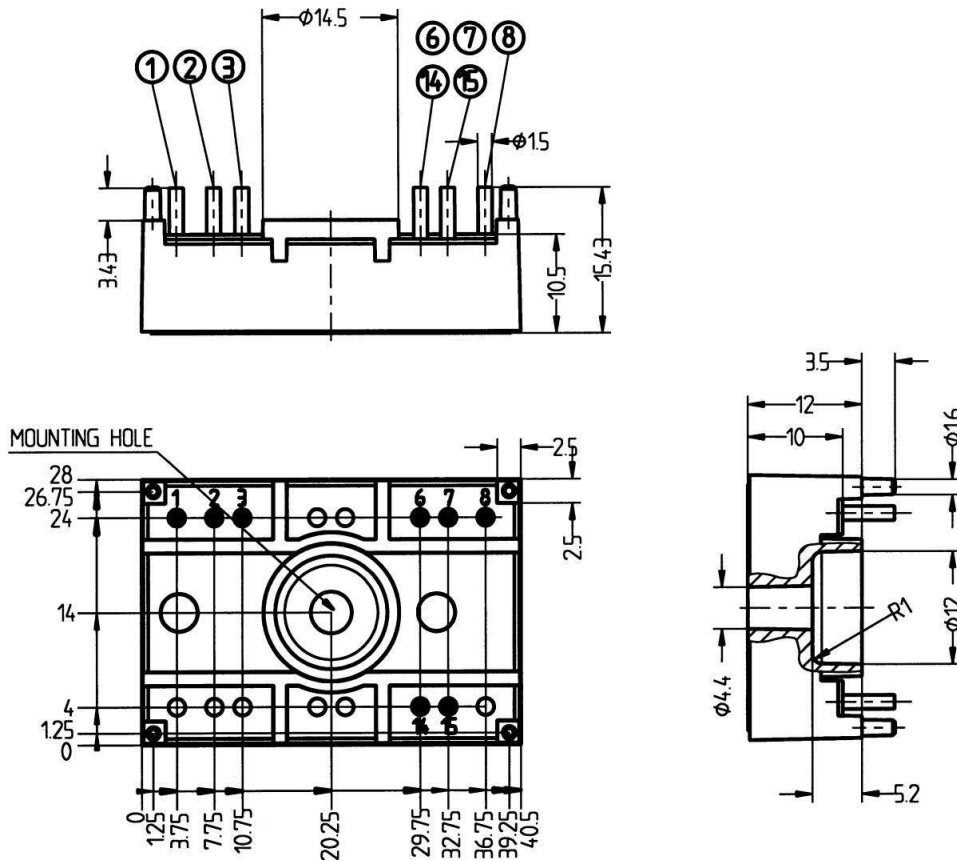

Case T32 (Suggested hole diameter, in the PCB, for solder pins and plastic mounting pins: 2mm)

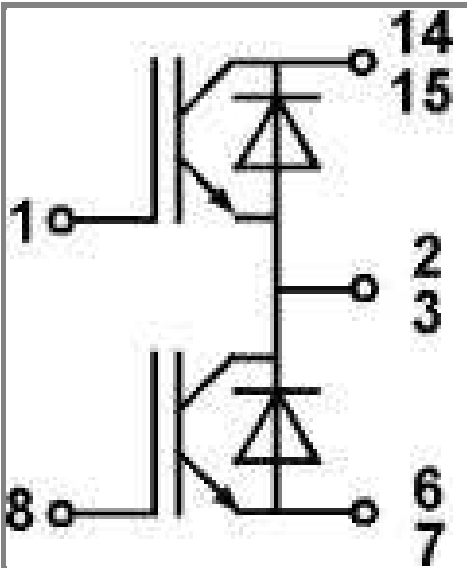

Case T 32

GB