

FEATURES

Low power, quad *nano*DACs

AD5664: 16 bits

AD5624: 12 bits

Relative accuracy: ± 12 LSBs max

Guaranteed monotonic by design

10-lead MSOP and 3 mm \times 3 mm LFCSP_WD

2.7 V to 5.5 V power supply

Power-on reset to zero

Per channel power-down

Serial interface, up to 50 MHz

APPLICATIONS

Process control

Data acquisition systems

Portable battery-powered instruments

Digital gain and offset adjustment

Programmable voltage and current sources

Programmable attenuators

GENERAL DESCRIPTION

The AD5624/AD5664, members of the *nano*DAC® family, are low power, quad, 12-, 16-bit buffered voltage-out DACs that operate from a single 2.7 V to 5.5 V supply and are guaranteed monotonic by design.

The AD5624/AD5664 require an external reference voltage to set the output range of the DAC. The device incorporates a power-on reset circuit that ensures the DAC output powers up to 0 V and remains there until a valid write takes place. The devices contain a power-down feature that reduces the current consumption of the device to 480 nA at 5 V and provides software-selectable output loads while in power-down mode.

The low power consumption of these devices in normal operation makes them ideally suited to portable battery-operated equipment. The power consumption is 2.25 mW at 5 V, going down to 2.4 μ W in power-down mode.

The AD5624/AD5664 on-chip precision output amplifier allows rail-to-rail output swing to be achieved.

FUNCTIONAL BLOCK DIAGRAM

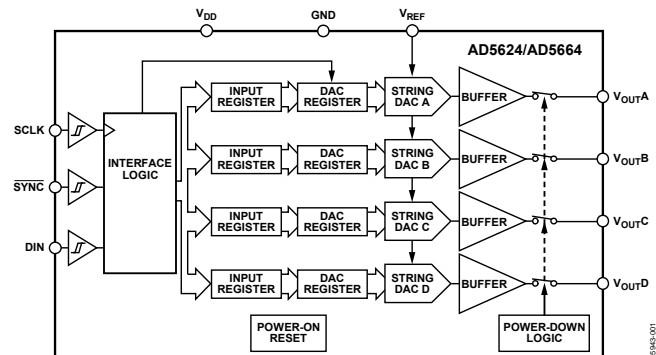

Figure 1.

The AD5624/AD5664 use a versatile 3-wire serial interface that operates at clock rates up to 50 MHz, and are compatible with standard SPI®, QSPI™, MICROWIRE™, and DSP interface standards.

PRODUCT HIGHLIGHTS

1. Relative accuracy: ± 12 LSBs maximum.
2. Available in 10-lead MSOP and 10-lead, 3 mm \times 3 mm, LFCSP_WD.
3. Low power, typically consumes 1.32 mW at 3 V and 2.25 mW at 5 V.
4. Maximum settling time of 4.5 μ s (AD5624) and 7 μ s (AD5664).

Table 1. Related Devices

Part No.	Description
AD5624R/AD5644R/AD5664R	2.7 V to 5.5 V quad, 12-, 14-, 16-bit DACs with internal reference

TABLE OF CONTENTS

Features	1	Serial Interface	15
Applications.....	1	Input Shift Register	16
Functional Block Diagram	1	$\overline{\text{SYNC}}$ Interrupt	16
General Description	1	Power-On Reset	16
Product Highlights	1	Software Reset.....	17
Revision History	2	Power-Down Modes	17
Specifications.....	3	LDAC Function	18
AC Characteristics.....	4	Microprocessor Interfacing.....	19
Timing Characteristics	5	Applications Information	20
Timing Diagram	5	Choosing a Reference for the AD5624/AD5664.....	20
Absolute Maximum Ratings.....	6	Using a Reference as a Power Supply for the AD5624/AD5664.....	20
ESD Caution.....	6	Bipolar Operation Using the AD5624/AD5664.....	21
Pin Configuration and Function Descriptions.....	7	Using AD5624/AD5664 with a Galvanically Isolated Interface.....	21
Typical Performance Characteristics	8	Power Supply Bypassing and Grounding.....	21
Terminology	13	Outline Dimensions	22
Theory of Operation	15	Ordering Guide.....	23
D/A Section	15		
Resistor String.....	15		
Output Amplifier.....	15		

REVISION HISTORY

6/2018—Rev. 0 to Rev. A

Changes to Figure 3 Caption and Table 6.....	7
Add Figure 4; Renumber Sequentially.....	7
Changed Applications Section to Applications Information Section.....	20
Updated Outline Dimensions	22
Changes to Ordering Guide	23

6/2006—Revision 0: Initial Version

SPECIFICATIONS

$V_{DD} = +2.7\text{ V to }+5.5\text{ V}$; $R_L = 2\text{ k}\Omega$ to GND; $C_L = 200\text{ pF}$ to GND; $V_{REF} = V_{DD}$; all specifications T_{MIN} to T_{MAX} , unless otherwise noted.

Table 2.

Parameter	A Grade ¹			B Grade ¹			Unit	Conditions/Comments
	Min	Typ	Max	Min	Typ	Max		
STATIC PERFORMANCE ²								
AD5664								
Resolution	16			16			Bits	Guaranteed monotonic by design
Relative Accuracy		±8	±16		±6	±12	LSB	
Differential Nonlinearity			±1			±1	LSB	
AD5624								
Resolution				12			Bits	Guaranteed monotonic by design
Relative Accuracy					±0.5	±1	LSB	
Differential Nonlinearity						±0.25	LSB	
Zero Code Error		2	10		2	10	mV	All zeroes loaded to DAC register
Offset Error		±1	±10		±1	±10	mV	
Full-Scale Error		-0.1	±1		-0.1	±1	% of FSR	All ones loaded to DAC register
Gain Error			±1.5			±1.5	% of FSR	
Zero Code Error Drift		±2			±2		μV/°C	
Gain Temperature Coefficient		±2.5			±2.5		ppm	Of FSR/°C
DC Power Supply Rejection Ratio		-100			-100		dB	DAC code = midscale; $V_{DD} \pm 10\%$
DC Crosstalk		10			10		μV	Due to full-scale output change $R_L = 2\text{ k}\Omega$ to GND or V_{DD}
		10			10		μV/mA	Due to load current change
		5			5		μV	Due to powering down (per channel)
OUTPUT CHARACTERISTICS ³								
Output Voltage Range	0		V_{DD}	0		V_{DD}	V	
Capacitive Load Stability		2			2		nF	$R_L = \infty$
		10			10		nF	$R_L = 2\text{ k}\Omega$
DC Output Impedance		0.5			0.5		Ω	
Short-Circuit Current		30			30		mA	$V_{DD} = 5\text{ V}$
Power-Up Time		4			4		μs	Coming out of power-down mode; $V_{DD} = 5\text{ V}$
REFERENCE INPUTS								
Reference Current		170	200		170	200	μA	$V_{REF} = V_{DD} = 5.5\text{ V}$
Reference Input Range	0.75		V_{DD}	0.75		V_{DD}	V	
Reference Input Impedance		26			26		kΩ	
LOGIC INPUTS ³								
Input Current			±2			±2	μA	All digital inputs
V_{INL} , Input Low Voltage			0.8			0.8	V	$V_{DD} = 5\text{ V}, 3\text{ V}$
V_{INH} , Input High Voltage	2			2			V	$V_{DD} = 5\text{ V}, 3\text{ V}$
Pin Capacitance		3			3		pF	

Parameter	A Grade ¹			B Grade ¹			Unit	Conditions/Comments
	Min	Typ	Max	Min	Typ	Max		
POWER REQUIREMENTS								
V_{DD}	2.7		5.5	2.7		5.5	V	$V_{IH} = V_{DD}, V_{IL} = GND$
I_{DD} (Normal Mode) ⁴								
$V_{DD} = 4.5\text{ V to }5.5\text{ V}$		0.45	0.9		0.45	0.9	mA	
$V_{DD} = 2.7\text{ V to }3.6\text{ V}$		0.44	0.85		0.44	0.85	mA	
I_{DD} (All Power-Down Modes) ⁵								$V_{IH} = V_{DD}, V_{IL} = GND$
$V_{DD} = 4.5\text{ V to }5.5\text{ V}$		0.48	1		0.48	1	μA	
$V_{DD} = 2.7\text{ V to }3.6\text{ V}$		0.2	1		0.2	1	μA	

¹ Temperature range: A grade and B grade: -40°C to $+105^{\circ}\text{C}$.

² Linearity calculated using a reduced code range: AD5664 (Code 512 to Code 65,024); AD5624 (Code 32 to Code 4064); output unloaded.

³ Guaranteed by design and characterization, not production tested.

⁴ Interface inactive. All DACs active. DAC outputs unloaded.

⁵ All DACs powered down.

AC CHARACTERISTICS

$V_{DD} = 2.7\text{ V to }5.5\text{ V}$; $R_L = 2\text{ k}\Omega$ to GND; $C_L = 200\text{ pF}$ to GND; $V_{REF} = V_{DD}$; all specifications T_{MIN} to T_{MAX} , unless otherwise noted.¹

Table 3.

Parameter ^{2,3}	Min	Typ	Max	Unit	Conditions/Comments
Output Voltage Settling Time					
AD5664		4	7	μs	$\frac{1}{4}$ to $\frac{3}{4}$ scale settling to ± 2 LSB
AD5624		3	4.5	μs	$\frac{1}{4}$ to $\frac{3}{4}$ scale settling to ± 0.5 LSB
Slew Rate		1.8		$\text{V}/\mu\text{s}$	
Digital-to-Analog Glitch Impulse		10		nV-s	1 LSB change around major carry
Digital Feedthrough		0.1		nV-s	
Reference Feedthrough		-90		dBs	$V_{REF} = 2\text{ V} \pm 0.1\text{ V p-p}$, frequency 10 Hz to 20 MHz
Digital Crosstalk		0.1		nV-s	
Analog Crosstalk		1		nV-s	
DAC-to-DAC Crosstalk		1		nV-s	
Multiplying Bandwidth		340		kHz	$V_{REF} = 2\text{ V} \pm 0.1\text{ V p-p}$
Total Harmonic Distortion		-80		dB	$V_{REF} = 2\text{ V} \pm 0.1\text{ V p-p}$, frequency = 10 kHz
Output Noise Spectral Density		120		$\text{nV}/\sqrt{\text{Hz}}$	DAC code = midscale, 1 kHz
		100		$\text{nV}/\sqrt{\text{Hz}}$	DAC code = midscale, 10 kHz
Output Noise		15		$\mu\text{V p-p}$	0.1 Hz to 10 Hz

¹ Guaranteed by design and characterization, not production tested.

² Temperature range: -40°C to $+105^{\circ}\text{C}$; typical at 25°C .

³ See the Terminology section.

TIMING CHARACTERISTICS

All input signals are specified with $t_R = t_F = 1 \text{ ns/V}$ (10% to 90% of V_{DD}) and timed from a voltage level of $(V_{IL} + V_{IH})/2$ (see Figure 2). $V_{DD} = 2.7 \text{ V to } 5.5 \text{ V}$; all specifications T_{MIN} to T_{MAX} , unless otherwise noted.

Table 4.

Parameter ¹	Limit at T_{MIN}, T_{MAX} $V_{DD} = 2.7 \text{ V to } 5.5 \text{ V}$	Unit	Conditions/Comments
t_1^2	20	ns min	SCLK cycle time
t_2	9	ns min	SCLK high time
t_3	9	ns min	SCLK low time
t_4	13	ns min	$\overline{\text{SYNC}}$ to SCLK falling edge setup time
t_5	5	ns min	Data setup time
t_6	5	ns min	Data hold time
t_7	0	ns min	SCLK falling edge to $\overline{\text{SYNC}}$ rising edge
t_8	15	ns min	Minimum $\overline{\text{SYNC}}$ high time
t_9	13	ns min	$\overline{\text{SYNC}}$ rising edge to SCLK fall ignore
t_{10}	0	ns min	SCLK falling edge to $\overline{\text{SYNC}}$ fall ignore

¹ Guaranteed by design and characterization, not production tested.

² Maximum SCLK frequency is 50 MHz at $V_{DD} = 2.7 \text{ V to } 5.5 \text{ V}$.

TIMING DIAGRAM

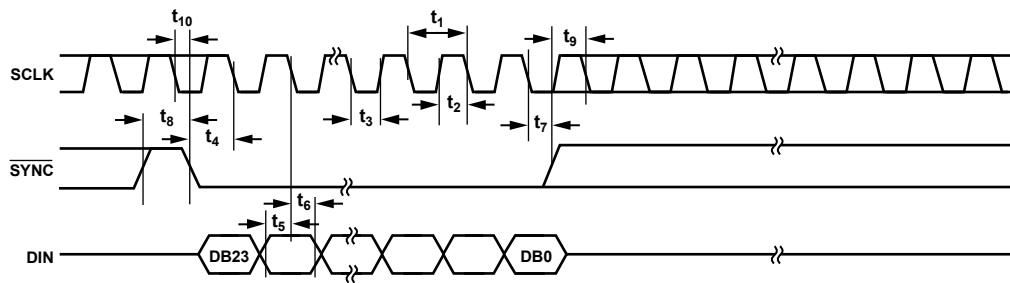

Figure 2. Serial Write Operation

0 8943-002

ABSOLUTE MAXIMUM RATINGS

$T_A = 25^\circ\text{C}$, unless otherwise noted.

Table 5.

Parameter	Rating
V_{DD} to GND	-0.3 V to +7 V
V_{OUT} to GND	-0.3 V to $V_{DD} + 0.3$ V
V_{REF} to GND	-0.3 V to $V_{DD} + 0.3$ V
Digital Input Voltage to GND	-0.3 V to $V_{DD} + 0.3$ V
Operating Temperature Range	
Industrial (A Grade, B Grade)	-40°C to +105°C
Storage Temperature Range	-65°C to +150°C
Junction Temperature (T_J max)	150°C
Power Dissipation	$(T_J \text{ max} - T_A)/\theta_{JA}$
LFCSP_WD Package (4-Layer Board)	
θ_{JA} Thermal Impedance	61°C/W
MSOP Package (4-Layer Board)	
θ_{JA} Thermal Impedance	142°C/W
θ_{JC} Thermal Impedance	43.7°C/W
Reflow Soldering Peak Temperature	
Pb-Free	260°C \pm 5°C

Stresses at or above those listed under Absolute Maximum Ratings may cause permanent damage to the product. This is a stress rating only; functional operation of the product at these or any other conditions above those indicated in the operational section of this specification is not implied. Operation beyond the maximum operating conditions for extended periods may affect product reliability.

ESD CAUTION



ESD (electrostatic discharge) sensitive device. Charged devices and circuit boards can discharge without detection. Although this product features patented or proprietary protection circuitry, damage may occur on devices subjected to high energy ESD. Therefore, proper ESD precautions should be taken to avoid performance degradation or loss of functionality.

PIN CONFIGURATION AND FUNCTION DESCRIPTIONS

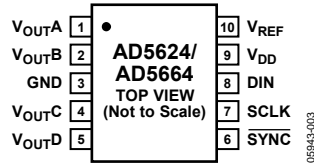
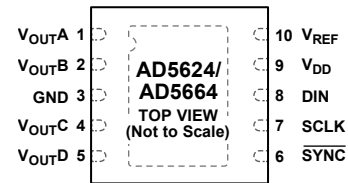

Figure 3. 10-Lead MSOP Pin Configuration



NOTES

1. EXPOSED PAD TIED TO GND ON LFCSP PACKAGE.

Figure 4. 10-Lead LFCSP Pin Configuration

Table 6. Pin Function Descriptions

Pin No.	Mnemonic	Description
1	V _{OUTA}	Analog Output Voltage from DAC A. The output amplifier has rail-to-rail operation.
2	V _{OUTB}	Analog Output Voltage from DAC B. The output amplifier has rail-to-rail operation.
3	GND	Ground Reference Point for All Circuitry on the device
4	V _{OUTC}	Analog Output Voltage from DAC C. The output amplifier has rail-to-rail operation.
5	V _{OUTD}	Analog Output Voltage from DAC D. The output amplifier has rail-to-rail operation.
6	SYNC	Active Low Control Input. This is the frame synchronization signal for the input data. When SYNC goes low, it powers on the SCLK and DIN buffers and enables the input shift register. Data is transferred in on the falling edges of the next 24 clocks. If SYNC is taken high before the 24 th falling edge, the rising edge of SYNC acts as an interrupt and the write sequence is ignored by the device.
7	SCLK	Serial Clock Input. Data is clocked into the input shift register on the falling edge of the serial clock input. Data can be transferred at rates up to 50 MHz.
8	DIN	Serial Data Input. This device has a 24-bit input shift register. Data is clocked into the register on the falling edge of the serial clock input.
9	V _{DD}	Power Supply Input. These devices can be operated from 2.7 V to 5.5 V. The supply is decoupled with a 10 μF capacitor in parallel with a 0.1 μF capacitor to GND.
10	V _{REF} EPAD	Reference Voltage Input. Exposed Pad. Exposed pad tied to GND on LFCSP package.

TYPICAL PERFORMANCE CHARACTERISTICS

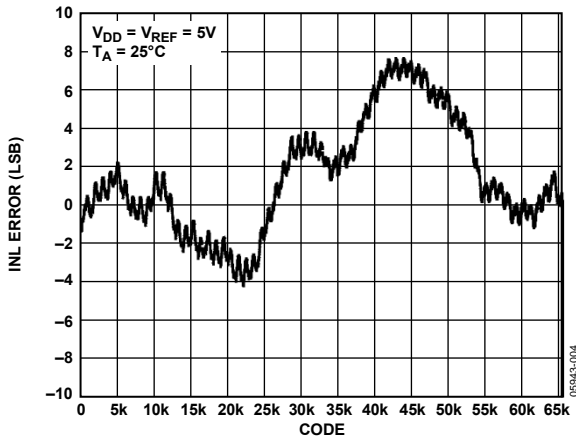

Figure 5. INL AD5664

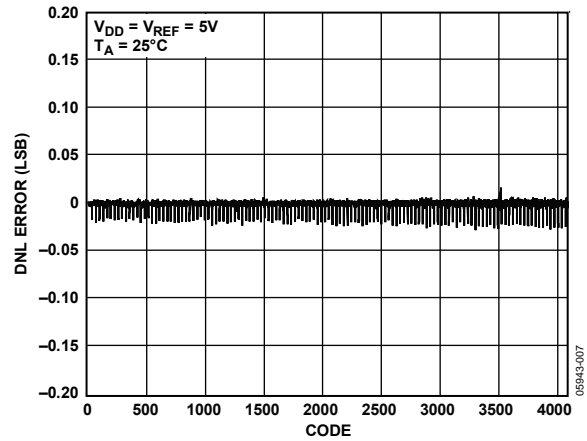

Figure 8. DNL AD5624

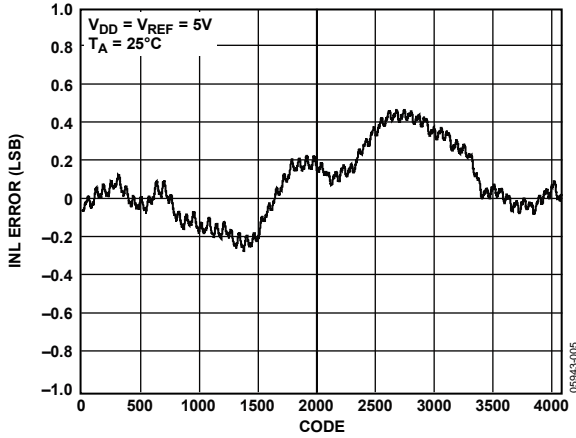

Figure 6. INL AD5624

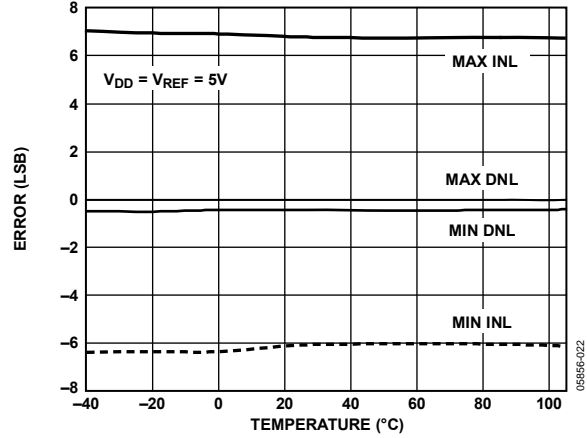

Figure 9. INL Error and DNL Error vs. Temperature

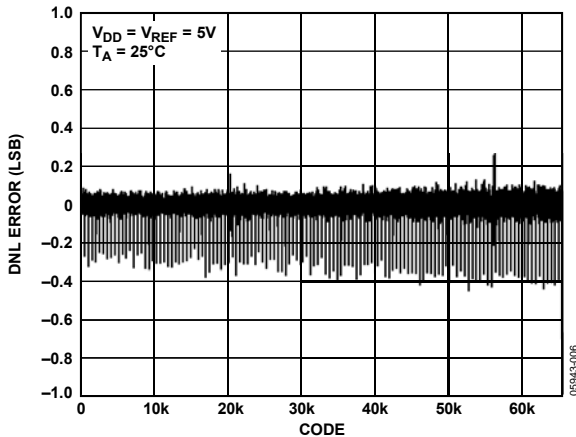

Figure 7. DNL AD5664

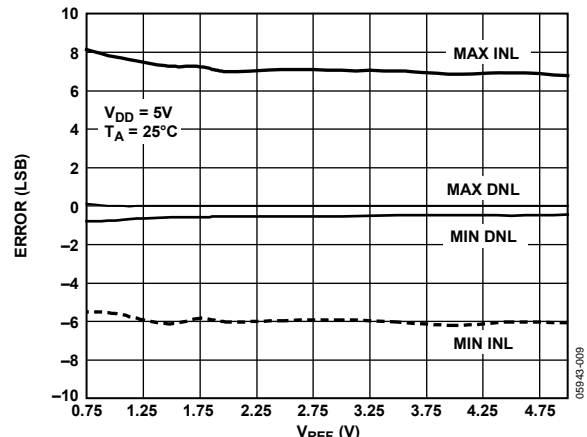

Figure 10. INL and DNL Error vs. VREF

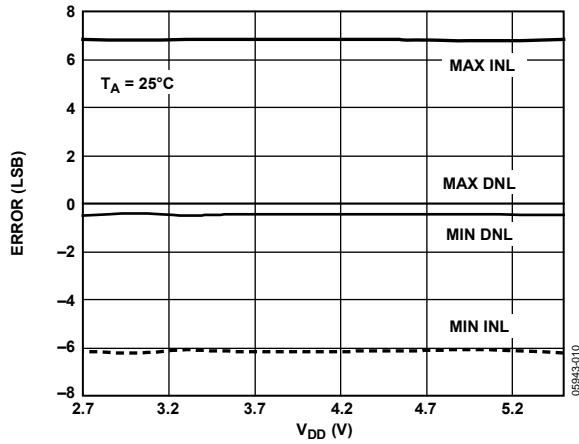

Figure 11. INL and DNL Error vs. Supply

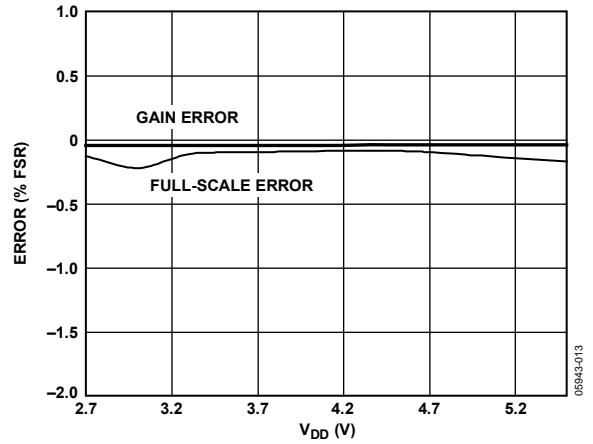

Figure 14. Gain Error and Full-Scale Error vs. Supply

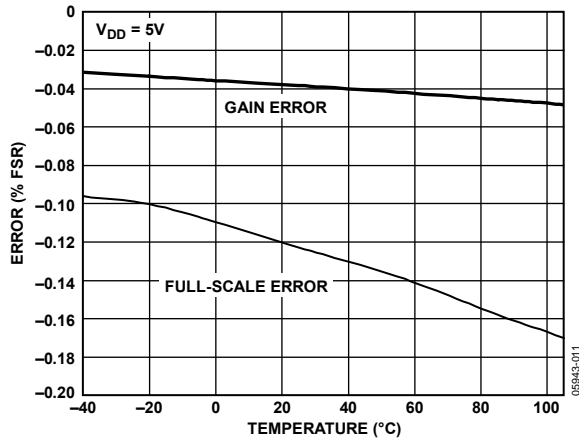

Figure 12. Gain Error and Full-Scale Error vs. Temperature

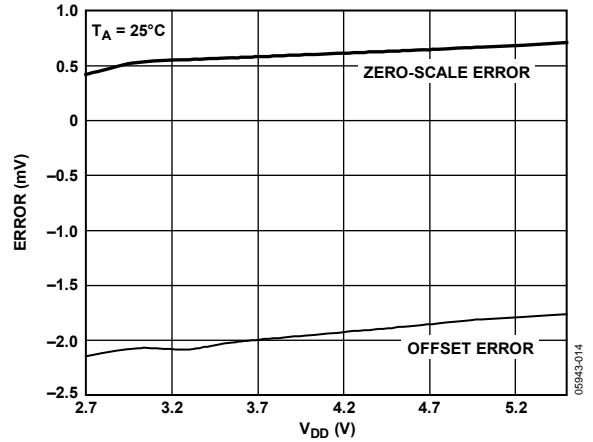

Figure 15. Zero-Scale Error and Offset Error vs. Supply

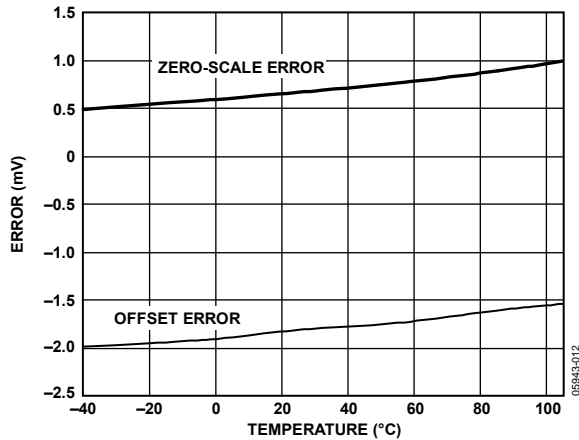

Figure 13. Zero-Scale Error and Offset Error vs. Temperature

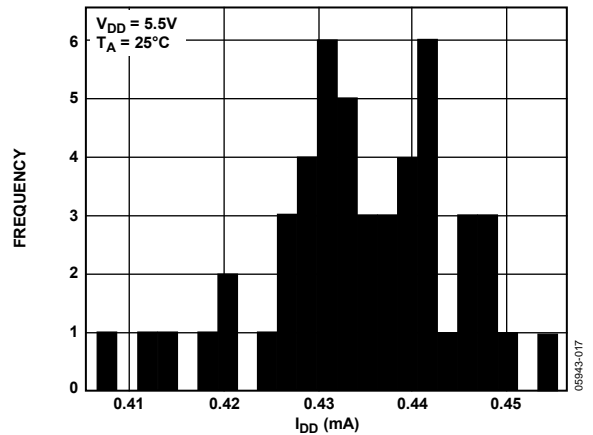

Figure 16. I_{DD} Histogram with $V_{DD} = 5.5 V$

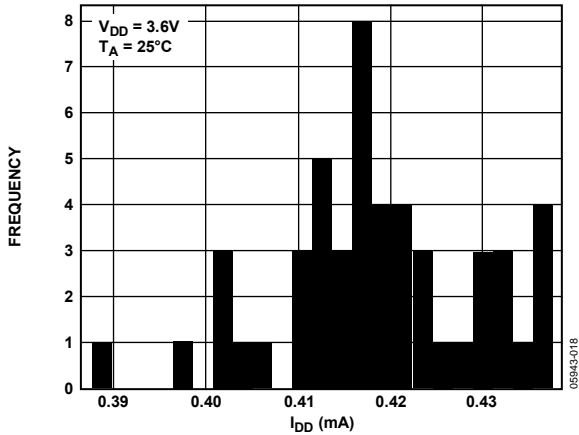

Figure 17. I_{DD} Histogram with $V_{DD} = 3.6V$

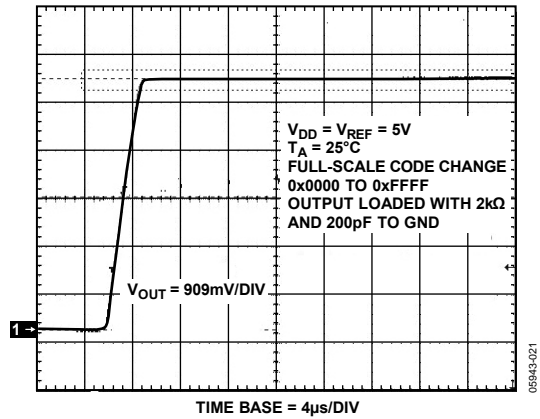

Figure 20. Full-Scale Settling Time, 5V

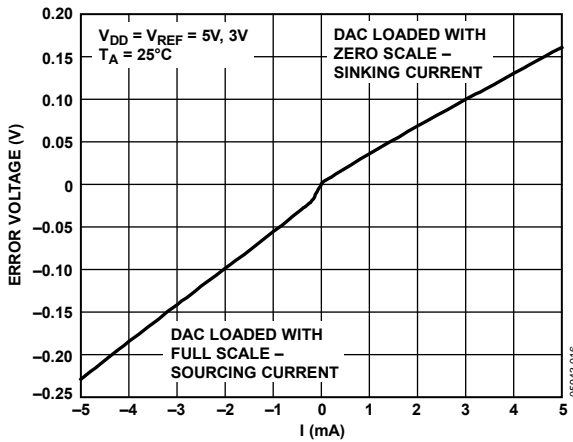

Figure 18. Headroom at Rails vs. Source and Sink Current

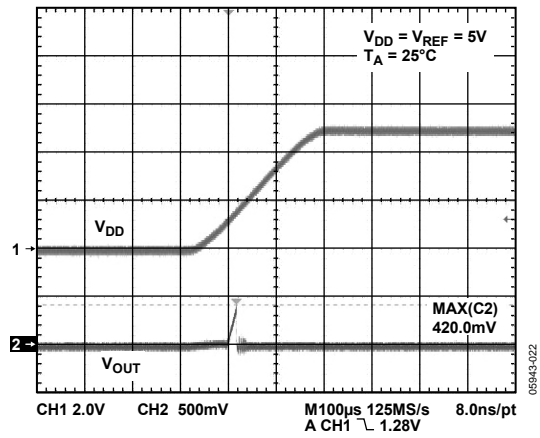

Figure 21. Power-On Reset to 0V

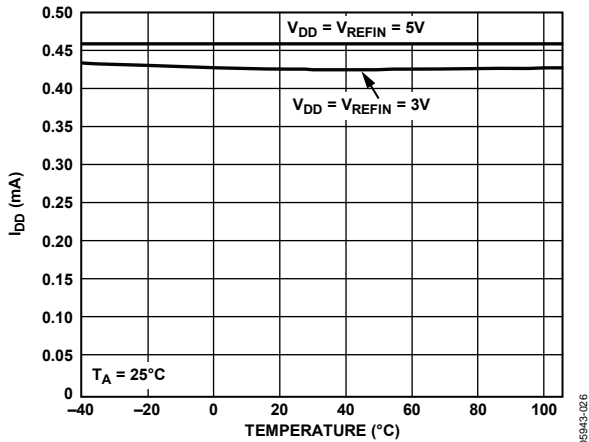

Figure 19. Supply Current vs. Temperature

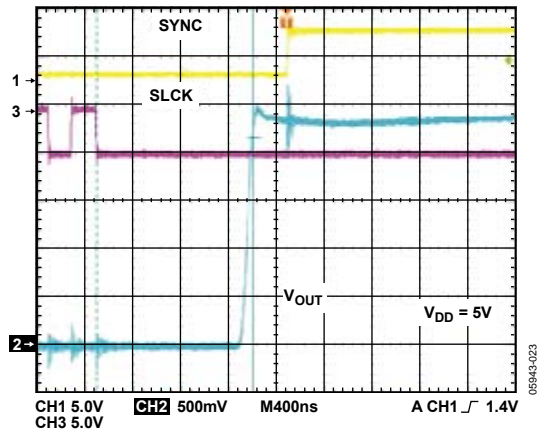

Figure 22. Exiting Power-Down to Midscale

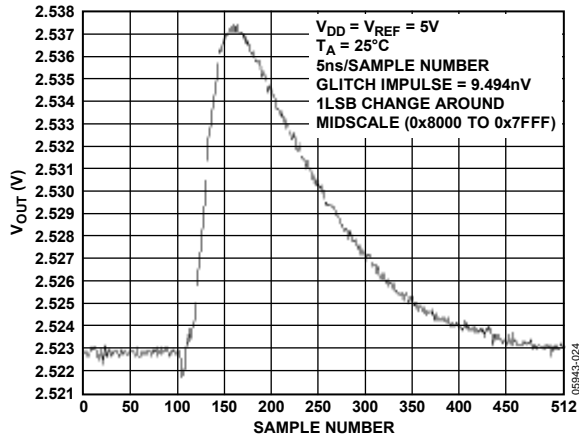

Figure 23. Digital-to-Analog Glitch Impulse (Negative)

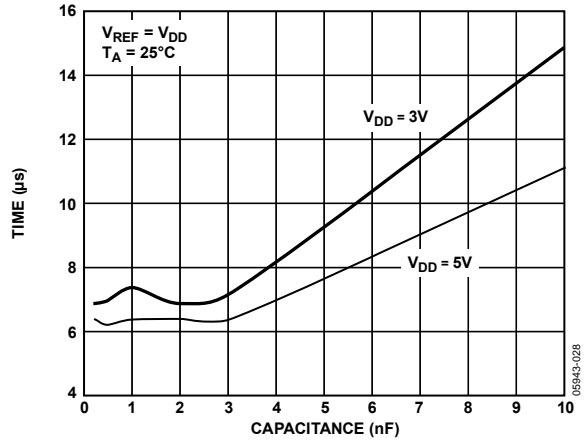

Figure 26. Settling Time vs. Capacitive Load

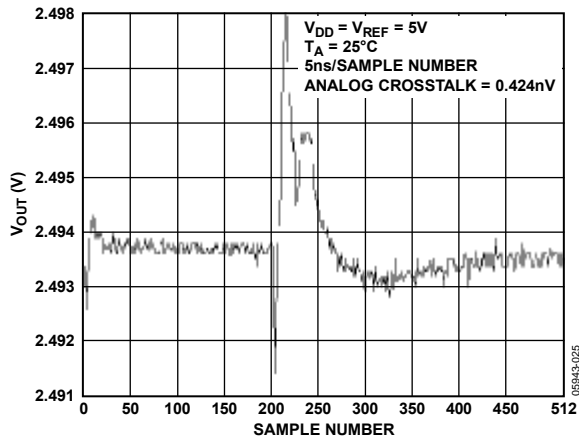

Figure 24. Analog Crosstalk

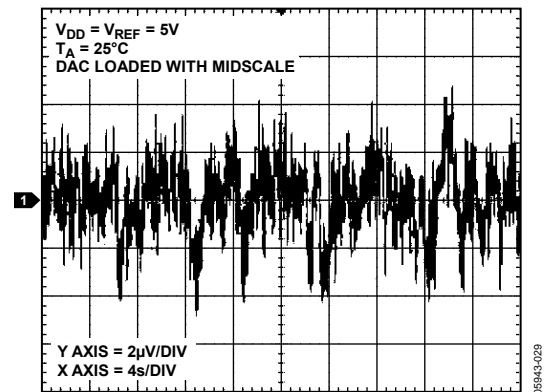

Figure 27. 0.1 Hz to 10 Hz Output Noise Plot

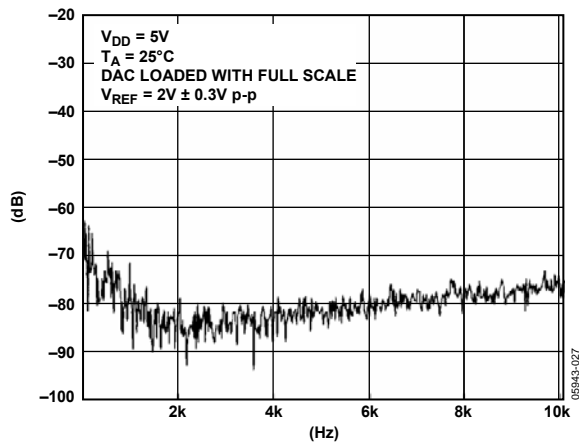

Figure 25. Total Harmonic Distortion

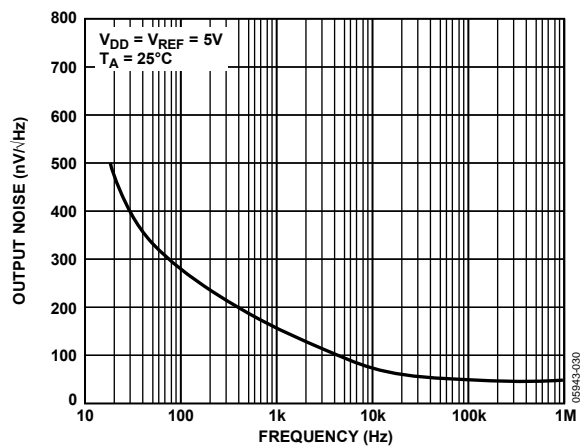

Figure 28. Noise Spectral Density

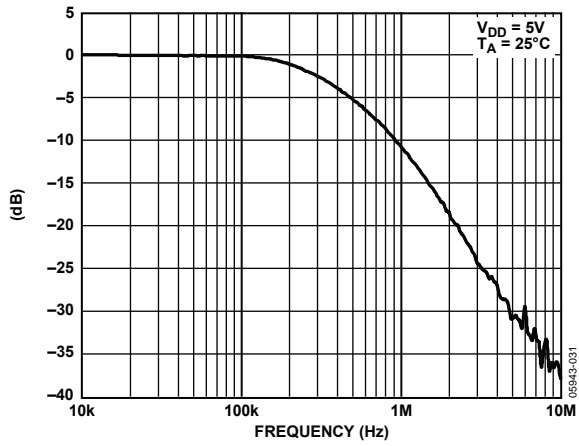

Figure 29. Multiplying Bandwidth

TERMINOLOGY

Relative Accuracy or Integral Nonlinearity (INL)

For the DAC, relative accuracy or integral nonlinearity is a measurement of the maximum deviation, in LSBs, from a straight line passing through the endpoints of the DAC transfer function. A typical INL vs. code plot can be seen in Figure 5 and Figure 6.

Differential Nonlinearity (DNL)

Differential nonlinearity is the difference between the measured change and the ideal 1 LSB change between any two adjacent codes. A specified differential nonlinearity of ± 1 LSB maximum ensures monotonicity. This DAC is guaranteed monotonic by design. A typical DNL vs. code plot can be seen in Figure 7 and Figure 8.

Zero-Scale Error

Zero-scale error is a measurement of the output error when zero code (0x0000) is loaded to the DAC register. Ideally, the output is 0 V. The zero code error is always positive in the AD5624/AD5664 because the output of the DAC cannot go below 0 V. It is due to a combination of the offset errors in the DAC and the output amplifier. Zero code error is expressed in mV. A plot of zero code error vs. temperature can be seen in Figure 13.

Full-Scale Error

Full-scale error is a measurement of the output error when full-scale code (0xFFFF) is loaded to the DAC register. Ideally, the output is $V_{DD} - 1$ LSB. Full-scale error is expressed in % of FSR. A plot of full-scale error vs. temperature can be seen in Figure 12.

Gain Error

This is a measure of the span error of the DAC. It is the deviation in slope of the DAC transfer characteristic from ideal expressed as a % of FSR.

Zero Code Error Drift

This is a measurement of the change in zero code error with a change in temperature. It is expressed in $\mu\text{V}/^\circ\text{C}$.

Gain Temperature Coefficient

This is a measurement of the change in gain error with changes in temperature. It is expressed in ppm of FSR/ $^\circ\text{C}$.

Offset Error

Offset error is a measure of the difference between V_{OUT} (actual) and V_{OUT} (ideal) expressed in mV in the linear region of the transfer function. Offset error is measured on the AD5624/AD5664 with code 512 loaded in the DAC register. It can be negative or positive.

DC Power Supply Rejection Ratio (PSRR)

This indicates how the output of the DAC is affected by changes in the supply voltage. PSRR is the ratio of the change in V_{OUT} to a change in V_{DD} for full-scale output of the DAC. It is measured in dB. V_{REF} is held at 2 V, and V_{DD} is varied by $\pm 10\%$.

Output Voltage Settling Time

This is the amount of time it takes for the output of a DAC to settle to a specified level for a $\frac{1}{4}$ to $\frac{3}{4}$ full-scale input change and is measured from the 24th falling edge of SCLK.

Digital-to-Analog Glitch Impulse

Digital-to-analog glitch impulse is the impulse injected into the analog output when the input code in the DAC register changes state. It is normally specified as the area of the glitch in nV-s, and is measured when the digital input code is changed by 1 LSB at the major carry transition (0x7FFF to 0x8000) as shown in Figure 23.

Digital Feedthrough

Digital feedthrough is a measure of the impulse injected into the analog output of the DAC from the digital inputs of the DAC, but is measured when the DAC output is not updated. It is specified in nV-s, and measured with a full-scale code change on the data bus, that is, from all 0s to all 1s and vice versa.

Total Harmonic Distortion (THD)

This is the difference between an ideal sine wave and its attenuated version using the DAC. The sine wave is used as the reference for the DAC, and the THD is a measurement of the harmonics present on the DAC output. It is measured in dB.

Noise Spectral Density

This is a measurement of the internally generated random noise. Random noise is characterized as a spectral density ($\text{nV}/\sqrt{\text{Hz}}$). It is measured by loading the DAC to midscale and measuring noise at the output. It is measured in $\text{nV}/\sqrt{\text{Hz}}$. A plot of noise spectral density can be seen in Figure 28.

DC Crosstalk

DC crosstalk is the dc change in the output level of one DAC in response to a change in the output of another DAC. It is measured with a full-scale output change on one DAC (or soft power-down and power-up) while monitoring another DAC kept at midscale. It is expressed in μV .

DC crosstalk due to load current change is a measure of the impact that a change in load current on one DAC has to another DAC kept at midscale. It is expressed in $\mu\text{V}/\text{mA}$.

Digital Crosstalk

This is the glitch impulse transferred to the output of one DAC at midscale in response to a full-scale code change (all 0s to all 1s and vice versa) in the input register of another DAC. It is measured in standalone mode and is expressed in nV-s.

Analog Crosstalk

This is the glitch impulse transferred to the output of one DAC due to a change in the output of another DAC. It is measured by loading one of the input registers with a full-scale code change (all 0s to all 1s and vice versa). Then execute a software LDAC and monitor the output of the DAC whose digital code was not changed. The area of the glitch is expressed in nV-s (see Figure 24).

DAC-to-DAC Crosstalk

This is the glitch impulse transferred to the output of one DAC due to a digital code change and subsequent analog output change of another DAC. It is measured by loading the attack channel with a full-scale code change (all 0s to all 1s and vice versa) using the command write to and update while monitoring the output of the victim channel that is at midscale. The energy of the glitch is expressed in nV-s.

Multiplying Bandwidth

The amplifiers within the DAC have a finite bandwidth. The multiplying bandwidth is a measure of this. A sine wave on the reference (with full-scale code loaded to the DAC) appears on the output. The multiplying bandwidth is the frequency at which the output amplitude falls to 3 dB below the input.

THEORY OF OPERATION

D/A SECTION

The AD5624/AD5664 DACs are fabricated on a CMOS process. The architecture consists of a string DAC followed by an output buffer amplifier. Figure 30 shows a block diagram of the DAC architecture.

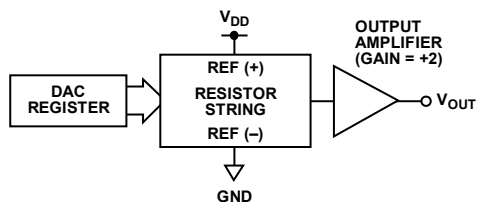

Figure 30. DAC Architecture

Since the input coding to the DAC is straight binary, the ideal output voltage is given by

$$V_{OUT} = V_{REFIN} \times \left(\frac{D}{2^N} \right)$$

where:

D is the decimal equivalent of the binary code that is loaded to the DAC register:

0 to 4095 for AD5624 (12 bit).

0 to 65535 for AD5664 (16 bit).

N is the DAC resolution.

RESISTOR STRING

The resistor string is shown in Figure 31. It is simply a string of resistors, each of value R . The code loaded to the DAC register determines at which node on the string the voltage is tapped off to be fed into the output amplifier. The voltage is tapped off by closing one of the switches connecting the string to the amplifier. Because it is a string of resistors, it is guaranteed monotonic.

OUTPUT AMPLIFIER

The output buffer amplifier can generate rail-to-rail voltages on its output, which gives an output range of 0 V to V_{DD} . It can drive a load of 2 k Ω in parallel with 1000 pF to GND. The source and sink capabilities of the output amplifier can be seen in Figure 18. The slew rate is 1.8 V/ μ s with a $\frac{1}{4}$ to $\frac{3}{4}$ full-scale settling time of 7 μ s.

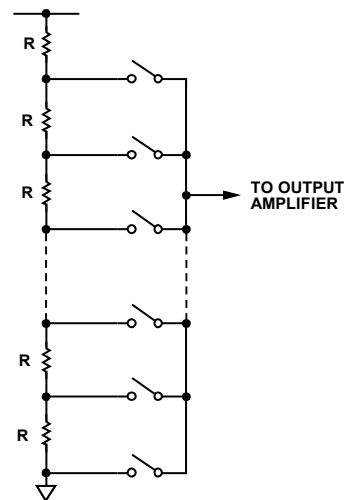

Figure 31. Resistor String

SERIAL INTERFACE

The AD5624/AD5664 have a 3-wire serial interface ($\overline{\text{SYNC}}$, SCLK, and DIN) that is compatible with SPI, QSPI, and MICROWIRE interface standards as well as with most DSPs. See Figure 2 for a timing diagram of a typical write sequence.

The write sequence begins by bringing the $\overline{\text{SYNC}}$ line low. Data from the DIN line is clocked into the 24-bit shift register on the falling edge of SCLK. The serial clock frequency can be as high as 50 MHz, making the AD5624/AD5664 compatible with high speed DSPs. On the 24th falling clock edge, the last data bit is clocked in and the programmed function is executed, that is, a change in DAC register contents and/or a change in the mode of operation. At this stage, the $\overline{\text{SYNC}}$ line can be kept low or be brought high. In either case, it must be brought high for a minimum of 15 ns before the next write sequence so that a falling edge of $\overline{\text{SYNC}}$ can initiate the next write sequence. Because the $\overline{\text{SYNC}}$ buffer draws more current when $V_{IN} = 2.0$ V than it does when $V_{IN} = 0.8$ V, $\overline{\text{SYNC}}$ is idled low between write sequences for even lower power operation. It must, however, be brought high again just before the next write sequence.

INPUT SHIFT REGISTER

The input shift register is 24 bits wide. The first two bits are don't care bits. The next three bits are the Command bits, C2 to C0 (see Table 7), followed by the 3-bit DAC address, A2 to A0 (see Table 8), and then the 16-, 12-bit data-word. The data-word comprises the 16-, 12-bit input code followed by 0 or 4 don't care bits for the AD5664 and AD5624 respectively (see Figure 32 and Figure 33). These data bits are transferred to the DAC register on the 24th falling edge of SCLK.

Table 7. Command Definition

C2	C1	C0	Command
0	0	0	Write to input register <i>n</i>
0	0	1	Update DAC register <i>n</i>
0	1	0	Write to input register <i>n</i> , update all (software LDAC)
0	1	1	Write to and update DAC channel <i>n</i>
1	0	0	Power down DAC (power-up)
1	0	1	Reset
1	1	0	Load LDAC register
1	1	1	Reserved

Table 8. Address Command

A2	A1	A0	ADDRESS (<i>n</i>)
0	0	0	DAC A
0	0	1	DAC B
0	1	0	DAC C
0	1	1	DAC D
1	1	1	All DACs

SYNC INTERRUPT

In a normal write sequence, the $\overline{\text{SYNC}}$ line is kept low for at least 24 falling edges of SCLK, and the DAC is updated on the 24th falling edge. However, if $\overline{\text{SYNC}}$ is brought high before the 24th falling edge, then this acts as an interrupt to the write sequence. The input shift register is reset and the write sequence is seen as invalid. Neither an update of the DAC register contents nor a change in the operating mode occurs (see Figure 34).

POWER-ON RESET

The AD5624/AD5664 family contains a power-on reset circuit that controls the output voltage during power-up. The AD5624/AD5664 DAC outputs power up to 0 V and the output remains there until a valid write sequence is made to the DAC. This is useful in applications where it is important to know the state of the output of the DAC while it is in the process of powering up.

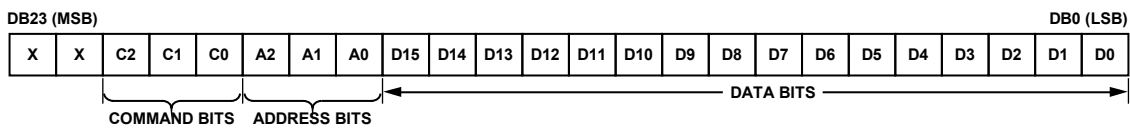

Figure 32. AD5664 Input Shift Register Contents

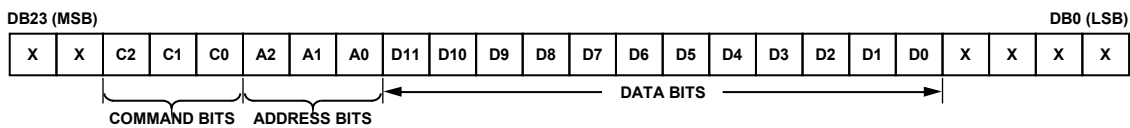

Figure 33. AD5624 Input Shift Register Contents

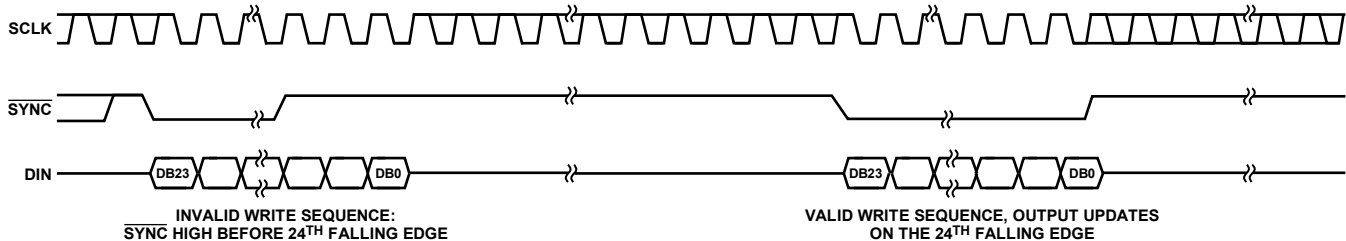

Figure 34. $\overline{\text{SYNC}}$ Interrupt Facility

SOFTWARE RESET

The AD5624/AD5664 contain a software reset function. Command 110 is reserved for the software reset function (see Table 7). The software reset command contains two reset modes that are software programmable by setting Bit DB0 in the control register. Table 9 shows how the state of the bit corresponds to the software reset modes of operation of the devices.

Table 9. Software Reset Modes for the AD5624/AD5664

DB0	Registers Reset to Zero
0	DAC register Input shift register
1 (Power-On Reset)	DAC register Input shift register LDAC register Power-down register

POWER-DOWN MODES

The AD5624/AD5664 contain four separate modes of operation. Command 100 is reserved for the power-down function (see Table 7). These modes are software programmable by setting two bits (DB5 and DB4) in the control register. Table 10 shows how the state of the bits corresponds to the mode of operation of the device. All DACs (DAC D to DAC A) can be powered down to the selected mode by setting the corresponding four bits (DB3, DB2, DB1, and DB0) to 1. By executing the same Command 100, any combination of DACs is powered up by setting Bit DB5 and Bit DB4 to normal operation mode. To select which combination of DAC channels to power-up, set the corresponding four bits (DB3, DB2, DB1, and DB0) to 1. See Table 11 for contents of the input shift register during the power-down/power-up operation.

Table 10. Modes of Operation for the AD5624/AD5664

DB5	DB4	Operating Mode
0	0	Normal operation Power-down modes
0	1	1 kΩ to GND
1	0	100 kΩ to GND
1	1	Three-state

When both bits are set to 0, the devices work normally with their normal power consumption of 450 μA at 5 V. However, for the three power-down modes, the supply current falls to 480 nA at 5 V (200 nA at 3 V). Not only does the supply current fall, but the output stage is also internally switched from the output of the amplifier to a resistor network of known values. This allows the output impedance of the device to be known while the device is in power-down mode.

The outputs can either be connected internally to GND through a 1 kΩ or 100 kΩ resistor, or left open circuited (three-state) (see Figure 35).

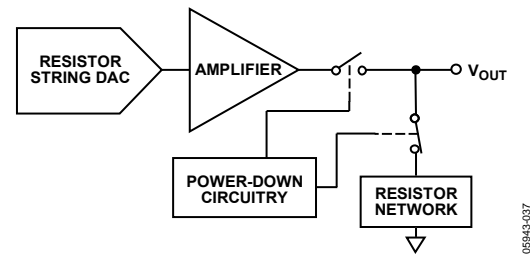

Figure 35. Output Stage During Power-Down

The bias generator, the output amplifier, the resistor string, and other associated linear circuitry are shut down when power-down mode is activated. However, the contents of the DAC register are unaffected when in power-down. The time to exit power-down is typically 4 μs for V_{DD} = 5 V and for V_{DD} = 3 V (see Figure 22).

Table 11. 24-Bit Input Shift Register Contents of Power-Down/Power-Up Operation

DB23 to DB22 (MSB)	DB21	DB20	DB19	DB18	DB17	DB16	DB15 to DB6	DB5	DB4	DB3	DB2	DB1	DB0 (LSB)
x	1	0	0	x	x	x	x	PD1	PD0	DAC D	DAC C	DAC B	DAC A
Don't care	Command bits (C2 to C0)			Address bits (A2 to A0); don't care			Don't care	Power-down mode		Power-down/power-up channel selection, set bit to 1 to select channel			

LDAC FUNCTION

The AD5624/AD5664 DACs have double buffered interfaces consisting of two banks of registers: input registers and DAC registers. The input registers are connected directly to the input shift register and the digital code is transferred to the relevant input register on completion of a valid write sequence. The DAC registers contain the digital code used by the resistor strings.

The double buffered interface is useful if the user requires simultaneous updating of all DAC outputs. The user can write to three of the input registers individually and then write to the remaining input register and update all DAC registers, the outputs update simultaneously. Command 010 is reserved for this software LDAC.

Access to the DAC registers is controlled by the LDAC function. The LDAC registers contain two modes of operation for each DAC channel. The DAC channels are selected by setting the bits of the 4-bit LDAC register (DB3, DB2, DB1, and DB0). Command 110 is reserved for setting up the LDAC register. When the LDAC bit register is set low, the corresponding DAC registers are latched and the input registers can change state without affecting the contents of the

DAC registers. When the LDAC bit register is set high, however, the DAC registers become transparent and the contents of the input registers are transferred to them on the falling edge of the 24th SCLK pulse. This is equivalent to having an LDAC hardware pin tied permanently low for the selected DAC channel, that is, synchronous update mode. See Table 12 for the LDAC register mode of operation. See Table 13 for contents of the input shift register during the LDAC register set up command.

This flexibility is useful in applications where the user wants to update select channels simultaneously, while the rest of the channels update synchronously.

Table 12. LDAC Register Mode of Operation

Load DAC Register	
LDAC Bits (DB3 to DB0)	LDAC Mode of Operation
0	Normal operation (default), DAC register update is controlled by write command.
1	The DAC registers are updated after new data is read in on the falling edge of the 24 th SCLK pulse.

Table 13. 24-Bit Input Shift Register Contents for LDAC Setup Command for the AD5624/AD5664

DB23 to DB22 (MSB)	DB21	DB20	DB19	DB18	DB17	DB16	DB15 to DB4	DB3	DB2	DB1	DB0 (LSB)
x	1	1	0	x	x	x	x	DACD	DACC	DACB	DACA
Don't care	Command bits (C2 to C0)			Address bits (A3 to A0); don't care			Don't care	Set bit to 0 or 1 for required mode of operation on respective channel			

MICROPROCESSOR INTERFACING

AD5624/AD5664 to Blackfin® ADSP-BF53x Interface

Figure 36 shows a serial interface between the AD5624/AD5664 and the Blackfin ADSP-BF53x microprocessor. The ADSP-BF53x processor family incorporates two dual channel synchronous serial ports, SPORT1 and SPORT0, for serial and multiprocessor communications. Using SPORT0 to connect to the AD5624/AD5664, the setup for the interface is as follows. DTOPRI drives the DIN pin of the AD5624/AD5664, while TSCLK0 drives the SCLK of the device. The SYNC is driven from TFS0.

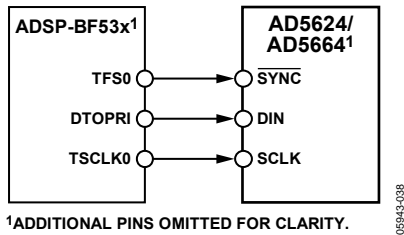

Figure 36. Blackfin ADSP-BF53x Interface to AD5624/AD5664

AD5624/AD5664 to 68HC11/68L11 Interface

Figure 37 shows a serial interface between the AD5624/AD5664 and the 68HC11/68L11 microcontroller. SCK of the 68HC11/68L11 drives the SCLK of the AD5624/AD5664, while the MOSI output drives the serial data line of the DAC.

The SYNC signal is derived from a port line (PC7). The setup conditions for correct operation of this interface are as follows. The 68HC11/68L11 is configured with its CPOL bit as a 0 and its CPHA bit as a 1. When data is being transmitted to the DAC, the SYNC line is taken low (PC7). When the 68HC11/68L11 is configured as described previously, data appearing on the MOSI output is valid on the falling edge of SCK. Serial data from the 68HC11/68L11 is transmitted in 10-bit bytes with only eight falling clock edges occurring in the transmit cycle. Data is transmitted MSB first. To load data to the AD5624/AD5664, PC7 is left low after the first eight bits are transferred, and a second serial write operation is performed to the DAC; PC7 is taken high at the end of this procedure.

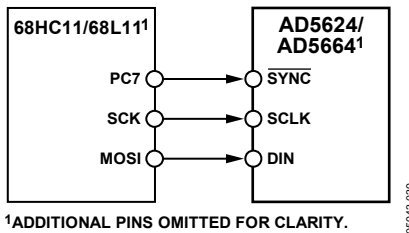

Figure 37. 68HC11/68L11 Interface to AD5624/AD5664

AD5624/AD5664 to 80C51/80L51 Interface

Figure 38 shows a serial interface between the AD5624/AD5664 and the 80C51/80L51 microcontroller. The setup for the interface is as follows. TxD of the 80C51/80L51 drives SCLK of the AD5624/AD5664, while RxD drives the serial data line of the device. The SYNC signal is derived from a bit-programmable pin on the port. In this case, port line P3.3 is used. When data is transmitted to the AD5624/AD5664, P3.3 is taken low. The 80C51/80L51 transmits data in 10-bit bytes only; thus only eight falling clock edges occur in the transmit cycle. To load data to the DAC, P3.3 is left low after the first eight bits are transmitted, and a second write cycle is initiated to transmit the second byte of data. P3.3 is taken high following the completion of this cycle. The 80C51/80L51 output the serial data in a format that has the LSB first. The AD5624/AD5664 must receive data with the MSB first. The 80C51/80L51 transmit routine takes this into account.

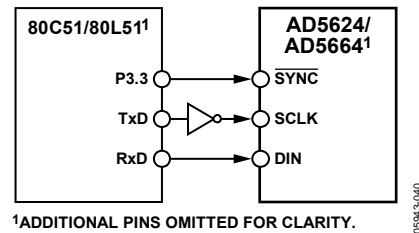

Figure 38. 80C51/80L51 Interface to AD5624/AD5664

AD5624/AD5664 to MICROWIRE Interface

Figure 39 shows an interface between the AD5624/AD5664 and any MICROWIRE-compatible device. Serial data is shifted out on the falling edge of the serial clock and is clocked into the AD5624/AD5664 on the rising edge of the SK.

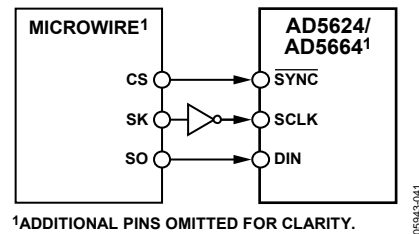

Figure 39. MICROWIRE Interface to AD5624/AD5664

APPLICATIONS INFORMATION

CHOOSING A REFERENCE FOR THE AD5624/AD5664

To achieve the optimum performance from the AD5624/AD5664, give thought to the choice of a precision voltage reference. The AD5624/AD5664 have only one reference input, V_{REF} . The voltage on the reference input is used to supply the positive input to the DAC. Therefore, any error in the reference is reflected in the DAC.

When choosing a voltage reference for high accuracy applications, the sources of error are initial accuracy, ppm drift, long term drift, and output voltage noise. Initial accuracy on the output voltage of the DAC leads to a full-scale error in the DAC. To minimize these errors, a reference with high initial accuracy is preferred. Choosing a reference with an output trim adjustment, such as the ADR423, allows a system designer to trim out system errors by setting a reference voltage to a voltage other than the nominal. The trim adjustment can also be used at temperature to trim out any error.

Long term drift is a measurement of how much the reference drifts over time. A reference with a tight long-term drift specification ensures that the overall solution remains relatively stable during its entire lifetime.

The temperature coefficient of a reference's output voltage affects INL, DNL, and TUE. Choose a reference with a tight temperature coefficient specification to reduce temperature dependence of the DAC output voltage in ambient conditions.

In high accuracy applications, which have a relatively low noise budget, reference output voltage noise needs to be considered. It is important to choose a reference with as low an output noise voltage as practical for the system noise resolution required. Precision voltage references such as the ADR425 produce low output noise in the 0.1 Hz to 10 Hz range. Examples of recommended precision references for use as supply to the AD5624/AD5664 are shown in the Table 14.

Table 14. Partial List of Precision References for Use with the AD5624/AD5664

Part No.	Initial Accuracy (mV max)	Temp Drift (ppm/°C max)	0.1 Hz to 10 Hz Noise (μV p-p typ)	V_{OUT} (V)
ADR425	± 2	3	3.4	5
ADR395	± 6	25	5	5
REF195	± 2	5	50	5
AD780	± 2	3	4	2.5/3
ADR423	± 2	3	3.4	3

USING A REFERENCE AS A POWER SUPPLY FOR THE AD5624/AD5664

Because the supply current required by the AD5624/AD5664 is extremely low, an alternative option is to use a voltage reference to supply the required voltage to the device (see Figure 40). This is especially useful if the power supply is quite noisy, or if the system supply voltages are at some value other than 5 V or 3 V, for example, 15 V. The voltage reference outputs a steady supply voltage for the AD5624/AD5664 (see Table 14 for a suitable reference). If the low dropout REF195 is used, it must supply 450 μA of current to the AD5624/AD5664, with no load on the output of the DAC. When the DAC output is loaded, the REF195 also needs to supply the current to the load. The total current required (with a 5 k Ω load on the DAC output) is

$$450 \mu\text{A} + (5 \text{ V} / 5 \text{ k}\Omega) = 1.45 \text{ mA}$$

The load regulation of the REF195 is typically 2 ppm/mA, which results in a 2.9 ppm (14.5 μV) error for the 1.45 mA current drawn from it. This corresponds to a 0.191 LSB error.

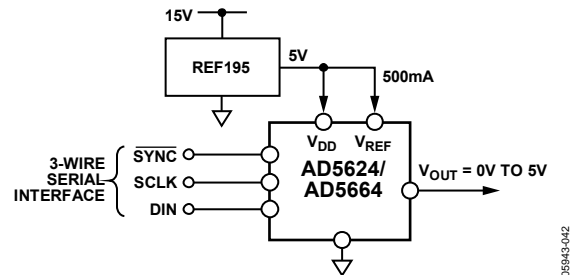

Figure 40. REF195 as Power Supply to the AD5624/AD5664

BIPOLAR OPERATION USING THE AD5624/AD5664

The AD5624/AD5664 have been designed for single supply operation, but a bipolar output range is also possible using the circuit in Figure 41. The circuit gives an output voltage range of ± 5 V. Rail-to-rail operation at the amplifier output is achievable using an AD820 or an OP295 as the output amplifier.

The output voltage for any input code can be calculated as follows:

$$V_O = \left[V_{DD} \times \left(\frac{D}{65,536} \right) \times \left(\frac{R1 + R2}{R1} \right) - V_{DD} \times \left(\frac{R2}{R1} \right) \right]$$

where D represents the input code in decimal (0 to 65536). With $V_{DD} = 5$ V, $R1 = R2 = 10$ k Ω ,

$$V_O = \left(\frac{10 \times D}{65,536} \right) - 5$$

This is an output voltage range of ± 5 V, with 0x0000 corresponding to a -5 V output, and 0xFFFF corresponding to a $+5$ V output.

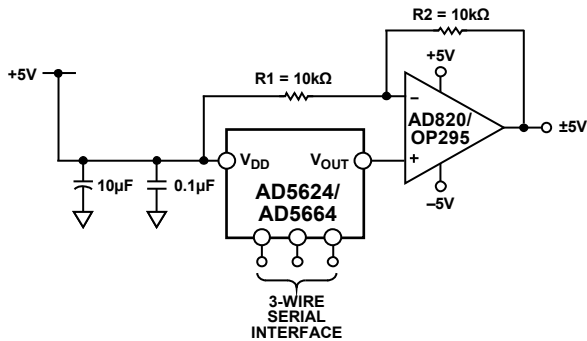

Figure 41. Bipolar Operation with the AD5624/AD5664

USING AD5624/AD5664 WITH A GALVANICALLY ISOLATED INTERFACE

In process control applications in industrial environments, it is often necessary to use a galvanically isolated interface to protect and isolate the controlling circuitry from any hazardous common-mode voltages that might occur in the area where the DAC is functioning. Isocouplers provide isolation in excess of 3 kV. The AD5624/AD5664 use a 3-wire serial logic interface, so the ADuM130x 3-channel digital isolator provides the required isolation (see Figure 42). The power supply to the device also needs to be isolated, which is done by using a transformer. On the DAC side of the transformer, a 5 V regulator provides the 5 V supply required for the AD5624/AD5664.

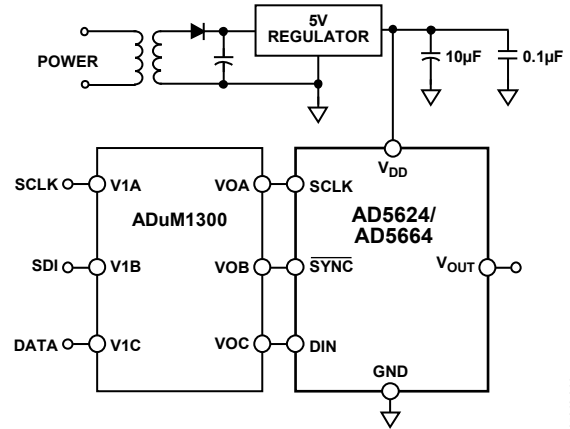

Figure 42. AD5624/AD5664 with a Galvanically Isolated Interface

POWER SUPPLY BYPASSING AND GROUNDING

When accuracy is important in a circuit, it is helpful to consider carefully the power supply and ground return layout on the board. The printed circuit board containing the AD5624/AD5664 has separate analog and digital sections, each having its own area of the board. If the AD5624/AD5664 is in a system where other devices require an AGND-to-DGND connection, make the connection at one point only. This ground point must be as close as possible to the AD5624/AD5664.

The power supply to the AD5624/AD5664 must be bypassed with 10 μ F and 0.1 μ F capacitors. The capacitors must be located as close as possible to the device, with the 0.1 μ F capacitor ideally right up against the device. The 10 μ F capacitor is the tantalum bead type. It is important that the 0.1 μ F capacitor has low effective series resistance (ESR) and effective series inductance (ESI), for example, common ceramic types of capacitors. This 0.1 μ F capacitor provides a low impedance path to ground for high frequencies caused by transient currents due to internal logic switching.

The power supply line itself has as large a trace as possible to provide a low impedance path and to reduce glitch effects on the supply line. Clocks and other fast switching digital signals must be shielded from other parts of the board by digital ground. Avoid crossover of digital and analog signals if possible. When traces cross on opposite sides of the board, ensure they run at right angles to each other to reduce feedthrough effects through the board. The best board layout technique is the microstrip technique where the component side of the board is dedicated to the ground plane only and the signal traces are placed on the solder side. This is not always possible with a 2-layer board.

OUTLINE DIMENSIONS

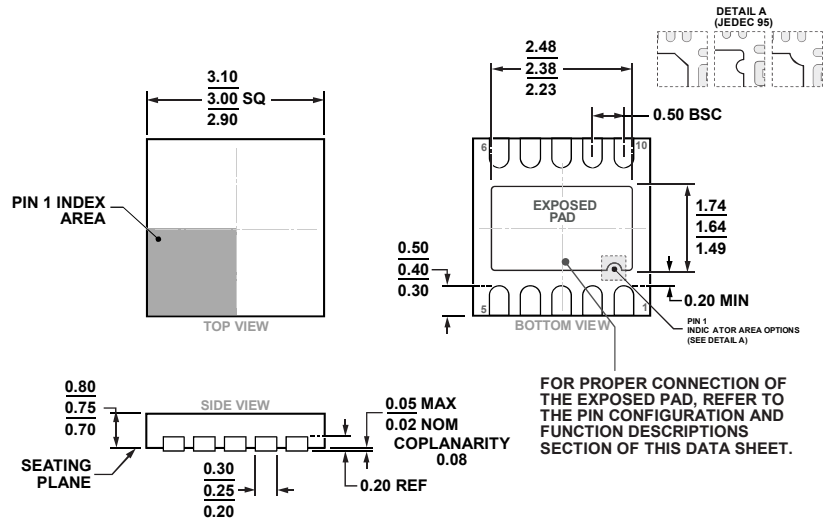
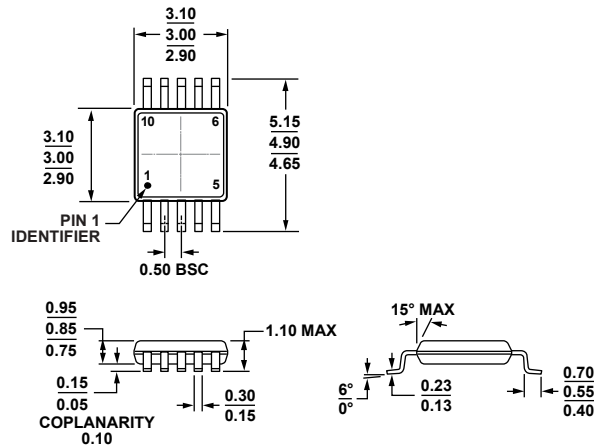

Figure 43. 10-Lead Lead Frame Chip Scale Package [LFCSP]
3 mm x 3 mm Body and 0.75 mm Package Height
(CP-10-9)
Dimensions shown in millimeters



COMPLIANT TO JEDEC STANDARDS MO-187-BA
Figure 44. 10-Lead Mini Small Outline Package [MSOP]
(RM-10)
Dimensions shown in millimeters

ORDERING GUIDE

Model ¹	Temperature Range	Accuracy	Package Description	Package Option	Marking Code
AD5624BRMZ	-40°C to +105°C	±1 LSB INL	10-Lead MSOP	RM-10	D5J
AD5624BRMZ-REEL7	-40°C to +105°C	±1 LSB INL	10-Lead MSOP	RM-10	D5J
AD5624BCPZ-R2	-40°C to +105°C	±1 LSB INL	10-Lead LFCSP	CP-10-9	D5J
AD5624BCPZ-REEL7	-40°C to +105°C	±1 LSB INL	10-Lead LFCSP	CP-10-9	D5J
AD5664ARMZ	-40°C to +105°C	±16 LSB INL	10-Lead MSOP	RM-10	D7C
AD5664ARMZ-REEL7	-40°C to +105°C	±16 LSB INL	10-Lead MSOP	RM-10	D7C
AD5664BRMZ	-40°C to +105°C	±12 LSB INL	10-Lead MSOP	RM-10	D78
AD5664BRMZ-REEL7	-40°C to +105°C	±12 LSB INL	10-Lead MSOP	RM-10	D78
AD5664BCPZ-R2	-40°C to +105°C	±12 LSB INL	10-Lead LFCSP	CP-10-9	D78
AD5664BCPZ-REEL7	-40°C to +105°C	±12 LSB INL	10-Lead LFCSP	CP-10-9	D78

¹ Z = RoHS Complaint Part

Mouser Electronics

Authorized Distributor

Click to View Pricing, Inventory, Delivery & Lifecycle Information:

[Analog Devices Inc.:](#)

[AD5664BCPZ-R2](#) [AD5624BCPZ-R2](#) [AD5664ARMZ](#) [AD5624BRMZ](#) [AD5664BRMZ](#) [AD5624BCPZ-REEL7](#)
[AD5624BRMZ-REEL7](#) [AD5664BCPZ-REEL7](#) [AD5664BRMZ-REEL7](#) [AD5664ARMZ-REEL7](#)