

N-CHANNEL ENHANCEMENT-MODE POWER MOSFET

Low gate-charge
Simple drive requirement
Fast switching

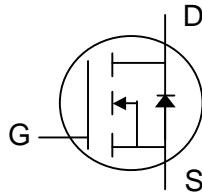

BV_{DSS} 30V
 $R_{DS(ON)}$ 12m Ω
 I_D 45A

Description

The SSM60T03H is in a TO-252 package, which is widely used for commercial and industrial surface mount applications, and is well suited for low voltage applications such as DC/DC converters. The through-hole version, the SSM60T03J in TO-251, is available for low-footprint vertical mounting. These devices are manufactured with an advanced process, providing improved on-resistance and switching performance. The devices have a maximum junction temperature rating of 175°C for improved thermal margin and reliability.

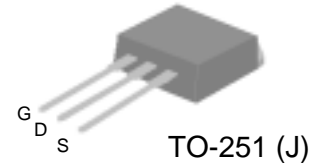
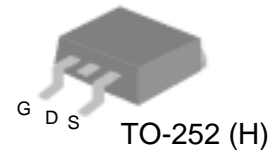

Absolute Maximum Ratings

Symbol	Parameter	Rating	Units
V_{DS}	Drain-Source Voltage	30	V
V_{GS}	Gate-Source Voltage	± 20	V
$I_D @ T_C=25^\circ\text{C}$	Continuous Drain Current, $V_{GS} @ 10\text{V}$	45	A
$I_D @ T_C=100^\circ\text{C}$	Continuous Drain Current, $V_{GS} @ 10\text{V}$	32	A
I_{DM}	Pulsed Drain Current ¹	120	A
$P_D @ T_C=25^\circ\text{C}$	Total Power Dissipation	44	W
	Linear Derating Factor	0.352	W/ $^\circ\text{C}$
E_{AS}	Single Pulse Avalanche Energy ³	29	mJ
T_{STG}	Storage Temperature Range	-55 to 175	$^\circ\text{C}$
T_J	Operating Junction Temperature Range	-55 to 175	$^\circ\text{C}$

Thermal Data

Symbol	Parameter	Max.	Units
Rthj-c	Thermal Resistance Junction-case	3.4	$^\circ\text{C}/\text{W}$
Rthj-a	Thermal Resistance Junction-ambient	110	$^\circ\text{C}/\text{W}$

Electrical Characteristics @ $T_j=25^\circ\text{C}$ (unless otherwise specified)

Symbol	Parameter	Test Conditions	Min.	Typ.	Max.	Units
BV_{DSS}	Drain-Source Breakdown Voltage	$V_{GS}=0V, I_D=250\mu A$	30	-	-	V
$\Delta BV_{DSS}/\Delta T_j$	Breakdown Voltage Temperature Coefficient	Reference to 25°C , $I_D=1\text{mA}$	-	0.026	-	$V/^\circ\text{C}$
$R_{DS(ON)}$	Static Drain-Source On-Resistance ²	$V_{GS}=10V, I_D=20A$	-	-	12	$\text{m}\Omega$
		$V_{GS}=4.5V, I_D=15A$	-	-	25	$\text{m}\Omega$
$V_{GS(th)}$	Gate Threshold Voltage	$V_{DS}=V_{GS}, I_D=250\mu A$	1	-	3	V
g_{fs}	Forward Transconductance ²	$V_{DS}=10V, I_D=10A$	-	25	-	S
I_{DSS}	Drain-Source Leakage Current ($T_j=25^\circ\text{C}$)	$V_{DS}=30V, V_{GS}=0V$	-	-	1	μA
		$V_{DS}=24V, V_{GS}=0V$	-	-	250	μA
I_{GSS}	Gate-Source Leakage	$V_{GS}=\pm 20V$	-	-	± 100	nA
Q_g	Total Gate Charge ²	$I_D=20A$	-	11.6	-	nC
Q_{gs}	Gate-Source Charge	$V_{DS}=24V$	-	3.9	-	nC
Q_{gd}	Gate-Drain ("Miller") Charge	$V_{GS}=4.5V$	-	7	-	nC
$t_{d(on)}$	Turn-on Delay Time ²	$V_{DS}=15V$	-	8.8	-	ns
t_r	Rise Time	$I_D=20A$	-	57.5	-	ns
$t_{d(off)}$	Turn-off Delay Time	$R_G=3.3\Omega, V_{GS}=10V$	-	18.5	-	ns
t_f	Fall Time	$R_D=0.75\Omega$	-	6.4	-	ns
C_{iss}	Input Capacitance	$V_{GS}=0V$	-	1135	-	pF
C_{oss}	Output Capacitance	$V_{DS}=25V$	-	200	-	pF
C_{rss}	Reverse Transfer Capacitance	$f=1.0\text{MHz}$	-	135	-	pF

Source-Drain Diode

Symbol	Parameter	Test Conditions	Min.	Typ.	Max.	Units
V_{SD}	Forward On Voltage ²	$I_S=45A, V_{GS}=0V$	-	-	1.3	V
t_{rr}	Reverse Recovery Time	$I_S=20A, V_{GS}=0V,$	-	23.3	-	ns
Q_{rr}	Reverse Recovery Charge	$dI/dt=100A/\mu s$	-	16	-	nC

Notes:

1. Pulse width limited by safe operating area.
2. Pulse width $\leq 300\mu s$, duty cycle $\leq 2\%$.
3. $V_{DD}=25V$, $L=100\mu H$, $R_G=25\Omega$, $I_{AS}=24A$.

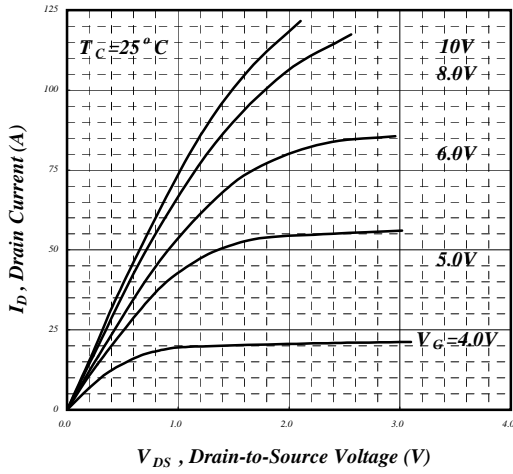

Fig 1. Typical Output Characteristics

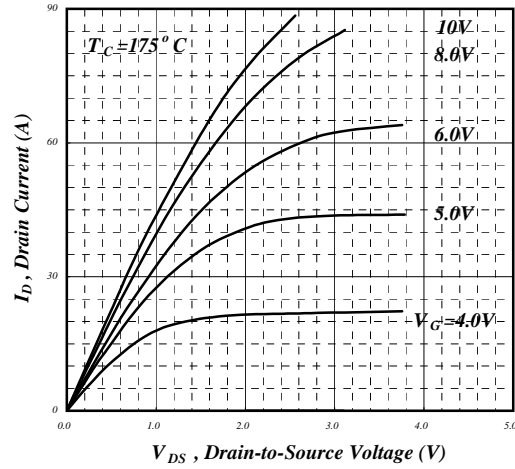

Fig 2. Typical Output Characteristics

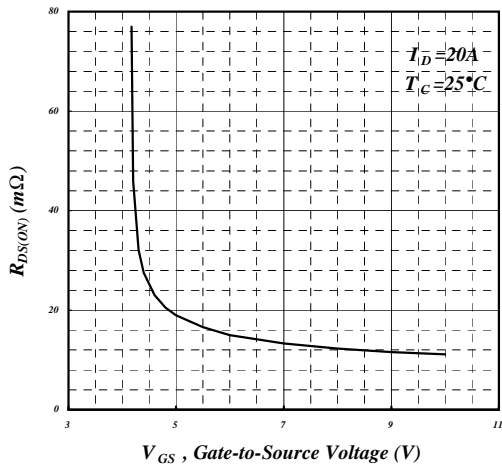

Fig 3. On-Resistance vs. Gate Voltage

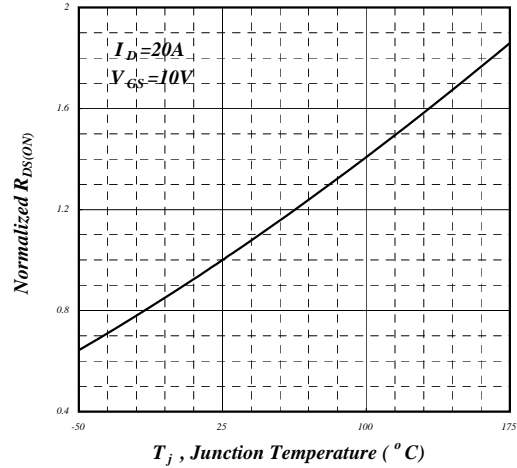

Fig 4. Normalized On-Resistance vs. Junction Temperature

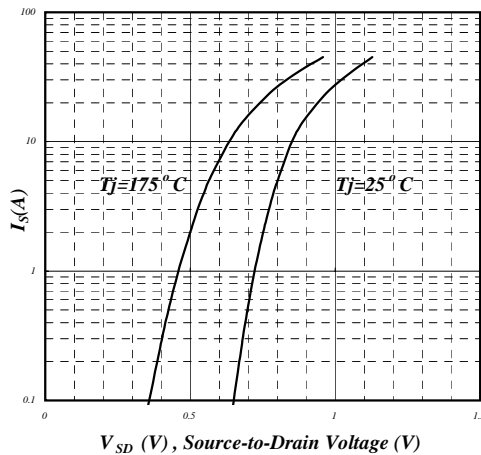

Fig 5. Forward Characteristic of Reverse Diode

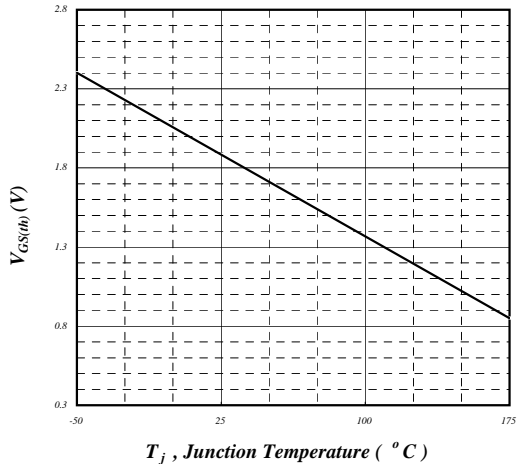

Fig 6. Gate Threshold Voltage vs. Junction Temperature

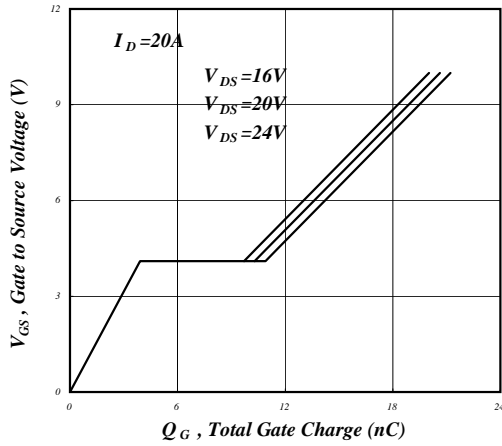

Fig 7. Gate Charge Characteristics

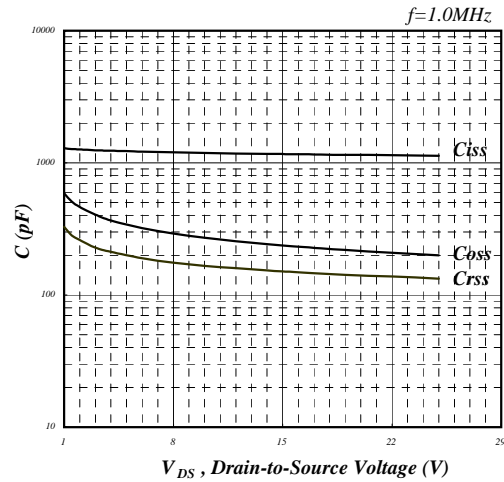

Fig 8. Typical Capacitance Characteristics

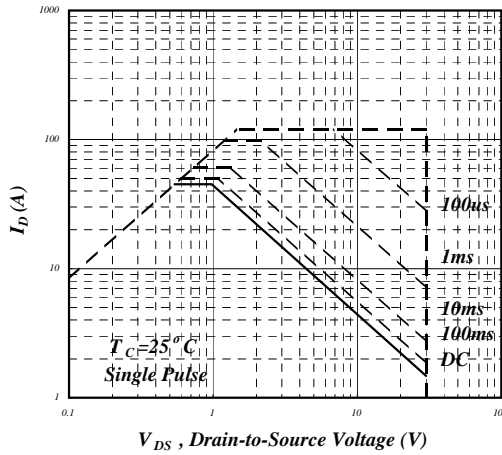

Fig 9. Maximum Safe Operating Area

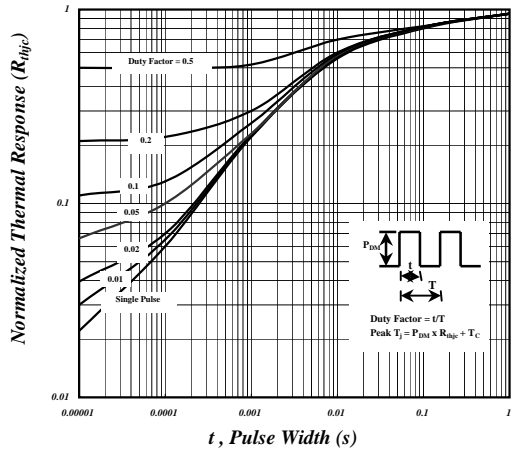

Fig 10. Effective Transient Thermal Impedance

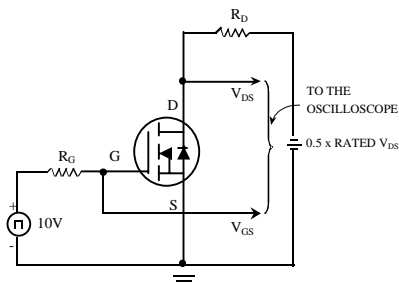

Fig 11. Switching Time Circuit

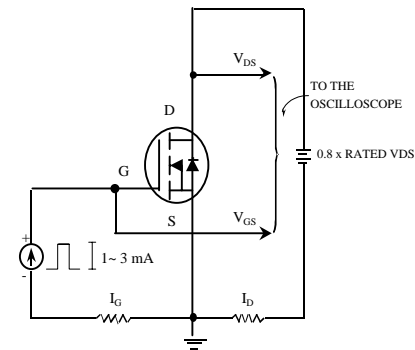

Fig 12. Gate Charge Circuit

Information furnished by Silicon Standard Corporation is believed to be accurate and reliable. However, Silicon Standard Corporation makes no guarantee or warranty, express or implied, as to the reliability, accuracy, timeliness or completeness of such information and assumes no responsibility for its use, or for infringement of any patent or other intellectual property rights of third parties that may result from its use. Silicon Standard reserves the right to make changes as it deems necessary to any products described herein for any reason, including without limitation enhancement in reliability, functionality or design. No license is granted, whether expressly or by implication, in relation to the use of any products described herein or to the use of any information provided herein, under any patent or other intellectual property rights of Silicon Standard Corporation or any third parties.