

GaAs IC 35 dB Voltage Variable Attenuator

Single Positive Control 0.5–2.5 GHz



AV103-12

Features

- Single Positive +5 V Control Voltage
- 35 dB Attenuation Range @ 0.9 GHz
- Less Than ± 1 dB Attenuation Change Over Temperature
- Excellent Linearity Performance

Description

The AV103-12 GaAs IC FET voltage variable attenuator provides 35 dB attenuation range at 900 MHz controlled by a single positive voltage. The VVA has a linear transfer curve of 9 dB/V slope, with input and output VSWR better than 2.1:1 over all states. Its attenuation range at 1900 MHz is 33 dB. It operates with supply voltage of +5 V and control voltage of 0 V to +5 V in a low cost SOIC-8 package. The RF ports require 100 pF DC blocking capacitors.

SOIC-8

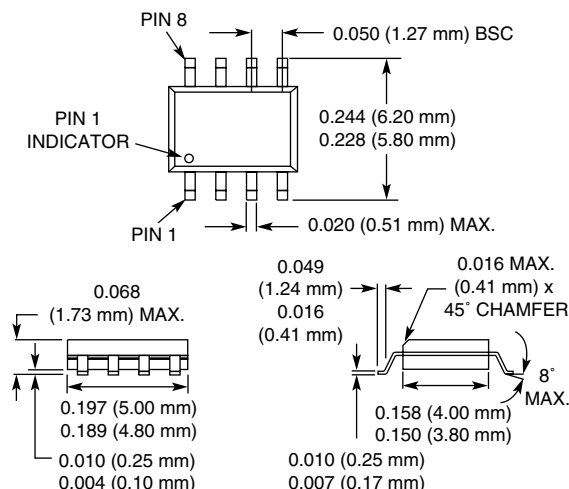

Electrical Specifications at 25°C ($V_S = 5$ V)

Parameter ¹	Frequency	Min.	Typ.	Max.	Unit
Insertion Loss ($V_C = 5$ V)	0.5–1.0 GHz		2.5	2.7	dB
	1.0–2.0 GHz		2.8	3.0	dB
	2.0–2.5 GHz		3.2	3.4	dB
Maximum Attenuation ($V_C = 0$ V) ²	0.5–0.8 GHz	28	32		dB
	0.8–1.0 GHz	31	35		dB
	1.0–1.7 GHz	30	34		dB
	1.7–2.0 GHz	29	33		dB
	2.0–2.5 GHz	28	32		dB
VSWR (I/O) ³	0.5–2.5 GHz		2.1:1		

Operating Characteristics at 25°C ($V_S = 5$ V)

Parameter ¹	Condition	Frequency	Min.	Typ.	Max.	Unit
Switching Characteristics	Rise, On (10/90% or 50% CTL to 90% RF)			130		nS
	Fall, Off (90/10% RF or 50% CTL to 10% RF)			60		nS
Intermodulation Intercept Point (IIP3) ³	For Two-tone Input Power 0 dBm	0.9 GHz		12		dBm
Control Voltage (V_C)			0.0		V_S	V
Supply Voltage (V_S)				5.0		V
Control Current (I_C)				$1.1 \times V_C$		mA
Supply Current (I_S)				150		μ A

1. All measurements made in a 50 Ω system, unless otherwise specified.

2. Maximum attenuation includes insertion loss.

3. For worst case state.

Typical Performance Data @ 0.9 GHz
(Unless Otherwise Specified)

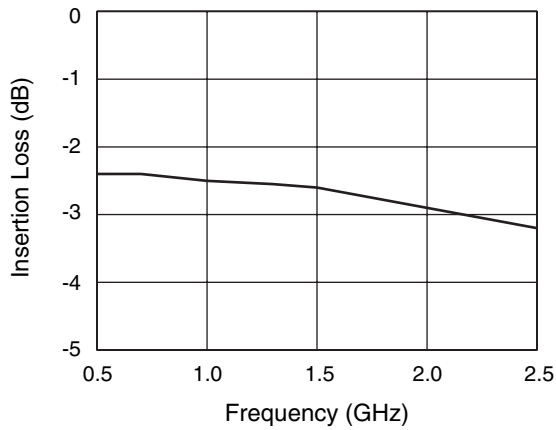

Insertion Loss vs. Frequency

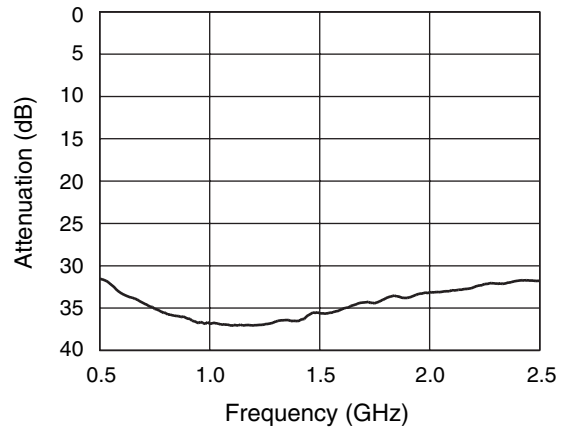

Maximum Attenuation vs. Frequency

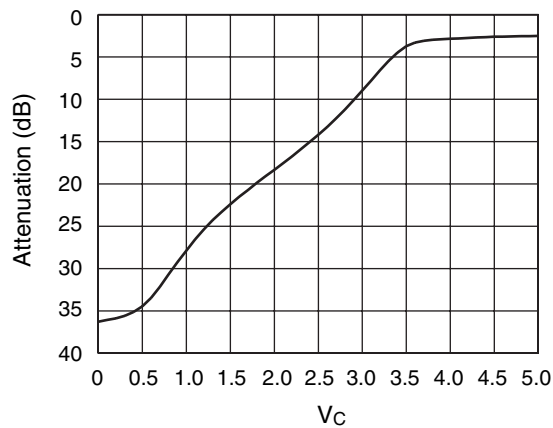

Attenuation vs. Control Voltage

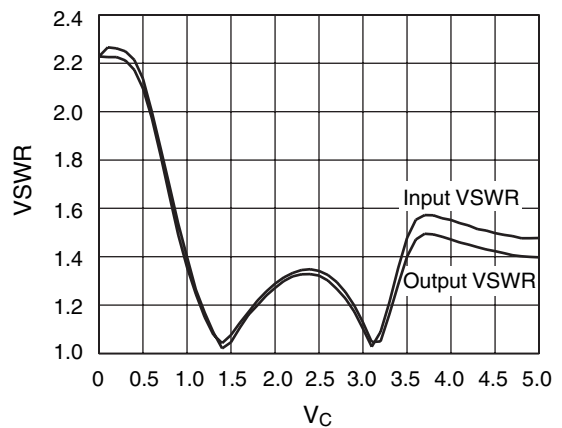

VSWR vs. Control Voltage

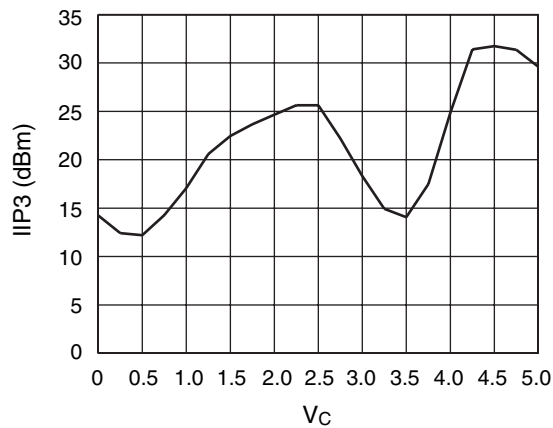

Input IP3 vs. Control Voltage

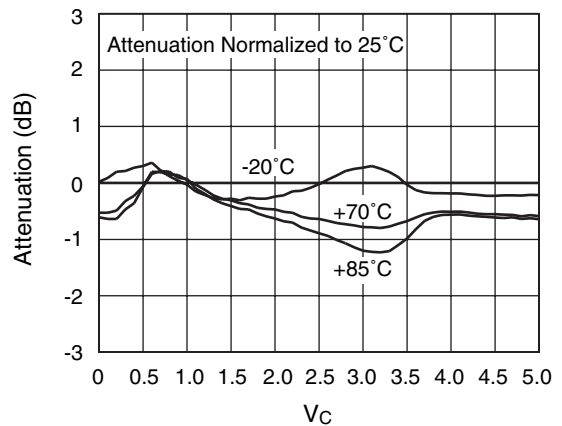

Attenuation vs. Control Voltage Over Temperature

Absolute Maximum Ratings

Characteristic	Value
RF Input Power	50 mW > 500 MHz
Supply Voltage	+4 to +8 V
Control Voltage	-0.2 V, +6.5 V (Do not allow control voltage to exceed V_S voltage.)
Operating Temperature	-55°C to +125°C
Storage Temperature	-65°C to +150°C
Θ_{JC}	25°C/W

Note: Exceeding these parameters may cause irreversible damage.

Pin Out

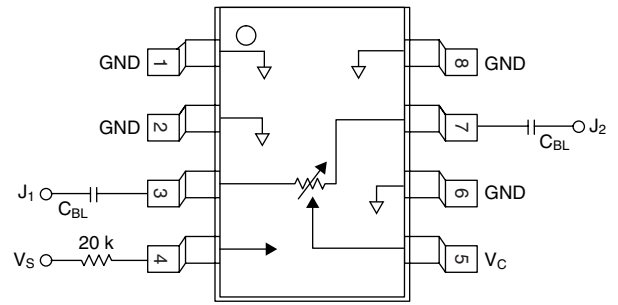

DC blocking capacitors (C_{BL}) supplied externally.
C_{BL} = 100 pF for operation >500 MHz.