

G3M

Solid State Relays



5A Load Switching provided for the whole G3M product line

- Thin design for high-density PCB applications.
- DC input-AC output for a 3-A load or a 5-A load.
- The 5A type is UL, CSA, EN (EN60950) approved.
- UL and CSA compliance for 3-A Relays (-UTU models have TÜV compliance as well).
- UL and CSA compliance for 5-A Relays (-VD models have VDE compliance as well).



RoHS Compliant

Refer to "Solid State Relays Common Precautions".

Model Number Legend

G3M-□□□□□-□-□
 1 2 3 4 5 6

1. Rated Load Power Supply Voltage

2: Maximum operating voltage lower than 264 V

2. Rated Load Current

03: 3 A

05: 5 A

3. Terminal Type

P: PCB terminals

4. Zero Cross Function

Blank: Equipped with zero cross function

L : Not equipped with zero cross function

5. Certification

Blank: UL and CSA for 3-A models

No certification for 5-A models

UTU : UL, CSA and TÜV for 3-A models

VD : UL, CSA and TÜV for 5-A models

UTU-1 : UL, CSA and TÜV for 3-A models with reinforced insulation

VD-1 : UL, CSA and TÜV for 5-A models with reinforced insulation

6. Input Terminal Pitch

Blank: 7.62 mm

4 : 5.08 mm

List of Models

Isolation	Input terminal pitch	Zero cross function	Indicator	Rated output load	Rated input voltage	Model	Minimum packing unit
Phototriac	7.62 mm	Yes	No	3 A at 100 to 240 VAC	5 VDC	G3M-203P 5 VDC	100 pcs
					12 VDC	G3M-203P 12 VDC	
					24 VDC	G3M-203P 24 VDC	
				5 A at 100 to 240 VAC	5 VDC	G3M-205P 5 VDC	
					12 VDC	G3M-205P 12 VDC	
					24 VDC	G3M-205P 24 VDC	
		No		3 A at 100 to 240 VAC	5 VDC	G3M-203PL 5 VDC	
					12 VDC	G3M-203PL 12 VDC	
					24 VDC	G3M-203PL 24 VDC	
				5 A at 100 to 240 VAC	5 VDC	G3M-205PL 5 VDC	
					12 VDC	G3M-205PL 12 VDC	
					24 VDC	G3M-205PL 24 VDC	
	5.08 mm	Yes	No	3 A at 100 to 240 VAC	5 VDC	G3M-203P-4 5 VDC	
					12 VDC	G3M-203P-4 12 VDC	
					24 VDC	G3M-203P-4 24 VDC	
				5 A at 100 to 240 VAC	5 VDC	G3M-205P-4 5 VDC	
					12 VDC	G3M-205P-4 12 VDC	
					24 VDC	G3M-205P-4 24 VDC	
		No		3 A at 100 to 240 VAC	5 VDC	G3M-203PL-4 5 VDC	
					12 VDC	G3M-203PL-4 12 VDC	
					24 VDC	G3M-203PL-4 24 VDC	
				5 A at 100 to 240 VAC	5 VDC	G3M-205PL-4 5 VDC	
					12 VDC	G3M-205PL-4 12 VDC	
					24 VDC	G3M-205PL-4 24 VDC	

■ Ratings

Input (Each model has 5-VDC, 12-VDC, and 24-VDC input versions.)

Rated voltage	Operating voltage	Impedance	Must operate voltage level	Must release voltage level
5 VDC	4 to 6 VDC	300 Ω ±20%	4 VDC max.	1 VDC min.
12 VDC	9.6 to 14.4 VDC	800 Ω ±20%	9.6 VDC max.	
24 VDC	19.2 to 28.8 VDC	1.6 kΩ ±20%	19.2 VDC max.	

Output

Item Model	Rated voltage	Applicable load		
		Load voltage range	Load current	Inrush current
G3M-203P(L)	100 to 240 VAC	75 to 264 VAC	0.1 to 3 A *	45 A (60 Hz, 1 cycle)
G3M-205P(L)			0.1 to 5 A *	60 A (60Hz, 1 cycle)

* The load current varies depending on the ambient temperature.
Refer to Load Current vs. Ambient Temperature under Engineering Data.

■ Characteristics

Item	Model	G3M-203P(L)	G3M-205P(L)
Operate time		G3M-□□□PL: 1 ms max. G3M-□□□P: 1/2 of load power source cycle + 1 ms max.	
Release time		1/2 of load power source cycle + 1 ms max.	
Output ON voltage drop		1.6 V (RMS) max.	
Leakage current		1.5 mA max. (at 200 VAC)	
Insulation resistance		1,000 MΩ min. (at 500 VDC)	
Dielectric strength		2,500 VAC, 50/60 Hz for 1 min between input and output	
Vibration resistance		10 to 55 to 10 Hz, 0.75-mm single amplitude (1.5-mm double amplitude)	
Shock resistance		1,000 m/s ²	
Ambient operating temperature		-30°C to 80°C (with no icing or condensation)	
Ambient operating humidity		45% to 85%RH	
Storage temperature		-30°C to 100°C (with no icing or condensation)	
Weight		Approx. 15 g	Approx. 25 g

Engineering Data

Load Current vs. Ambient Temperature

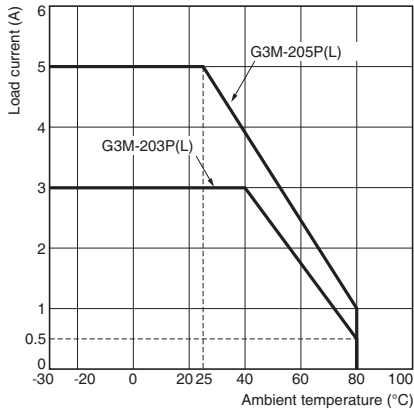

Load Current vs. Ambient Temperature (Close Mounting) G3M-205 Series (5-A Load)

<X direction>

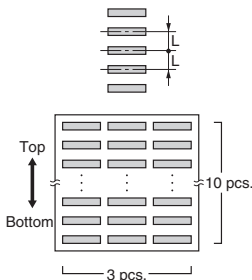
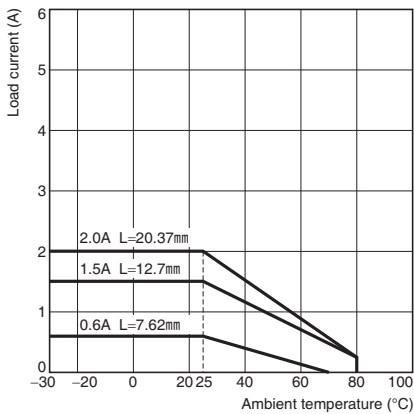

One Cycle Surge Current: Non-repetitive

Non-repetitive (Reduce the current under the dotted line of the impulse withstand current for repetitive operation)

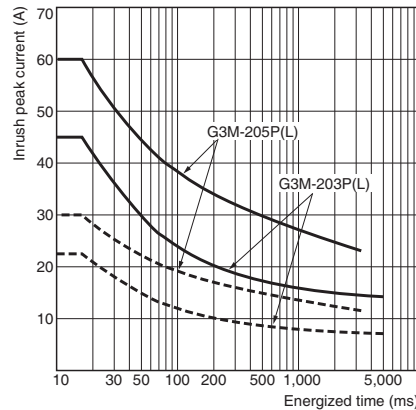

Operating Environment Precautions

The rated value for the ambient operating temperature of the SSR is determined under conditions when there is no heat build-up. (Left graph) Note that it is necessary to reduce the load current as the ambient temperature of the SSR may increase due to operating conditions. (Figure below is an example of the G3M-205P(L) model) When using the SSR, design the system to allow heat dissipation sufficient to stay below the Load Current vs. Ambient Temperature characteristic curve.

<Y direction>

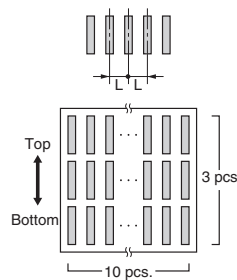
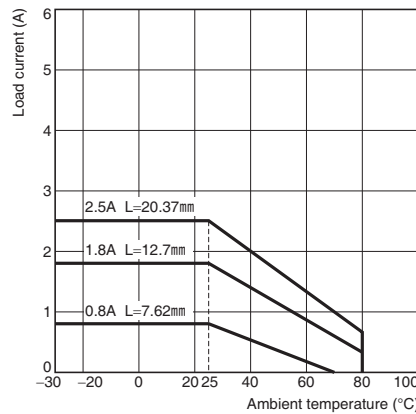

<Z direction>

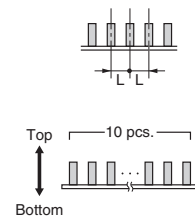
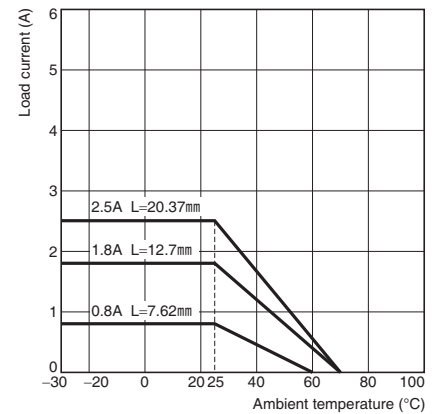

- Thirty Relays are soldered to the PCB at each given spacing.
- Continuous power.

■Dimensions

(Unit: mm)

G3M-203P(L) G3M-203P(L)-4

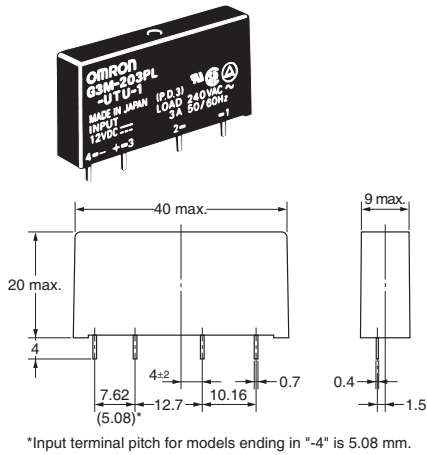

PCB Dimensions (BOTTOM VIEW) G3M-203P(L)

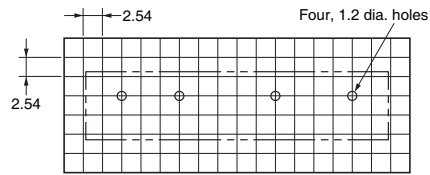

G3M-203P(L)-4

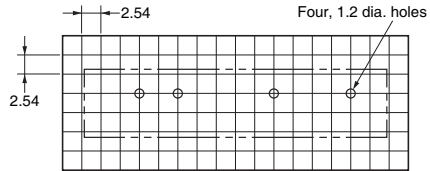

Terminal Arrangement (BOTTOM VIEW)

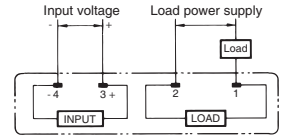

G3M-205P(L) G3M-205P(L)-4

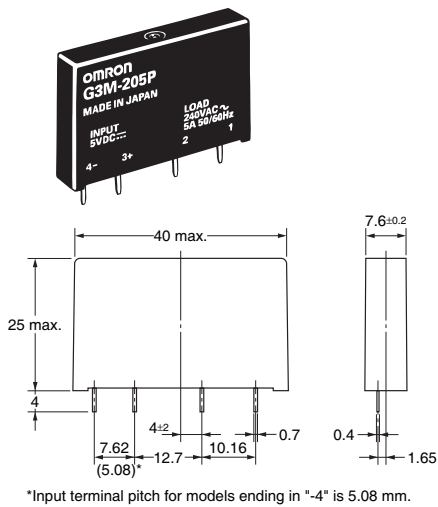

PCB Dimensions (BOTTOM VIEW) G3M-205P(L)

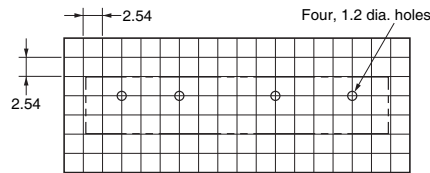

G3M-205P(L)-4

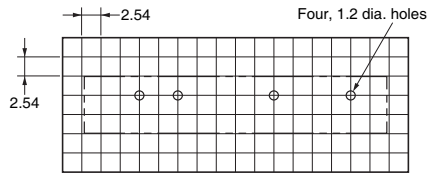

Terminal Arrangement (BOTTOM VIEW)

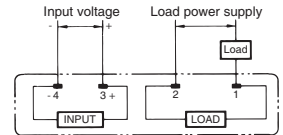

■Precautions

- Please refer to "Solid State Relays Common Precautions" for correct use.

- Application examples provided in this document are for reference only. In actual applications, confirm equipment functions and safety before using the product.
- Consult your OMRON representative before using the product under conditions which are not described in the manual or applying the product to nuclear control systems, railroad systems, aviation systems, vehicles, combustion systems, medical equipment, amusement machines, safety equipment, and other systems or equipment that may have a serious influence on lives and property if used improperly. Make sure that the ratings and performance characteristics of the product provide a margin of safety for the system or equipment, and be sure to provide the system or equipment with double safety mechanisms.

Note: Do not use this document to operate the Unit.

OMRON Corporation
Electronic and Mechanical Components Company

Contact: www.omron.com/ecb

Cat. No. K073-E1-07
1014(0207)(O)

Mouser Electronics

Authorized Distributor

Click to View Pricing, Inventory, Delivery & Lifecycle Information:

Omron:

[G3M-203P-4-DC24](#) [G3M-202P-US-DC12](#) [G3M-203P-DC12](#) [G3M-203P-DC24](#) [G3M-202P-US-4-DC12](#) [G3M-202P-US-DC24](#) [G3M-203P-DC5](#) [G3M-202P-US-4-DC5](#) [G3M-205PL-DC24](#) [G3M-203PL-DC24](#) [G3M-205PL-DC12](#) [G3M-205PL-DC5](#) [G3M-202P-US-DC5](#) [G3M-102PL-US DC12](#) [G3M-102PL-US DC24](#) [G3M-102PL-US-4 DC12](#) [G3M-102PL-US-4 DC24](#) [G3M-102PL-US-4 DC5](#) [G3M-202PL-US DC12](#) [G3M-202PL-US DC24](#) [G3M-202PL-US-4 DC12](#) [G3M-202PL-US-4 DC24](#) [G3M-202PL-US-4 DC5](#) [G3M-202P-US-4 DC24](#) [G3M-203P-4 DC12](#) [G3M-203P-4 DC5](#) [G3M-203PL DC12](#) [G3M-203PL DC5](#) [G3M-203PL-4 DC24](#) [G3M-203PL-4 DC5](#) [G3M-205P DC12](#) [G3M-205P DC24](#) [G3M-205P-4 DC12](#) [G3M-205P-4 DC24](#) [G3M-205P-4 DC5](#) [G3M-205PL-4 DC12](#) [G3M-205PL-4 DC24](#) [G3M-205PL-4 DC5](#) [G3M-202PL DC12](#) [G3M-202PL-UTU DC5](#) [G3M-202P-UTU DC5](#) [G3M-203P-UTU-1-4 DC12](#) [G3M-203P-UTU-1-4 DC5](#) [G3M-205P-DC5](#) [G3M-202PL-UTU-1-Z DC24](#) [G3M-203PL-UTU-1 DC24](#) [G3M-203P-UTU-1 DC5](#) [G3M-202PL-UTU-2-Z-DC24](#) [G3M-203P-UTU-1 DC12](#) [G3M-203P-UTU-1 DC24](#) [G3M-205P-VD-1 DC24V](#) [G3M-203PL-4 DC12](#)