

LOW INPUT VOLTAGE STEP-UP CONVERTER IN 6 PIN SC-70 PACKAGE

FEATURES

- Up to 95% Efficiency at Typical Operating Conditions
- 5.5 μ A Quiescent Current
- Startup Into Load at 0.7 V Input Voltage
- Operating Input Voltage from 0.7 V to 5.5 V
- Pass-Through Function during Shutdown
- Minimum Switching Current 200 mA
- Protections:
 - Output Overvoltage
 - Overtemperature
 - Input Undervoltage Lockout

- Adjustable Output Voltage from 1.8 V to 5.5 V
- Fixed Output Voltage Versions
- Small 6-pin SC-70 Package

APPLICATIONS

- Battery Powered Applications
 - 1 to 3 Cell Alkaline, NiCd or NiMH
 - 1 cell Li-Ion or Li-Primary
- Solar or Fuel Cell Powered Applications
- Consumer and Portable Medical Products
- Personal Care Products
- White or Status LEDs
- Smartphones

DESCRIPTION

The TPS6122x family devices provide a power-supply solution for products powered by either a single-cell, two-cell, or three-cell alkaline, NiCd or NiMH, or one-cell Li-Ion or Li-polymer battery. Possible output currents depend on the input-to-output voltage ratio. The boost converter is based on a hysteretic controller topology using synchronous rectification to obtain maximum efficiency at minimal quiescent currents. The output voltage of the adjustable version can be programmed by an external resistor divider, or is set internally to a fixed output voltage. The converter can be switched off by a featured enable pin. While being switched off, battery drain is minimized. The device is offered in a 6-pin SC-70 package (DCK) measuring 2 mm x 2 mm to enable small circuit layout size.

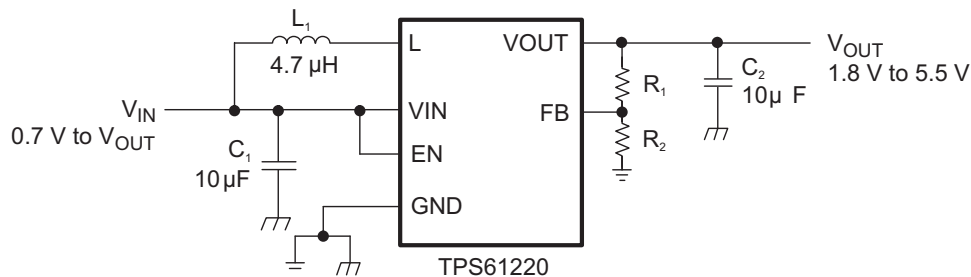

Efficiency vs Output Current and Input Voltage ($V_{OUT} = 3.3V$)

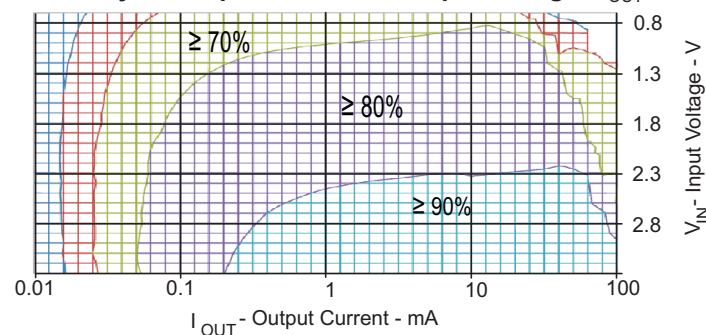

Please be aware that an important notice concerning availability, standard warranty, and use in critical applications of Texas Instruments semiconductor products and disclaimers thereto appears at the end of this data sheet.



These devices have limited built-in ESD protection. The leads should be shorted together or the device placed in conductive foam during storage or handling to prevent electrostatic damage to the MOS gates.

AVAILABLE DEVICE OPTIONS⁽¹⁾

T _A	OUTPUT VOLTAGE DC/DC	PACKAGE MARKING	PACKAGE ⁽²⁾	PART NUMBER ⁽³⁾
–40°C to 85°C	Adjustable	CKR	6-Pin SC-70	TPS61220DCK
	3.3 V	CKS		TPS61221DCK
	5.0 V	CKT		TPS61222DCK

- (1) Contact the factory to check availability of other fixed output voltage versions.
- (2) For the most current package and ordering information, see the Package Option Addendum at the end of this document, or see the TI website at www.ti.com.
- (3) The DCK package is available taped and reeled. Add R suffix to device type (e.g., TPS61220DCKR) to order quantities of 3000 devices per reel. It is also available in minireels. Add a T suffix to the device type (i.e. TPS61220DCKT) to order quantities of 250 devices per reel.

ABSOLUTE MAXIMUM RATINGS

over operating free-air temperature range (unless otherwise noted)⁽¹⁾

		TPS6122x	UNIT
V _{IN}	Input voltage range on VIN, L, VOUT, EN, FB	– 0.3 to 7.5	V
T _J	Operating junction temperature range	–40 to 150	°C
T _{stg}	Storage temperature range	–65 to 150	°C
ESD	Human Body Model (HBM) ⁽²⁾	2	kV
	Machine Model (MM) ⁽²⁾	200	V
	Charged Device Model (CDM) ⁽²⁾	1.5	kV

- (1) Stresses beyond those listed under *Absolute Maximum Ratings* may cause permanent damage to the device. These are stress ratings only, and functional operation of the device at these or any other conditions beyond those indicated under *Recommended Operating Conditions* is not implied. Exposure to absolute-maximum-rated conditions for extended periods may affect device reliability.
- (2) ESD testing is performed according to the respective JEDEC standard.

DISSIPATION RATINGS TABLE

PACKAGE	THERMAL RESISTANCE θ _{JA} ⁽¹⁾	THERMAL RESISTANCE θ _{JB}	THERMAL RESISTANCE θ _{JC}	POWER RATING T _A ≤ 25°C	DERATING FACTOR ABOVE T _A = 25°C
DCK	225 °C/W	70 °C/W	110 °C/W	444 mW	4.44 mW/°C

- (1) Thermal ratings are determined assuming a high K PCB design according to JEDEC standard JESD51-7.

RECOMMENDED OPERATING CONDITIONS

		MIN	NOM	MAX	UNIT
V _{IN}	Supply voltage at VIN	0.7		5.5	V
T _A	Operating free air temperature range	–40		85	°C
T _J	Operating virtual junction temperature range	–40		125	°C

ELECTRICAL CHARACTERISTICS

over recommended free-air temperature range and over recommended input voltage range (typical at an ambient temperature range of 25°C) (unless otherwise noted)

DC/DC STAGE						
PARAMETER		TEST CONDITIONS	MIN	TYP	MAX	UNIT
V_{IN}	Input voltage range		0.7		5.5	V
V_{IN}	Minimum input voltage at startup	$R_{Load} \geq 150 \Omega$			0.7	V
V_{OUT}	TPS61220 output voltage range	$V_{IN} < V_{OUT}$	1.8		5.5	V
V_{FB}	TPS61220 feedback voltage		483	500	513	mV
V_{OUT}	TPS61221 output voltage (3.3V)	$V_{IN} < V_{OUT}$	3.20	3.30	3.41	V
V_{OUT}	TPS61222 output voltage (5V)	$V_{IN} < V_{OUT}$	4.82	5.00	5.13	V
I_{LH}	Inductor current ripple			200		mA
I_{SW}	switch current limit	$V_{OUT} = 3.3 \text{ V}, V_{IN} = 1.2 \text{ V}, T_A = 25^\circ \text{C}$	240	400		mA
		$V_{OUT} = 3.3 \text{ V}$	200	400		mA
R_{DSon_HSD}	Rectifying switch on resistance	$V_{OUT} = 3.3 \text{ V}$		1000		m Ω
		$V_{OUT} = 5.0 \text{ V}$		700		m Ω
R_{DSon_LSD}	Main switch on resistance	$V_{OUT} = 3.3 \text{ V}$		600		m Ω
		$V_{OUT} = 5.0 \text{ V}$		550		m Ω
	Line regulation	$V_{IN} < V_{OUT}$		0.5 %		
	Load regulation	$V_{IN} < V_{OUT}$		0.5 %		
I_Q	Quiescent current	V_{IN}	$I_O = 0 \text{ mA}, V_{EN} = V_{IN} = 1.2 \text{ V}, V_{OUT} = 3.3 \text{ V}$	0.5	0.9	μA
		V_{OUT}		5	7.5	μA
I_{SD}	Shutdown current	V_{IN}	$V_{EN} = 0 \text{ V}, V_{IN} = 1.2 \text{ V}, V_{OUT} \geq V_{IN}$	0.2	0.5	μA
I_{LKG_VOUT}	Leakage current into VOUT	$V_{EN} = 0 \text{ V}, V_{IN} = 1.2 \text{ V}, V_{OUT} = 3.3 \text{ V}$		1		μA
I_{LKG_L}	Leakage current into L	$V_{EN} = 0 \text{ V}, V_{IN} = 1.2 \text{ V}, V_L = 1.2 \text{ V}, V_{OUT} \geq V_{IN}$		0.01	0.2	μA
I_{FB}	TPS61220 Feedback input current	$V_{FB} = 0.5 \text{ V}$			0.01	μA
I_{EN}	EN input current	Clamped on GND or V_{IN} ($V_{IN} < 1.5 \text{ V}$)		0.005	0.1	μA
CONTROL STAGE						
PARAMETER		TEST CONDITIONS	MIN	TYP	MAX	UNIT
V_{IL}	EN input low voltage	$V_{IN} \leq 1.5 \text{ V}$			$0.2 \times V_{IN}$	V
V_{IH}	EN input high voltage	$V_{IN} \leq 1.5 \text{ V}$	$0.8 \times V_{IN}$			V
V_{IL}	EN input low voltage	$5 \text{ V} > V_{IN} > 1.5 \text{ V}$			0.4	V
V_{IH}	EN input high voltage	$5 \text{ V} > V_{IN} > 1.5 \text{ V}$	1.2			V
V_{UVLO}	Undervoltage lockout threshold for turn off	V_{IN} decreasing		0.5	0.7	V
	Overvoltage protection threshold		5.5		7.5	V
	Overtemperature protection			140		$^\circ\text{C}$
	Overtemperature hysteresis			20		$^\circ\text{C}$

PIN ASSIGNMENTS

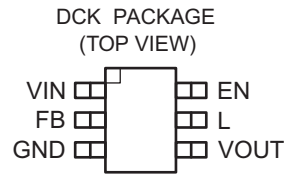

Terminal Functions

TERMINAL NAME	TERMINAL NO.	I/O	DESCRIPTION
EN	6	I	Enable input (1: enabled, 0: disabled). Must be actively tied high or low.
FB	2	I	Voltage feedback of adjustable version. Must be connected to V_{OUT} at fixed output voltage versions.
GND	3		Control / logic and power ground
L	5	I	Connection for Inductor
VIN	1	I	Boost converter input voltage
VOUT	4	O	Boost converter output voltage

FUNCTIONAL BLOCK DIAGRAM (ADJUSTABLE VERSION)

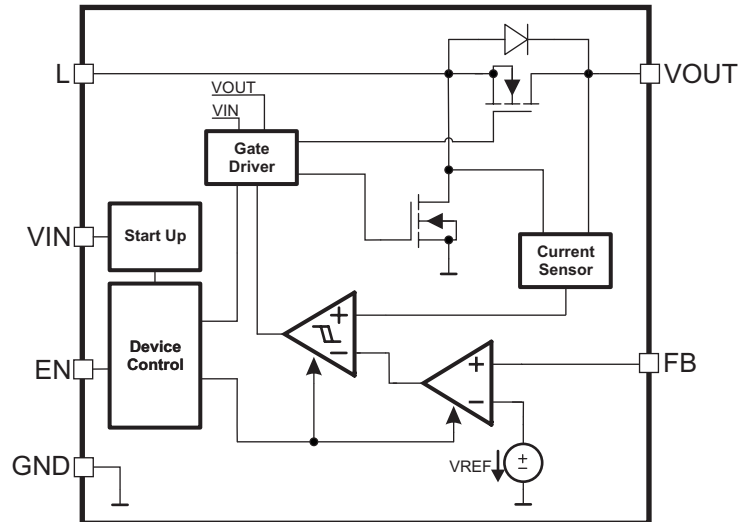

FUNCTIONAL BLOCK DIAGRAM (FIXED OUTPUT VOLTAGE VERSION)

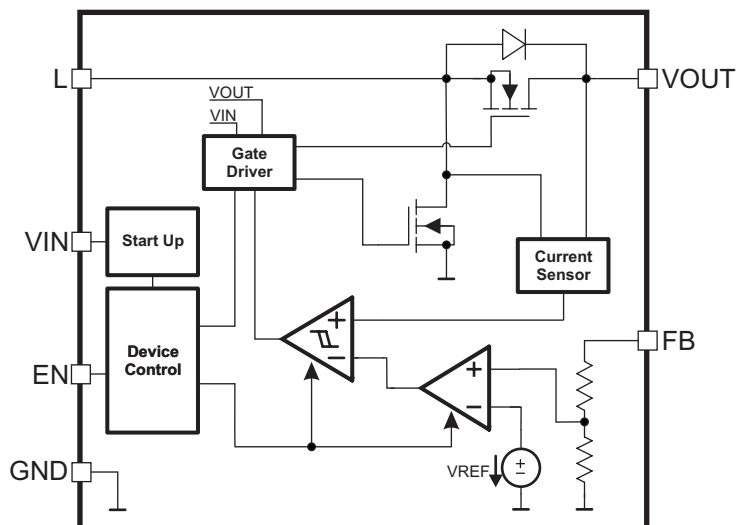

PARAMETER MEASUREMENT INFORMATION

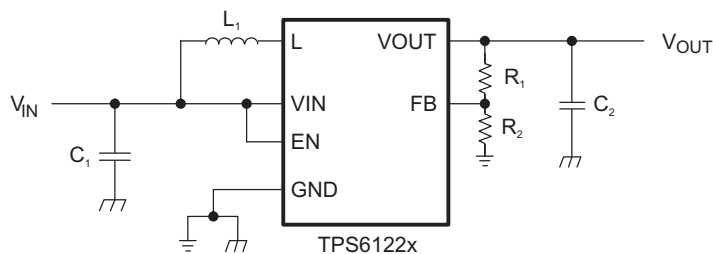

List of Components:

COMPONENT REFERENCE	PART NUMBER	MANUFACTURER	VALUE
C ₁	GRM188R60J106ME84D	Murata	10 μF, 6.3V. X5R Ceramic
C ₂	GRM188R60J106ME84D	Murata	10 μF, 6.3V. X5R Ceramic
L ₁	EPL3015-472MLB	Coilcraft	4.7 μH
R ₁ , R ₂			adjustable version: Values depending on the programmed output voltage fixed version: R ₁ = 0 Ω, R ₂ not used

TYPICAL CHARACTERISTICS

Table of Graphs

		FIGURE
Maximum Output Current	vs Input Voltage (TPS61220, TPS61221, TPS61222)	1
Efficiency	vs Output Current, $V_{OUT} = 1.8\text{ V}$, $V_{IN} = [0.7\text{ V}; 1.2\text{ V}; 1.5\text{ V}]$ (TPS61220)	2
	vs Output Current, $V_{IN} = [0.7\text{ V}; 1.2\text{ V}; 2.4\text{ V}; 3\text{ V}]$ (TPS61221)	3
	vs Output Current, $V_{IN} = [0.7\text{ V}; 1.2\text{ V}; 2.4\text{ V}; 3.6\text{ V}; 4.2\text{ V}]$ (TPS61222)	4
	vs Input Voltage, $V_{OUT} = 1.8\text{ V}$, $I_{OUT} = [100\text{ }\mu\text{A}; 1\text{ mA}; 10\text{ mA}; 50\text{ mA}]$ (TPS61220)	5
	vs Input Voltage, $I_{OUT} = [100\text{ }\mu\text{A}; 1\text{ mA}; 10\text{ mA}; 50\text{ mA}]$ (TPS61221)	6
	vs Input Voltage, $I_{OUT} = [100\text{ }\mu\text{A}; 1\text{ mA}; 10\text{ mA}; 50\text{ mA}]$ (TPS61222)	7
	Input Current	at No Output Load, Device Enabled (TPS61220, TPS61221, TPS61222)
Output Voltage	vs Output Current, $V_{OUT} = 1.8\text{ V}$, $V_{IN} = [0.7\text{ V}; 1.2\text{ V}]$ (TPS61220)	9
	vs Output Current, $V_{IN} = [0.7\text{ V}; 1.2\text{ V}; 2.4\text{ V}]$ (TPS61221)	10
	vs Output Current, $V_{IN} = [0.7\text{ V}; 1.2\text{ V}; 2.4\text{ V}; 3.6\text{ V}]$ (TPS61222)	11
	vs Input Voltage, Device Disabled, $R_{LOAD} = [1\text{ k}\Omega; 10\text{ k}\Omega]$ (TPS6122x)	12
Waveforms	Output Voltage Ripple, $V_{IN} = 0.8\text{ V}$, $V_{OUT} = 1.8\text{ V}$, $I_{OUT} = 20\text{ mA}$ (TPS61220)	13
	Output Voltage Ripple $V_{IN} = 1.8\text{ V}$, $I_{OUT} = 50\text{ mA}$ (TPS61221)	14
	Load Transient Response, $V_{IN} = 1.2\text{ V}$, $I_{OUT} = 6\text{ mA}$ to 50 mA (TPS61221)	15
	Load Transient Response, $V_{IN} = 2.4\text{ V}$, $I_{OUT} = 14\text{ mA}$ to 126 mA (TPS61222)	16
	Line Transient Response, $V_{IN} = 1.8\text{ V}$ to 2.4 V , $R_{LOAD} = 100\text{ }\Omega$ (TPS61221)	17
	Line Transient Response, $V_{IN} = 2.8\text{ V}$ to 3.6 V , $R_{LOAD} = 100\text{ }\Omega$ (TPS61222)	18
	Startup after Enable, $V_{IN} = 0.7\text{ V}$, $V_{OUT} = 1.8\text{ V}$, $R_{LOAD} = 150\text{ }\Omega$ (TPS61220)	19
	Startup after Enable, $V_{IN} = 0.7\text{ V}$, $R_{LOAD} = 150\text{ }\Omega$, (TPS61222)	20
	Continuous Current Operation, $V_{IN} = 1.2\text{ V}$, $V_{OUT} = 1.8\text{ V}$, $I_{OUT} = 50\text{ mA}$ (TPS61220)	21
	Discontinuous Current Operation, $V_{IN} = 1.2\text{ V}$, $V_{OUT} = 1.8\text{ V}$, $I_{OUT} = 10\text{ mA}$ (TPS61220)	22

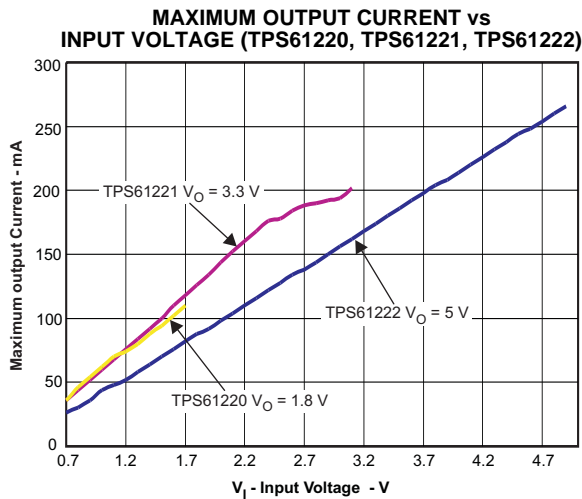

Figure 1.

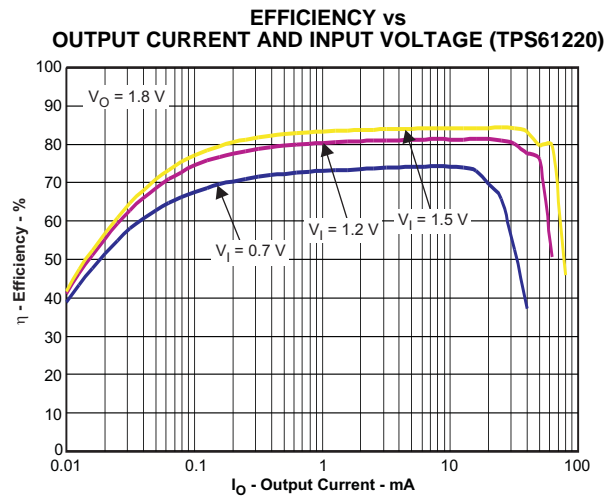

Figure 2.

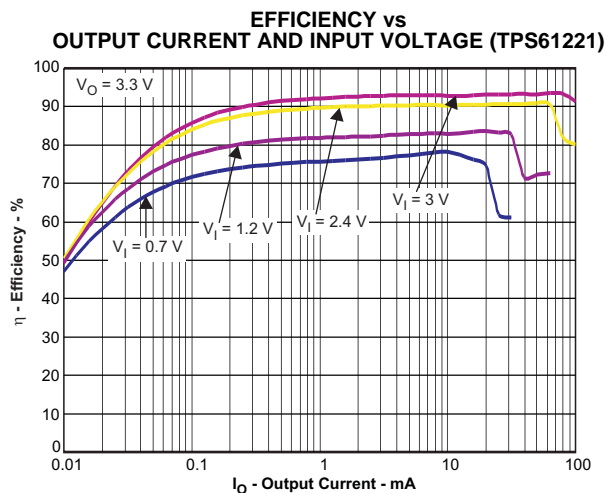

Figure 3.

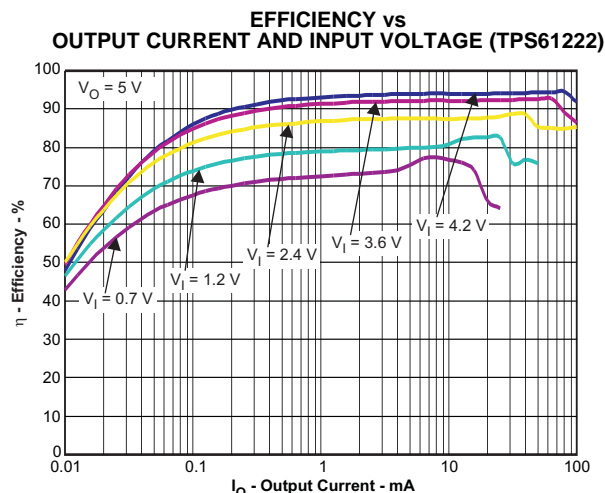

Figure 4.

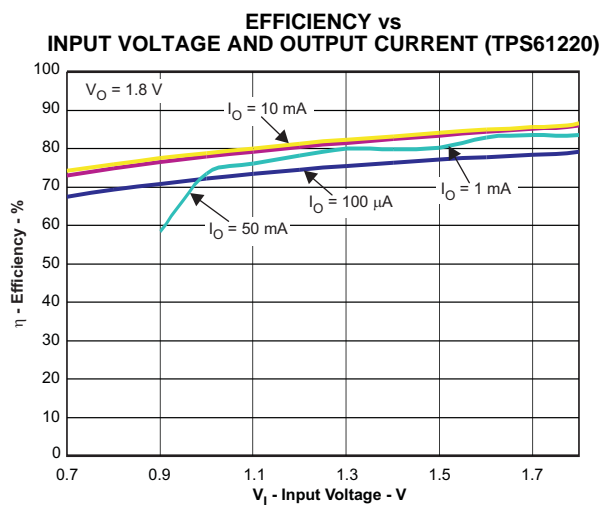

Figure 5.

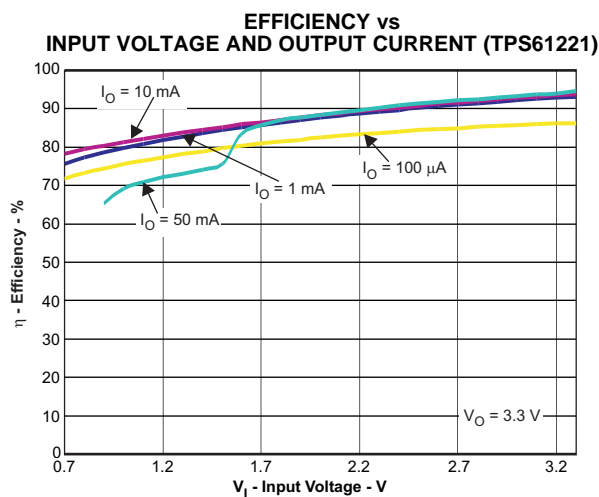

Figure 6.

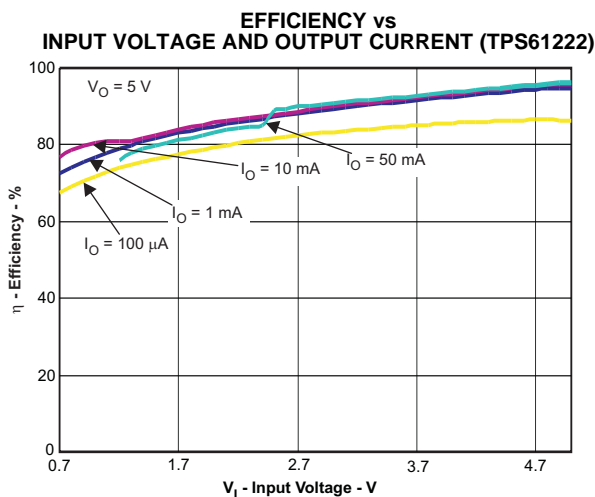

Figure 7.

**NO LOAD INPUT CURRENT vs
INPUT VOLTAGE, DEVICE ENABLED (TPS61220 V_{OUT}=1.8,
TPS61221, TPS61222)**

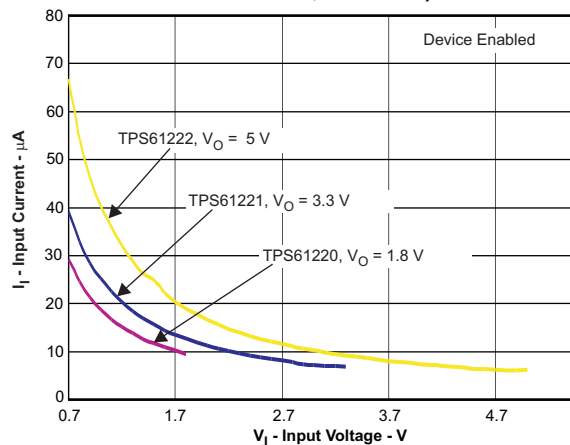

Figure 8.

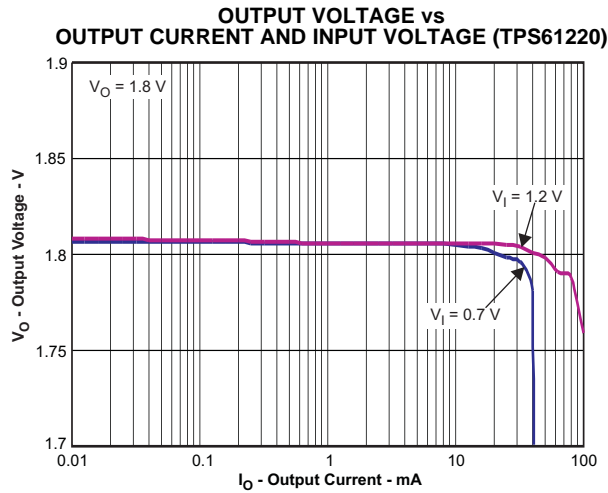

Figure 9.

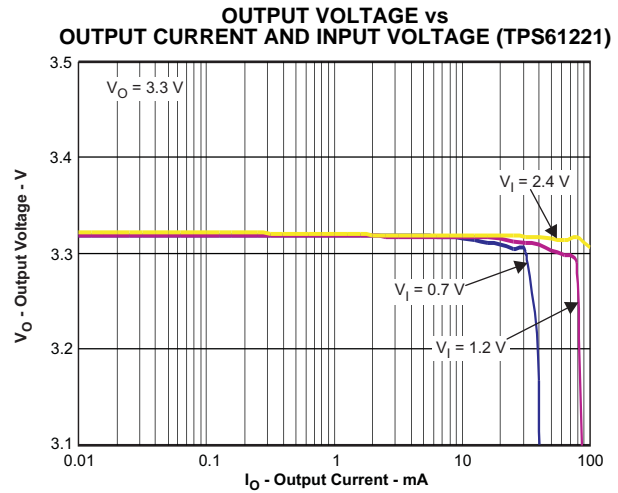

Figure 10.

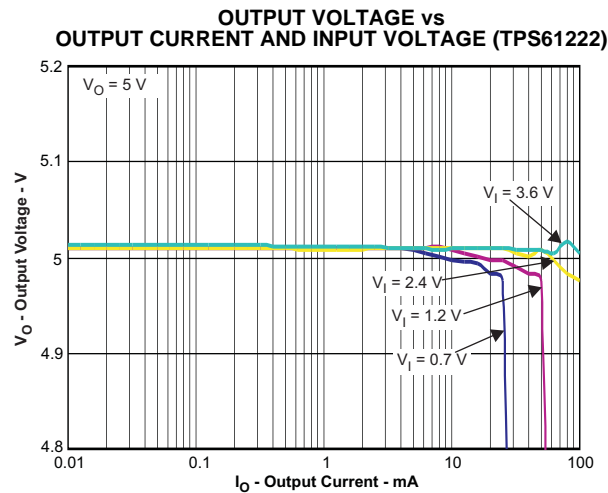

Figure 11.

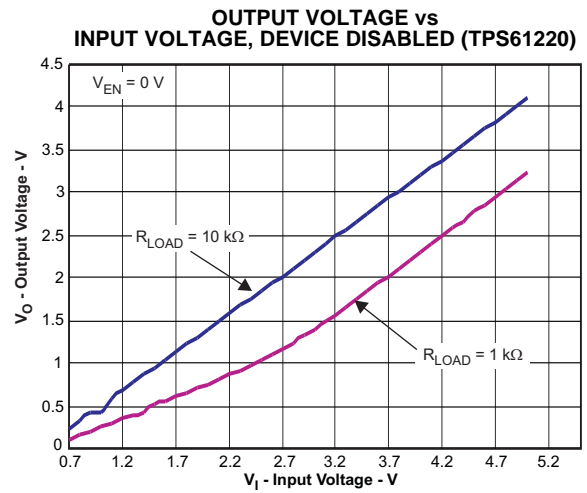

Figure 12.

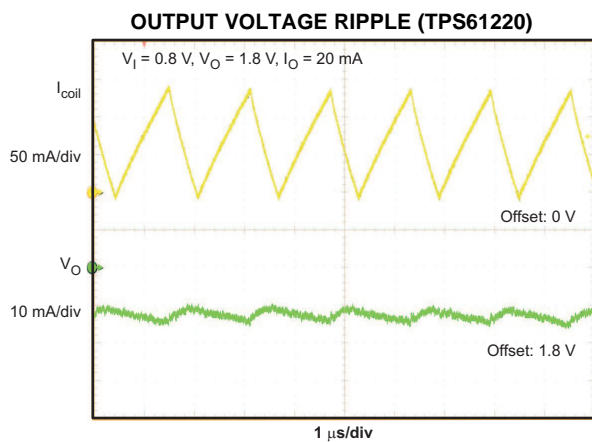

Figure 13.

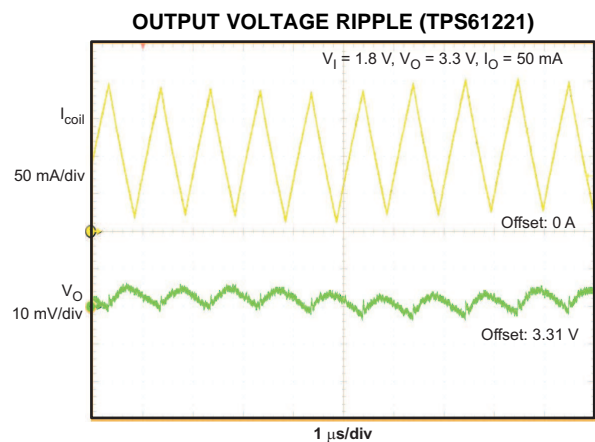

Figure 14.

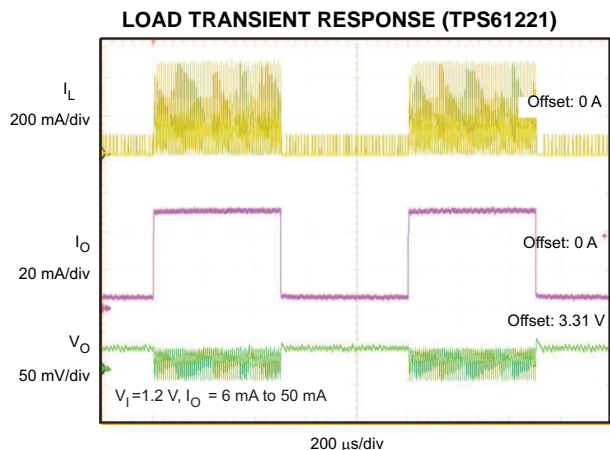

Figure 15.

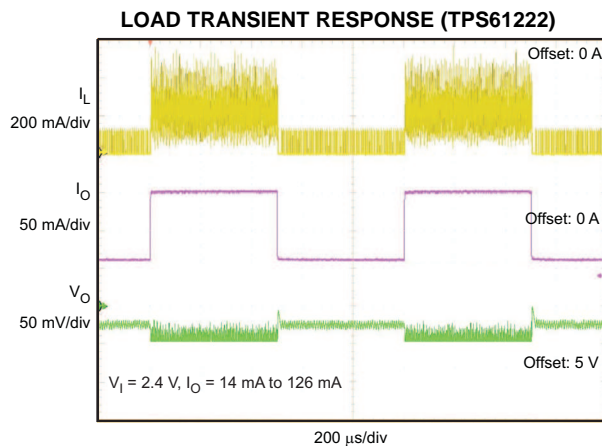

Figure 16.

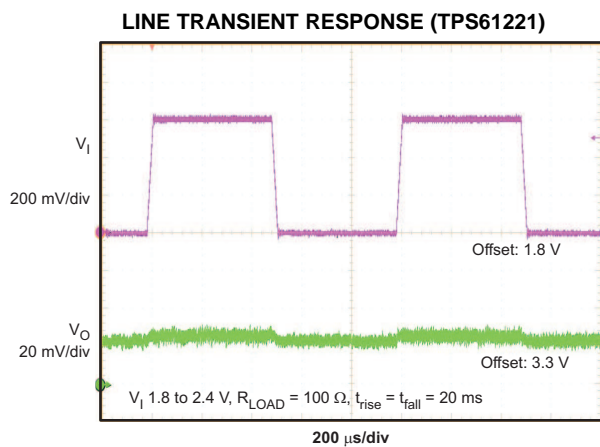

Figure 17.

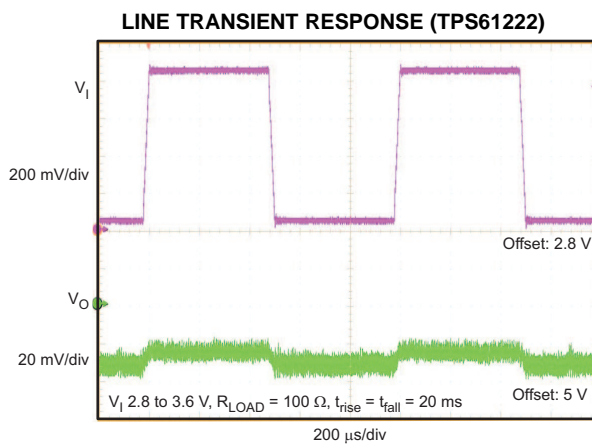

Figure 18.

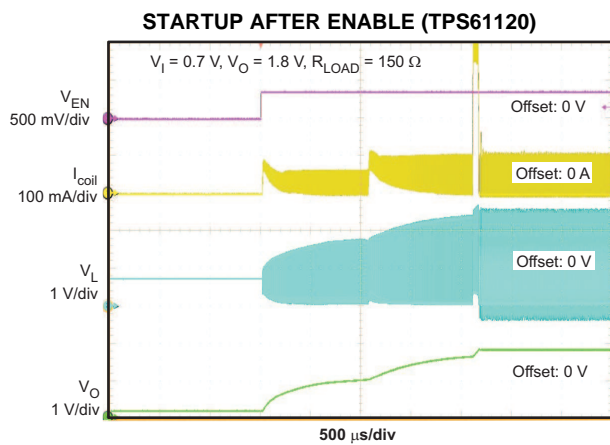

Figure 19.

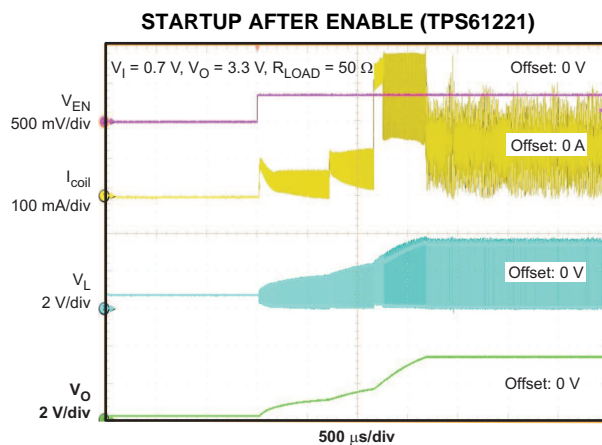

Figure 20.

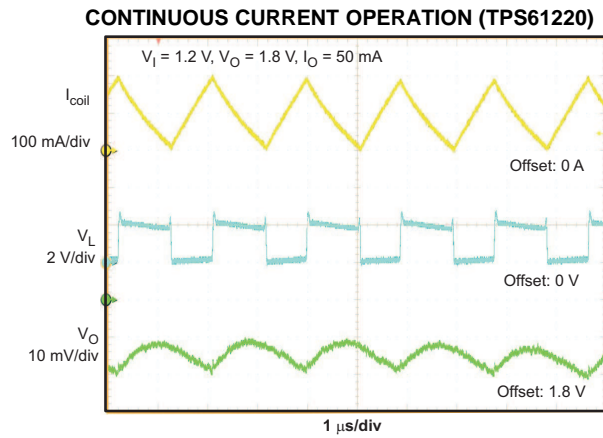

Figure 21.

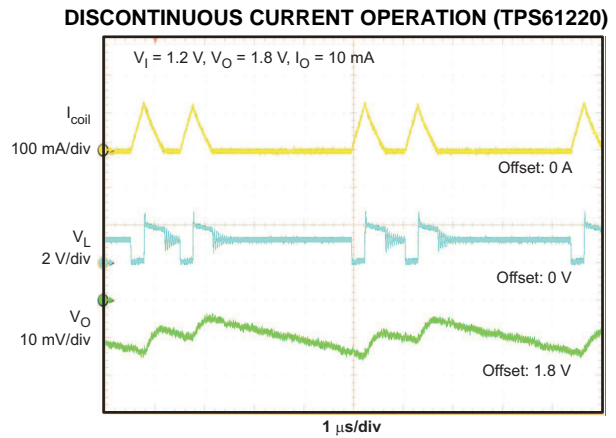

Figure 22.

DETAILED DESCRIPTION

OPERATION

The TPS6122x is a high performance, high efficient family of switching boost converters. To achieve high efficiency the power stage is realized as a synchronous boost topology. For the power switching two actively controlled low R_{DSon} power MOSFETs are implemented.

CONTROLLER CIRCUIT

The device is controlled by a hysteretic current mode controller. This controller regulates the output voltage by keeping the inductor ripple current constant in the range of 200 mA and adjusting the offset of this inductor current depending on the output load. In case the required average input current is lower than the average inductor current defined by this constant ripple the inductor current gets discontinuous to keep the efficiency high at low load conditions.

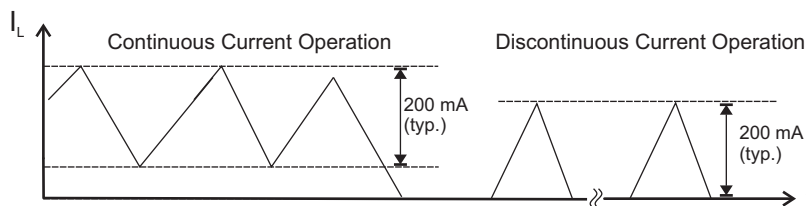

Figure 23. Hysteretic Current Operation

The output voltage V_{OUT} is monitored via the feedback network which is connected to the voltage error amplifier. To regulate the output voltage, the voltage error amplifier compares this feedback voltage to the internal voltage reference and adjusts the required offset of the inductor current accordingly. At fixed output voltage versions an internal feedback network is used to program the output voltage, at adjustable versions an external resistor divider needs to be connected.

The self oscillating hysteretic current mode architecture is inherently stable and allows fast response to load variations. It also allows using inductors and capacitors over a wide value range.

Device Enable and Shutdown Mode

The device is enabled when EN is set high and shut down when EN is low. During shutdown, the converter stops switching and all internal control circuitry is turned off. In this case the input voltage is connected to the output through the back-gate diode of the rectifying MOSFET. This means that there always will be voltage at the output which can be as high as the input voltage or lower depending on the load.

Startup

After the EN pin is tied high, the device starts to operate. In case the input voltage is not high enough to supply the control circuit properly a startup oscillator starts to operate the switches. During this phase the switching frequency is controlled by the oscillator and the maximum switch current is limited. As soon as the device has built up the output voltage to about 1.8V, high enough for supplying the control circuit, the device switches to its normal hysteretic current mode operation. The startup time depends on input voltage and load current.

Operation at Output Overload

If in normal boost operation the inductor current reaches the internal switch current limit threshold the main switch is turned off to stop further increase of the input current.

In this case the output voltage will decrease since the device can not provide sufficient power to maintain the set output voltage.

If the output voltage drops below the input voltage the backgate diode of the rectifying switch gets forward biased and current starts flow through it. This diode cannot be turned off, so the current finally is only limited by the remaining DC resistances. As soon as the overload condition is removed, the converter resumes providing the set output voltage.

Undervoltage Lockout

An implemented undervoltage lockout function stops the operation of the converter if the input voltage drops below the typical undervoltage lockout threshold. This function is implemented in order to prevent malfunctioning of the converter.

Overvoltage Protection

If, for any reason, the output voltage is not fed back properly to the input of the voltage amplifier, control of the output voltage will not work anymore. Therefore an overvoltage protection is implemented to avoid the output voltage exceeding critical values for the device and possibly for the system it is supplying. For this protection the TPS6122x output voltage is also monitored internally. In case it reaches the internally programmed threshold of 6.5 V typically the voltage amplifier regulates the output voltage to this value.

If the TPS6122x is used to drive LEDs, this feature protects the circuit if the LED fails.

Overtemperature Protection

The device has a built-in temperature sensor which monitors the internal IC junction temperature. If the temperature exceeds the programmed threshold (see electrical characteristics table), the device stops operating. As soon as the IC temperature has decreased below the programmed threshold, it starts operating again. To prevent unstable operation close to the region of overtemperature threshold, a built-in hysteresis is implemented.

APPLICATION INFORMATION

DESIGN PROCEDURE

The TPS6122x DC/DC converters are intended for systems powered by a single cell battery to up to three Alkaline, NiCd or NiMH cells with a typical terminal voltage between 0.7 V and 5.5 V. They can also be used in systems powered by one-cell Li-Ion or Li-Polymer batteries with a typical voltage between 2.5 V and 4.2 V. Additionally, any other voltage source with a typical output voltage between 0.7 V and 5.5 V can be used with the TPS6122x family.

Programming the Output Voltage

Fixed output voltage versions

At fixed voltage versions, the output voltage is set by a resistor divider internally. The FB pin is used to sense the output voltage. To configure the fixed output devices properly, the FB pin needs to be connected directly to VOUT as shown in Figure 24.

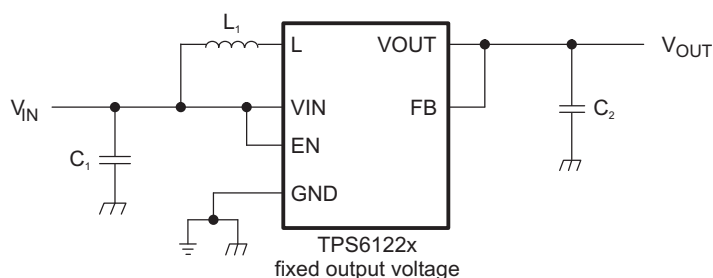

Figure 24. Typical Application Circuit for Fixed Output Voltage Option

Adjustable output voltage version

In the adjustable output versions, an external resistor divider is used to adjust the output voltage. The resistor divider needs to be connected between VOUT, FB and GND as shown in Figure 25. When the output voltage is regulated properly, the typical voltage value at the FB pin is 500 mV for the adjustable devices. The maximum recommended value for the output voltage is 5.5 V. The current through the resistive divider should be about 100 times greater than the current into the FB pin. The typical current into the FB pin is 0.01 μ A, and the voltage across the resistor between FB and GND, R_2 , is typically 500 mV. Based on those two values, the recommended value for R_2 should be lower than 500 k Ω , in order to set the divider current to 1 μ A or higher. The value of the resistor connected between VOUT and FB, R_1 , depending on the needed output voltage (V_{OUT}), can be calculated using Equation 1:

$$R_1 = R_2 \times \left(\frac{V_{OUT}}{V_{FB}} - 1 \right) \quad (1)$$

As an example, if an output voltage of 3.3 V is needed, a 1-M Ω resistor is calculated for R_1 when for R_2 a 180-k Ω has been selected.

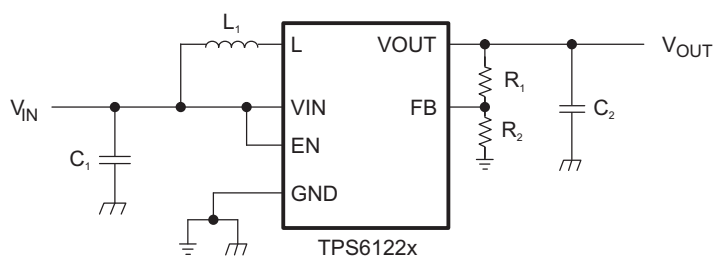

Figure 25. Typical Application Circuit for Adjustable Output Voltage Option

Inductor Selection

To make sure that the TPS6122x devices can operate, a suitable inductor must be connected between pin VIN and pin L. Inductor values of 4.7 μH show good performance over the whole input and output voltage range .

Choosing other inductance values affects the switching frequency f proportional to $1/L$ as shown in [Equation 2](#).

$$L = \frac{1}{f \times 200 \text{ mA}} \times \frac{V_{IN} \times (V_{OUT} - V_{IN})}{V_{OUT}} \quad (2)$$

Choosing inductor values higher than 4.7 μH can improve efficiency due to reduced switching frequency and therefore with reduced switching losses. Using inductor values below 2.2 μH is not recommended.

Having selected an inductance value, the peak current for the inductor in steady state operation can be calculated. [Equation 3](#) gives the peak current estimate.

$$I_{L,MAX} = \begin{cases} \frac{V_{OUT} \times I_{OUT}}{0.8 \times V_{IN}} + 100 \text{ mA}; & \text{continuous current operation} \\ 200 \text{ mA}; & \text{discontinuous current operation} \end{cases} \quad (3)$$

For selecting the inductor this would be the suitable value for the current rating. It also needs to be taken into account that load transients and error conditions may cause higher inductor currents.

[Equation 4](#) provides an easy way to estimate whether the device will work in continuous or discontinuous operation depending on the operating points. As long as the inequation is true, continuous operation is typically established. If the inequation becomes false, discontinuous operation is typically established.

$$\frac{V_{OUT} \times I_{OUT}}{V_{IN}} > 0.8 \times 100 \text{ mA} \quad (4)$$

The following inductor series from different suppliers have been used with TPS6122x converters:

Table 1. List of Inductors

VENDOR	INDUCTOR SERIES
Coilcraft	EPL3015
	EPL2010
Murata	LQH3NP
Tajo Yuden	NR3015
Würth Elektronik	WE-TPC Typ S

Capacitor Selection

Input Capacitor

At least a 10-μF input capacitor is recommended to improve transient behavior of the regulator and EMI behavior of the total power supply circuit. A ceramic capacitor placed as close as possible to the VIN and GND pins of the IC is recommended.

Output Capacitor

For the output capacitor C_2 , it is recommended to use small ceramic capacitors placed as close as possible to the VOUT and GND pins of the IC. If, for any reason, the application requires the use of large capacitors which can not be placed close to the IC, the use of a small ceramic capacitor with a capacitance value of around 2.2μF in parallel to the large one is recommended. This small capacitor should be placed as close as possible to the VOUT and GND pins of the IC.

A minimum capacitance value of 4.7 μF should be used, 10 μF are recommended. If the inductor value exceeds 4.7 μH , the value of the output capacitance value needs to be half the inductance value or higher for stability reasons, see [Equation 5](#).

$$C_2 \geq \frac{L}{2} \times \frac{\mu\text{F}}{\mu\text{H}} \quad (5)$$

The TPS6122x is not sensitive to the ESR in terms of stability. Using low ESR capacitors, such as ceramic capacitors, is recommended anyway to minimize output voltage ripple. If heavy load changes are expected, the output capacitor value should be increased to avoid output voltage drops during fast load transients.

Layout Considerations

As for all switching power supplies, the layout is an important step in the design, especially at high peak currents and high switching frequencies. If the layout is not carefully done, the regulator could show stability problems as well as EMI problems. Therefore, use wide and short traces for the main current path and for the power ground paths. The input and output capacitor, as well as the inductor should be placed as close as possible to the IC.

The feedback divider should be placed as close as possible to the control ground pin of the IC. To lay out the ground, it is recommended to use short traces as well, separated from the power ground traces. This avoids ground shift problems, which can occur due to superimposition of power ground current and control ground current. Assure that the ground traces are connected close to the device GND pin.

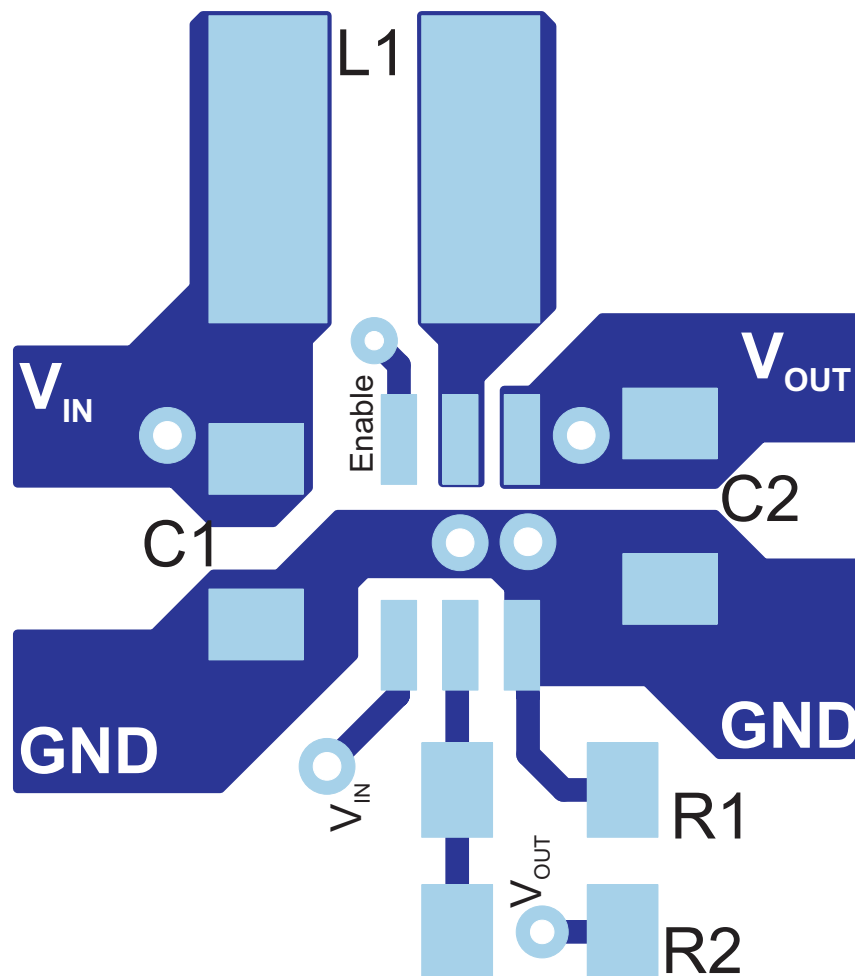

Figure 26. PCB Layout Suggestion for Adjustable Output Voltage Options

THERMAL INFORMATION

Implementation of integrated circuits in low-profile and fine-pitch surface-mount packages typically requires special attention to power dissipation. Many system-dependent issues such as thermal coupling, airflow, added heat sinks and convection surfaces, and the presence of other heat-generating components affect the power-dissipation limits of a given component.

Three basic approaches for enhancing thermal performance are listed below.

- Improving the power-dissipation capability of the PCB design
- Improving the thermal coupling of the component to the PCB
- Introducing airflow in the system

For more details on how to use the thermal parameters in the dissipation ratings table please check the [Thermal Characteristics Application Note \(SZZA017\)](#) and the [IC Package Thermal Metrics Application Note \(SPRA953\)](#).

PACKAGING INFORMATION

Orderable Device	Status ⁽¹⁾	Package Type	Package Drawing	Pins	Package Qty	Eco Plan ⁽²⁾	Lead/Ball Finish	MSL Peak Temp ⁽³⁾
TPS61220DCKR	ACTIVE	SC70	DCK	6	3000	Green (RoHS & no Sb/Br)	CU NIPDAU	Level-1-260C-UNLIM
TPS61220DCKT	ACTIVE	SC70	DCK	6	250	Green (RoHS & no Sb/Br)	CU NIPDAU	Level-1-260C-UNLIM
TPS61221DCKR	ACTIVE	SC70	DCK	6	3000	Green (RoHS & no Sb/Br)	CU NIPDAU	Level-1-260C-UNLIM
TPS61221DCKT	ACTIVE	SC70	DCK	6	250	Green (RoHS & no Sb/Br)	CU NIPDAU	Level-1-260C-UNLIM
TPS61222DCKR	ACTIVE	SC70	DCK	6	3000	Green (RoHS & no Sb/Br)	CU NIPDAU	Level-1-260C-UNLIM
TPS61222DCKT	ACTIVE	SC70	DCK	6	250	Green (RoHS & no Sb/Br)	CU NIPDAU	Level-1-260C-UNLIM

⁽¹⁾ The marketing status values are defined as follows:

ACTIVE: Product device recommended for new designs.

LIFEBUY: TI has announced that the device will be discontinued, and a lifetime-buy period is in effect.

NRND: Not recommended for new designs. Device is in production to support existing customers, but TI does not recommend using this part in a new design.

PREVIEW: Device has been announced but is not in production. Samples may or may not be available.

OBSOLETE: TI has discontinued the production of the device.

⁽²⁾ Eco Plan - The planned eco-friendly classification: Pb-Free (RoHS), Pb-Free (RoHS Exempt), or Green (RoHS & no Sb/Br) - please check <http://www.ti.com/productcontent> for the latest availability information and additional product content details.

TBD: The Pb-Free/Green conversion plan has not been defined.

Pb-Free (RoHS): TI's terms "Lead-Free" or "Pb-Free" mean semiconductor products that are compatible with the current RoHS requirements for all 6 substances, including the requirement that lead not exceed 0.1% by weight in homogeneous materials. Where designed to be soldered at high temperatures, TI Pb-Free products are suitable for use in specified lead-free processes.

Pb-Free (RoHS Exempt): This component has a RoHS exemption for either 1) lead-based flip-chip solder bumps used between the die and package, or 2) lead-based die adhesive used between the die and leadframe. The component is otherwise considered Pb-Free (RoHS compatible) as defined above.

Green (RoHS & no Sb/Br): TI defines "Green" to mean Pb-Free (RoHS compatible), and free of Bromine (Br) and Antimony (Sb) based flame retardants (Br or Sb do not exceed 0.1% by weight in homogeneous material)

⁽³⁾ MSL, Peak Temp. -- The Moisture Sensitivity Level rating according to the JEDEC industry standard classifications, and peak solder temperature.

Important Information and Disclaimer: The information provided on this page represents TI's knowledge and belief as of the date that it is provided. TI bases its knowledge and belief on information provided by third parties, and makes no representation or warranty as to the accuracy of such information. Efforts are underway to better integrate information from third parties. TI has taken and continues to take reasonable steps to provide representative and accurate information but may not have conducted destructive testing or chemical analysis on incoming materials and chemicals. TI and TI suppliers consider certain information to be proprietary, and thus CAS numbers and other limited information may not be available for release.

In no event shall TI's liability arising out of such information exceed the total purchase price of the TI part(s) at issue in this document sold by TI to Customer on an annual basis.

TAPE AND REEL INFORMATION
REEL DIMENSIONS

TAPE DIMENSIONS

A0	Dimension designed to accommodate the component width
B0	Dimension designed to accommodate the component length
K0	Dimension designed to accommodate the component thickness
W	Overall width of the carrier tape
P1	Pitch between successive cavity centers

TAPE AND REEL INFORMATION

*All dimensions are nominal

Device	Package Type	Package Drawing	Pins	SPQ	Reel Diameter (mm)	Reel Width W1 (mm)	A0 (mm)	B0 (mm)	K0 (mm)	P1 (mm)	W (mm)	Pin1 Quadrant
TPS61220DCKR	SC70	DCK	6	3000	179.0	8.4	2.2	2.5	1.2	4.0	8.0	Q3
TPS61220DCKT	SC70	DCK	6	250	179.0	8.4	2.2	2.5	1.2	4.0	8.0	Q3
TPS61221DCKR	SC70	DCK	6	3000	179.0	8.4	2.2	2.5	1.2	4.0	8.0	Q3
TPS61221DCKT	SC70	DCK	6	250	179.0	8.4	2.2	2.5	1.2	4.0	8.0	Q3
TPS61222DCKR	SC70	DCK	6	3000	179.0	8.4	2.2	2.5	1.2	4.0	8.0	Q3
TPS61222DCKT	SC70	DCK	6	250	179.0	8.4	2.2	2.5	1.2	4.0	8.0	Q3

TAPE AND REEL BOX DIMENSIONS

*All dimensions are nominal

Device	Package Type	Package Drawing	Pins	SPQ	Length (mm)	Width (mm)	Height (mm)
TPS61220DCKR	SC70	DCK	6	3000	203.0	203.0	35.0
TPS61220DCKT	SC70	DCK	6	250	203.0	203.0	35.0
TPS61221DCKR	SC70	DCK	6	3000	203.0	203.0	35.0
TPS61221DCKT	SC70	DCK	6	250	203.0	203.0	35.0
TPS61222DCKR	SC70	DCK	6	3000	203.0	203.0	35.0
TPS61222DCKT	SC70	DCK	6	250	203.0	203.0	35.0

DCK (R-PDSO-G6)

PLASTIC SMALL-OUTLINE PACKAGE



- NOTES:
- A. All linear dimensions are in millimeters.
 - B. This drawing is subject to change without notice.
 - C. Body dimensions do not include mold flash or protrusion. Mold flash and protrusion shall not exceed 0.15 per side.
 - D. Falls within JEDEC MO-203 variation AB.

DCK (R-PDSO-G6)

PLASTIC SMALL OUTLINE



- NOTES:
- A. All linear dimensions are in millimeters.
 - B. This drawing is subject to change without notice.
 - C. Customers should place a note on the circuit board fabrication drawing not to alter the center solder mask defined pad.
 - D. Publication IPC-7351 is recommended for alternate designs.
 - E. Laser cutting apertures with trapezoidal walls and also rounding corners will offer better paste release. Customers should contact their board assembly site for stencil design recommendations. Example stencil design based on a 50% volumetric metal load solder paste. Refer to IPC-7525 for other stencil recommendations.

IMPORTANT NOTICE

Texas Instruments Incorporated and its subsidiaries (TI) reserve the right to make corrections, modifications, enhancements, improvements, and other changes to its products and services at any time and to discontinue any product or service without notice. Customers should obtain the latest relevant information before placing orders and should verify that such information is current and complete. All products are sold subject to TI's terms and conditions of sale supplied at the time of order acknowledgment.

TI warrants performance of its hardware products to the specifications applicable at the time of sale in accordance with TI's standard warranty. Testing and other quality control techniques are used to the extent TI deems necessary to support this warranty. Except where mandated by government requirements, testing of all parameters of each product is not necessarily performed.

TI assumes no liability for applications assistance or customer product design. Customers are responsible for their products and applications using TI components. To minimize the risks associated with customer products and applications, customers should provide adequate design and operating safeguards.

TI does not warrant or represent that any license, either express or implied, is granted under any TI patent right, copyright, mask work right, or other TI intellectual property right relating to any combination, machine, or process in which TI products or services are used. Information published by TI regarding third-party products or services does not constitute a license from TI to use such products or services or a warranty or endorsement thereof. Use of such information may require a license from a third party under the patents or other intellectual property of the third party, or a license from TI under the patents or other intellectual property of TI.

Reproduction of TI information in TI data books or data sheets is permissible only if reproduction is without alteration and is accompanied by all associated warranties, conditions, limitations, and notices. Reproduction of this information with alteration is an unfair and deceptive business practice. TI is not responsible or liable for such altered documentation. Information of third parties may be subject to additional restrictions.

Resale of TI products or services with statements different from or beyond the parameters stated by TI for that product or service voids all express and any implied warranties for the associated TI product or service and is an unfair and deceptive business practice. TI is not responsible or liable for any such statements.

TI products are not authorized for use in safety-critical applications (such as life support) where a failure of the TI product would reasonably be expected to cause severe personal injury or death, unless officers of the parties have executed an agreement specifically governing such use. Buyers represent that they have all necessary expertise in the safety and regulatory ramifications of their applications, and acknowledge and agree that they are solely responsible for all legal, regulatory and safety-related requirements concerning their products and any use of TI products in such safety-critical applications, notwithstanding any applications-related information or support that may be provided by TI. Further, Buyers must fully indemnify TI and its representatives against any damages arising out of the use of TI products in such safety-critical applications.

TI products are neither designed nor intended for use in military/aerospace applications or environments unless the TI products are specifically designated by TI as military-grade or "enhanced plastic." Only products designated by TI as military-grade meet military specifications. Buyers acknowledge and agree that any such use of TI products which TI has not designated as military-grade is solely at the Buyer's risk, and that they are solely responsible for compliance with all legal and regulatory requirements in connection with such use.

TI products are neither designed nor intended for use in automotive applications or environments unless the specific TI products are designated by TI as compliant with ISO/TS 16949 requirements. Buyers acknowledge and agree that, if they use any non-designated products in automotive applications, TI will not be responsible for any failure to meet such requirements.

Following are URLs where you can obtain information on other Texas Instruments products and application solutions:

Products

Audio	www.ti.com/audio
Amplifiers	amplifier.ti.com
Data Converters	dataconverter.ti.com
DLP® Products	www.dlp.com
DSP	dsp.ti.com
Clocks and Timers	www.ti.com/clocks
Interface	interface.ti.com
Logic	logic.ti.com
Power Mgmt	power.ti.com
Microcontrollers	microcontroller.ti.com
RFID	www.ti-rfid.com
OMAP Mobile Processors	www.ti.com/omap
Wireless Connectivity	www.ti.com/wirelessconnectivity

Applications

Communications and Telecom	www.ti.com/communications
Computers and Peripherals	www.ti.com/computers
Consumer Electronics	www.ti.com/consumer-apps
Energy and Lighting	www.ti.com/energy
Industrial	www.ti.com/industrial
Medical	www.ti.com/medical
Security	www.ti.com/security
Space, Avionics and Defense	www.ti.com/space-avionics-defense
Transportation and Automotive	www.ti.com/automotive
Video and Imaging	www.ti.com/video

TI E2E Community Home Page

e2e.ti.com

Mailing Address: Texas Instruments, Post Office Box 655303, Dallas, Texas 75265
Copyright © 2011, Texas Instruments Incorporated