

Automotive Direction Indicator

IL33193

The IL33193 is a new generation industry standard UAA1041 “Flasher”. It has been developed for enhanced EMI sensitivity, system reliability, and improved wiring simplification. The IL33193 is pin compatible with the UAA1041 and UAA1041B in the standard application configuration as shown in Figure 9, without lamp short circuit detection and using a 20 mΩ shunt resistor. The IL33193 has a standby mode of operation requiring very low standby supply current and can be directly connected to the vehicle’s battery. It includes an RF filter on the Fault detection pin (Pin 7) for EMI purposes. Fault detection thresholds are reduced relative to those of the UAA1041, allowing a lower shunt resistance value (20 mW) to be used.

- Pin Compatible with the UAA1041
- Defective Lamp Detection Threshold
- RF Filter for EMI Purposes
- Load Dump Protection
- Double Battery Capability for Jump Start

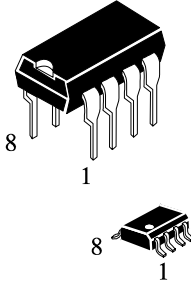

N SUFFIX PLASTIC

D SUFFIX SOIC

ORDERING INFORMATION

IL33193N	DIP
IL33193D	SOIC

T_A = -40° to 125°C for all packages

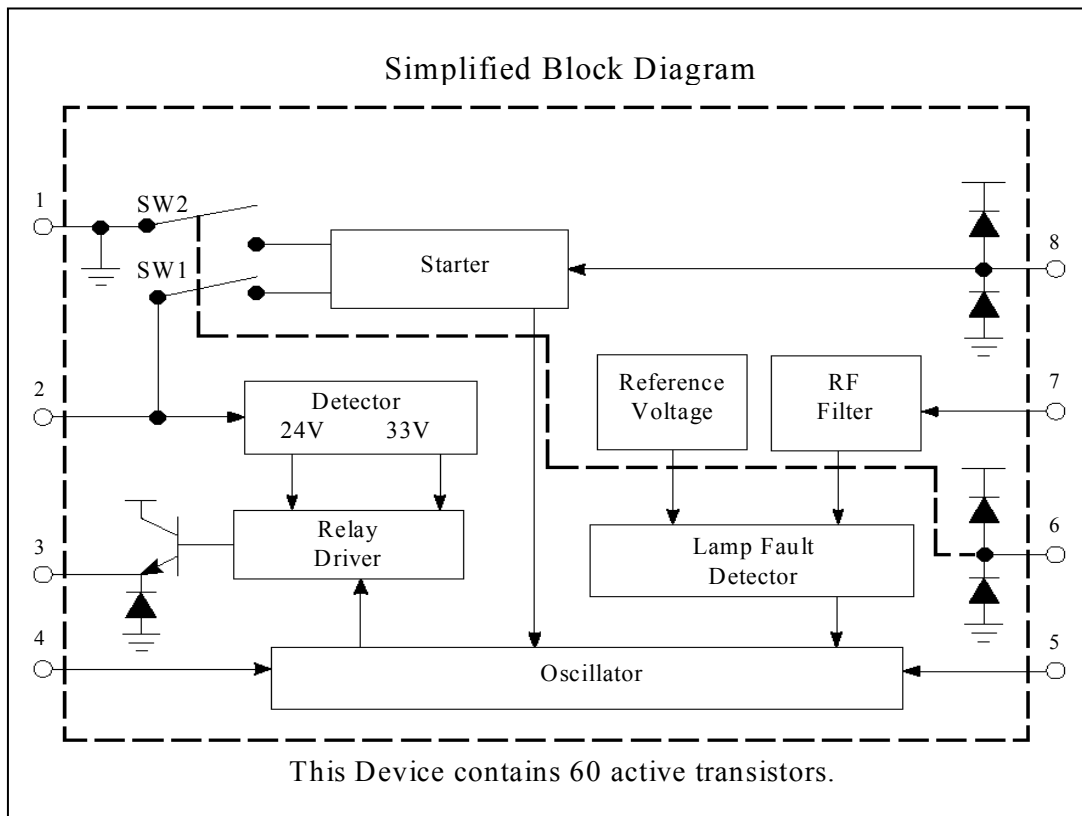
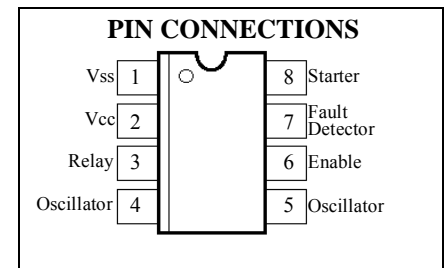

MAXIMUM RATINGS*

Rating	Symbol	Value	Unit
Pin1 Positive Current (Continuous/Pulse)	I1+	150 to 500	mA
Pin1 Negative Current (Continuous/Pulse)	I1-	-35 to -500	mA
Current (Continuous/Pulse)	I2	±350 to ±1900	mA
Current (Continuous/Pulse)	I3	±300 to ±1400	mA
Current (Continuous/Pulse)	I8	±25 to ±50	mA
ESD(Aii Pins Except Pin4 for Negative Pulse)	V _{ESD}	±2000	°V
ESD(Pin 4 Negative Pulse)	V _{ESD4-}	-1000	°V
Junction Temperature	T _J	150	°C
Operation Ambient Temperature Range	T _A	-40 to +125	°C
Storage Temperature Range	T _{STG}	-65 to +150	°C

ELECTRICAL CHARACTERISTICS (-45°C ≤ T_A ≤ +125 °C, 8.0 V ≤ V_{CC} ≤ 18.0 V, unless otherwise noted. Typical values reflect approximate mean at T_A = 25 °C, V_{CC} = 14 V at the time of initial device characterization.)

Characteristic	Symbol	Min	Max	Unit
Battery Voltage Range (Normal Operation)	V _b	8.0	18	V
Overvoltage Detector Threshold (V _{Pin2} - V _{Pin1})	V _{ih}	19	22	V
Clamping Voltage (R2 = 220 Ω)	V _{cl}	27	34	V
Output Voltage [I = -250 mA (V _{Pin2} - V _{Pin3})]	V _{sat}	-	1.5	V
Starter Resistance (R _{st} = R2 + R _{Lamp})	R _{st}	-	3.6	kΩ
Oscillator Constant (Normal Operation, T _A = 25 °C)	K _n	1.3	1.75	
Temperature Coefficient of K _n	TC _{Kn}	-	-	1/°C
Duty Cycle (Normal Operation)	-	45	55	%
Oscillator Constant (One 21 W Lamp Defect, T _A = 25 °C)	K _f	0.59	0.75	
Duty Cycle(One 21 W Lamp Defect)	-	35	45	%
Oscillator Constant (T _A = 25 °C)	K1 K2	0.150 0.200	0.240 0.290	
Standby Current (Ignition «Off»)	I _{CC}	-	100	μA
Current Consumption (Relay «Off», Enable Pin 6 High) V _{bat} = 13.5 V, R3 = 220 Ω	I _{CC}	-	3.5	mA
Current Consumption (Relay «On») V _{bat} = 13.5 V, R3 = 220 Ω	I _{CC}	-	6.0	mA
Defect Lamp Detector [R3 = 220 Ω, (V _{Pin2} - V _{Pin7})] V _{bat} = 13.5 V	V _s	42.5	56	mV

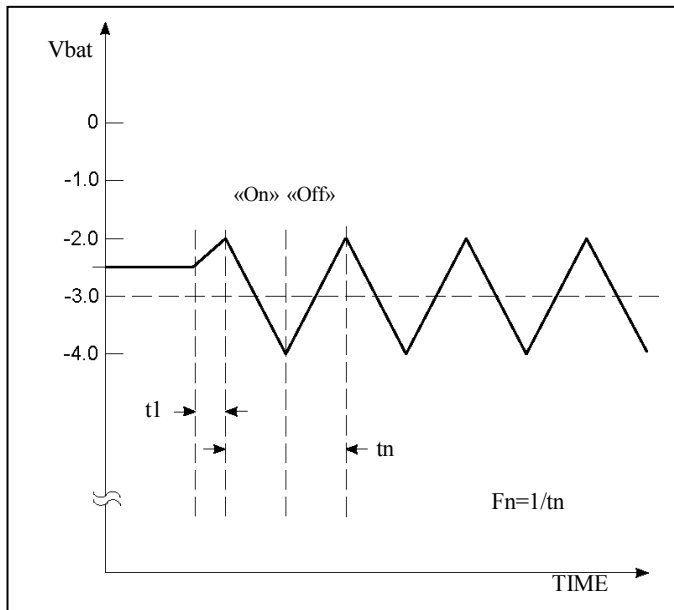

Figure 1 - Normal Operation Oscillator Timing Diagram

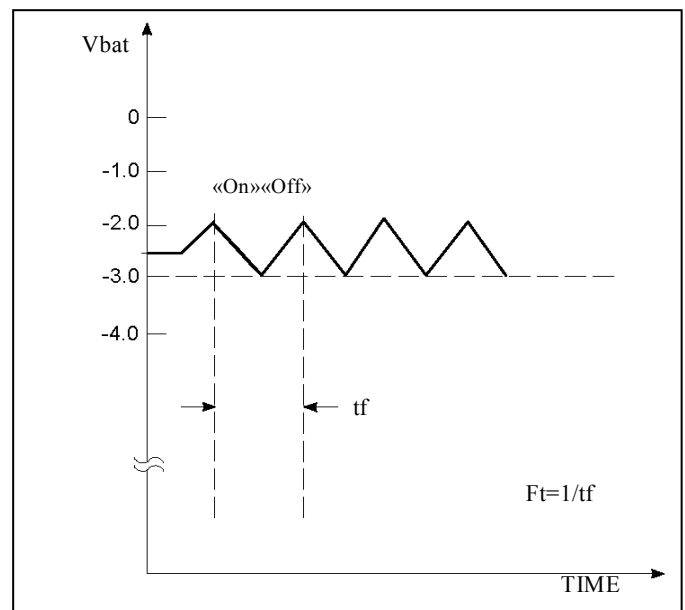

Figure 2 - One Defective Lamp Oscillator Timing Diagram

INTRODUCTION

The IL33193 is designed to drive the direction indicator flasher relay. It is a new generation industry standard UAA1041 “Flasher”. It consists of the following functions:

- Supply and Protections
- On–Chip Relay Driver
- Oscillator
- Starter Functions
- Lamp Fault Detector with Internal RF Filter
- Standby Mode

Supply and Protection Systems

Pin 1 is connected to ground via resistor R3 which limits the current in the event of any high voltage transients. Pin 2 (VCC) is the positive supply and may be connected directly to the vehicle’s battery voltage. Overvoltage and Double Battery Protection: When the applied VCC to VSS voltage is greater than 22 V, the overvoltage detector circuit turns the relay driver off. Both the device and the lamps are protected if two 12 V batteries are connected in series and used to jump start the vehicle. Load Dump Overvoltage Protection: A 29 V overvoltage detector protects the circuits against high voltage transients due to load dumps and other low energy spikes. The relay driver is automatically turned on whenever the VCC to VSS voltage is greater than 34 V. Overvoltage Protection, High Voltage Transients: The Enable and the Starter pins are protected against positive and negative transients by internal on–chip diodes.

On–Chip Relay Driver

The device directly drives the flasher relay. The output structure is an Emitter of an NPN transistor. It contains the free wheeling diode circuitry necessary to protect the device whenever the relay is switched off.

Oscillator

The device uses a sawtooth oscillator (Figure 1). The frequency is determined by the external components C1 and R1. In the normal operating mode, the flashing frequency is: $F_n = 1/R1 \cdot C1 \cdot K_n$. With a defective (open) 21 W lamp (Figure 2), the flashing frequency changes to: $F_n = 2.2 \cdot F_n$.

The typical first flash delay (the time between the moment when the indicator switch is closed and the first lamp flash occurs) is: $t_1 = K_1 \cdot R1 \cdot C1$. The fault detection delay is from the time relay R1 is on and fault detection is enabled. Where a 21 W lamp opens, the delay is expressed as: $t_2 = K_2 \cdot R1 \cdot C1$

Starter

Pin 8 is connected through a 3.3 kW resistor to the flashing lamp. Pin 8 is the input to the Starter function and senses the use of S1 by sensing ground through the lamp (Figures 9 and 10).

Lamp Fault Detector with Internal RF Filter

A Lamp defect is sensed by the lamp fault detector's monitoring of the voltage developed across the external shunt resistor RS via the RF filter. The RS voltage drop is compared to a Vbat dependent internal reference voltage (Vref) to validate the comparison over the full battery voltage range. A detected fault causes the oscillator to change frequency (Figure 2).

Standby Mode

When the ignition key and warning switches are open; Enable is in a low state and the internal switches, SW1 and SW2, are open and no current passes through the circuit. In this condition, the device's current consumption is zero (ICC = 0). When ignition key and warning switches are closed; Enable is in a high state with SW1 and SW2 being closed and the circuit is powered on.

Main differences between UAA1041B & IL33193

The IL33193 is pin compatible with the UAA1041.

Supply Current

Supply current is more stable on the IL33193 when the device is in "on" or "off" state. In "on" state the supply current is only 40% higher than when in the "off" state, as compared to a ratio of 3 times for the UAA1041. This results in a lower voltage drop across the ground resistor R3 (see On-Chip Relay Driver).

Short Circuit Detection

The IL33193 has no short circuit detection.

Standby Mode (Pin 6)

The UAA1041 has no standby mode. Pin 6 is used as an Enable/Disable for the short circuit detection. The IL33193 uses Pin 6 to set the device in standby mode. If Pin 6 is connected to ground, the IL33193 is in the standby mode. In this mode, standby current is very low and Pin 8's starter resistor R2 and a 2.0 kW internal resistor are switched off. As soon as Pin 6 is at a high level (typical threshold = 2Vbe) the device becomes active. In the application, the IL33193 can be connected directly to the battery and awakened whenever Pin 6 is connected to the vehicle's battery by way of a protection resistor and the ignition key switch.

Lamp Defect Detection (Pin 7)

The UAA1041 operates with a 30 mW shunt resistor to sense the lamp current. Its lamp defect detection threshold of Pin 7 is typically 85 mV. The IL33193 is designed to operate with 20 mW shunt resistor and at a reduced threshold of 50 mV. This reduces power generation in the flasher module. In addition, the IL33193 incorporates an RF filter to enhance RFI immunity.

Load Dump and Overvoltage Behavior

The UAA1041 and IL33193 both behave the same in this regard. Both have double battery detection and lamp turn-off protection in the event of a jump start. During load dump, both devices are protected by an internal 30 V zener diode with the relay activated during a load dump.

Relay Driver

Drive capability of both devices is the same. Free wheeling diode protection is internal to both devices. The free wheeling voltage is 2Vbe for the UAA1041 and 3Vbe for the IL33193. This results in a higher clamp voltage across the relay and thus in a faster turn-off. In addition, the lower "on" state supply current is lower on the IL33193 and thus the voltage drop across the ground resistor R3 is reduced. This results in an even higher clamp voltage across the relay.

Oscillator Phase

The oscillator phase is opposite on the IL33193 as compared to the UAA1041. The Oscillator voltage is falling during "on" state and rising during "off" state for the IL33193.

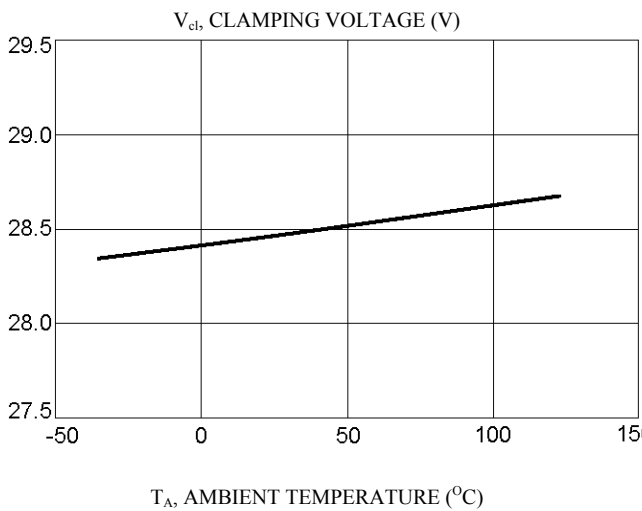

Figure 3 – Clamping Voltage versus Temperature

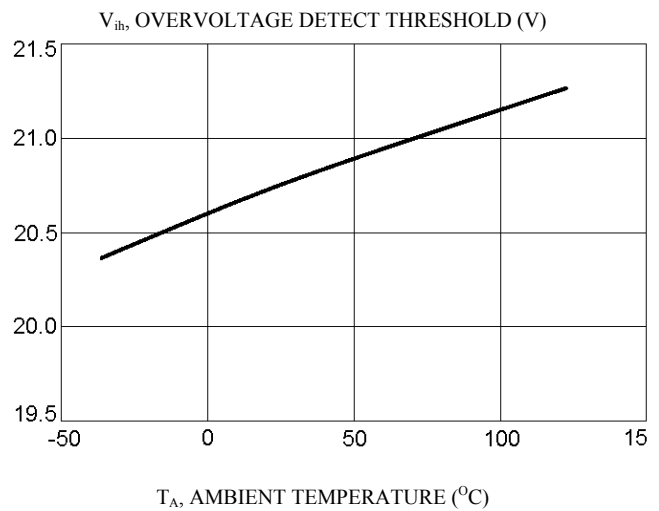

Figure 4 – Overvoltage Detector versus Temperature

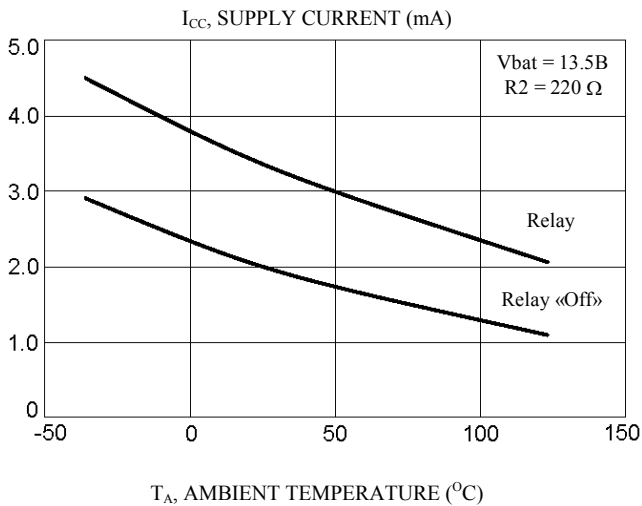

Figure 5 – Supply Current versus Temperature

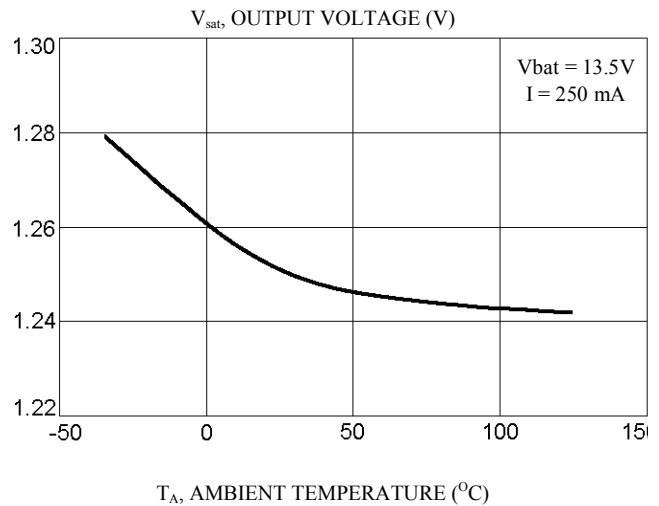

Figure 6 – Output Voltage versus Temperature

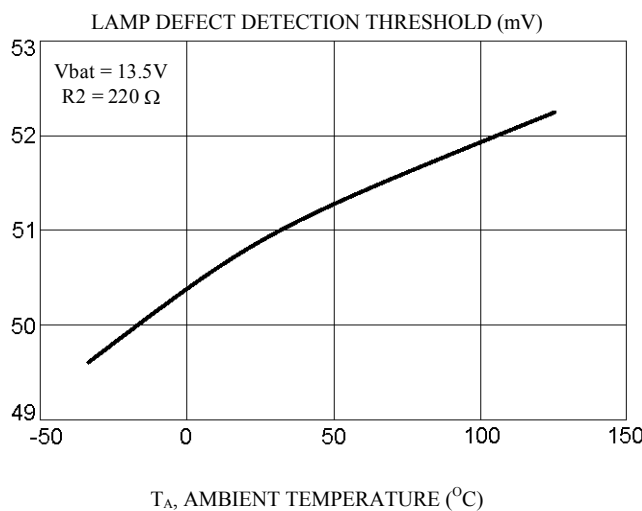

Figure 7 – Defect Lamp Detection versus Temperature

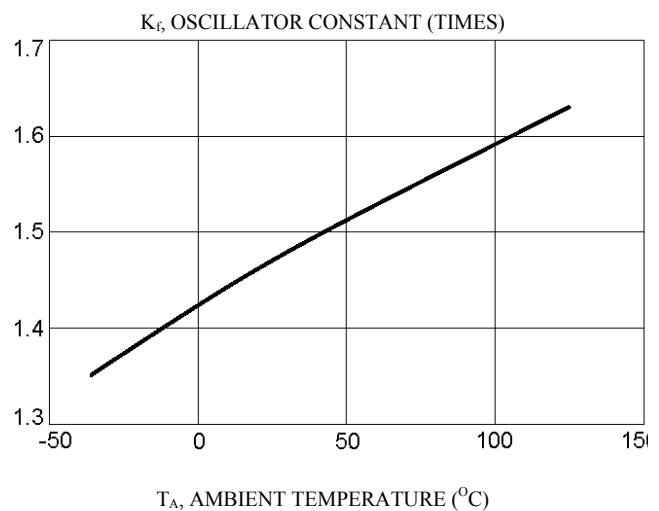
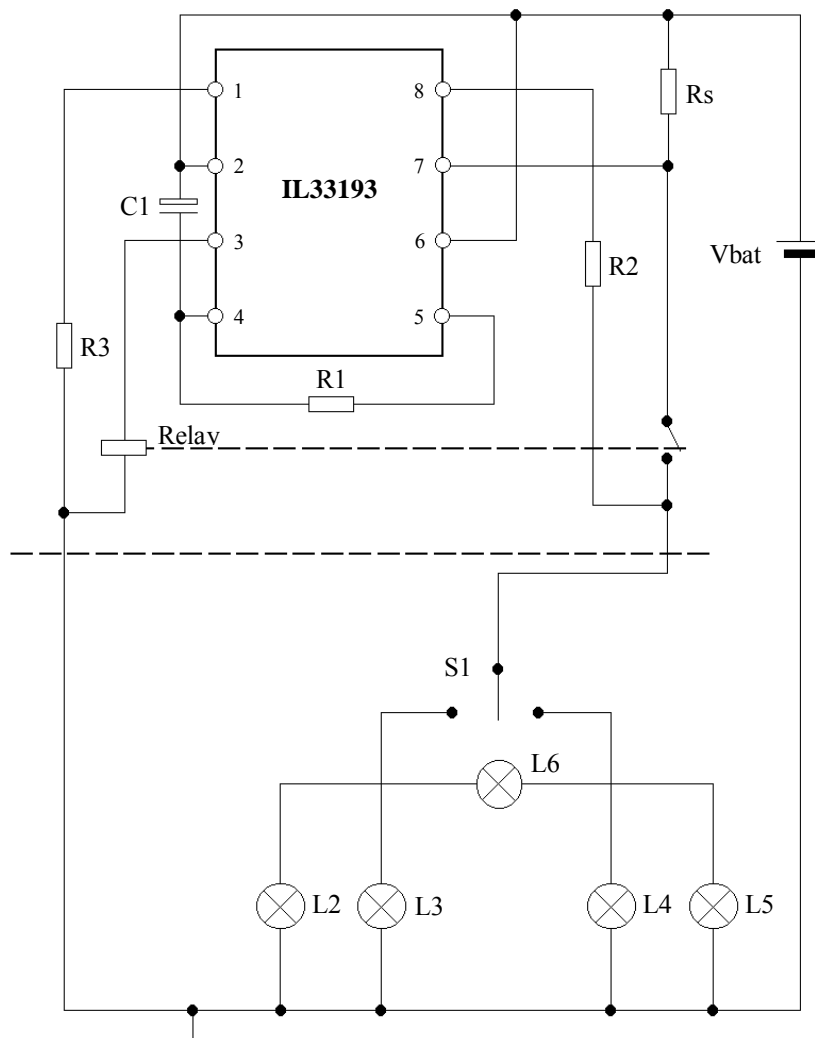

Figure 8 – Oscillator Constant versus Temperature



- $R_s = 20\text{ m}\Omega$
- $R_1 = 75\text{ k}\Omega$
- $C_1 = 5.6\text{ }\mu\text{F}$
- $R_2 = 3.3\text{ k}\Omega$
- $R_3 = 200\text{ }\Omega$
- L2, L3, L4, L5 = 21 W Tum Signal Lamps

Figure 9 - IL33193 Typical Application

Application Information

- NOTES:**
1. In the above application, the IL33193 is compatible with the UAA1041 and UAA1041B except for the shunt resistor value ($R_s = 20\text{ m}\Omega$).
 2. The flashing cycle is started by the closing of switch S1.
 3. The position of switch S1 is sensed across resistor R2 and R_{Lamp} by the input, Pin 8.

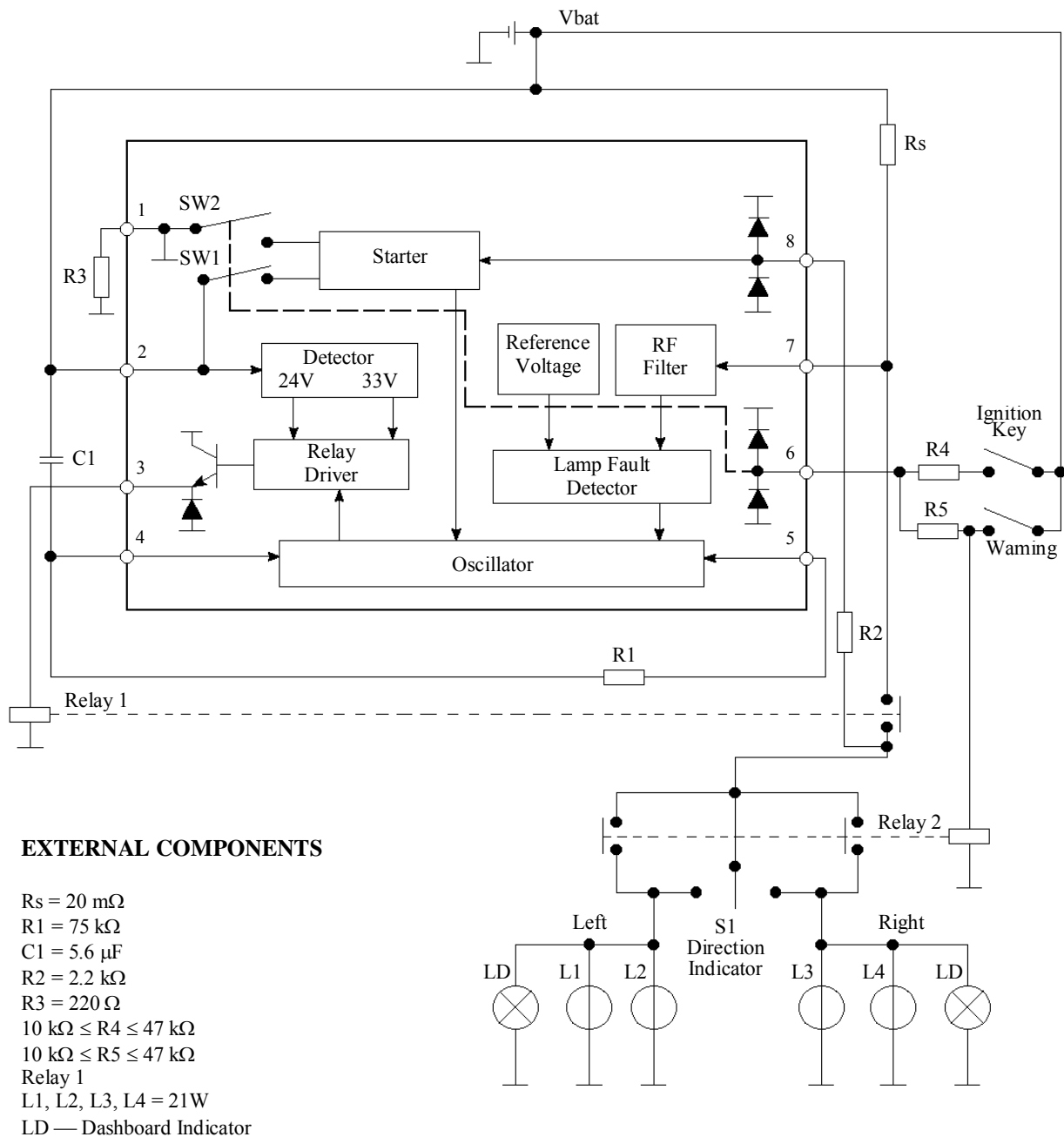
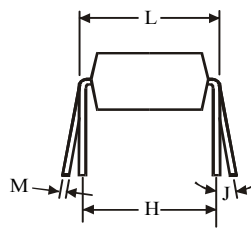
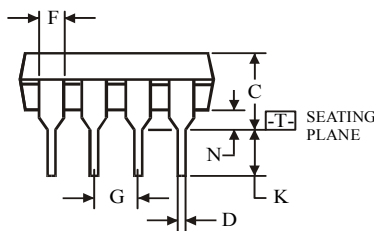
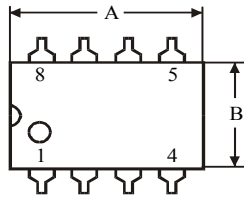
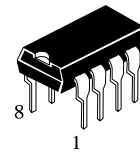

Figure 10. IL33193 Typical Application

Application Information

- Notes:**
1. The flashing cycle is started by the dosing of switch S1.
 2. The S1 switch position is sensed across the resistor R_2 and R_{LAMP} by the input (Pin8).
 3. If the logic state at Pin6 is [0], the current through R_2 is off.

**N SUFFIX PLASTIC DIP
(MS - 001BA)**



$\oplus 0.25 (0.010) \text{ (M) T}$

Symbol	Dimension, mm	
	MIN	MAX
A	8.51	10.16
B	6.1	7.11
C		5.33
D	0.36	0.56
F	1.14	1.78
G	2.54	
H	7.62	
J	0°	10°
K	2.92	3.81
L	7.62	8.26
M	0.2	0.36
N	0.38	

NOTES:

- Dimensions "A", "B" do not include mold flash or protrusions.
Maximum mold flash or protrusions 0.25 mm (0.010) per side.

**D SUFFIX SOIC
(MS - 012AA)**

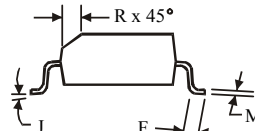
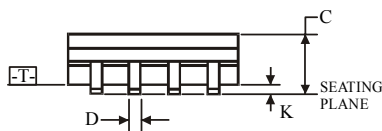
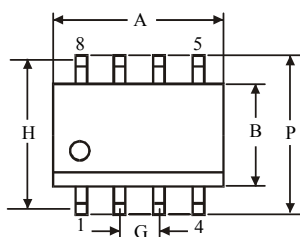
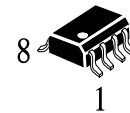

$\oplus 0.25 (0.010) \text{ (M) T C (M)}$

Symbol	Dimension, mm	
	MIN	MAX
A	4.8	5
B	3.8	4
C	1.35	1.75
D	0.33	0.51
F	0.4	1.27
G	1.27	
H	5.72	
J	0°	8°
K	0.1	0.25
M	0.19	0.25
P	5.8	6.2
R	0.25	0.5

NOTES:

- Dimensions A and B do not include mold flash or protrusion.
- Maximum mold flash or protrusion 0.15 mm (0.006) per side for A; for B - 0.25 mm (0.010) per side.