

5



4

3

2

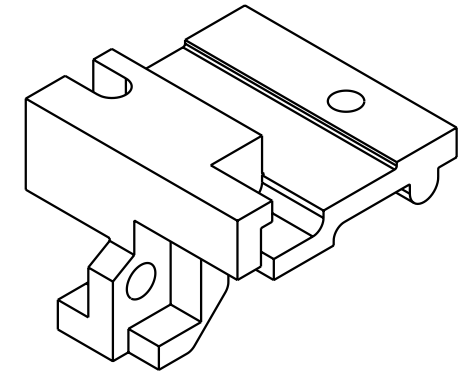
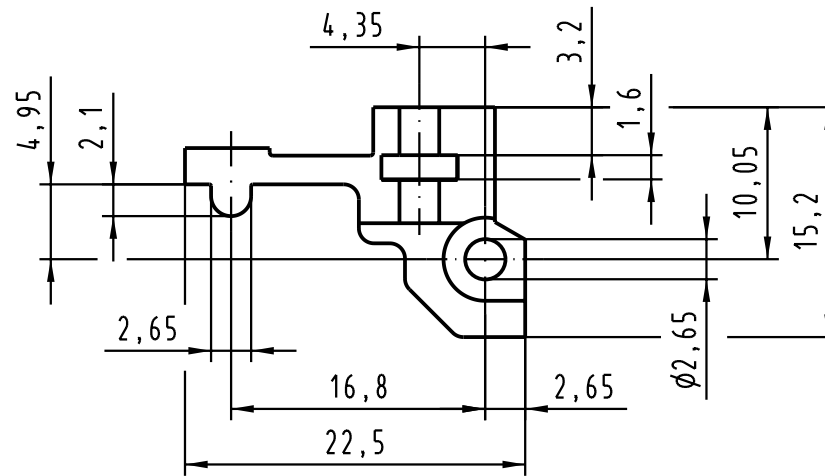
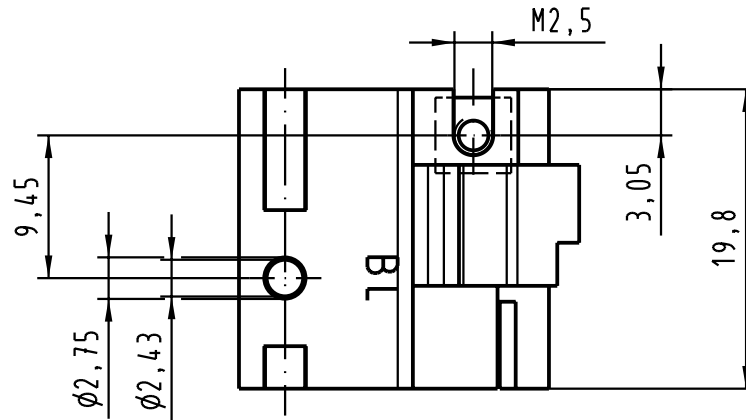
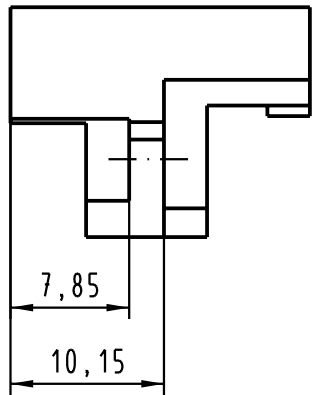
1

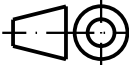

 All Dimensions in mm Original Size DIN A 4		Techn. Character.			Nicht tolerierte Maß/Free size tolerances	
			Dat.	Name	Maßstab/Scale 2:1	Rastelement BL 20mm metallisiert (Oberfläche: Ni) fixing bracket BL 20mm metallised (surface: Ni)
		Detail.	23.03.04	Hage.		
		Insp.	23.03.04	Sch.		
		Stand.				
31980		HARTING Electronics GmbH & Co. KG D-32339 ESPELKAMP			TB 09 06 901 9924	
Mod.	Dat.	Name			Sub.	Blatt/page 

D

C

B

A