

Female Terminal

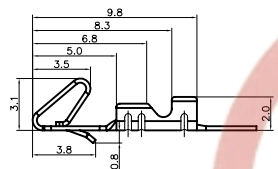

Female Terminal

Wire Range		O.D of Wire
Section Area (mm ²)	AWG#	mm
0.2~0.75	24~18	1.2~2.1

Female Housing

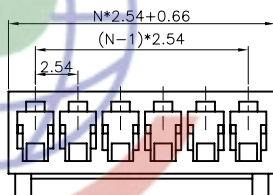
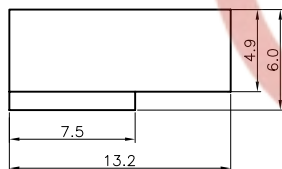

Male Right Angle

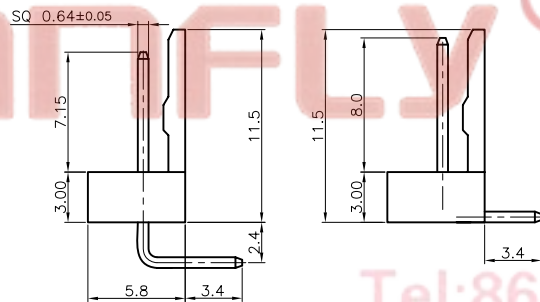
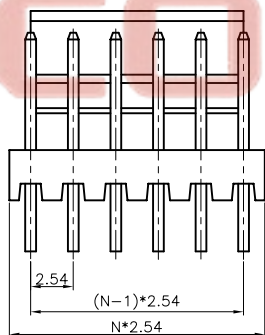

Type A

Type B

Male V/T TYPE

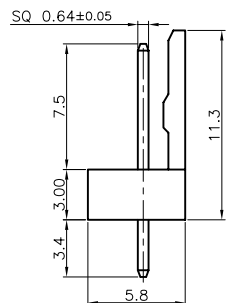
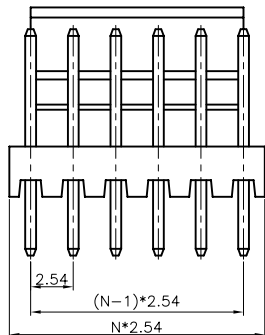

N=NO. OF CONTACTS

REV.	DESCRIPTION	DRAWN	CHECKED	APPROVED
A	NEW RELEASE	YCH 06/27/08'	~	

NOTES:

1. MAIN SPECIFICATIONS

- . Housing material: NYLON 66
- . Wires range: AWG#24~#18
- . Rated voltage: 250V
- . Rated current: 1A
- . Contact resistance: ≤ 30mΩ
- . Insulation resistance: ≥ 1000MΩ
- . Withstanding voltage: 500V,AC 1 minute
- . Temperature range: -25 ~ +85°C

2. PRODUCT NUMBER CODE:

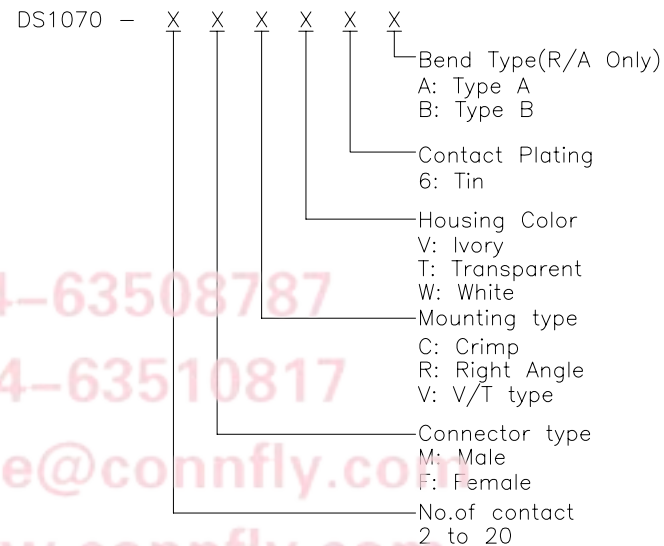

Tel:86-574-63508787

Fax:86-574-63510817

E-mail:sale@connfly.com

http://www.connfly.com

Add:East Industry Zone KuangYan

Town Ciyi Ningbo China

P.O.015333

GENERAL TOLERANCE		ANGLE TOLERANCE		PROJECTION	TITLE
X.	±0.60	X.	±5°	UNITS	P.C.B CONNECTOR Pitch 2.54mm
.X	±0.38	.X	±3°	SHEET SIZE	A4 SERIES DS1070
.XX	±0.25	.XX	±2°		
DRAWING TYPE	CUSTOMER	晨翔电子有限公司 CONNFLY CONNFLY ELECTRONIC CO., LTD			
SCALE	1:1 SHEET 1 OF 1				
DRAWING NO.	C-DS1070-XXXXXX				