

Contents	7
Selector Guide	
Alphanumeric Index of Types	
<hr/>	
General Technical Information	27
<hr/>	
IF Filters for Intercarrier Applications	47
<hr/>	
IF Filters for Quasi/Split Sound Applications	115
<hr/>	
IF Filters for Video Applications	181
<hr/>	
IF Filters for Audio Applications	217
<hr/>	
Satellite Filters	247
<hr/>	
Vestigial Sideband Filters	273
<hr/>	
Spectrum-Shaping Filters	293
<hr/>	
Bandpass Filters	303
<hr/>	
Clock Recovery Filters	325
<hr/>	
Resonators	333
<hr/>	
Low-Loss Filters for Mobile Communication	on request
<hr/>	
Symbols and Terms	347
Subject Index	350

SIEMENS

SCS on the Internet

Creating new links

As of now you can tie up with Passive Components and Electron Tubes Group plus Siemens Matsushita Components on the Internet. On our home page under

<http://www.siemens.de/pr/index.htm>

you'll find the latest short form catalogs, data books, technical articles and more subjects too. You can view the documents on-line, or download them to your PC. The "Installation" menu item tells you how to do it. Thanks to the integrated search function, you only have to enter key terms to go straight to the right document. And of course, you can get in touch with us direct by E mail at any time.

SCS – dependable, fast and competent

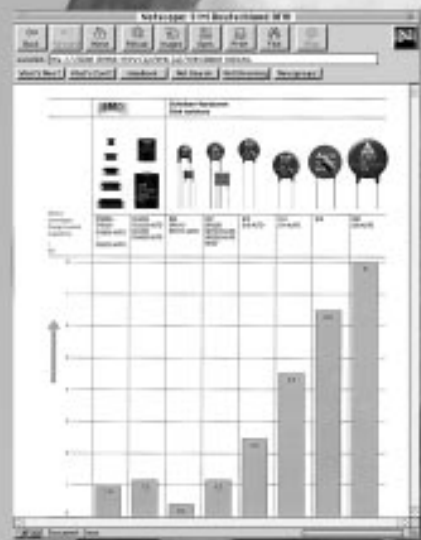

SAW Components



Siemens Matsushita Components

Siemens filters from stock

Ready, steady, go

SCS has 100,000 SIFI filters in stock, ready to go as soon as your order arrives. We offer a big selection through all the many variants, ie



building-block system, different attenuation characteristics and packages, various kinds of leads and current ratings from 1 through 20 A.

SCS – dependable, fast and competent



Preface

Surface acoustic wave (SAW) components from Siemens Matsushita Components rank among the key devices of modern information and communication technology. Fabricated in submicron technologies they are high-tech devices that feature not only outstanding precision, but also small size, high reproducibility and excellent long-term stability.

SAW components are used as bandpass filters, as frequency-stabilizing devices and for complex signal processing functions. The following summary gives you a survey of our product line and points out the benefits of the individual filter groups.

- **Intercarrier, quasi/split sound, video and audio filters**

Sophisticated design and production processes create extremely high precision in the passband and excellent adjacent-channel selectivity. As a consequence no cost-intensive matching elements and extra traps are necessary. Switchable SAW filters for multistandard applications enable switching of the transfer function for different TV standards. These filters come in miniaturized plastic packages (SIP 5 K and DIP 10 K) ready for automatic processing.

- **Satellite filters**

Satellite filters are applied in analog and digital satellite receivers for channel filtering on the IF level. Dual-channel filters allow the reception of signals from two satellites with different transponder bandwidths. Yet another benefit is switchover when reception deteriorates in poor weather like rain and snow. The smaller bandwidth means better signal/noise ratio and higher selectivity – and thus much improved picture and sound reproduction.

- **Bandpass, vestigial sideband and spectrum-shaping filters**

Telecommunications makes high demands: precise bandpass characteristics, flat passbands, steep skirts and high selectivity. SAW filters offer the tailored solution. They are used as bandpass filters in digital satellite and cable receivers, as vestigial sideband filters in TV transmitters, cable headends and transposers, and for spectrum shaping in digital radio relay systems.

- **Clock recovery filters**

In digital telecommunications, on coaxial copper or fiber-optic cable, the signal has to be regenerated at regular intervals to avoid bit errors. For this S+M Components offers standard SAW filters for the frequency range 50 through 2500 MHz, assuring reliable clock recovery even at high transmission rates.

- **Resonators**

SAW resonators are key components in remote control and telemetry systems. They are used in heating energy controllers, garage door openers and keyless entry systems for cars, to name just a few examples. SAW resonators work in the fundamental mode, from 200 through 900 MHz, allowing small and highly stable oscillator circuits. They come in hermetically sealed TO 39 or SMD packages, as one-port and two-port resonators, covering all common frequencies.

- **Low-loss filters for mobile communication**

For designers of cellular and cordless phones, low weight and low space requirements are the outstanding advantages of SAW filters. Our RF and IF filters come in miniaturized SMD packages down to a size of only $3,8 \times 3,8$ mm. The ultra-small DCC 6 package has a weight of no more than 0,07 g. Furthermore the filters can do without external matching elements and promote compact, low-power circuit design. Steep passband skirts of the filter improve speech quality; low insertion loss means less power consumed and thus longer battery life, or smaller and therefore lighter batteries.

Preface

This data book presents the current product range of Siemens Matsushita Components, with exemplary specification of typical standard types in full detail. Filters which are only listed in the surveys without further specification are marked by the sign #. Detailed information on these types can be obtained from your nearest Siemens Sales Office.

Although the data book is intended to give comprehensive information about our product range, its focus is necessarily on standard products. Our special strength are custom filter solutions. With a special design software, devised in-house, and advanced CAD methods SAW filters can be rapidly designed and modified to customer specifications.

If you have any questions, if you need information on special applications not covered in this data book, or applications engineering support, do not hesitate to contact your nearest Siemens Sales Office, Passive Components and Electron Tubes Group; an address list is contained in the last chapter.

	Page
Selector guide	<u>9</u>
Alphanumeric index of types	<u>22</u>
General technical information	<u>27</u>
1 Introduction	<u>27</u>
1.1 Construction	<u>27</u>
2 Operating principles of TV IF filters	<u>27</u>
2.1 Fundamentals	<u>27</u>
2.2 Phase velocity of surface acoustic waves	<u>28</u>
2.3 Chip size	<u>28</u>
2.4 Filter design	<u>28</u>
3 Characteristics	<u>29</u>
3.1 Feedthrough signals	<u>29</u>
3.2 Triple-transit echo (TTE)	<u>29</u>
3.3 Reflections (spurious signals)	<u>29</u>
3.4 Pulse response	<u>29</u>
3.5 Frequency response	<u>30</u>
3.6 Group delay of TV IF filters	<u>30</u>
3.7 Filter impedances	<u>30</u>
3.8 Temperature coefficient of frequency	<u>33</u>
4 Testing	<u>33</u>
4.1 Final measurements	<u>33</u>
4.2 Measurement results in the frequency range (e.g. TV IF filter for B/G standard)	<u>33</u>
4.3 Minimum, maximum and typical values	<u>34</u>
4.4 Pulse response (time-domain measurement)	<u>34</u>
4.4.1 Test set-up for TV IF filters	<u>35</u>
4.4.2 Method of computation	<u>35</u>
4.5 Test circuits	<u>35</u>
4.6 TV test signals	<u>37</u>
5 Application notes for TV IF SAW filters	<u>39</u>
5.1 Other operating conditions	<u>39</u>
5.2 Matching and driver stage	<u>39</u>
5.3 Switchable video/intercarrier SAW filters for multistandard applications	<u>39</u>
5.4 Switchable audio SAW filters for multistandard applications	<u>40</u>
6 Application notes for resonators and resonator filters	<u>41</u>
6.1 Typical oscillation circuits	<u>41</u>
6.1.1 Oscillators using a one-port resonator	<u>41</u>
6.1.2 Oscillators using a two-port resonator	<u>42</u>
6.2 Application for a wireless remote control system at 433,92 MHz	<u>43</u>
7 Date codes, packing units	<u>45</u>
7.1 Date codes	<u>45</u>
7.2 Packing units (pcs)	<u>45</u>

Contents

8	Quality	46
8.1	Delivery quality	46
8.2	Certification	46
8.3	Qualification	46
8.4	Classification of defects	46
8.5	Incoming inspection	46
8.6	Quality data	46
IF filters for intercarrier applications		47
IF filters for quasi/split sound applications		115
IF filters for video applications		181
IF filters for audio applications		217
Satellite filters		247
Vestigial sideband filters		273
Spectrum-shaping filters		293
Bandpass filters		303
Clock recovery filters		325
Resonators		333
Symbols and terms		347
Standards		349
Subject index		350

Selector Guide

IF filters for intercarrier applications



Picture carrier MHz	Standard	Package	Type	Remarks	Page
33,90	L	SIP 5 K	K 2962 M	2 Nyquist slopes (L/L')	90
36,88	B	SIP 5 K	B 1952 M		49
38,00	D/K	SIP 5 K	D 1952 M		52
	D/K, B/G	SIP 5 K	K 2953 M		55
	D/K, B/G	SIP 5 K	K 2954 M		47
	D/K, B/G	SIP 5 K	K 2958 M		58
	M/N	DIP 10 K	K 6265 K	Internally switchable	61
	D/K, B/G	DIP 10 K	K 6265 K	Internally switchable	61
38,90	D/K	SIP 5 K	D 1990 M		47
	B/G	SIP 5 K	G 1872 M		47
	B/G	SIP 5 K	G 1875 M		66
	B/G	SIP 5 K	G 1960 M	For CENELEC	47
	B/G	SIP 5 K	G 1961 M	For CENELEC	47
	B/G	SIP 5 K	G 1962 M	For CENELEC	69
	B/G	SIP 5 K	G 1963 M	For CENELEC	47
	B/G	SIP 5 K	G 1965 M	For CENELEC	72
	B/G	SIP 5 K	G 1966 M	For CENELEC	75
	B/G	SIP 5 K	G 1967 M	For CENELEC	47
	B/G	SIP 5 K	G 1968 M	For CENELEC	78
	B/G	SIP 5 K	G 1980 M	For CENELEC	47
	B/G NICAM	SIP 5 K	G 1984 M	For CENELEC	47
	I	SIP 5 K	J 1952 M	For CENELEC	81
	I	SIP 5 K	J 1955 M		47
	I NICAM	SIP 5 K	J 1980 M		84
	B/G, D/K	SIP 5 K	K 2951 M		47
	B/G, D/K	SIP 5 K	K 2955 M		87
	B/G, D/K	SIP 5 K	K 2960 M		47
	B/G, D/K	SIP 5 K	K 2962 M	2 Nyquist slopes (L/L')	90
	B/G	DIP 10 K	K 6255 K	Internally switchable For CENELEC	93
	D/K	DIP 10 K	K 6255 K	Internally switchable	93
B/G	DIP 10 K	K 6256 K	Internally switchable	98	
B/G	DIP 10 K	K 6259 K	Internally switchable Also for video appl.	47	
M/N	DIP 10 K	K 6259 K	Internally switchable	47	

Selector Guide

Picture carrier MHz	Standard	Package	Type	Remarks	Page
IF filters for intercarrier applications (continued)					
38,90	B/G	DIP 10 K	K 6260 K	Internally switchable Also for video appl.	47
	M/N	DIP 10 K	K 6262 K	Internally switchable Also for video appl.	47
	M/N	SIP 5 K	M 1956 M		47
39,50	I	SIP 5 K	J 1951 M	For CENELEC	103
	I	SIP 5 K	J 1953 M		48
45,75	M/N	SIP 5 K	M 1859 M	For FCC EIA	106
	M/N	SIP 5 K	M 1861 M		48
	M/N	SIP 5 K	M 1958 M		48
	M/N	SIP 5 K	M 1962 M		109
	M/N	SIP 5 K	M 1963 M		48
	M/N	SIP 5 K	M 1966 M		48
58,75	M	SIP 5 K	N 1951 M		112

IF filters for quasi/split sound applications



Picture carrier MHz	Standard	Package	Type	Remarks	Page
33,90	L	DIP 10 K	K 3261 K		116
36,88	B	DIP 10 K	B 3250 K		115
38,00	D/K	DIP 10 K	D 3650 K		115
	D/K	DIP 10 K	K 3264 K		120
38,90	B/G NICAM	DIP 10 K	G 3254 K	For CENELEC	115
	B/G NICAM	DIP 10 K	G 3255 K		115
	B/G NICAM	DIP 10 K	G 3258 K	For CENELEC	124
	B/G NICAM	DIP 10 K	G 3264 K	For CENELEC	128
	B/G NICAM	DIP 10 K	G 3270 K	For twin PLL ICs	115
	B/G NICAM	DIP 10 K	G 3354 K	For CENELEC	115
	B/G NICAM	DIP 10 K	G 3355 K	For CENELEC	132
	B/G NICAM	DIP 10 K	G 3356 K	For CENELEC	115
	B/G NICAM	DIP 10 K	G 3357 K		115

Picture carrier MHz	Standard	Package	Type	Remarks	Page
IF filters for quasi/split sound applications (continued)					
38,90	B/G NICAM	DIP 10 K	G 3652 K		115
	I NICAM	DIP 10 K	J 3251 K		136
	I NICAM	DIP 10 K	J 3351 K		140
	I NICAM	DIP 10 K	J 3652 K		115
	L	DIP 10 K	K 3252 K		115
	B/G, D/K, I	DIP 10 K	K 3258 K		144
	B/G	DIP 10 K	K 3261 K		116
	B/G, D/K	DIP 10 K	K 3350 K	For CENELEC	148
39,50	I NICAM	DIP 10 K	J 3252 K		152
	I NICAM	DIP 10 K	J 3352 K	For CENELEC	156
45,75	M/N	DIP 10 K	M 3251 K		115
	M/N	DIP 10 K	M 3271 K	For twin PLL ICs	160
	M/N	DIP 10 K	M 3352 K		115
	M/N	DIP 10 K	M 3353 K		115
	M/N	DIP 10 K	M 3354 K	For FCC	164
	M/N	DIP 10 K	M 3355 K		115
	M/N	SIP 5 K	M 3561 M		168
	M/N	DIP 10 K	M 3654 K	For FCC	172
58,75	M	SIP 5 K	N 3561 M		177

IF filters for video applications



Picture carrier MHz	Standard	Package	Type	Remarks	Page
33,40	L	SIP 5 K	G 3957 M	2 Nyquist slopes (L/L') For CENELEC	182
	L	DIP 10 K	K 6260 K	Internally switchable Also for intercarrier appl.	181
33,90	L	SIP 5 K	K 3953 M	2 Nyquist slopes (L/L') For CENELEC	185
	L	DIP 10 K	K 6256 K	Internally switchable Also for intercarrier appl.	181

Selector Guide

Picture carrier MHz	Standard	Package	Type	Remarks	Page
IF filters for video applications (continued)					
33,90	L	DIP 10 K	K 6257 K	Internally switchable 2 Nyquist slopes (L/L') For CENELEC	188
	L	DIP 10 K	K 6263 K	Internally switchable	181
38,00	B/G, D/K	SIP 5 K	K 3955 M	For CENELEC	193
	B/G, D/K	DIP 10 K	K 6266 K	Internally switchable For CENELEC	196
	M/N	DIP 10 K	K 6266 K	Internally switchable	196
38,90	B/G	SIP 5 K	G 3956 M	For CENELEC	201
	B/G, L	SIP 5 K	G 3957 M	2 Nyquist slopes (L/L') For CENELEC	182
	B/G	SIP 5 K	G 3962 M	For CENELEC	181
	B/G	SIP 5 K	G 3963 M	For CENELEC	181
	B/G	SIP 5 K	G 3964 M	For CENELEC	181
	B/G	SIP 5 K	G 3965 M	For CENELEC	204
	B/G	SIP 5 K	G 3967 M	For CENELEC	181
	B/G, I, D/K, L	SIP 5 K	K 3953 M	For CENELEC	185
	D/K, I, L	DIP 10 K	K 6256 K	Internally switchable Also for intercarrier appl.	181
	B/G	DIP 10 K	K 6257 K	2 Nyquist slopes (L/L') Internally switchable For CENELEC	188
	D/K, I, L	DIP 10 K	K 6257 K	Internally switchable	188
	L	DIP 10 K	K 6260 K	Internally switchable Also for intercarrier appl.	181
	B/G	DIP 10 K	K 6262 K	Internally switchable Also for intercarrier appl.	181
	B/G, L	DIP 10 K	K 6263 K	Internally switchable	181
	M/N	DIP 10 K	K 6263 K	Internally switchable	181
M/N	SIP 5 K	M 3960 M		181	
39,50	I	SIP 5 K	J 3950 M	For CENELEC	207
45,75	M/N	SIP 5 K	M 3951 M	For FCC	210
58,75	M	SIP 5 K	N 3954 M		213
	M	SIP 5 K	N 3958 M		181

IF filters for audio applications



Sound carrier MHz	Standard	Package	Type	Remarks	Page
31,50 ... 32,50	D/K, I, B/G	SIP 5 K	K 9455 M	2 channels	219
31,50 ... 33,50	D/K, I, B/G, M/N	SIP 5 K	K 9252 M		217
	D/K, I, B/G, M/N	SIP 5 K	K 9352 M		217
32,40	L	SIP 5 K	L 9360 M		217
	L	SIP 5 K	L 9362 M		223
	L	SIP 5 K	L 9453 M	2 channels	217
	L NICAM	SIP 5 K	L 9454 M	2 channels	225
	L NICAM	SIP 5 K	L 9455 M	2 channels	217
	L	SIP 5 K	L 9456 M	2 channels	228
	L	SIP 5 K	L 9460 M	2 channels	217
32,40 ... 32,90	D/K, L, I	SIP 5 K	K 9460 M	2 channels	217
	D/K, L, I NICAM	SIP 5 K	K 9463 M	2 channels	217
32,40 ... 33,40	D/K, I, B/G	SIP 5 K	K 9260 M		231
	D/K, L, I, B/G	SIP 5 K	K 9350 M		217
	D/K, L, I, B/G	SIP 5 K	K 9453 M	2 channels	233
	D/K, L, I, B/G	SIP 5 K	K 9462 M	2 channels	217
32,40 ... 34,40	D/K, I, B/G, M/N	SIP 5 K	K 9253 M		217
32,90	I NICAM	DIP 10 K	K 4350 K	2 channels	217
	I NICAM	SIP 5 K	K 9353 M		217
33,40	B/G NICAM	SIP 5 K	G 9251 M		217
	B/G, L NICAM	SIP 5 K	G 9353 M		237
	B/G, L NICAM	DIP 10 K	K 4350 K	2 channels	217
	B/G, L NICAM	SIP 5 K	K 9460 M	2 channels	217
	B/G, L NICAM	SIP 5 K	K 9463 M	2 channels	217
33,50	I NICAM	SIP 5 K	J 9250 M		217
	M/N	SIP 5 K	K 9455 M	2 channels	219
34,40	M/N	SIP 5 K	K 9461 M	2 channels	217
	M/N	SIP 5 K	K 9462 M	2 channels	217
39,20	L	SIP 5 K	L 9361 M		217
39,90	L NICAM	SIP 5 K	L 9455 M	2 channels	218
	L	SIP 5 K	L 9460 M	2 channels	218
40,40	L	SIP 5 K	L 9353 M		218

Selector Guide

Sound carrier MHz	Standard	Package	Type	Remarks	Page
IF filters for audio applications (continued)					
40,40	L NICAM	SIP 5 K	L 9354 M		218
	L	SIP 5 K	L 9453 M	2 channels	218
	L NICAM	SIP 5 K	L 9454 M	2 channels	225
	L	SIP 5 K	L 9456 M	2 channels	228
	L	SIP 5 K	K 9453 M	2 channels	233
	L	SIP 5 K	K 9461 M	2 channels	218
41,00	L	SIP 5 K	L 9461 M	2 channels	218
41,25	M/N	SIP 5 K	M 9260 M		240
	M/N	SIP 5 K	M 9352 M		242
54,25	M	SIP 5 K	N 9260 M		218
	M	SIP 5 K	N 9350 M		245

Satellite filters



Center frequency MHz	3 dB bandwidth MHz	Package	Type	Remarks	Page
402,78	27,0 + 31,0	TO 39	B 609		248
403,18	26,9 + 32,1	TO 39	B 629	Integr. shunt resistors	247
	31,3	TO 39	B 682		253
479,50	27,0 + 18,0	TO 39	B 611		256
	27,0 + 32,0	TO 39	B 615		247
	27,0 + 36,0	TO 39	B 619		247
	21,5 + 27,0	TO 39	B 621		247
	15,0 + 27,0	TO 39	B 625		247
480,00	33,5 + 36,1	TO 39	B 635	Integr. shunt resistors	261
	15,7	TO 39	B 662	Integr. shunt resistors	247
	32,0	TO 39	B 674		247
	22,5	TO 39	B 680		247
	36,2	TO 39	B 686		247
	26,6	TO 39	B 692	Integr. shunt resistors	266
	17,6	TO 39	B 694	Integr. shunt resistors	269
26,6	TO 39	B 696		247	

Vestigial sideband filters



Picture carrier MHz	Standard	Package	Type	Remarks	Page
32,70	L	DIP 24-06	B 540		273
38,00	D/K	DIP 24-06	B 542	With sound suppression	273
	D/K	SIP 6 M	B 587	With sound suppression	273
38,90	B/G	DIP 24-03	B 522	With sound suppression	273
	B/G	DIP 24-03	B 523		274
	B/G	DIP 16	B 530	With sound suppression	277
	B/G	DIP 16	B 531		273
	B/G	DIP 24-06	B 534	With sound suppression	273
	B/G	DIP 24-06	B 537		280
	I	DIP 24-06	B 541		273
	D/K	DIP 24-06	B 543		273
	I	DIP 24-06	B 576	NICAM	273
	B/G	SIP 6 M	B 585	With sound suppression	283
	I	SIP 6 M	B 586	With sound suppression	273
45,75	B/G	SIP 6 M	B 588	With sound suppression	273
	B/G	SIP 5 K	G 4960 M	With sound suppression	286
	D/K	SIP 5 K	K 4960 M	With sound suppression	273
	M/N	DIP 24-06	B 545		289
M/N	SIP 5 K	M 4950 M	With sound suppression	273	

Selector Guide

Spectrum-shaping filters



Center frequency MHz	Nyquist frequency MHz	Package	Type	Page
70,00	11,95	DIP 16	B 2540	293
	12,10	DIP 16	B 2559	293
	12,30	DIP 16	B 2565	293
	7,755	DIP 16	B 2569	294
	7,755	DIP 16	B 2570	297
	13,52	DIP 24-06	B 2573	293
122,50	13,52	DIP 16	B 2578	293
157,50	13,52	DIP 16	B 2579	300
140,00	13,82	DIP 16	B 2580	293

Bandpass filters



Center frequency MHz	Standard	Package	Type	Page
36,00	DAB	SIP 6 M	B 589	303
36,20	DCR	SIP 5 K	X 6967 M	303
38,912	DAB	SIP 6 M	B 512	304
44,00	Interactive TV	SIP 5 K	X 6959 M	307
45,00	GSM	DIP 24-03	B 1507	303
60,00	DSS	SIP 5 K	X 6956 M	310

Center frequency MHz	Standard	Package	Type	Page
Bandpass filters (continued)				
70,00	—	DIP 16	B 504	313
	—	DIP 16	B 519	303
	—	DIP 16	B 590	303
118,00	—	DIP 16	B 521	316
140,00	—	DIP 16	B 1529	303
287,35	—	DIP 16	B 1505	319
439,85	—	TO 8	B 558	322

Clock recovery filters



Center frequency MHz	Insertion attenuation (max) dB	Package	Type	Page
51,840	29,5	DIP 16	B 5545	325
139,264	21,0	TO 8	B 5505	325
155,520	18,5	TO 8	B 5533	326
	19,5	DIP 16	B 5549	325
167,118	17,0	TO 8	B 5506	325
181,043	17,5	TO 8	B 5504	325
622,080	19,5	TO 39	B 5531	329
	20,5	TO 8	B 5547	325
659,157	18,0	TO 8	B 5513	325
2488,320	21,0	TO 39	B 5534	325







Selector Guide

Resonators



Center frequency MHz	Insertion attenuation dB	Package	Type	Page
-------------------------	--------------------------------	---------	------	------

1-port resonators

314,50	2,0	TO 39	R 660	333
	1,5	QCC 8 	R 706	333
315,00	2,0	TO 39	R 639	333
	1,5	QCC 8 	R 705	333
417,50	1,4	QCC 8 	R 704	333
418,00	1,8	TO 39	R 643	333
	1,4	QCC 8 	R 703	334
423,22	1,8	TO 39	R 644	333
433,42	1,8	TO 39	R 647	333
	1,6	QCC 8 	R 702	333
433,92	1,7	TO 39	R 641	336
	1,7	QCC 8 	R 701	333

2-port resonators

213,80	9,1	TO 39	R 2637	333
224,50	8,5	TO 39	R 2523	333
304,35	7,3	TO 39	R 2653	333
315,05	5,5	TO 39	R 2622	333
403,55	7,5	TO 39	R 2526	333
407,35	8,6	TO 39	R 2635	333
414,25	7,0	TO 39	R 2620	333
	9,2	QCC 8 	R 2702	338
418,05	8,3	TO 39	R 2630	333
423,22	7,3	TO 39	R 2531	333
433,92	7,8	TO 39	R 2632	340
	9,2	QCC 8 	R 2701	333
849,25	11,0	TO 39	R 2533	333

Center frequency MHz	Insertion attenuation dB	Package	Type	Page
-------------------------	--------------------------------	---------	------	------

Frontend filters for remote control

314,00	2,5	TO 39	B 3532	333
315,00	2,5	TO 39	B 3531	333
403,55	2,5	TO 39	B 3533	333
433,92	2,3	TO 39	B 3530	343



Siemens Matsushita Components

Applications with a future

We set your ideas in motion

When it comes to implementing ideas, you couldn't choose a better partner. Our flexibility turns standard products into new designs with all the right features. Whether capacitors and converter filters for wind-driven power plants, ferrite antennas for radio wrist-watches or SAW filters for the new wide-screen TV generation. If you've got the application, we've got the component.



SCS – dependable, fast and competent





Siemens Matsushita Components

Quality without compromises top with TQM

We're not satisfied until you are. So our quality demands are quite tough. And they don't start in production, they span the whole field from development to despatch. To watch over it all we implemented Total Quality Management, a system aimed at continuous improvement – in everything. That includes true-to-schedule delivery and service readiness, ISO 9000 for all plants, modern QA, commitment to the environment in manufacturing, materials and packing plus constant training of employees. All embedded in *top*, the worldwide quality campaign of the Siemens organization.



More about "top with TQM" in this brochure!

SCS – dependable, fast and competent

top

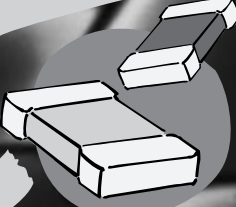

Components

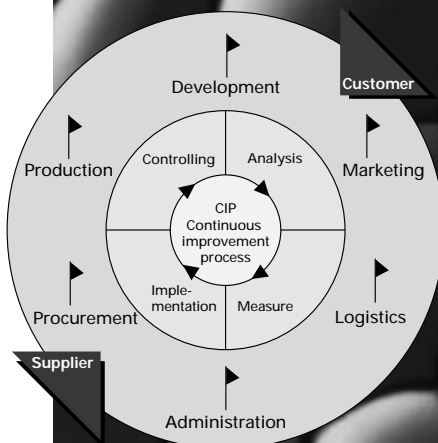

Alphanumeric Index of Types

Type	Page
B 504	313
B 512	304
B 519	304
B 521	316
B 522	273
B 523	274
B 530	277
B 531	273
B 534	273
B 537	280
B 540	273
B 541	273
B 542	273
B 543	273
B 545	289
B 558	322
B 576	273
B 585	283
B 586	273
B 587	273
B 588	273
B 589	303
B 590	303
B 609	248
B 611	256
B 615	247
B 619	247
B 621	247
B 625	247
B 629	247
B 635	261
B 662	247
B 674	247
B 680	247
B 682	253
B 686	247
B 692	266
B 694	269
B 696	247
B 1505	319
B 1507	303

Type	Page
B 1529	303
B 1952 M	49
B 2540	293
B 2559	293
B 2565	293
B 2569	294
B 2570	297
B 2573	293
B 2578	293
B 2579	300
B 2580	293
B 3250 K	115
B 3530	343
B 3531	333
B 3532	333
B 3533	333
B 5504	325
B 5505	325
B 5506	325
B 5513	325
B 5531	329
B 5533	326
B 5534	325
B 5545	325
B 5547	325
B 5549	325
D 1952 M	52
D 1990 M	47
D 3650 K	115
G 1872 M	47
G 1875 M	66
G 1960 M	47
G 1961 M	47
G 1962 M	69
G 1963 M	47
G 1965 M	72
G 1966 M	75
G 1967 M	47
G 1968 M	78
G 1980 M	47
G 1984 M	47

Alphanumeric Index of Types

Type	Page
G 3254 K	115
G 3255 K	115
G 3258 K	124
G 3264 K	128
G 3270 K	115
G 3354 K	115
G 3355 K	132
G 3356 K	115
G 3357 K	115
G 3652 K	115
G 3956 M	201
G 3957 M	182
G 3962 M	181
G 3963 M	181
G 3964 M	181
G 3965 M	204
G 3967 M	181
G 4960 M	286
G 9251 M	217
G 9353 M	237
J 1951 M	103
J 1952 M	81
J 1953 M	48
J 1955 M	47
J 1980 M	84
J 3251 K	136
J 3252 K	152
J 3351 K	140
J 3352 K	156
J 3652 K	115
J 3950 M	207
J 9250 M	217
K 2951 M	47
K 2953 M	55
K 2954 M	47
K 2955 M	87
K 2958 M	58
K 2960 M	47
K 2962 M	90
K 3252 K	115
K 3258 K	144

Type	Page
K 3261 K	116
K 3264 K	120
K 3350 K	148
K 3953 M	185
K 3955 M	193
K 4350 K	217
K 4350 K	217
K 4960 M	273
K 6255 K	93
K 6255 K	98
K 6256 K	181
K 6256 K	181
K 6257 K	188
K 6259 K	47
K 6259 K	47
K 6260 K	181
K 6260 K	181
K 6260 K	47
K 6262 K	181
K 6262 K	47
K 6263 K	181
K 6263 K	181
K 6263 K	181
K 6265 K	61
K 6266 K	196
K 9252 M	217
K 9253 M	217
K 9260 M	231
K 9350 M	217
K 9352 M	217
K 9353 M	217
K 9453 M	233
K 9455 M	219
K 9460 M	217
K 9460 M	217
K 9461 M	217
K 9461 M	218
K 9462 M	217
K 9462 M	217
K 9462 M	217
K 9463 M	217
K 9463 M	217

Alphanumeric Index of Types

Type	Page
L 9353 M	218
L 9354 M	218
L 9360 M	217
L 9361 M	217
L 9362 M	223
L 9453 M	217
L 9453 M	218
L 9454 M	225
L 9455 M	217
L 9455 M	218
L 9456 M	228
L 9460 M	217
L 9460 M	218
L 9461 M	217
L 9461 M	218
M 1859 M	106
M 1861 M	48
M 1956 M	47
M 1958 M	48
M 1962 M	109
M 1963 M	48
M 1966 M	48
M 3251 K	115
M 3271 K	160
M 3352 K	115
M 3353 K	115
M 3354 K	164
M 3355 K	115
M 3561 M	168
M 3654 K	172
M 3951 M	210
M 3960 M	181
M 4950 M	273
M 9260 M	240
M 9352 M	242
N 1951 M	112
N 3561 M	177
N 3954 M	213
N 3958 M	181
N 9260 M	218
N 9350 M	245

Type	Page
R 639	333
R 641	340
R 643	333
R 644	333
R 647	333
R 660	333
R 701	333
R 702	333
R 703	334
R 704	333
R 705	333
R 706	333
R 2523	333
R 2526	333
R 2528	333
R 2531	333
R 2533	333
R 2620	333
R 2622	333
R 2630	333
R 2632	340
R 2635	333
R 2637	333
R 2653	333
R 2701	333
R 2702	338
X 6956 M	310
X 6959 M	307
X 6967 M	303



Siemens Matsushita Components

A whole lot of ring core chokes

Chokes to your choice

You urgently need particular ring core chokes? That's no problem, we have 200,000 pieces in stock and deliver reliably through SCS. Our automated production guarantees



the best of reliability too. It turns out chokes in different versions: flat and upright, with current rated from 0.4 to 16 A. UL and VDE approved, and complying with the latest EMC standards of course.

SCS – dependable, fast and competent

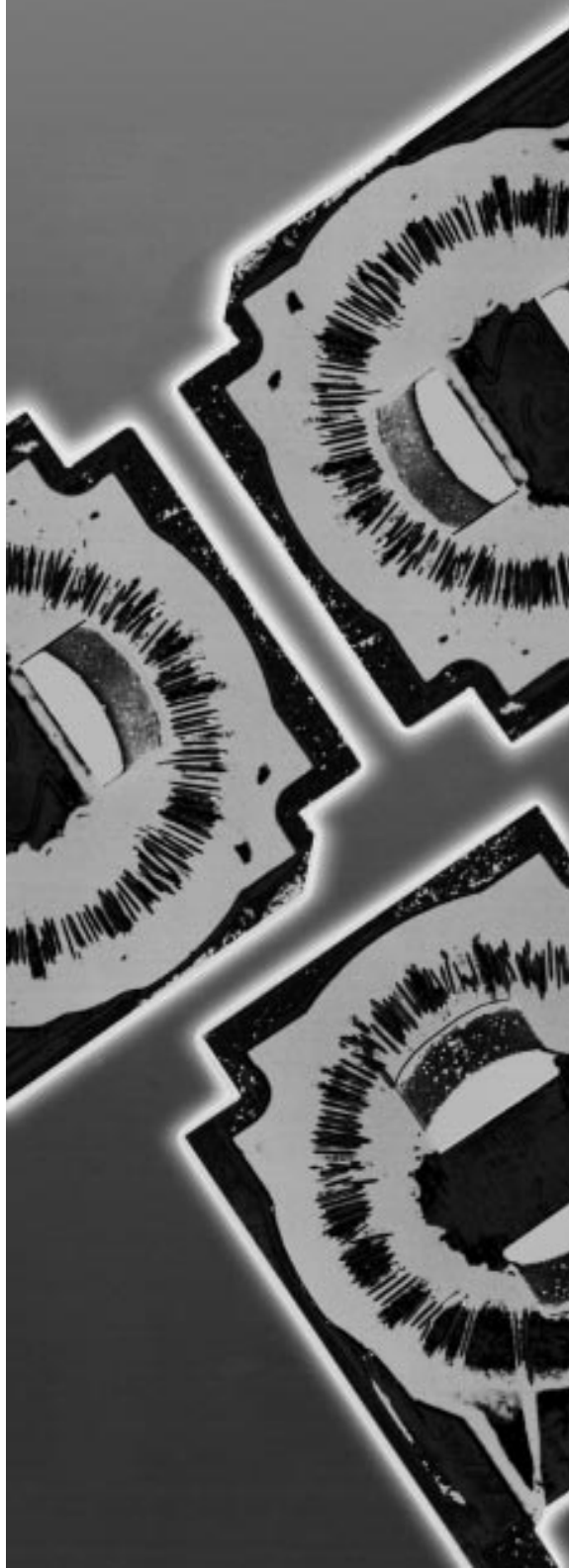



Siemens Matsushita Components

NTC thermistor chips for temperature compensation

Keep cool

No matter what the temperature, that's the promise behind our NTC chips in 0805 and 1206 sizes, available direct from SCS stock. These chips do valuable service in handies, ensuring clear contrast in the display and optimum reception in the crystal oscillator, besides proper charging of the battery. In hybrid and SMT circuits, NTC chips cover a temperature range of -55 °C through +125 °C.



SCS – dependable, fast and competent

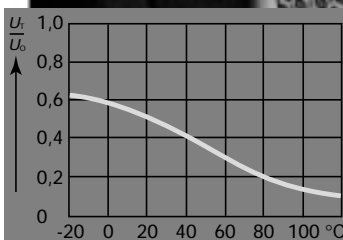

General Technical Information

1 Introduction

Surface acoustic wave filters (SAW filters) are integrated, passive components with bandpass filter characteristics. Their operation is based on the interference of mechanical surface waves. Compared to coil filters, surface acoustic wave filters provide a series of favorable characteristics:

- High reproducibility
- High performance
- Stable characteristics
- No adjustment required
- Amplitude response and phase response can be specified independently of each other
- Close tolerances of data
- Small space requirements (a complete TV IF filter only takes up 0,5 cm²)

The user of a surface acoustic wave filter has a component which fully replaces complex LC combinations and yields superior picture and sound quality.

1.1 Construction

A metal layer (Al) is vapor-deposited onto a single-crystal, piezoelectric substrate. Using a photo-etching technique, the metal is removed to obtain fine, finger-like interspersed electrodes (interdigital transducers), which serve as piezoelectrical input and output transducers. The substrate is then bonded to a metal base and connected to the terminals by means of bonding wires.

An absorber prevents surface waves reflected from the edges of the substrate from causing spurious signals. The SAW filter is encapsulated to protect it from external influences.

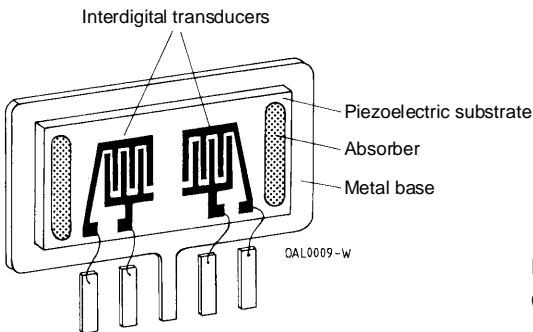

Figure 1
Construction of a SAW TV IF filter

2 Operating principles of TV IF filters

2.1 Fundamentals

When electrical signals are applied to the input transducer, it launches mechanical (“acoustic”) surface waves which, due to reciprocity, in turn produce electrical signals in the output transducer. The transducers act as transmit/receive “antennas” for surface acoustic waves. Widely varying “antenna characteristics” can be achieved as a result of the transducer structure. The center frequency, amplitude response and group delay are determined by the number, length, arrangement and spacing of the transducer fingers (see para. 2.4). Superposing of the “antenna characteristics” of the input and output transducers results in the filter characteristic.

General Technical Information

All TV IF filters included in this book consist of transducers with constant finger widths and spacings. One of the transducers has constant finger lengths (unweighted or unapodized transducer) whereas the other one has varying finger lengths (weighted or apodized transducer). In most cases the first one operates as output transducer and the second one as input transducer.

The transfer function of the unweighted transducer is $\sin(x)/x$ -shaped; its center frequency depends on the spacing of the fingers and its bandwidth on the number of the fingers. The higher the number of the fingers, the smaller is the bandwidth of the transducer. The finger widths range from 27 μm (G 1962 M: IF 38,9 MHz) to 1,2 μm (B 696: IF 480,0 MHz).

The amplitude and group delay of a weighted transducer's transfer function can be set independently of each other. The transfer characteristic of the filter can be closely approximated by multiplying the transfer characteristics of the two transducers.

2.2 Phase velocity of surface acoustic waves

The phase velocity of surface acoustic waves is frequency-independent. Depending on the substrate material and the crystal cut, the phase velocity ranges from 3000 to 4000 m/s.

2.3 Chip size

The required chip size largely depends on the desired filter data. Narrowband performance, steep slopes and high group delay predistortion necessitate transducers with many fingers and, hence, with a long substrate. Filters with two inputs or outputs require broad substrates.

2.4 Filter design

The filter design is based on the specification of the filter and is performed in two steps.

In the first step, the linear design, the center frequency and bandwidth of the filter are used to specify the unweighted transducer as well as the width and number of fingers for the weighted transducer. The finger lengths of this transducer, which determine its transfer function, are found by a linear optimization program (simplex algorithm). In this program, a smooth pass band, a tolerance scheme, continuity conditions, a Nyquist slope, single frequency points (e.g. color carrier) or derivatives of slopes (e.g. at the sound shelf) as well as the value to be optimized (e.g. stop band rejection or the amplitude of the color carrier) can be specified. If a solution is possible with respect to the given filter length, the algorithm finds the unique solution for which the specified conditions are satisfied exactly. If no solution is possible, the specifications must be relaxed or the filter length must be extended.

In the filter just designed, none of the secondary order effects of a SAW filter have been taken into account, such as diffraction of the waves due to small radiating apertures (e.g. 0,1 to 15 wavelengths for G 1962 M), the influence of the circuitry (frequency-dependent voltage division on the load resistance), the distribution of electrical charges on the transducer fingers or reflection of the waves at the edges of the fingers.

In the second step of design, these secondary order effects are calculated with the aid of a simulation program and their influence on the transfer function will be corrected by a predistortion in the weighted transducer. This modification of the transducer is performed by a least square optimization program. After compensation for the secondary order effects, the design of the SAW filter is complete, a mask can be made and the filter produced.

3 Characteristics

Surface acoustic wave TV IF filters are based on the interference of mechanical surface waves, i.e. on delay effects and not on resonance. This is the reason why some characteristics differ from those of coil filters.

3.1 Feedthrough signals

Surface acoustic wave TV IF filters have a basic delay of approx. 1 μs . If unfavorable circuitry has been selected, it is quite possible for direct electrical feedthrough to be exhibited as a preecho. It is therefore advisable to terminate the filter asymmetrically at its input and symmetrically at its output. Moreover, the input and output circuitry should be appropriately spaced; long filter leads should also be avoided.

3.2 Triple-transit echo (TTE)

The triple-transit echo is an interfering signal typical of surface acoustic wave TV IF filters: the surface acoustic wave from the input transducer is reflected by the output transducer, returns to the input transducer where it is again reflected, and appears as an echo signal at the output with 3-times the basic delay.

In principle, this signal is always present; however its level is not a filter constant, but is a function of the insertion loss, i.e. of internal filter attenuation and the source and load impedances. In practice, it is important to suppress the triple-transit echo at the input by low source impedance. The triple-transit echo virtually does not occur in filters designed for high-impedance loads (e.g. G1962M); if the filter is connected as specified, the TTE signal is prevented by an internal reflection compensation in the output transducer. In filters designed for low-impedance loads the TTE is suppressed by approximately double the insertion attenuation of the filter.

3.3 Reflections (spurious signals)

A transducer emits surface acoustic waves in both directions. The waves impinging on the substrate edge and reflected there can appear as echo signals. For this reason, the substrate edges are provided with an attenuator which absorbs the surface acoustic waves. In this way, reflections are reduced to a non-critical level.

3.4 Pulse response

The interfering effects mentioned above – feedthrough, triple-transit echo and reflections – are echo signals and are therefore in the time domain. During the design stage, such interfering effects will be calculated and kept as small as possible. In order to guarantee excellent picture and sound quality it is therefore important to record the time-domain performance, the so-called pulse response (see 4.3) in production. In the frequency domain such echos cause a ripple in the pass band of the filter. The ripple frequency is proportional to the distance in time and the ripple amplitude is proportional to the amplitude of the echo signal.

General Technical Information

3.5 Frequency response

The frequency response complies with the relevant standard or with customer-specific requirements. It can be adjusted to the user's applications, if permitted by the technology, state of the art and chip size. On account of the finite length of the transducers, which corresponds to a time-limited pulse response, the steepness of slope is limited.

Since SAW filters consist of periodic finger structures, the interdigital transducers, these are also active at the harmonics of the basic frequency. However, not all harmonic waves are excited. With G 1962 M, for example, every fourth harmonic wave is excited.

3.6 Group delay of TV IF filters

The average group delay complies with the relevant standard or customer-specific requirements and is characterized in the data sheets as follows:

e.g. standard B/G (G 1968 M)

Group delay τ

Reference frequency	38,90 MHz	
Maximum sag	36,90 MHz	– 90 ns
Color carrier	34,47 MHz	165 ns

The typical value of the group delay ripple in the pass band is specified for filters with constant group delay.

The group delay ripple depends on the echo signals, being proportional to amplitude and delay of the echo signals. Despite small amplitude and low signal power, distant echo signals may therefore lead to a considerable high-frequency group delay ripple without causing any critical phase shifts. Thus a sinusoidal group delay ripple of 100 ns peak-to-peak and a period of 800 kHz ($\cong 1,25 \mu\text{s}$ echo delay) results in a phase shift of only $\pm 2^\circ$. Several non-critical reflections e.g. of 50 dB, in contrast, may add up to a conspicuous group delay ripple of 50 ns. For this reason, specification of the group delay ripple for SAW filters with system-related, distant echo signals is only sensible when a frequency aperture is given. An aperture of 50 kHz is assumed for the group delay diagrams included in the data sheets.

3.7 Filter impedances

The input and output impedances of a SAW filter comprise the transducer's basic capacitance, the electrical image of the acoustic wave emission and the influence of the reflection of the waves from other transducers, which cause a ripple.

The transducer impedances are therefore strongly frequency-dependent and, in conjunction with the terminating impedances, can influence the frequency response of the filter. Heavy capacitive loading at the output can, for example, produce slopes in the transfer function. Therefore, the specified terminating impedance for which the filter was designed should be used.

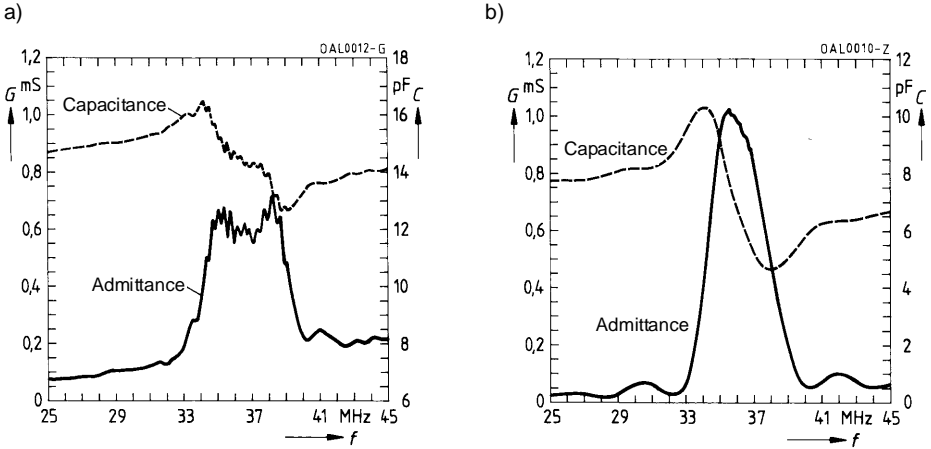

Figure 2

a) Input transducer admittance of G 1968 M
Output connected to 2 k Ω in parallel to 3 pF

b) Output transducer admittance of G 1968 M
Input connected to 50 Ω

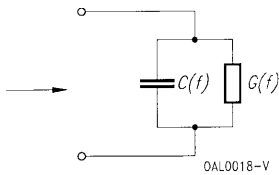

Figure 3

Equivalent circuit diagram
Filter output
terminated with 2 k Ω
in parallel to 3 pF

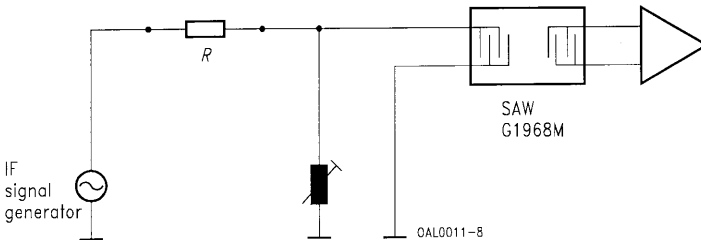

Figure 4

Schematic test circuit for TV IF filters

Adjustment of resonant circuit (inductor and filter input capacitance) to picture carrier (38,9 MHz). Resistor R is chosen such that the inductor is attenuated by 1 k Ω , 300 Ω , 100 Ω or 30 Ω .

For information on 2T and step signal refer to para. [4.6](#).

General Technical Information

The effects of different drive impedances (30 Ω to 1 kΩ) on the pulse response are shown below, using G 1968 M as an example.

x-axis:
0.5 μs/Div.

1 kΩ

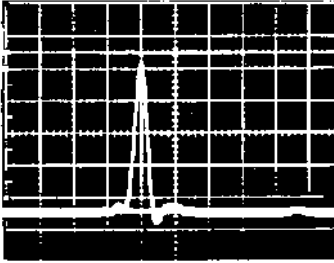
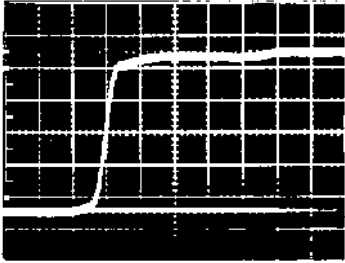

300 Ω

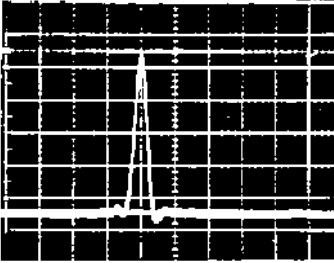
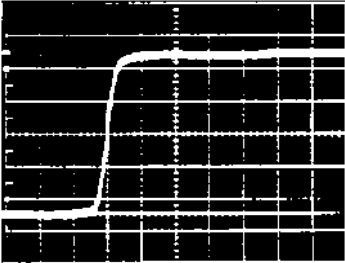

100 Ω

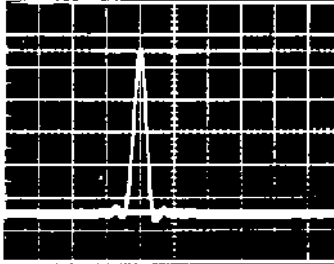
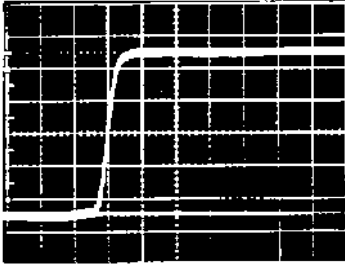

30 Ω

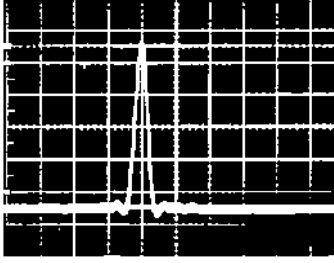
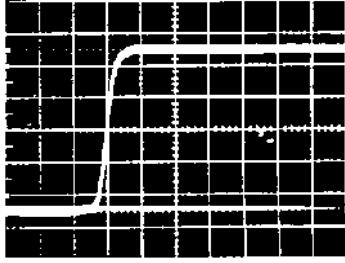

Figure 5
2T/step signal behavior

The response shown in Figure 5 is typical of many TV IF SAW filters. If the drive impedance is too high, 2T signals and rising edges become fuzzy, and the triple-transit also becomes noticeable (2,3 μ s after the main pulse). From about 100 Ω the picture is perfect; a further reduction in drive impedance yields no improvement. We therefore recommend selecting drive impedances for TV IF filters as described in section 5.2. When driver stages with considerably different impedances are used (e.g. > 200 Ω), it should be checked which filter types are capable of producing the desired results.

3.8 Temperature coefficient of frequency

The temperature coefficient of frequency of a SAW filter is governed by the substrate material or crystal cut. With the lithium niobate Y/Z cut (standard cut), it is -94 ppm/K, and with the 128 Y/X cut (rotated cut) it is -72 ppm/K. The temperature coefficient causes the filter curve to shift towards lower frequencies as the temperature rises. For operation within a TV set, therefore, a frequency variation of the order of -50 kHz will be produced, compared to the frequency at room temperature. With the lithium tantalate 36 Y/X cut (rotated cut) it is -30 ppm/K and with the X/112 Y it is -18 ppm/K.

4 Testing

4.1 Final measurements

SAW filters are subject to a 100 % final test in specially developed automatic measuring instruments. The RF section of this automatic measuring instrument consists of a network analyzer and a test jig. A computer controls all the data of the filters and determines a set of measured values in the frequency domain and in the time domain that guarantees characteristics which have not been measured directly, as, for example, the 2T response. Thus, minimum measuring time and maximum selectivity are favorably combined in this final measuring process.

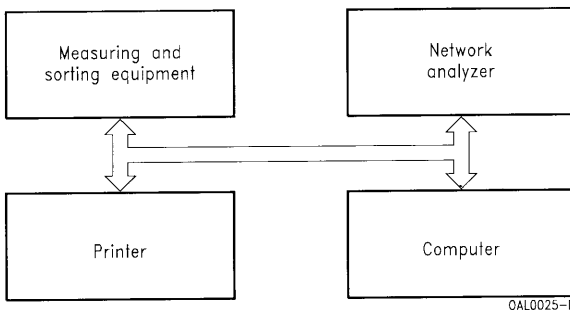

Figure 6
Computer-controlled test station

4.2 Measurement results in the frequency range (e.g. TV IF filter for B/G standard)

Insertion attenuation at 37,40 MHz

The attenuation value of the filter at 37,40 MHz is determined in the test circuit (see Figure 10). For this purpose a capacitive short circuit is placed between the outer connections (pins 1 and 5) and the inner connections (pins 2 and 4) instead of the filter; the insertion attenuation of the filter is given relative of the transmitted signal.

General Technical Information

Relative attenuation

The attenuation values α_{rel} given in the data sheets refer to the level at e.g. 37,40 MHz (for B/G standard filters). In the lower/upper sidelobe region, the minimum value of the attenuation is given in each case.

Picture carrier		38,90 MHz	Adjacent stereo sound carrier	40,15 MHz
Color carrier		34,47 MHz	Adjacent sound carrier	VHF 40,40 MHz
Sound carrier		33,40 MHz		UHF 41,40 MHz
Adjacent picture carrier	UHF	30,90 MHz	Lower sidelobe	25,00 ... 31,90 MHz
	VHF	31,90 MHz	Upper sidelobe	40,40 ... 45,00 MHz
FTZ trap		32,40 MHz		

4.3 Minimum, maximum and typical values

On account of unavoidable variations in the materials and the process, all measured values show certain scatters that often follow a standard distribution. The minimum and maximum values given in the data book correspond to the measurement limits of the final measurements allowing for uncertainties and which themselves take into account any scatter.

The typical values specified correspond to the 50%-points in the cumulative distribution of the corresponding measurement values. For normal (symmetrical) distributions of measurement values (e.g. in the case of picture carriers, color carriers, sound carriers), the typical value equals the arithmetic mean. In the case of asymmetrically distributed values (e.g. for traps, upper/lower sidelobe), the typical value is generally somewhat smaller than the arithmetic mean.

The values given in the data book have each been determined from a large number of filters. These mean values may, however, also be subject to certain variations.

4.4 Pulse response (time-domain measurement)

In order to measure the pulse response, a burst is applied to the filter input and the output voltage is assessed according to the following diagram. Figure 7 shows the schematic envelope curve of the RF output voltage (oscilloscope trace).

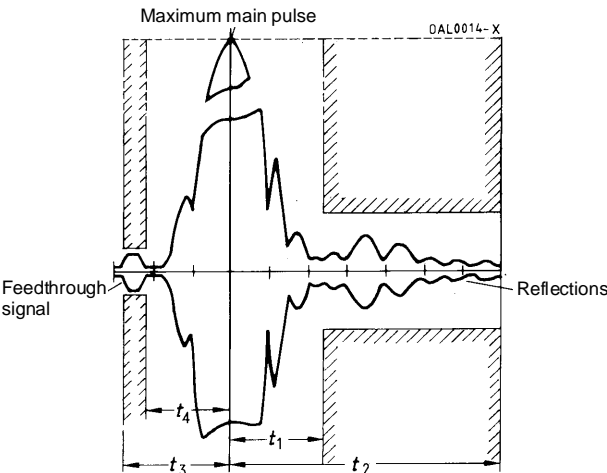

For example

$$t_1 = 1,2 \mu\text{s}$$

$$t_2 = 6,0 \mu\text{s}$$

$$t_3 = 1,4 \mu\text{s}$$

$$t_4 = 1,1 \mu\text{s}$$

Reflections $\leq -42 \text{ dB}$

Feedthrough

signals $\leq -50 \text{ dB}$

Figure 7

Envelope curve of the RF output voltage

4.4.1 Test set-up for TV IF filters

The circuit shown in Figure 8 allows the pulse response to be measured. In order to obtain the required dynamic range of 70 dB ... 80 dB, the measuring instrument consists of two electronic mixers. Figure 9 shows the burst used: the half pulse width $t_{hw} = 250$ ns is matched to the filter bandwidth. The exact slope of the pulse is non-critical. The carrier frequency of the pulse is the frequency for which the rated insertion attenuation is specified.

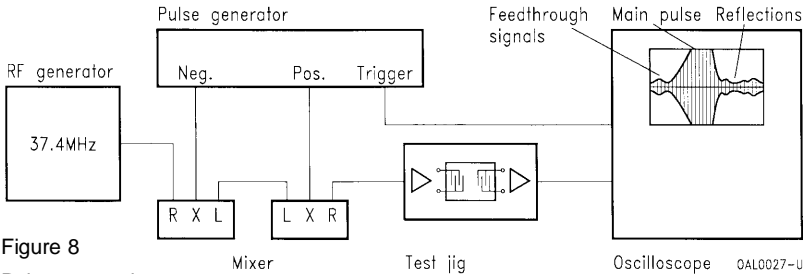
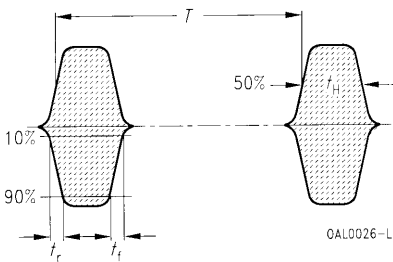

Figure 8
Pulse measuring set-up



$t_{hw} = 250$ ns
 $t_r = t_f = 50$ ns
 $T = 7$ μ s
 $f_r =$ Carrier frequency
 equal to the
 reference frequency

Figure 9
Burst pulse

4.4.2 Method of computation

In final measurements, a computation process equivalent to one of the methods described above is used to evaluate the transfer function of the filter (measurement values in the frequency range), which is measured by a vectorial network analyzer. For this the complex transfer function is multiplied by the spectrum of the burst and transformed into the time domain by means of a Fourier transform. The amplitude of the transformed signal is evaluated.

4.5 Test circuits

For the automatic measuring instrument mentioned in 4.1, special test circuits were designed for TV IF filters; all data sheet information relates to these circuits. Different circuits are used for SIP-5 and DIP-10 filters (Figure 10 and 11). In both cases, wideband drivers with an output impedance of 50 Ω were used. Filters of all standards can thus be driven without switching or adjustment. Post-amplifiers provide symmetrical filter termination. The test jigs have a common-mode rejection of ≥ 30 dB at up to 80 MHz; the frequency response is negligible, and the gain is set to 26 dB. The test jigs are thus fully interchangeable. For all other types of SAW filter, test jigs are used which ensure 50 Ω drive and load impedance to the SAW filter or the combination SAW filter and matching network respectively.

General Technical Information

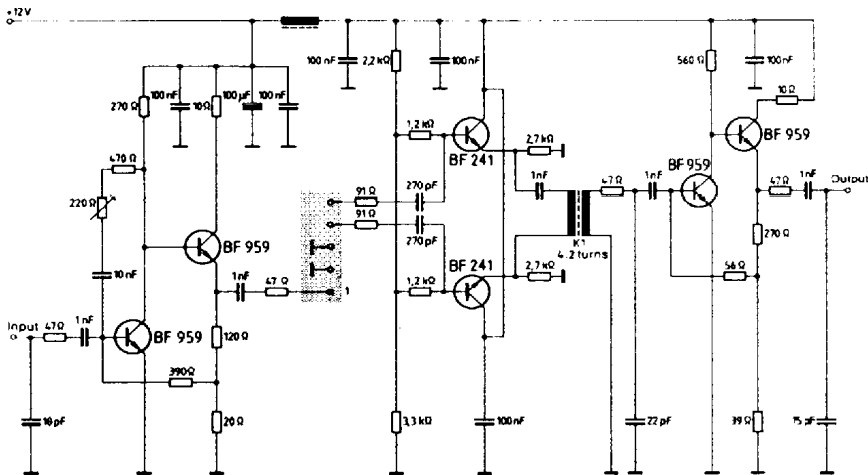

Figure 10

Test circuit for SIP-5 filter

Input impedance of the symmetrical post-amplifier: 2 kΩ in parallel with 3 pF

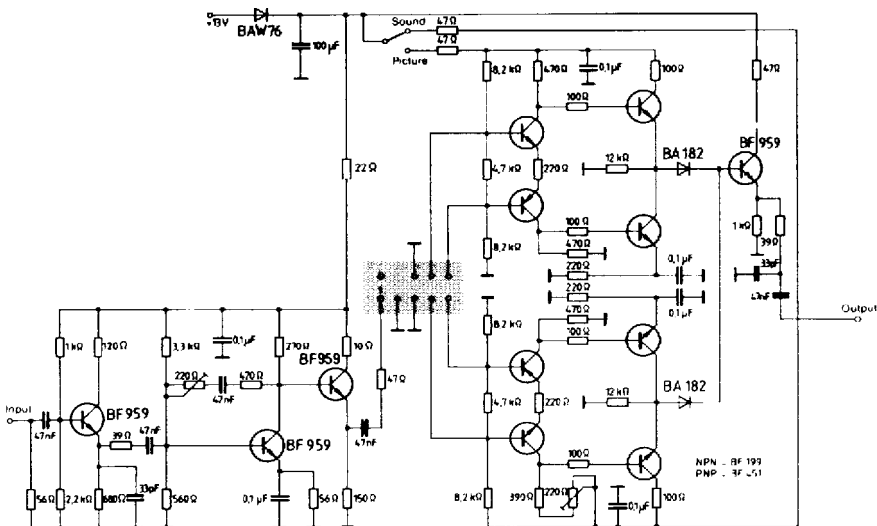

Figure 11

Test circuit for DIP-10 filter

Input impedance of the symmetrical post-amplifier: 2 kΩ in parallel with 5 pF

4.6 TV test signals

To check the transmission quality of a TV system, there is a series of special test signals, which in part are continually transmitted by the transmitter in certain lines external to the actual picture. These test signals enable detailed and realistic conclusions to be drawn without special measuring equipment.

To assess a SAW filter, two signals are of particular interest: the 2T signal (also $\cos^2 2T$ or $\sin^2 2T$ pulse) and the step signal.

On the screen the **2T signal** corresponds to a vertical white raster line. It approximates a \sin^2 -shaped pulse with a duration (= half-value width) of $2T = 1/f_c$, where f_c is the upper rated cutoff frequency of the video band. For the B/G standard, $f_c = 5$ MHz, thus resulting in $2T = 200$ ns. Such a signal has a frequency spectrum lying mainly below f_c . Clearly stated, the 2T pulse is the shortest signal that can still be processed by the system without distortion.

The oscilloscope picture of the 2T signal, e.g. at the video output of the IF stage, enables the following conclusions to be drawn:

- If the amplitude of the 2T signal is too high or too low, this points to amplitude errors; e.g. a tilt in the pass band of the SAW.
- Unsymmetrical overshoot in front of or behind the 2T signal arises through group delay errors (long wavelength errors, e.g. too little sag).
- Echo signals after the 2T signal point to poor reflection attenuation, e.g. of the triple-transit echo.

Naturally, these errors need not have been caused by the SAW filter. Unfavorable terminating filter impedances, detuned demodulator circuits, transmission errors from previous circuits and amplifiers, as well as power echos can cause the same effects.

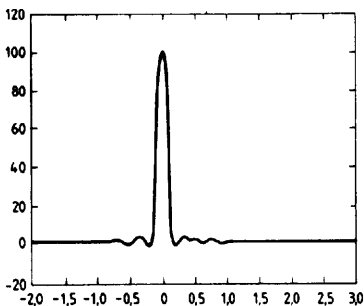

Figure 12
2T pulse simulated by computation

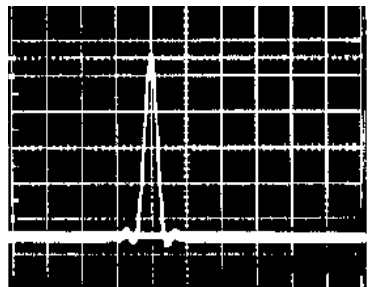

Figure 13
2T pulse measured on an IF board

General Technical Information

In the simulated 2T signal shown in Figure 12, the measured transfer function is demodulated whilst taking into account the group delay pre-distortion taken as the basis, by conjugating the transfer function at the Nyquist point, complex mirroring it and summing it. The video frequency response is now obtained, which is multiplied by the spectrum of the 2T pulse; the result is transformed into the time domain. The real component of the transformed signal is the 2T pulse response of the filter.

A figure of merit for the 2T signal is obtained from the K diagram, a tolerance diagram which is based on investigations of the interference effect of various transmission errors. Figure 14 shows the general K tolerance scheme for a 2T signal (time axis applies to the B/G standard).

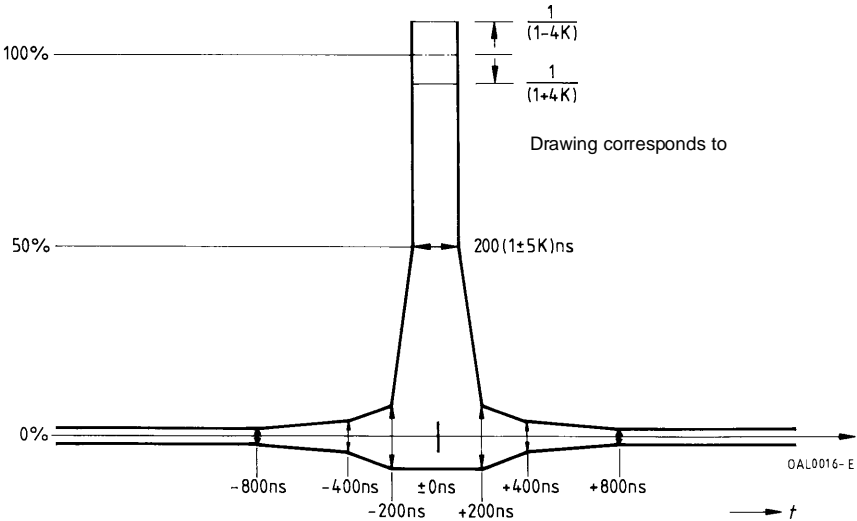

Figure 14
 K tolerance diagram
 S + M TV IF SAW filters comply with the $K = 2\%$ diagram

On the screen the **step signal** corresponds to a wide white bar at the left-hand edge. Mathematically speaking, it is the integral of the 2T signal; in principle, it therefore contains no additional information on the SAW filter. The different representation is often useful in assessing the interference effect of an error in the transmission system (see [3.7](#)).

In general, the following applies: the 2T signal is more suited for assessing a SAW filter, because it responds in a wide band to transmission errors in the pass band region. In addition, it reacts less noticeably to linearity errors in the IF IC and to envelope-curve effects in demodulation that could falsify the step signal more intensely. If reductions in the described errors are desired, to be able to better assess the effects generated by the SAW filter, it is recommended that the modulation factor of the IF modulator be reduced to $\leq 60\%$.

5 Application notes for TV IF SAW filters

5.1 Other operating conditions

All filter data quoted in the data sheets apply to the measuring conditions described. It is possible and sometimes necessary to operate the filters under different conditions. If you have any questions please contact your regional sales office. Upon request we are pleased to provide further information material, e.g. overall amplitude and time domain response.

5.2 Matching and driver stage

A low-impedance drive source is required in order to suppress the triple-transit signal. Base resistor R_1 provides the defined input impedance of 50Ω . To obtain a wide range of linearity, a drive current of approx. 20 mA is recommended. The gain can be adjusted by R_2 , not lower than 470Ω (e.g. 29 dB with $R_2 = 1,8 \text{ k}\Omega$). To guarantee a signal-to-intermodulation ratio of 50 dB, the input voltage V_{IN} should not exceed 80 mV. The inductivity L compensates the input capacitances of the SAW filter input and the transistor output.

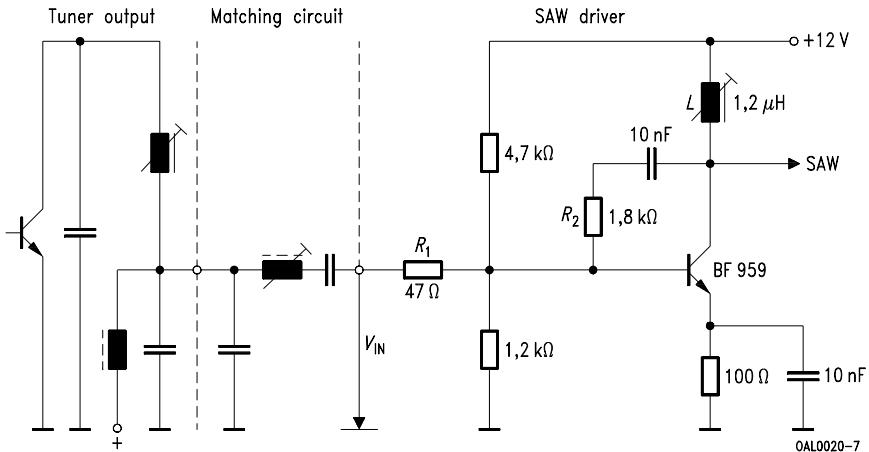

Figure 15
Tuner IF matching circuit and driver stage

5.3 Switchable video/intercarrier SAW filters for multistandard applications

The family of switchable video/intercarrier filters K 62xx K offers the possibility of switching between two filter characteristics. Figure 16 shows an example of a switching network using an unsymmetrical driver (see above):

To select the first channel the transistor T1 is in off-state and diode D1 connects pin 10 and pin 1. By activating T1 pin 10 is connected to ground and the other filter characteristic is selected.

These filters provide the unique advantage of an optimized frequency response for multistandard concepts using a simple and inexpensive switching network.

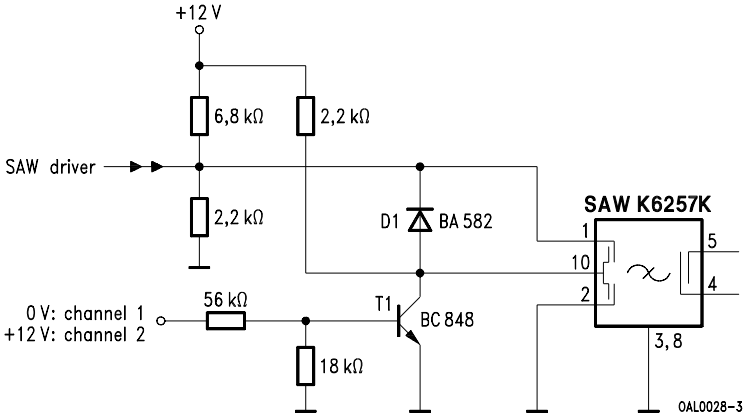

Figure 16
Switching network for a multistandard video filter

5.4 Switchable audio SAW filters for multistandard applications

Figure 17 shows a proposal for a switchable audio filter for unsymmetrical input. Two different filter characteristics are available in a SIP 5 K package:

To select channel 1 only diode D1 is activated, the corresponding transistor T1 is in off-state. That means that the input is connected to pin 1. Pin 2 is grounded by T2. Channel 2 can be chosen accordingly.

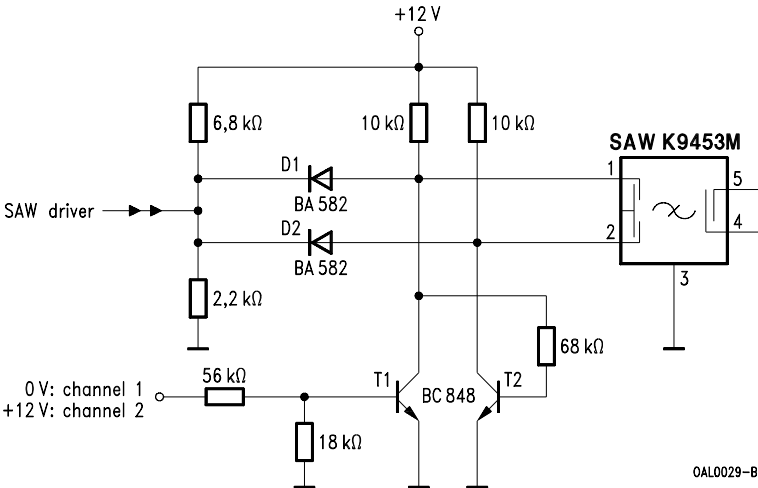

Figure 17
Switching network for a multistandard audio filter

6 Application notes for resonators and resonator filters

Principle: An oscillator is an amplifier with a signal feedback from the output to the input.

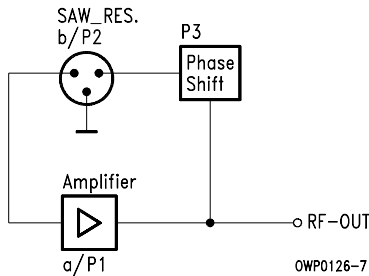

Figure 18
Basic circuit diagram

To achieve oscillation it is necessary to meet the following conditions:

Amplitude: $G = a + b > 1$
 Phase: $P_{tot} = P1 + P2 + P3 = n \cdot 360$

The amplitude condition means that the total gain G in the loop is greater than 1 and the phase condition postulates a total phase shift in the oscillator loop of $n \cdot 360^\circ$.

6.1 Typical oscillation circuits

6.1.1 Oscillators using a one-port resonator

The common base Colpitz circuit is one of the preferably used oscillating circuits for one-port resonators.

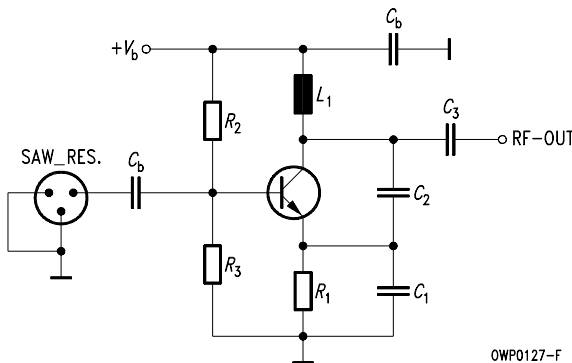

Figure 19
Colpitz with common base

General Technical Information

To achieve oscillation, the resonance frequency of the parallel resonance circuit should be near the SAW resonance frequency. Neglecting the internal transistor capacitances, the load and the PCB parasitics, the parallel resonance F_p of (C_1 serial C_2) and L_1 is determined by:

$$F_p = \frac{1}{2 \cdot \pi \cdot \sqrt{L_1 \cdot \frac{C_1 \cdot C_2}{C_1 + C_2}}}$$

R_1 , R_2 and R_3 are for DC biasing. C_3 matches the high collector impedance to the load impedance. The signal feedback depends on the relation of C_1 and C_2 .

The concrete values for C_1 , C_2 , C_3 and L_1 must be evaluated on the board to get the desired oscillation frequency.

The SMD transistor should be a high-frequency type with a transit frequency of a few GHz. Often it is possible to design the inductivity L_1 like a copper line on the PCB (without ground on the back-side). So you receive an antenna.

6.1.2 Oscillators using a two-port resonator

The typical circuit for two-port resonators is the Pierce oscillator.

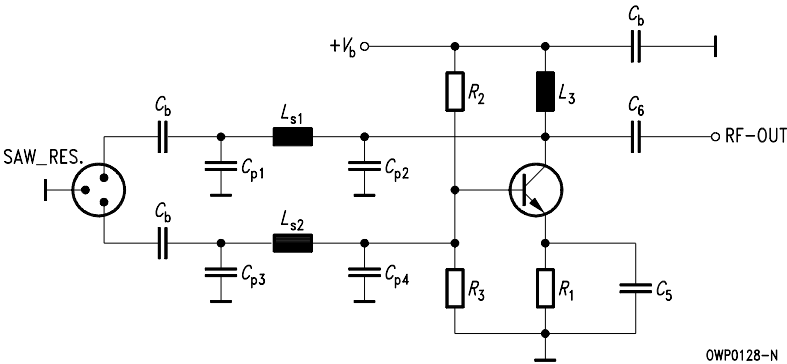

Figure 20
Pierce oscillator

The amplifier part of the oscillator is a transistor with grounded emitter. The SAW resonator is embedded between two π -type tuning networks. These networks control the phase shift in the feedback loop to meet the oscillation conditions. Otherwise they match the input and output impedance of the transistor to the desired impedance of the SAW resonator.

In the tuning network the parallel capacitors C_{p1} , C_{p2} , C_{p3} and C_{p4} are often substituted by the transistor's and the SAW resonator's input and output capacitors. The phase shift in the oscillating loop is controlled mainly by L_{s1}/C_{p1} and L_{s2}/C_{p3} . C_6 is for output matching and L_3 is for DC bypassing.

6.2 Application for a wireless remote control system at 433,92 MHz

Fields of application for SAW resonators are remote control systems for keyless entry, security systems and wireless telemetry.

Figure 21 and Figure 22 show an AM remote control system at 433,92 MHz. The transmitter is a SAW-stabilized oscillator with a PCB antenna, where a one-port SAW resonator is designed in, using the basic circuit of Figure 19. The modulation is OOK (On Off Keying). The receiver is a super-heterodyne receiver with an IF of 10,7 MHz. For preselection and rejection of the image frequency a SAW filter is designed in at the input. The local oscillator is stabilized by a SAW resonator.

For the transmitter and for the receiver it is necessary to provide a good common RF ground and short connections between the RF components. It is also recommended to separate the digital part from the RF part on the PCB. Both circuits are developed for small power consumption.

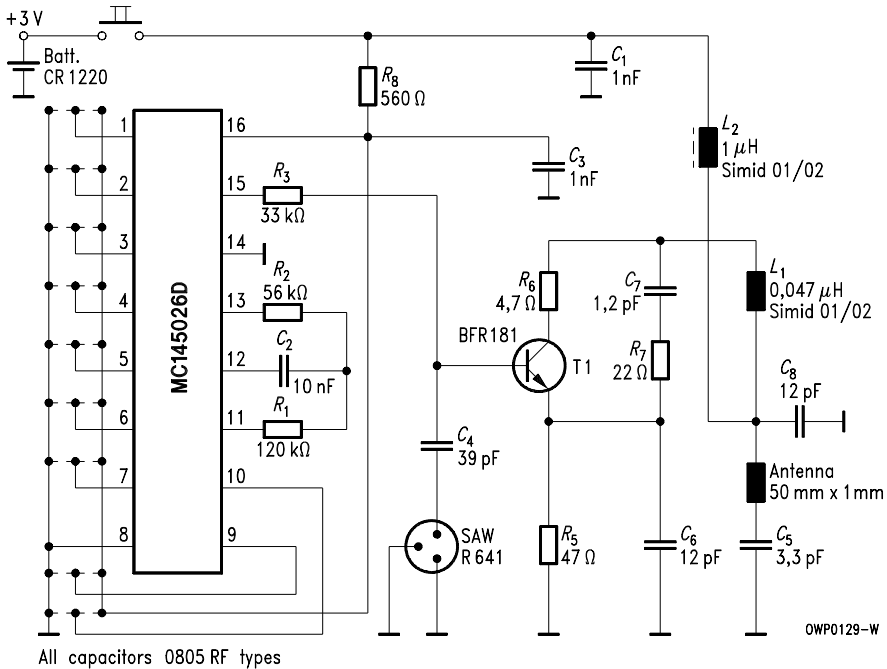

Figure 21
Remote control transmitter for 433,92 MHz

General Technical Information

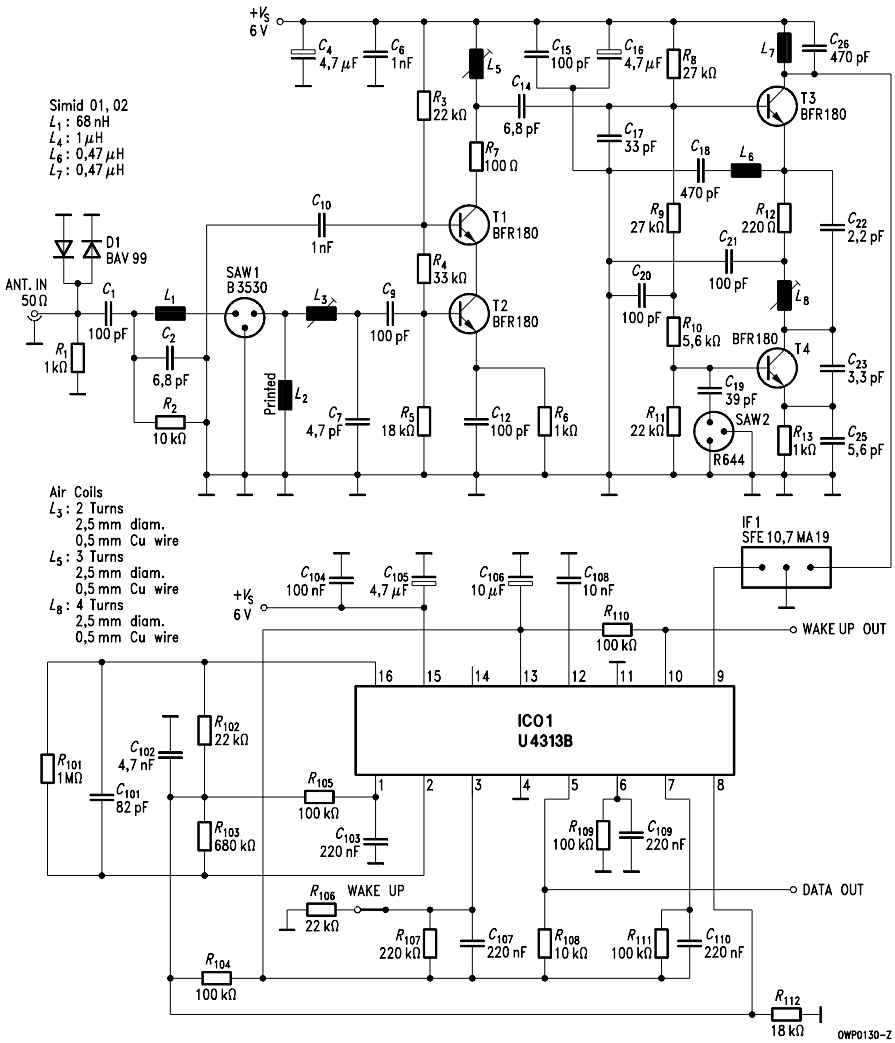

Figure 22
 Remote control receiver for 433,92 MHz

7 Date codes, packing units

7.1 Date codes

Date code information (year/month of production) is included in the marking of the SAW filters by using the codes below. As of 1 November 1996 most packages will also be marked with the day of production to enable better traceability. Example: 5H9 = 5 Sept 96

Year	Code	Month	Code	Day	Code	Day	Code
1987	V	January	1	1	1	17	H
1988	W	February	2	2	2	18	J
1989	X	March	3	3	3	19	K
1990	A	April	4	4	4	20	L
1991	B	May	5	5	5	21	M
1992	C	June	6	6	6	22	N
1993	D	July	7	7	7	23	P
1994	E	August	8	8	8	24	R
1995	F	September	9	9	9	25	S
1996	H	October	O	10	0	26	T
1997	J	November	N	11	A	27	U
1998	K	December	D	12	B	28	V
1999	L			13	C	29	W
				14	D	30	X
				15	E	31	Z
				16	F		

7.2 Packing units (pcs)

Package code	Package type	Packing unit	Package code	Package type	Packing unit
B110	TO 39	1000	X110	SIP 6 M	300 (75)
B210	TO 39	1000	X210	SIP 4 M	1000
B210 ¹⁾	TO 39	200 (25)	Z010	QCC 8	3000
B410 ¹⁾	TO 39	200 (25)	Z110	DCC 14	1500
B510	TO 39	1000	Z210	QCC 22	1500
C210	TO 8	200 (25)	Z310	QCC 18	1500
D210	DIP 14	100 (25)	Z410	QCC 10	1500
E110	DIP 16	100 (25)	Z510	QCC 12	1500
G310	DIP 24-06	80 (20)	M100 (Mxxx)	SIP 5 K	1000
G410	DIP 24-03	80 (20)	K100	DIP 10 K	500
X010	SIP 5 M	400	T901	SIP 5 K SMD	900

1) B55xx Clock recovery filters

General Technical Information

8 Quality

8.1 Delivery quality

The term delivery quality designates the conformance with agreed data at the time of delivery.

8.2 Certification

The Quality Management System of the SAW Components Division is certified to ISO 9001. Certification was carried out by the VDE Testing and Certification Institute, Offenbach/Main.

8.3 Qualification

The components are subjected by type groups to a qualifying test procedure, which conforms to all important tests specified in the relevant standards. Types for industrial applications are tested in accordance with MIL-STD-883 and MIL-S-49433. The group of types intended for applications in consumer electronics is tested in accordance with IEC 862-1.

8.4 Classification of defects

A component is considered defective if it does not comply with the specification stated in the data sheets or in an agreed delivery specification. Defectives can be divided into inoperatives, which generally exclude a functional application of the component and defectives of less significance.

Inoperatives are:

- short or open circuit
- broken components, broken package, broken terminals, broken encapsulation
- missing or incorrect marking
- intermixing with other component types

The remaining defectives can be divided into:

- electrical defectives
(maximum ratings exceeded)
- mechanical defectives
(incorrect dimensions, damaged package, illegible marking, bent leads)

8.5 Incoming inspection

If the user wishes to carry out an incoming inspection, the use of a sampling inspection plan in accordance with DIN 40 080 (content conforms to MIL-STD 105 D and IEC 410) is recommended.

8.6 Quality data

The information describes the type of component and shall not be considered as assured characteristics. As far as patents or other rights of third parties are concerned, liability is only assumed for the component per se, not for applications, processes and circuits implemented within components or assemblies. Conversely, an agreement as regards quality data does not exclude the possibility of the customer being able to claim replacement for individual defectives within the framework of the terms of delivery.

The following information is required for the assessment of possible claims: test circuit, sample size, number of defectives found, sample defectives.

IF Filters for Intercarrier Applications

Survey

Picture carrier	Picture-to-sound carrier distance	Group delay ¹⁾	Sound carrier rejection ²⁾	Standard ³⁾	Package	Type	Page ⁴⁾
MHz	MHz		dB				
33,90	- 6,5	F	50	L	SIP 5 K	K 2962 M	90
36,88	5,5	C	20	B	SIP 5 K	B 1952 M	49
38,00	6,5	N	21	D/K	SIP 5 K	D 1952 M	52
	5,5 ... 6,5	C	20, 21	D/K, B/G	SIP 5 K	K 2953 M	55
	5,5 ... 6,5	F	19, 21	D/K, B/G	SIP 5 K	K 2954 M	#
	5,5 ... 6,5	F	20, 20	D/K, B/G	SIP 5 K	K 2958 M	58
	4,5	C	22	M/N	DIP 10 K ⁵⁾	K 6265 K ⁶⁾	61
	5,5 ... 6,5	C	18, 21	D/K, B/G	DIP 10 K ⁵⁾	K 6265 K ⁶⁾	61
38,90	6,5	F	15	D/K	SIP 5 K	D 1990 M	#
	5,5	N	20	B/G	SIP 5 K	G 1872 M	#
	5,5	C	20	B/G	SIP 5 K	G 1875 M	66
	5,5	C	20	B/G	SIP 5 K	G 1960 M	#
	5,5	C	20	B/G	SIP 5 K	G 1961 M	#
	5,5	C	20	B/G	SIP 5 K	G 1962 M	69
	5,5	C	18	B/G	SIP 5 K	G 1963 M	#
	5,5	F	20	B/G	SIP 5 K	G 1965 M	72
	5,5	C	19	B/G	SIP 5 K	G 1966 M	75
	5,5	F	20	B/G	SIP 5 K	G 1967 M	#
	5,5	N	20	B/G	SIP 5 K	G 1968 M	78
	5,5	F	16	B/G	SIP 5 K	G 1980 M	#
	5,5 ... 5,85	C	14, 14	B/G NICAM	SIP 5 K	G 1984 M	#
	6,0	F	20	I	SIP 5 K	J 1952 M	81
	6,0	F	22	I	SIP 5 K	J 1955 M	#
	6,0 ... 6,55	F	14, 14	I NICAM	SIP 5 K	J 1980 M	84
	5,5 ... 6,5	F	21, 21	B/G, D/K	SIP 5 K	K 2951 M	#
	5,5 ... 6,5	C	21, 20	B/G, D/K	SIP 5 K	K 2955 M	87
	5,5 ... 6,5	C	14, 14	B/G, D/K	SIP 5 K	K 2960 M	#
	5,5 ... 6,5	F	15, 15	B/G, D/K	SIP 5 K	K 2962 M	90
	5,5	C	19	B/G	DIP 10 K ⁵⁾	K 6255 K ⁶⁾	93
	6,5	C	20	D/K	DIP 10 K ⁵⁾	K 6255 K ⁶⁾	93
	5,5	C	20	B/G	DIP 10 K ⁵⁾	K 6256 K ⁶⁾	98
	5,5 ... 6,5	C	18, 17	B/G	DIP 10 K ⁵⁾	K 6259 K ⁶⁾	#
	4,5	F	18	M/N	DIP 10 K ⁵⁾	K 6259 K ⁶⁾	#
	5,5	C	16	B/G	DIP 10 K ⁵⁾	K 6260 K ⁶⁾	#
4,5	F	17	M/N	DIP 10 K ⁵⁾	K 6262 K ⁶⁾	#	
4,5	C	21	M/N	SIP 5 K	M 1956 M	#	

continued on next page

1) N: Conforming with standard

C: Customized

F: Flat

2) Typ., referred to filter roof

3) For explanation of standards see individual data sheets or index on page [349](#)

4) Filters marked by the sign # are only listed in the survey. Detailed information on these types upon request.

5) Pin configuration different from standard package

6) Internally switchable multistandard filter

IF Filters for Intercarrier Applications

Survey

Picture carrier	Picture-to-sound carrier distance	Group delay ¹⁾	Sound carrier rejection ²⁾	Standard ³⁾	Package	Type	Page ⁴⁾
MHz	MHz		dB				
39,50	6,0	F	22	I	SIP 5 K	J 1951 M	103
	6,0	F	20	I	SIP 5 K	J 1953 M	#
45,75	4,5	F	17	M/N	SIP 5 K	M 1859 M	106
	4,5	F	17	M/N	SIP 5 K	M 1861 M	#
	4,5	F	20	M/N	SIP 5 K	M 1958 M	#
	4,5	F	20	M/N	SIP 5 K	M 1962 M	109
	4,5	F	20	M/N	SIP 5 K	M 1963 M	#
	4,5	C	19	M/N	SIP 5 K	M 1966 M	#
58,75	4,5	F	18	M	SIP 5 K	N 1951 M	112

1) N: Conforming with standard
C: Customized
F: Flat

2) Typ., referred to filter roof

3) For explanation of standards see individual data sheets or index on page [349](#)

4) Filters marked by the sign # are only listed in the survey. Detailed information on these types upon request.

Standard

- B-CCIR
Australia

Features

- TV IF filter with Nyquist slope and sound shelf
- Customized group delay predistortion

Terminals

- Tinned CuFe alloy

Plastic package **SIP 5 K**

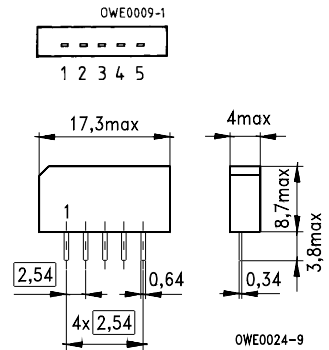

Dimensions in mm, approx. weight 1,0 g

Pin configuration

- 1 Input
- 2 Input – ground
- 3 Chip carrier – ground
- 4 Output
- 5 Output

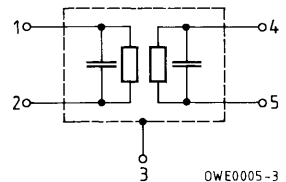

Type	Ordering code	Marking
B 1952 M	B39369-B1952-M100	Type, date code, pin 1

Maximum ratings

Ambient temperature	T_A	- 25/+ 65	°C	—
Storage temperature	T_{stg}	- 25/+ 85	°C	—
DC voltage	V_{DC}	12	V	between any terminals
AC voltage	V_{pp}	10	V	between any terminals

B 1952 M

36,875 MHz

Characteristics

Ambient temperature	$T_A = 25\text{ °C}$
Source impedance	$Z_S = 50\ \Omega$
Load impedance	$Z_L = 2\text{ k}\Omega \parallel 3\text{ pF}$

		min.	typ.	max.	
Insertion attenuation					
Reference level for the following data	35,38 MHz	15,8	17,3	18,8	dB
Relative attenuation					
Picture carrier	36,88 MHz	4,8	5,8	6,8	dB
Color carrier	32,45 MHz	2,2	3,2	4,2	dB
Sound carrier	31,38 MHz	19,0	20,0	21,0	dB
Adjacent picture carrier	29,88 MHz	46,0	56,0	—	dB
Adjacent sound carrier	38,38 MHz	42,0	56,0	—	dB
Lower sidelobe	25,00 ... 29,88 MHz	40,0	46,0	—	dB
Upper sidelobe	38,38 ... 45,00 MHz	36,0	41,0	—	dB
Reflected wave signal suppression					
1,2 μ s ... 6,0 μ s after main pulse (test pulse: 250 ns, carrier frequency: 35,38 MHz)		42,0	52,0	—	dB
Feedthrough signal suppression					
1,2 μ s ... 1,1 μ s before main pulse (test pulse: 250 ns, carrier frequency: 35,38 MHz)		50,0	56,0	—	dB
Group delay predistortion					
(reference frequency 36,88 MHz)					
	34,38 MHz	—	-35	—	ns
	32,45 MHz	—	80	—	ns
Impedance at 35,38 MHz					
Input: $Z_{IN} = R_{IN} \parallel C_{IN}$		—	2,3 \parallel 10,8	—	—
Output: $Z_{OUT} = R_{OUT} \parallel C_{OUT}$		—	2,8 \parallel 2,9	—	—
Temperature coefficient of frequency					
	TC_f	—	-72	—	ppm/K

Frequency response

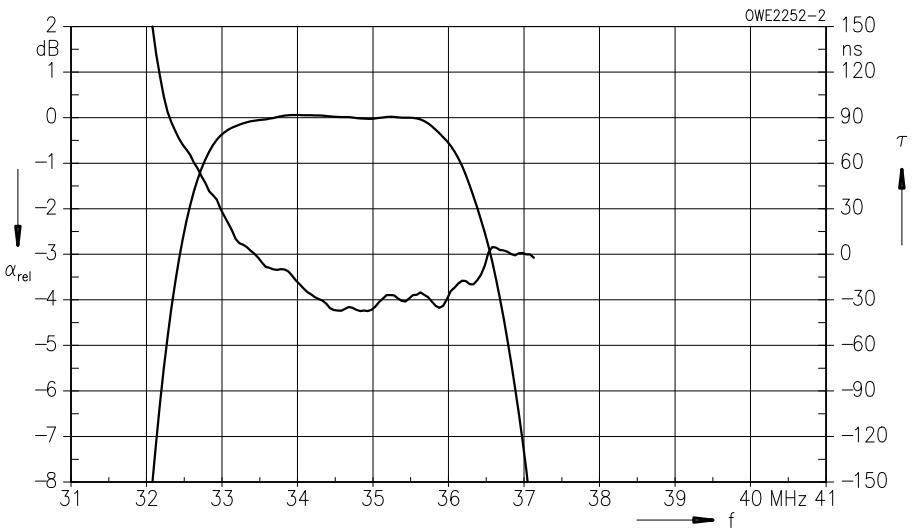
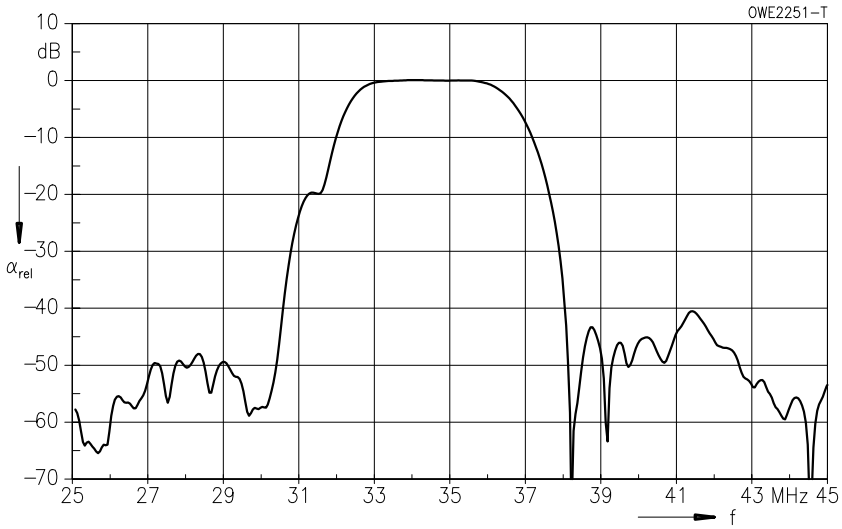

Standard

- D/K-OIRT
Eastern standard, China

Features

- TV IF filter with Nyquist slope and sound shelf
- Group delay predistortion according standard D/K, half, CCIR report 308

Terminals

- Tinned CuFe alloy

Plastic package **SIP 5 K**

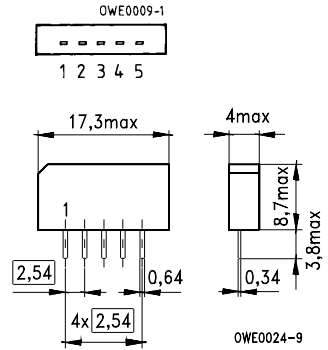

Dimensions in mm, approx. weight 1,0 g

Pin configuration

- 1 Input
- 2 Input – ground
- 3 Chip carrier – ground
- 4 Output
- 5 Output

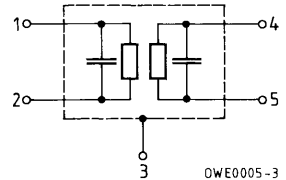

Type	Ordering code	Marking
D 1952 M	B39380-D1952-M100	Type, date code, pin 1

Maximum ratings

Ambient temperature	T_A	- 25/+ 65	°C	—
Storage temperature	T_{stg}	- 25/+ 85	°C	—
DC voltage	V_{DC}	12	V	between any terminals
AC voltage	V_{pp}	10	V	between any terminals

Characteristics

Ambient temperature $T_A = 25\text{ °C}$
 Source impedance $Z_S = 50\ \Omega$
 Load impedance $Z_L = 2\text{ k}\Omega \parallel 3\text{ pF}$

		min.	typ.	max.	
Insertion attenuation					
Reference level for the following data	35,00 MHz	α 15,0	16,7	18,0	dB
Relative attenuation					
Picture carrier	38,00 MHz	α_{rel} 4,3	5,3	6,3	dB
Color carrier	33,57 MHz	0,3	1,3	2,3	dB
Sound carrier	31,50 MHz	19,7	20,7	21,7	dB
Adjacent picture carrier	30,00 MHz	46,0	51,0	—	dB
Adjacent sound carrier	39,50 MHz	44,0	52,0	—	dB
Lower sidelobe	25,00 ... 30,00 MHz	41,0	45,0	—	dB
Upper sidelobe	39,50 ... 45,00 MHz	35,0	39,0	—	dB
Reflected wave signal suppression					
1,2 μ s ... 6,0 μ s after main pulse (test pulse: 250 ns, carrier frequency: 35,00 MHz)		44,0	55,0	—	dB
Feedthrough signal suppression					
1,0 μ s ... 0,9 μ s before main pulse (test pulse: 250 ns, carrier frequency: 35,00 MHz)		50,0	56,0	—	dB
Group delay predistortion					
(reference frequency 38,00 MHz)		$\Delta\tau$			
	35,60 MHz	—	-60	—	ns
	33,57 MHz	—	5	—	ns
Impedance at 35,00 MHz					
Input: $Z_{IN} = R_{IN} \parallel C_{IN}$		—	2,8 \parallel 12,0	—	k Ω \parallel pF
Output: $Z_{OUT} = R_{OUT} \parallel C_{OUT}$		—	1,5 \parallel 5,5	—	k Ω \parallel pF
Temperature coefficient of frequency		TC_f	-72	—	ppm/K

Frequency response

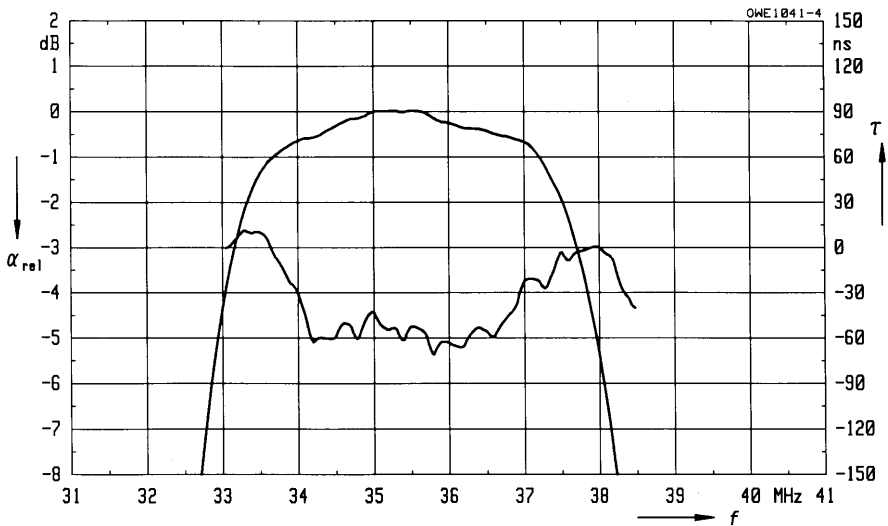
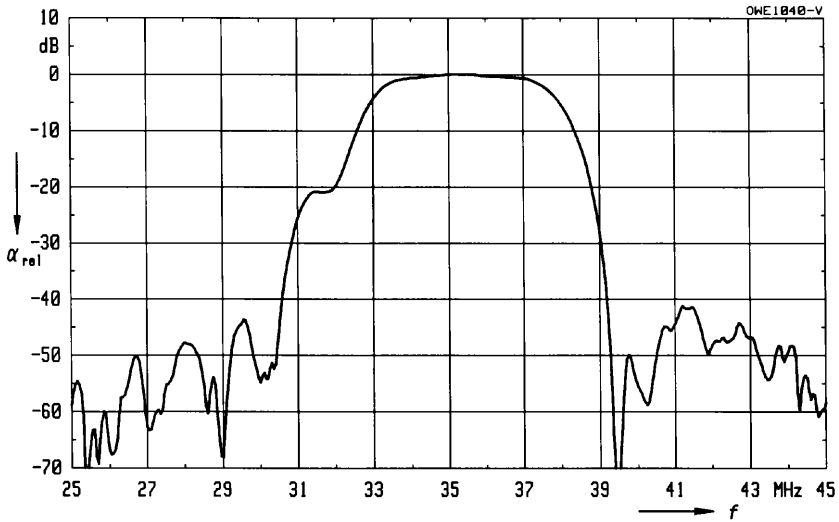

Standard

- D/K-OIRT
Eastern standard
- B/G-CCIR
Europe partly

Features

- TV IF filter with Nyquist slope and sound shelf
- Broad sound shelf for sound carriers at 31,50 MHz and 32,50 MHz
- Customized group delay predistortion

Terminals

- Tinned CuFe alloy

Plastic package **SIP 5 K**

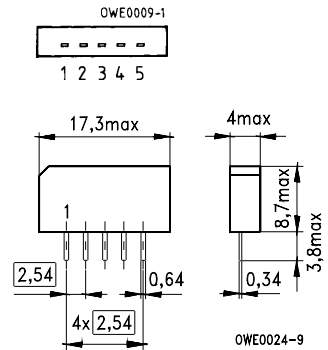

Dimensions in mm, approx. weight 1,0 g

Pin configuration

- 1 Input
- 2 Input – ground
- 3 Chip carrier – ground
- 4 Output
- 5 Output

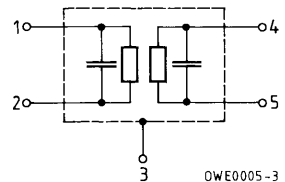

Type	Ordering code	Marking
K 2953 M	B39380-K2953-M100	Type, date code, pin 1

Maximum ratings

Ambient temperature	T_A	- 25/+ 65	°C	–
Storage temperature	T_{stg}	- 25/+ 85	°C	–
DC voltage	V_{DC}	12	V	between any terminals
AC voltage	V_{pp}	10	V	between any terminals

K 2953 M

38,00 MHz

Characteristics

Ambient temperature $T_A = 25\text{ °C}$
 Source impedance $Z_S = 50\ \Omega$
 Load impedance $Z_L = 2\text{ k}\Omega \parallel 3\text{ pF}$

		min.	typ.	max.	
Insertion attenuation					
Reference level for the following data	36,50 MHz	α 14,8	16,3	17,8	dB
Relative attenuation					
Picture carrier	38,00 MHz	α_{rel} 4,4	5,4	6,4	dB
Color carrier	33,57 MHz	2,1	3,1	4,1	dB
	33,20 MHz	—	8,8	—	dB
Sound carrier	31,50 MHz	—	20,6	—	dB
	32,50 MHz	18,6	19,6	20,6	dB
Adjacent picture carrier	30,00 MHz	46,0	55,0	—	dB
Adjacent sound carrier	39,50 MHz	44,0	53,0	—	dB
Lower sidelobe	25,00 ... 30,00 MHz	39,0	46,0	—	dB
Upper sidelobe	39,50 ... 45,00 MHz	36,0	43,0	—	dB
Reflected wave signal suppression					
1,1 μ s ... 6,0 μ s after main pulse (test pulse: 250 ns, carrier frequency: 36,50 MHz)		44,0	55,0	—	dB
Feedthrough signal suppression					
1,1 μ s ... 1,0 μ s before main pulse (test pulse: 250 ns, carrier frequency: 36,50 MHz)		50,0	56,0	—	dB
Group delay pre-distortion					
(reference frequency 38,00 MHz)		$\Delta\tau$			
	34,20 MHz	—	- 85	—	ns
	33,57 MHz	—	- 30	—	ns
Impedance at 36,50 MHz					
Input: $Z_{IN} = R_{IN} \parallel C_{IN}$		—	1,4 \parallel 13,2	—	k Ω \parallel pF
Output: $Z_{OUT} = R_{OUT} \parallel C_{OUT}$		—	2,5 \parallel 4,0	—	k Ω \parallel pF
Temperature coefficient of frequency					
		TC_f	- 72	—	ppm/K

Frequency response

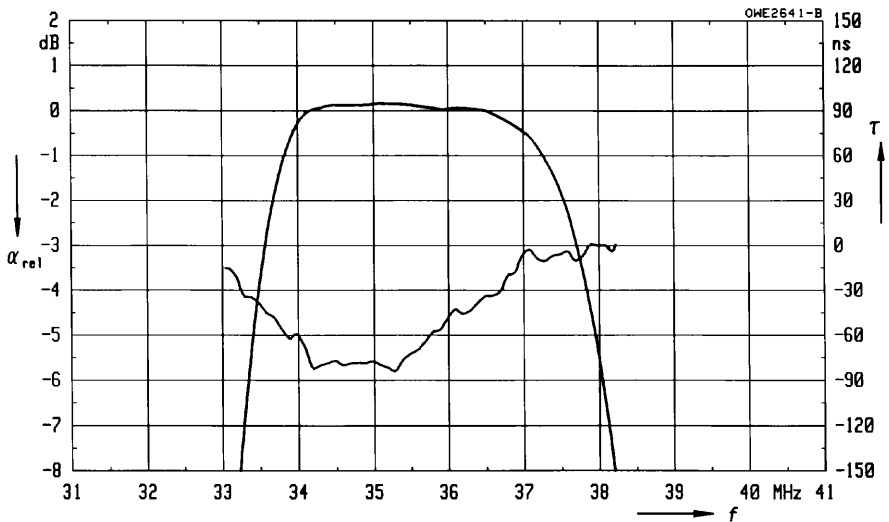
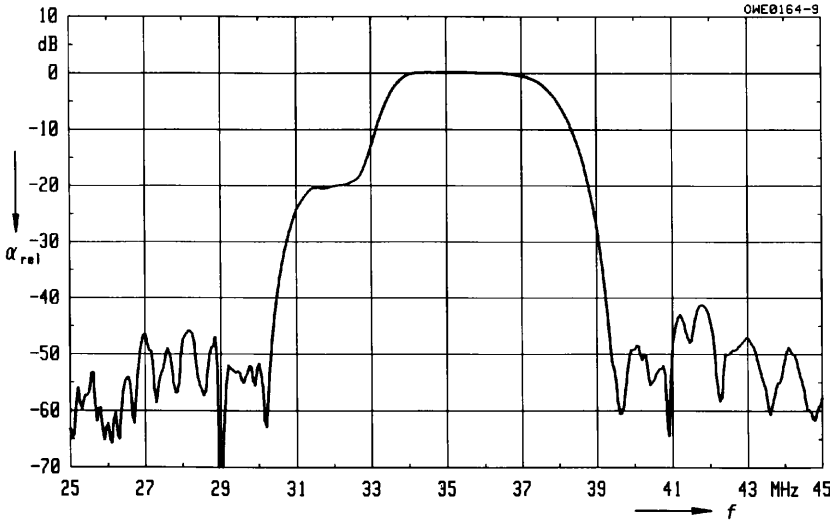

Standard

- D/K-OIRT
Eastern standard
- B/G-CCIR
Europe partly

Features

- TV IF filter with Nyquist slope and sound shelf
- Broad sound shelf for sound carriers
at 31,50 MHz and 32,50 MHz
- High color carrier level
- Constant group delay

Terminals

- Tinned CuFe alloy

Plastic package **SIP 5 K**

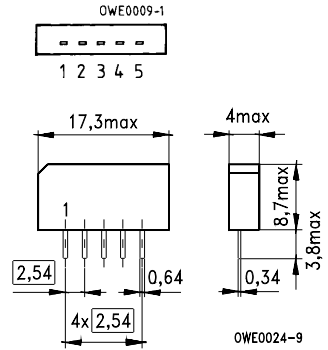

Dimensions in mm, approx. weight 1,0 g

Pin configuration

- 1 Input
- 2 Input – ground
- 3 Chip carrier – ground
- 4 Output
- 5 Output

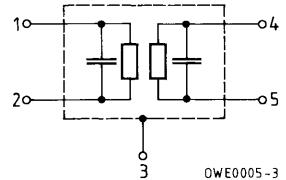

Type	Ordering code	Marking
K 2958 M	B39380-K2958-M100	Type, date code, pin 1

Maximum ratings

Ambient temperature	T_A	- 25/+ 65	°C	—
Storage temperature	T_{stg}	- 25/+ 85	°C	—
DC voltage	V_{DC}	12	V	between any terminals
AC voltage	V_{pp}	10	V	between any terminals

Characteristics

Ambient temperature $T_A = 25\text{ °C}$
 Source impedance $Z_S = 50\ \Omega$
 Load impedance $Z_L = 2\text{ k}\Omega \parallel 3\text{ pF}$

		min.	typ.	max.		
Insertion attenuation						
Reference level for the following data	36,50 MHz	α	16,1	17,6	19,1	dB
Relative attenuation						
Picture carrier	38,00 MHz	α_{rel}	5,0	6,0	7,0	dB
Color carrier	33,57 MHz		0,4	1,4	2,4	dB
Sound carrier	31,50 MHz		18,7	20,2	21,7	dB
	32,50 MHz		18,3	19,8	21,3	dB
Adjacent picture carrier	30,00 MHz		46,0	60,0	—	dB
Adjacent sound carrier	39,50 MHz		42,0	55,0	—	dB
Lower sidelobe	25,00 ... 30,00 MHz		41,0	47,0	—	dB
Upper sidelobe	39,50 ... 45,00 MHz		37,0	43,0	—	dB
Reflected wave signal suppression						
1,1 μ s ... 6,0 μ s after main pulse (test pulse: 250 ns, carrier frequency: 36,50 MHz)			42,0	52,0	—	dB
Feedthrough signal suppression						
1,1 μ s ... 1,0 μ s before main pulse (test pulse: 250 ns, carrier frequency: 36,50 MHz)			50,0	56,0	—	dB
Group delay ripple (p-p)		$\Delta\tau$	—	50	—	ns
Impedance at 36,50 MHz						
Input: $Z_{IN} = R_{IN} \parallel C_{IN}$			—	2,1 \parallel 11,0	—	k Ω \parallel pF
Output: $Z_{OUT} = R_{OUT} \parallel C_{OUT}$			—	4,3 \parallel 2,7	—	k Ω \parallel pF
Temperature coefficient of frequency		TC_f	—	-72	—	ppm/K

Frequency response

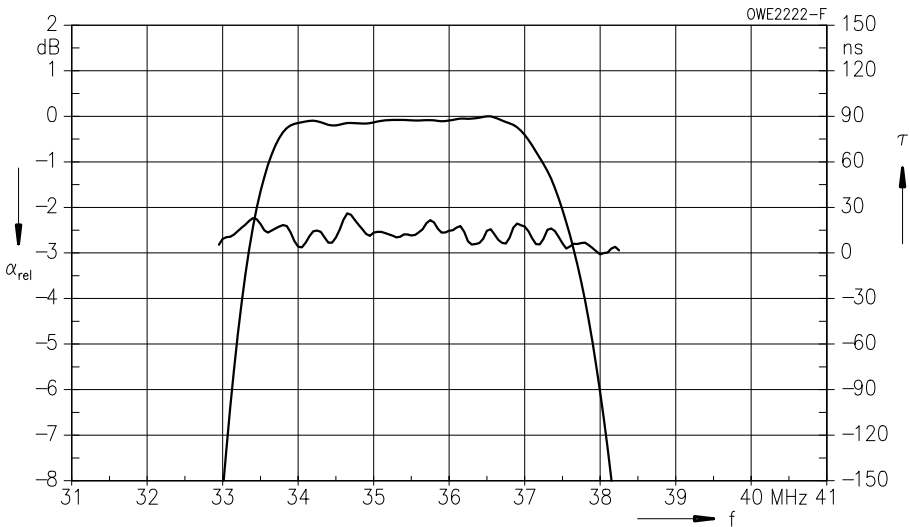
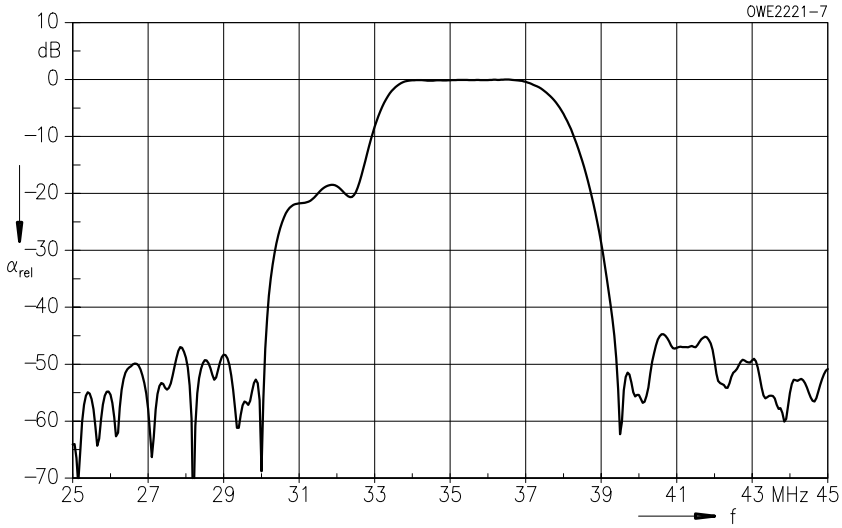

Standard

- D/K-OIRT
Eastern standard
- B/G-CCIR
Europe partly
- M/N-FCC
USA

Plastic package DIP 10 K

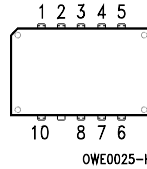

Features

- TV IF filter switchable from M/N mode to D/K mode
- M/N mode with Nyquist slope and sound shelf at 33,50 MHz
- Customized group delay predistortion
- D/K mode with Nyquist slope and broad sound shelf for sound carriers at 31,50 MHz and 32,50 MHz
- Customized group delay predistortion

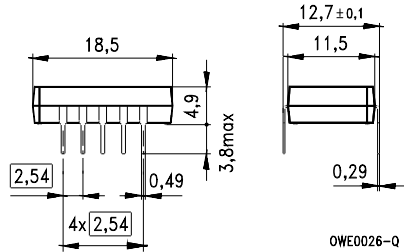

Terminals

- Tinned CuFe alloy

Dimensions in mm, approx. weight 1,8 g

Pin configuration

- 1 Input
- 2 Input – ground
- 3, 8 Chip carrier – ground
- 4, 5 Output
- 6, 7 Not connected
- 9 Free
- 10 Switching input

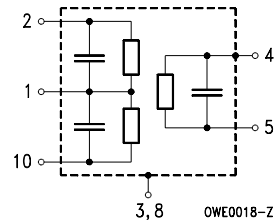

Type	Ordering code	Marking
K 6265 K	B39380-K6265-K100	Type, date code, pin 1

Maximum ratings

Ambient temperature	T_A	- 25/+ 65	°C	—
Storage temperature	T_{stg}	- 25/+ 85	°C	—
DC voltage	V_{DC}	12	V	between any terminals
AC voltage	V_{pp}	10	V	between any terminals

K 6265 K

38,00 MHz

Characteristics in M/N mode (switching input pin 10 connected to input pin 1)

Ambient temperature $T_A = 25\text{ °C}$
 Source impedance $Z_S = 50\ \Omega$
 Load impedance $Z_L = 2\text{ k}\Omega \parallel 3\text{ pF}$

		min.	typ.	max.	
Insertion attenuation					
Reference level for the following data	36,50 MHz	15,4	16,9	18,4	dB
Relative attenuation					
Picture carrier	38,00 MHz	5,0	6,0	7,0	dB
Color carrier	34,42 MHz	4,6	5,6	6,6	dB
Sound carrier	33,50 MHz	20,0	22,0	24,0	dB
Adjacent picture carrier	32,00 MHz	37,0	43,0	—	dB
Adjacent sound carrier	39,50 MHz	46,0	60,0	—	dB
Lower sidelobe	25,00 ... 32,00 MHz	35,0	41,0	—	dB
Upper sidelobe	39,50 ... 45,00 MHz	38,0	45,0	—	dB
Reflected wave signal suppression					
1,2 μ s ... 6,0 μ s after main pulse (test pulse: 250 ns, carrier frequency: 36,50 MHz)		42,0	49,0	—	dB
Feedthrough signal suppression					
1,3 μ s ... 1,2 μ s before main pulse (test pulse: 250 ns, carrier frequency: 36,50 MHz)		—	56,0	—	dB
Group delay predistortion					
(reference frequency 38,00 MHz)					
	36,00 MHz	—	0	—	ns
	34,42 MHz	—	0	—	ns
Impedance at 36,50 MHz					
Input: $Z_{IN} = R_{IN} \parallel C_{IN}$		—	0,9 \parallel 21,7	—	k Ω \parallel pF
Output: $Z_{OUT} = R_{OUT} \parallel C_{OUT}$		—	1,4 \parallel 5,9	—	k Ω \parallel pF
Temperature coefficient of frequency					
	TC_f	—	-72	—	ppm/K

Frequency response (M/N mode)

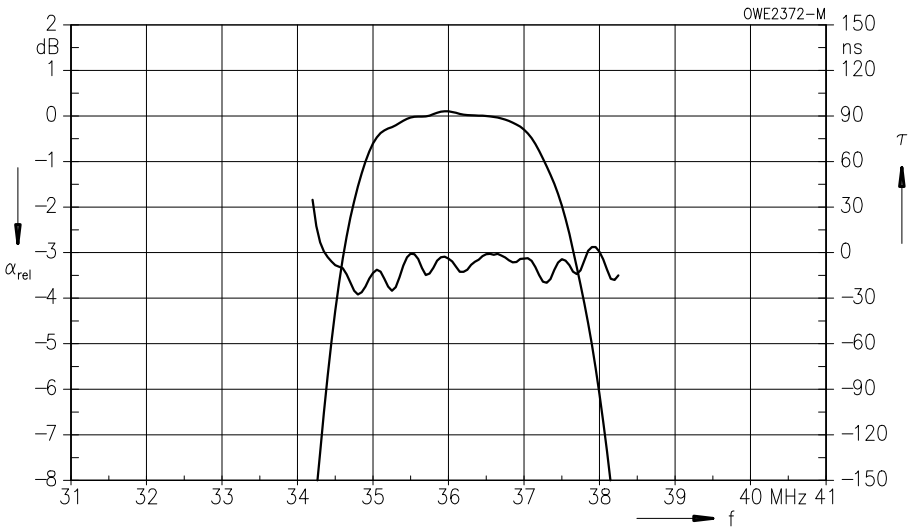
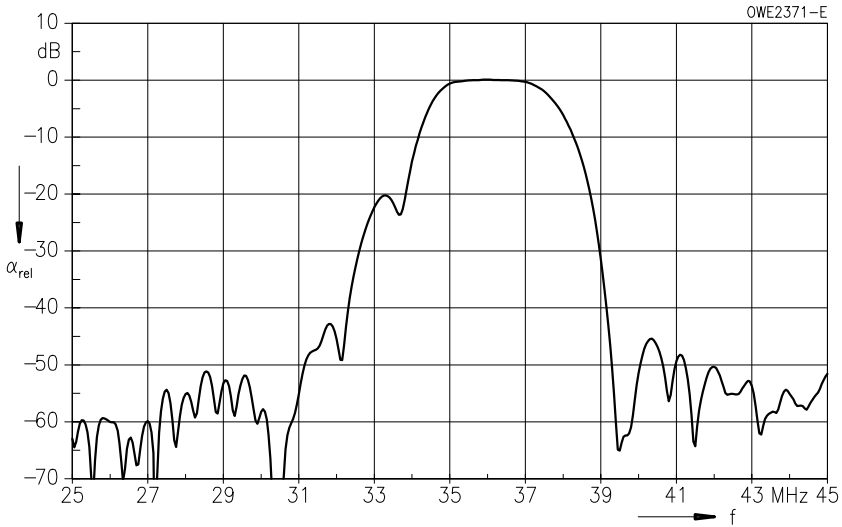

K 6265 K

38,00 MHz

Characteristics in D/K mode (switching input pin 10 connected to ground input pin 2)

Ambient temperature $T_A = 25\text{ }^\circ\text{C}$
 Source impedance $Z_S = 50\ \Omega$
 Load impedance $Z_L = 2\ \text{k}\Omega \parallel 3\ \text{pF}$

		min.	typ.	max.	
Insertion attenuation					
Reference level for the following data	36,50 MHz	α 15,3	16,8	18,3	dB
Relative attenuation					
Picture carrier	38,00 MHz	α_{rel} 5,3	6,3	7,3	dB
Color carrier	33,57 MHz	0,8	1,8	2,8	dB
Sound carrier	31,50 MHz	18,7	20,7	22,7	dB
	32,50 MHz	15,9	17,9	19,9	dB
Adjacent picture carrier	30,00 MHz	46,0	54,0	—	dB
	31,00 MHz	40,0	50,0	—	dB
Adjacent sound carrier	39,50 MHz	44,0	55,0	—	dB
Lower sidelobe	25,00 ... 30,00 MHz	39,0	45,0	—	dB
Upper sidelobe	39,50 ... 45,00 MHz	37,0	43,0	—	dB
Reflected wave signal suppression					
1,2 μs ... 6,0 μs after main pulse (test pulse: 250 ns, carrier frequency: 36,50 MHz)		42,0	50,0	—	dB
Feedthrough signal suppression					
1,3 μs ... 1,2 μs before main pulse (test pulse: 250 ns, carrier frequency: 36,50 MHz)		—	56,0	—	dB
Group delay pre-distortion					
(reference frequency 38,00 MHz)		$\Delta\tau$			
	34,50 MHz	—	- 80	—	ns
	33,57 MHz	—	- 20	—	ns
Impedance at 36,50 MHz					
Input: $Z_{\text{IN}} = R_{\text{IN}} \parallel C_{\text{IN}}$		—	0,6 \parallel 27,0	—	$\text{k}\Omega \parallel \text{pF}$
Output: $Z_{\text{OUT}} = R_{\text{OUT}} \parallel C_{\text{OUT}}$		—	1,4 \parallel 5,9	—	$\text{k}\Omega \parallel \text{pF}$
Temperature coefficient of frequency					
		TC_f	- 72	—	ppm/K

Frequency response (D/K mode)

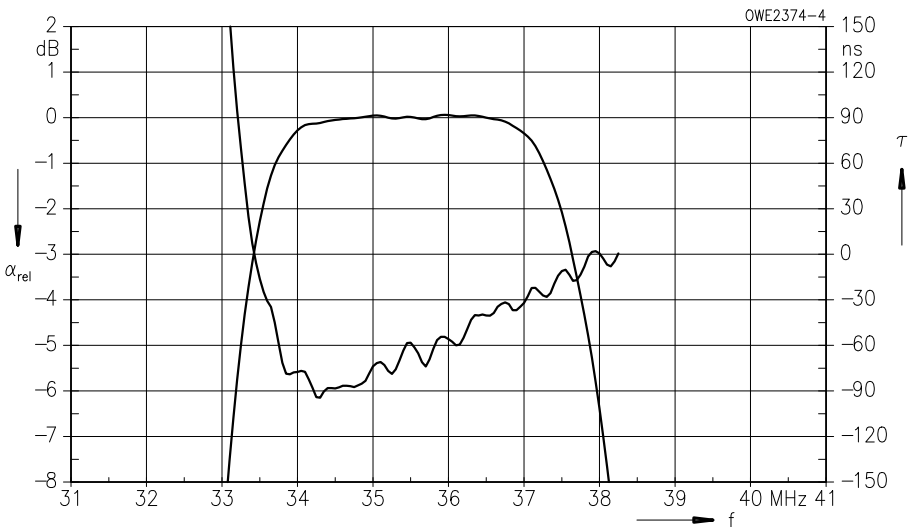
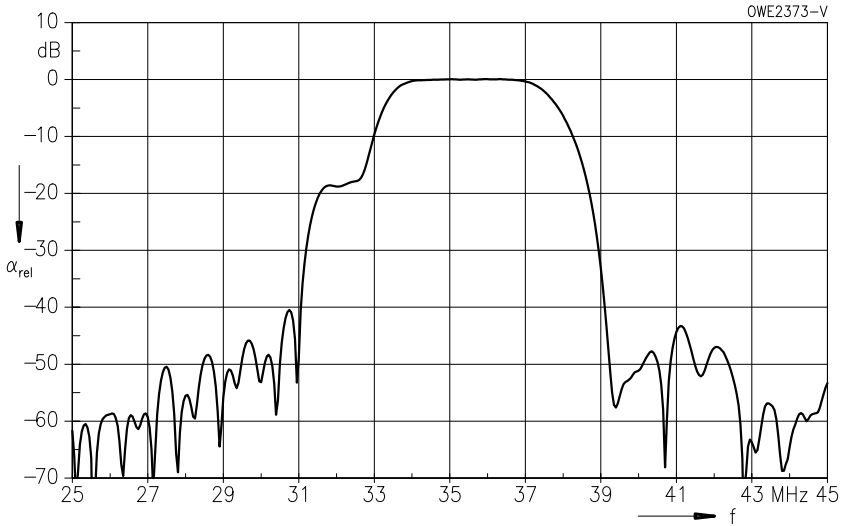

Standard

- B/G-CCIR
Germany, Europe partly

Features

- TV IF filter with Nyquist slope and sound shelf
- Reduced group delay predistortion as compared with standard B/G, half

Terminals

- Tinned CuFe alloy

Plastic package **SIP 5 K**

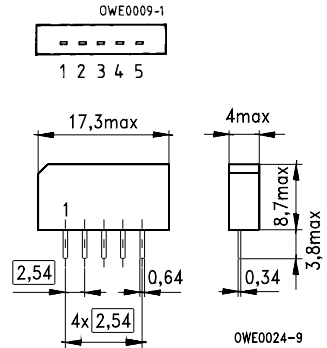

Dimensions in mm, approx. weight 1,0 g

Pin configuration

- 1 Input
- 2 Input – ground
- 3 Chip carrier – ground
- 4 Output
- 5 Output

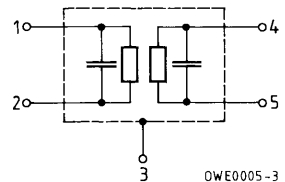

Type	Ordering code	Marking
G 1875 M	B39389-G1875-M100	Type, date code, pin 1

Maximum ratings

Ambient temperature	T_A	- 25/+ 65	°C	–
Storage temperature	T_{stg}	- 25/+ 85	°C	–
DC voltage	V_{DC}	12	V	between any terminals
AC voltage	V_{pp}	10	V	between any terminals

Characteristics

Ambient temperature $T_A = 25\text{ }^\circ\text{C}$
 Source impedance $Z_S = 50\ \Omega$
 Load impedance $Z_L = 2\ \text{k}\Omega \parallel 3\ \text{pF}$

		min.	typ.	max.		
Insertion attenuation						
Reference level for the following data	37,40 MHz	α	16,9	17,4	18,9	dB
Relative attenuation						
Picture carrier	38,90 MHz	α_{rel}	4,5	5,5	6,5	dB
Color carrier	34,47 MHz		1,6	2,6	3,6	dB
Sound carrier	33,40 MHz		18,7	19,7	20,7	dB
Adjacent picture carrier	UHF 30,90 MHz		44,0	55,0	—	dB
	VHF 31,90 MHz		44,0	57,0	—	dB
Adjacent sound carrier	VHF 40,15 MHz		36,0	44,0	—	dB
	VHF 40,40 MHz		40,0	50,0	—	dB
Lower sidelobe	UHF 41,40 MHz		40,0	50,0	—	dB
	25,00 ... 31,90 MHz		40,0	47,0	—	dB
Upper sidelobe	40,40 ... 45,00 MHz		36,0	43,0	—	dB
Reflected wave signal suppression						
1,0 μs ... 6,0 μs after main pulse (test pulse: 250 ns, carrier frequency: 37,40 MHz)			42,0	52,0	—	dB
Feedthrough signal suppression						
1,0 μs ... 0,9 μs before main pulse (test pulse: 250 ns, carrier frequency: 37,40 MHz)			50,0	56,0	—	dB
Group delay predistortion						
(reference frequency 38,90 MHz)		$\Delta\tau$				
	36,90 MHz		—	-50	—	ns
	34,47 MHz		—	70	—	ns
Impedance at 37,40 MHz						
Input: $Z_{\text{IN}} = R_{\text{IN}} \parallel C_{\text{IN}}$			—	2,5 \parallel 9,5	—	$\text{k}\Omega \parallel \text{pF}$
Output: $Z_{\text{OUT}} = R_{\text{OUT}} \parallel C_{\text{OUT}}$			—	2,9 \parallel 2,6	—	$\text{k}\Omega \parallel \text{pF}$
Temperature coefficient of frequency		TC_f	—	-72	—	ppm/K

Frequency response

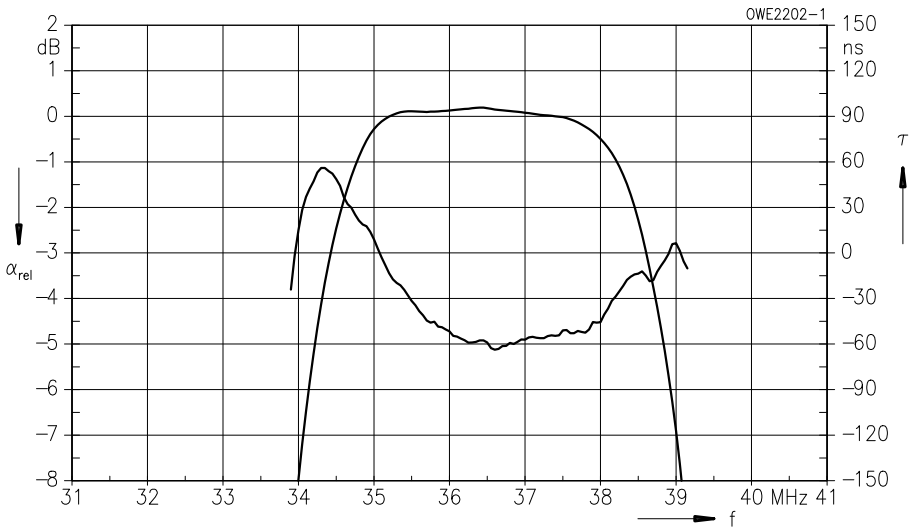
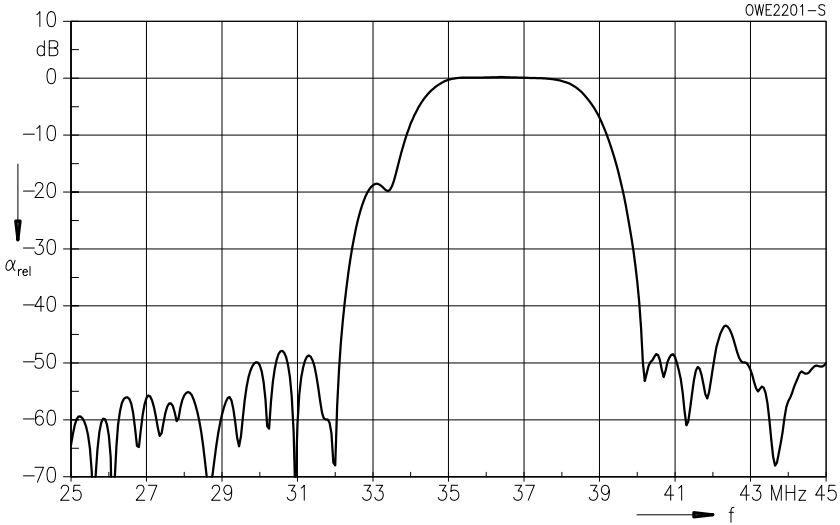

Standard

- B/G-CCIR
Germany, Europe partly

Features

- TV IF filter with Nyquist slope and sound shelf
- Highly reduced group delay predistortion as compared with standard B/G, half
- Suitable for CENELEC EN 55020

Terminals

- Tinned CuFe alloy

Plastic package **SIP 5 K**

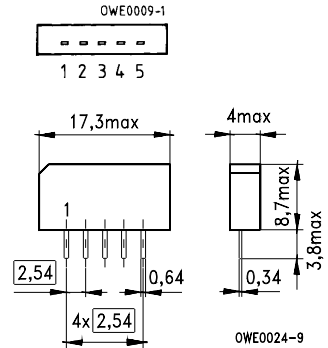

Dimensions in mm, approx. weight 1,0 g

Pin configuration

- 1 Input
- 2 Input – ground
- 3 Chip carrier – ground
- 4 Output
- 5 Output

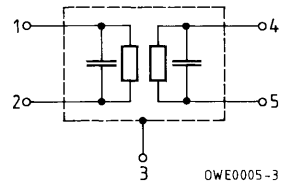

Type	Ordering code	Marking
G 1962 M	B39389-G1962-M100	Type, date code, pin 1

Maximum ratings

Ambient temperature	T_A	- 25/+ 65	°C	—
Storage temperature	T_{stg}	- 25/+ 85	°C	—
DC voltage	V_{DC}	12	V	between any terminals
AC voltage	V_{pp}	10	V	between any terminals

G 1962 M

38,90 MHz

Characteristics

Ambient temperature	$T_A = 25\text{ °C}$
Source impedance	$Z_S = 50\ \Omega$
Load impedance	$Z_L = 2\text{ k}\Omega \parallel 3\text{ pF}$

		min.	typ.	max.	
Insertion attenuation					
Reference level for the following data	37,40 MHz	13,5	15,1	16,5	dB
Relative attenuation					
Picture carrier	38,90 MHz	4,9	5,9	6,9	dB
Color carrier	34,47 MHz	1,3	2,3	3,3	dB
Sound carrier	33,40 MHz	18,5	19,5	20,5	dB
Adjacent picture carrier	UHF 30,90 MHz	46,0	52,0	—	dB
	VHF 31,90 MHz	48,0	54,0	—	dB
	31,40 MHz	46,0	52,0	—	dB
	32,40 MHz	48,0	56,0	—	dB
	40,15 MHz	42,0	49,0	—	dB
Adjacent sound carrier	VHF 40,40 MHz	46,0	58,0	—	dB
	UHF 41,40 MHz	42,0	52,0	—	dB
Lower sidelobe	25,00 ... 31,40 MHz	42,0	47,0	—	dB
Upper sidelobe	40,40 ... 45,00 MHz	38,0	43,0	—	dB
Reflected wave signal suppression					
1,3 μ s ... 6,0 μ s after main pulse (test pulse: 250 ns, carrier frequency: 37,40 MHz)		44,0	54,0	—	dB
Feedthrough signal suppression					
1,3 μ s ... 1,2 μ s before main pulse (test pulse: 250 ns, carrier frequency: 37,40 MHz)		50,0	56,0	—	dB
Group delay predistortion					
(reference frequency 38,90 MHz)					
	36,90 MHz	—	- 70	—	ns
	34,47 MHz	—	30	—	ns
Impedance at 37,40 MHz					
Input: $Z_{IN} = R_{IN} \parallel C_{IN}$		—	2,2 \parallel 13,3	—	k Ω \parallel pF
Output: $Z_{OUT} = R_{OUT} \parallel C_{OUT}$		—	1,4 \parallel 4,7	—	k Ω \parallel pF
Temperature coefficient of frequency					
	TC_f	—	- 72	—	ppm/K

Frequency response

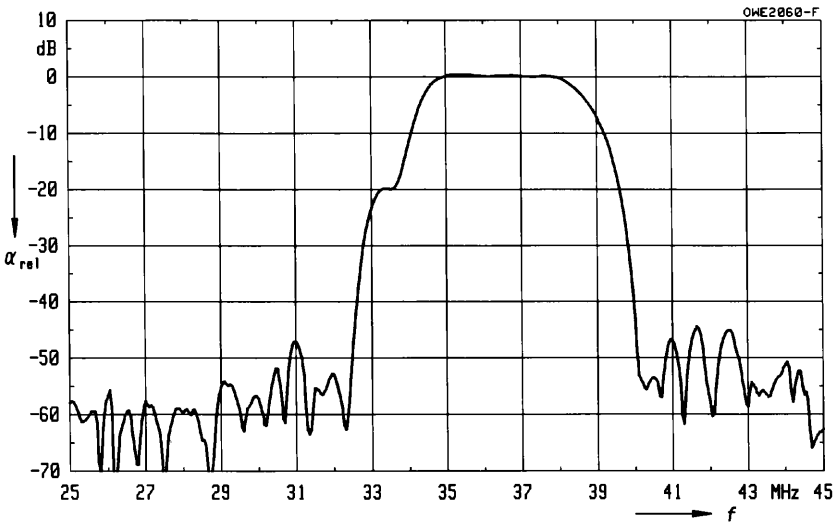
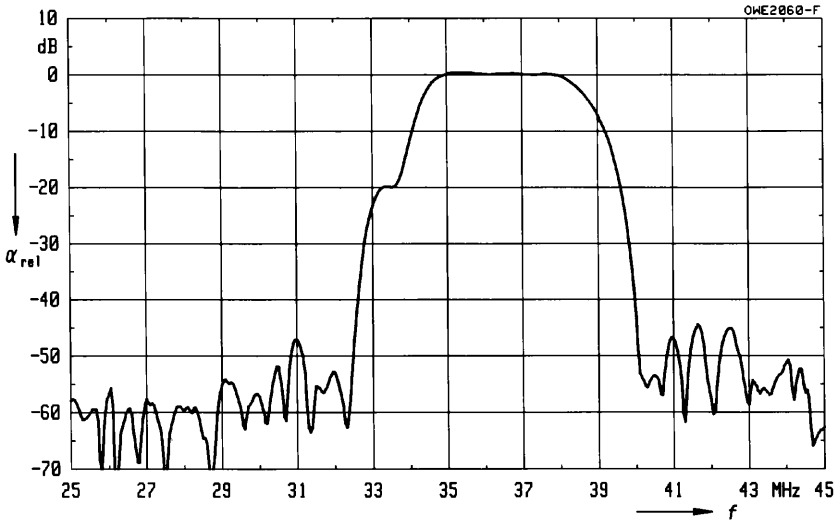

Standard

- B/G-CCIR
Germany, Europe partly

Features

- TV IF filter with Nyquist slope and sound shelf
- High color carrier level
- Constant group delay
- Suitable for CENELEC EN 55020

Terminals

- Tinned CuFe alloy

Plastic package **SIP 5 K**

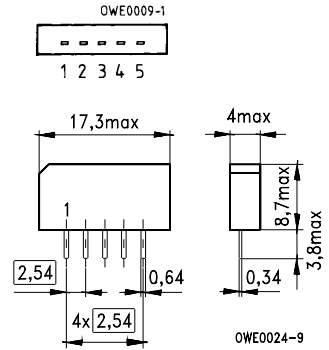

Dimensions in mm, approx. weight 1,0 g

Pin configuration

- 1 Input
- 2 Input – ground
- 3 Chip carrier – ground
- 4 Output
- 5 Output

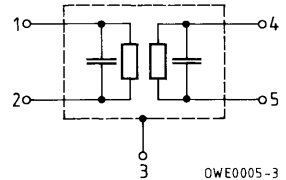

Type	Ordering code	Marking
G 1965 M	B39389-G1965-M100	Type, date code, pin 1

Maximum ratings

Ambient temperature	T_A	- 25/+ 65	°C	—
Storage temperature	T_{stg}	- 25/+ 85	°C	—
DC voltage	V_{DC}	12	V	between any terminals
AC voltage	V_{pp}	10	V	between any terminals

Characteristics

Ambient temperature $T_A = 25\text{ °C}$
 Source impedance $Z_S = 50\ \Omega$
 Load impedance $Z_L = 2\text{ k}\Omega \parallel 3\text{ pF}$

		min.	typ.	max.		
Insertion attenuation						
Reference level for the following data	37,40 MHz	α	13,5	15,0	16,5	dB
Relative attenuation						
Picture carrier	38,90 MHz	α_{rel}	5,0	6,0	7,0	dB
Color carrier	34,47 MHz		0,0	1,0	2,0	dB
Sound carrier	33,40 MHz		18,9	20,4	21,9	dB
Adjacent picture carrier	UHF 30,90 MHz		45,0	57,0	—	dB
	VHF 31,90 MHz		48,0	55,0	—	dB
	31,40 MHz		46,0	61,0	—	dB
	32,40 MHz		48,0	55,0	—	dB
	40,15 MHz		38,0	48,0	—	dB
Adjacent sound carrier	VHF 40,40 MHz		44,0	55,0	—	dB
	UHF 41,40 MHz		42,0	53,0	—	dB
Lower sidelobe	25,00 ... 31,90 MHz		40,0	47,0	—	dB
Upper sidelobe	40,40 ... 45,00 MHz		38,0	48,0	—	dB
Reflected wave signal suppression						
1,1 μ s ... 6,0 μ s after main pulse (test pulse: 250 ns, carrier frequency: 37,40 MHz)			42,0	53,0	—	dB
Feedthrough signal suppression						
1,3 μ s ... 1,1 μ s before main pulse (test pulse: 250 ns, carrier frequency: 37,40 MHz)			50,0	56,0	—	dB
Group delay ripple (p-p)		$\Delta\tau$	—	50	—	ns
Impedance at 37,40 MHz						
Input: $Z_{IN} = R_{IN} \parallel C_{IN}$			—	1,9 \parallel 13,8	—	k Ω \parallel pF
Output: $Z_{OUT} = R_{OUT} \parallel C_{OUT}$			—	1,5 \parallel 4,8	—	k Ω \parallel pF
Temperature coefficient of frequency		TC_f	—	-72	—	ppm/K

Frequency response

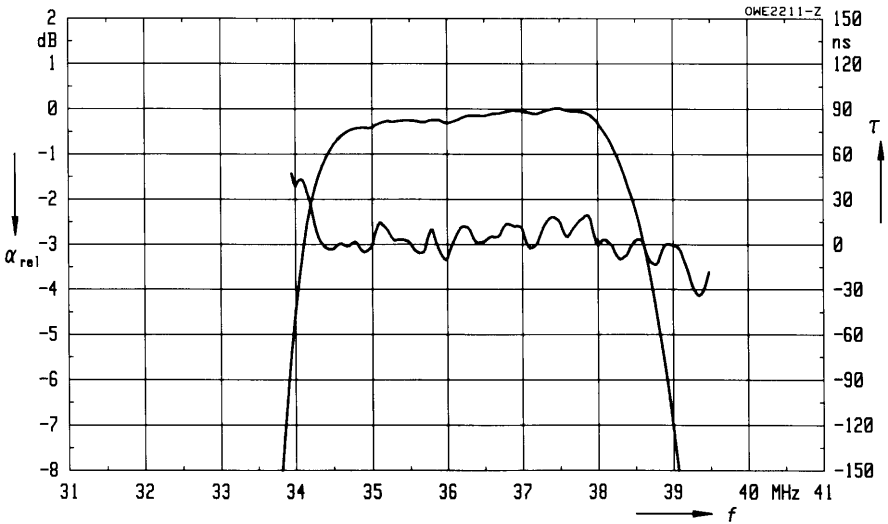
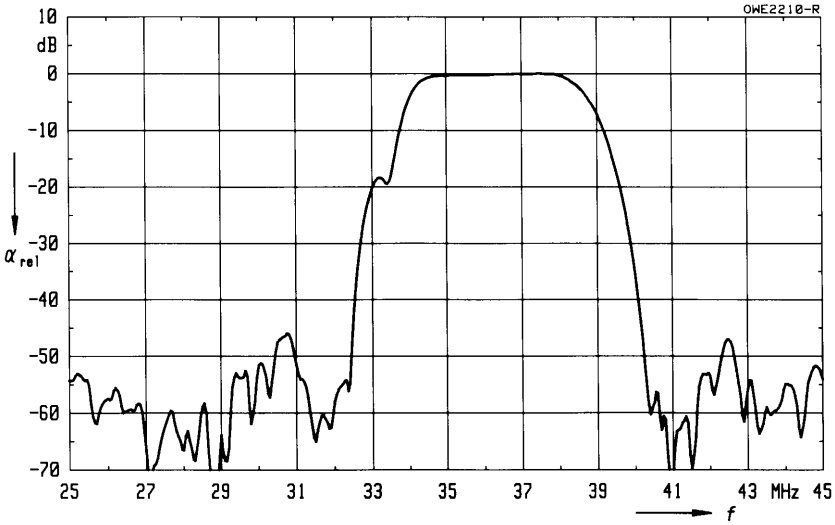

Standard

- B/G-CCIR
Germany, Europe partly

Features

- TV IF filter with Nyquist slope and sound shelf
- Highly reduced group delay predistortion as compared with standard B/G, half
- Optimized for CENELEC EN 55020

Terminals

- Tinned CuFe alloy

Plastic package **SIP 5 K**

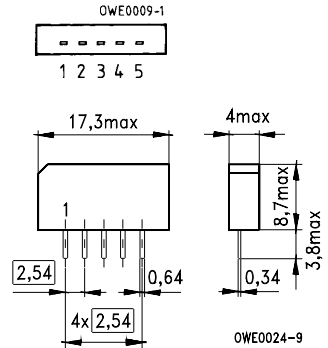

Dimensions in mm, approx. weight 1,0 g

Pin configuration

- 1 Input
- 2 Input – ground
- 3 Chip carrier – ground
- 4 Output
- 5 Output

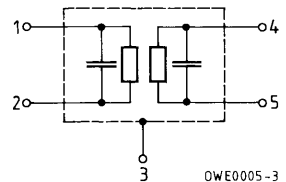

Type	Ordering code	Marking
G 1966 M	B39389-G1966-M100	Type, date code, pin 1

Maximum ratings

Ambient temperature	T_A	- 25/+ 65	°C	—
Storage temperature	T_{stg}	- 25/+ 85	°C	—
DC voltage	V_{DC}	12	V	between any terminals
AC voltage	V_{pp}	10	V	between any terminals

G 1966 M

38,90 MHz

Characteristics

Ambient temperature	$T_A = 25\text{ °C}$
Source impedance	$Z_S = 50\ \Omega$
Load impedance	$Z_L = 2\text{ k}\Omega \parallel 3\text{ pF}$

		min.	typ.	max.	
Insertion attenuation					
Reference level for the following data	37,40 MHz	13,8	15,3	16,8	dB
Relative attenuation					
Picture carrier	38,90 MHz	4,2	5,2	6,2	dB
Color carrier	34,47 MHz	1,8	2,8	3,8	dB
Sound carrier	33,40 MHz	17,6	18,6	19,6	dB
Adjacent picture carrier	UHF 30,90 MHz	46,0	60,0	—	dB
	VHF 31,90 MHz	46,0	52,0	—	dB
	32,40 MHz	46,0	56,0	—	dB
	40,15 MHz	46,0	55,0	—	dB
Adjacent sound carrier	VHF 40,40 MHz	38,0	44,0	—	dB
	UHF 41,40 MHz	48,0	58,0	—	dB
Lower sidelobe	25,00 ... 32,40 MHz	45,0	58,0	—	dB
Upper sidelobe	40,40 ... 45,00 MHz	38,0	44,0	—	dB
Reflected wave signal suppression					
1,3 μ s ... 6,0 μ s after main pulse (test pulse: 250 ns, carrier frequency: 37,40 MHz)		44,0	52,0	—	dB
Feedthrough signal suppression					
1,1 μ s ... 1,0 μ s before main pulse (test pulse: 250 ns, carrier frequency: 37,40 MHz)		50,0	56,0	—	dB
Group delay predistortion					
(reference frequency 38,90 MHz)					
	36,80 MHz	—	- 50	—	ns
	34,47 MHz	—	60	—	ns
Impedance at 37,40 MHz					
Input:	$Z_{IN} = R_{IN} \parallel C_{IN}$	—	1,1 \parallel 22,9	—	k Ω \parallel pF
Output:	$Z_{OUT} = R_{OUT} \parallel C_{OUT}$	—	1,3 \parallel 8,5	—	k Ω \parallel pF
Temperature coefficient of frequency					
	TC_f	—	- 72	—	ppm/K

Frequency response

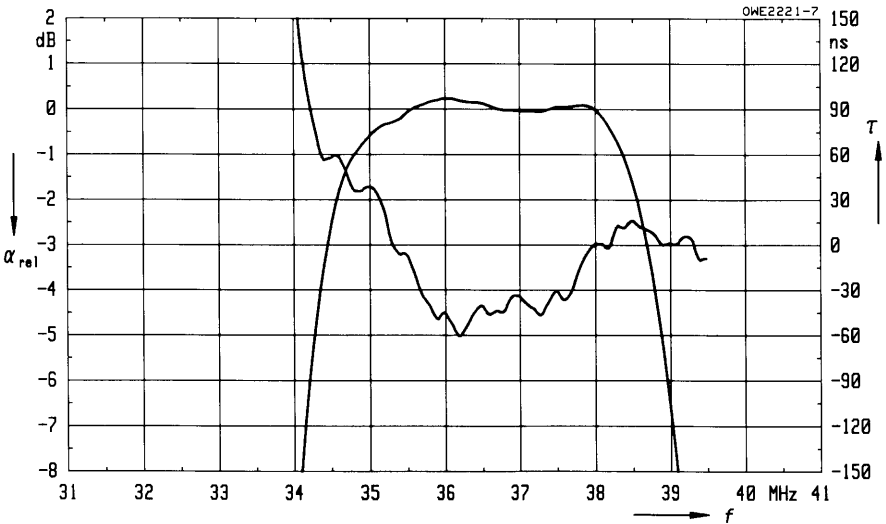
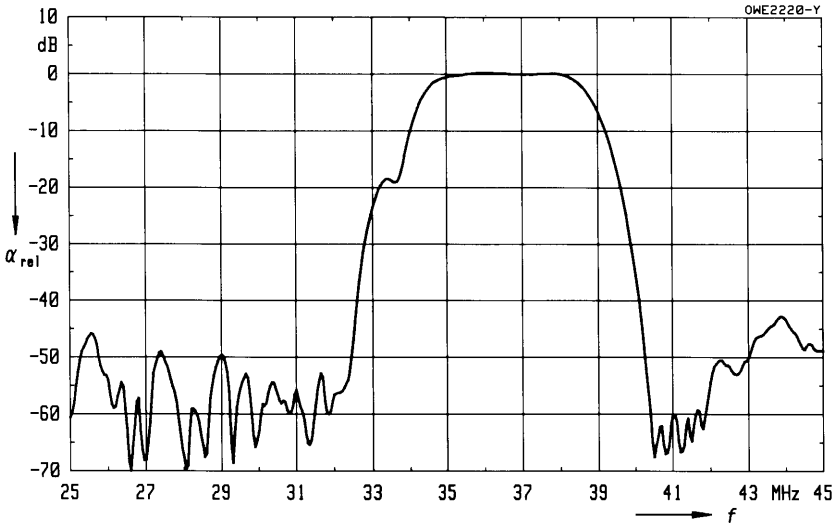

Standard

- B/G-CCIR
Germany, Europe partly

Features

- TV IF filter with Nyquist slope and sound shelf
- Group delay predistortion according standard B/G, half
- Optimized for CENELEC EN 55020

Terminals

- Tinned CuFe alloy

Plastic package **SIP 5 K**

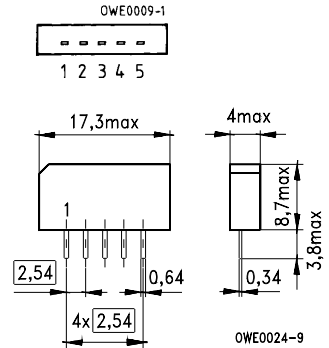

Dimensions in mm, approx. weight 1,0 g

Pin configuration

- 1 Input
- 2 Input – ground
- 3 Chip carrier – ground
- 4 Output
- 5 Output

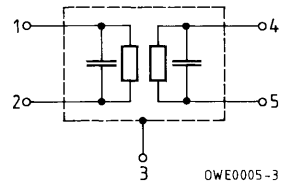

Type	Ordering code	Marking
G 1968 M	B39389-G1968-M100	Type, date code, pin 1

Maximum ratings

Ambient temperature	T_A	- 25/+ 65	°C	—
Storage temperature	T_{stg}	- 25/+ 85	°C	—
DC voltage	V_{DC}	12	V	between any terminals
AC voltage	V_{pp}	10	V	between any terminals

Characteristics

Ambient temperature $T_A = 25\text{ }^\circ\text{C}$
 Source impedance $Z_S = 50\ \Omega$
 Load impedance $Z_L = 2\ \text{k}\Omega \parallel 3\ \text{pF}$

		min.	typ.	max.	
Insertion attenuation					
Reference level for the following data	37,40 MHz	α 13,5	15,1	16,5	dB
Relative attenuation					
Picture carrier	38,90 MHz	α_{rel} 4,6	5,6	6,6	dB
Color carrier	34,47 MHz	2,7	3,7	4,7	dB
Sound carrier	33,40 MHz	18,4	19,9	21,4	dB
Adjacent picture carrier	UHF 30,90 MHz	48,0	60,0	—	dB
	VHF 31,90 MHz	48,0	59,0	—	dB
	32,40 MHz	48,0	61,0	—	dB
	40,15 MHz	48,0	58,0	—	dB
Adjacent sound carrier	VHF 40,40 MHz	42,0	51,0	—	dB
	UHF 41,40 MHz	48,0	58,0	—	dB
Lower sidelobe	25,00 ... 32,40 MHz	44,0	55,0	—	dB
Upper sidelobe	40,40 ... 45,00 MHz	40,0	44,0	—	dB
		38,0	47,0	—	dB
Reflected wave signal suppression					
1,2 μs ... 6,0 μs after main pulse (test pulse: 250 ns, carrier frequency: 37,40 MHz)		44,0	50,0	—	dB
Feedthrough signal suppression					
1,3 μs ... 1,1 μs before main pulse (test pulse: 250 ns, carrier frequency: 37,40 MHz)		50,0	56,0	—	dB
Group delay predistortion					
(reference frequency 38,90 MHz)		$\Delta\tau$			
	36,90 MHz	—	- 90	—	ns
	34,47 MHz	—	165	—	ns
Impedance at 37,40 MHz					
Input:	$Z_{\text{IN}} = R_{\text{IN}} \parallel C_{\text{IN}}$	—	1,7 \parallel 13,7	—	$\text{k}\Omega \parallel \text{pF}$
Output:	$Z_{\text{OUT}} = R_{\text{OUT}} \parallel C_{\text{OUT}}$	—	1,6 \parallel 4,8	—	$\text{k}\Omega \parallel \text{pF}$
Temperature coefficient of frequency					
	TC_f	—	- 72	—	ppm/K

Frequency response

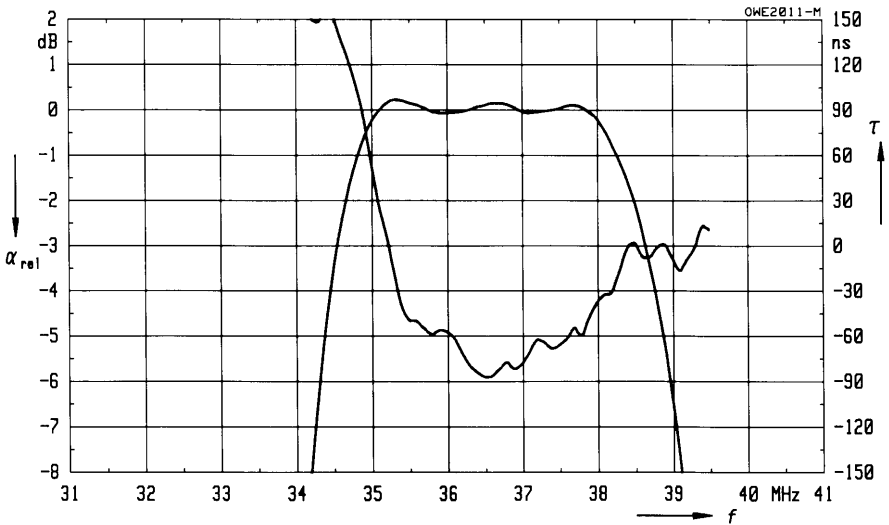
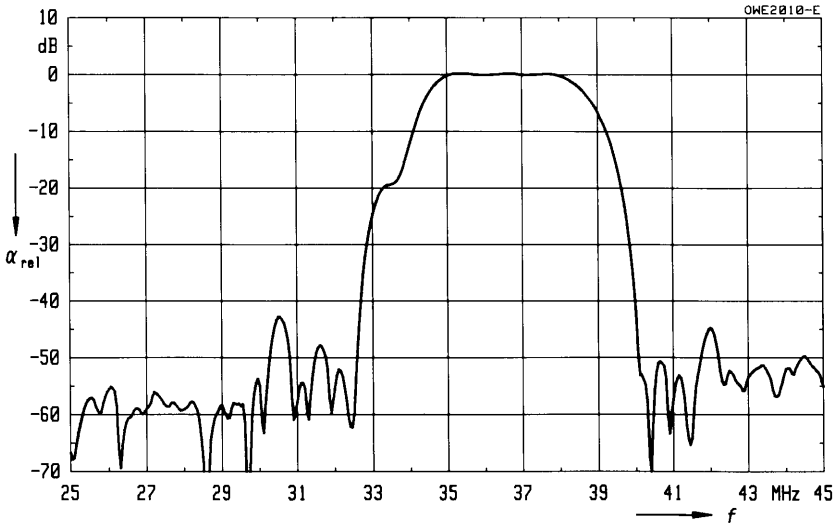

Standard

- I
Great Britain

Features

- TV IF filter with Nyquist slope and sound shelf
- Constant group delay
- Suitable for CENELEC EN 55020

Terminals

- Tinned CuFe alloy

Plastic package **SIP 5 K**

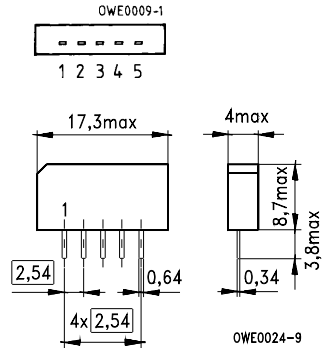

Dimensions in mm, approx. weight 1,0 g

Pin configuration

- 1 Input
- 2 Input – ground
- 3 Chip carrier – ground
- 4 Output
- 5 Output

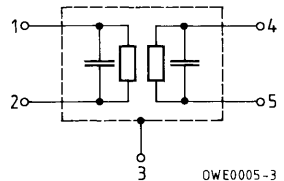

Type	Ordering code	Marking
J 1952 M	B39389-J1952-M100	Type, date code, pin 1

Maximum ratings

Ambient temperature	T_A	- 25/+ 65	°C	—
Storage temperature	T_{stg}	- 25/+ 85	°C	—
DC voltage	V_{DC}	12	V	between any terminals
AC voltage	V_{pp}	10	V	between any terminals

J 1952 M

38,90 MHz

Characteristics

Ambient temperature $T_A = 25\text{ °C}$
 Source impedance $Z_S = 50\ \Omega$
 Load impedance $Z_L = 2\text{ k}\Omega \parallel 3\text{ pF}$

		min.	typ.	max.	
Insertion attenuation					
Reference level for the following data	37,00 MHz	14,0	15,6	17,0	dB
Relative attenuation					
Picture carrier	38,90 MHz	5,5	6,5	7,5	dB
Color carrier	34,47 MHz	1,2	2,2	3,2	dB
Sound carrier	32,90 MHz	19,4	20,4	21,4	dB
Adjacent picture carrier	30,90 MHz	46,0	56,0	—	dB
	30,40 MHz	45,0	56,0	—	dB
	31,40 MHz	42,0	52,0	—	dB
Adjacent sound carrier	40,90 MHz	44,0	53,0	—	dB
Lower sidelobe	25,00 ... 30,90 MHz	42,0	50,0	—	dB
Upper sidelobe	40,90 ... 45,00 MHz	38,0	44,0	—	dB
Reflected wave signal suppression					
1,3 μ s ... 6,0 μ s after main pulse (test pulse: 250 ns, carrier frequency: 37,00 MHz)		42,0	50,0	—	dB
Feedthrough signal suppression					
1,1 μ s ... 0,9 μ s before main pulse (test pulse: 250 ns, carrier frequency: 37,00 MHz)		50,0	56,0	—	dB
Group delay ripple (p-p)	$\Delta\tau$	—	40	—	ns
Impedance at 37,00 MHz					
Input: $Z_{IN} = R_{IN} \parallel C_{IN}$		—	2,3 \parallel 10,0	—	k Ω \parallel pF
Output: $Z_{OUT} = R_{OUT} \parallel C_{OUT}$		—	1,9 \parallel 5,2	—	k Ω \parallel pF
Temperature coefficient of frequency	TC_f	—	-72	—	ppm/K

Frequency response

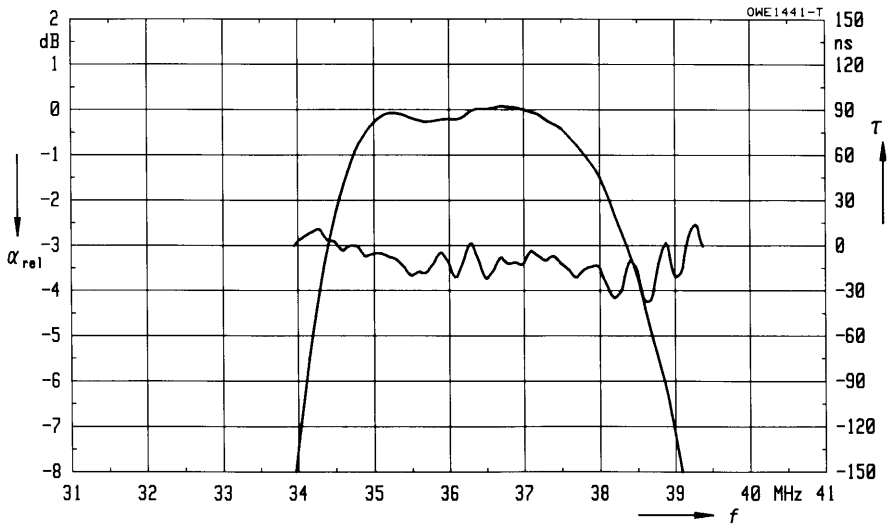
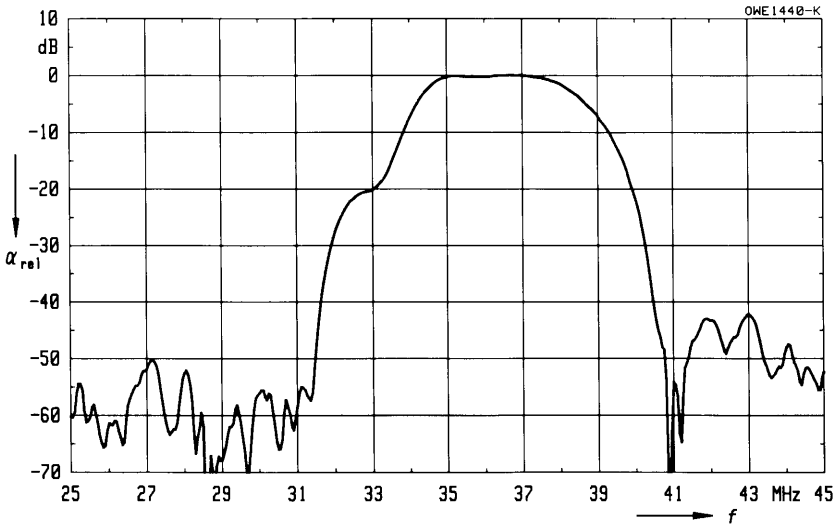

Standard

- I
Great Britain

Features

- TV IF filter with Nyquist slope and sound shelf
- Broad sound shelf at 14 dB level for sound carriers at 32,90 MHz and 32,35 MHz (NICAM)
- Constant group delay
- Suitable for CENELEC EN 55020

Terminals

- Tinned CuFe alloy

Plastic package **SIP 5 K**

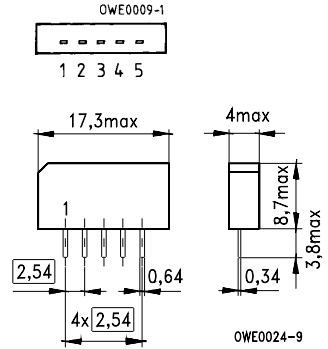

Dimensions in mm, approx. weight 1,0 g

Pin configuration

- 1 Input
- 2 Input – ground
- 3 Chip carrier – ground
- 4 Output
- 5 Output

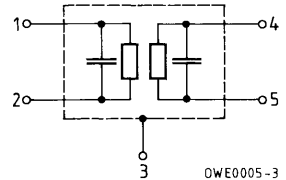

Type	Ordering code	Marking
J 1980 M	B39389-J1980-M100	Type, date code, pin 1

Maximum ratings

Ambient temperature	T_A	- 25/+ 65	°C	—
Storage temperature	T_{stg}	- 25/+ 85	°C	—
DC voltage	V_{DC}	12	V	between any terminals
AC voltage	V_{pp}	10	V	between any terminals

Characteristics

Ambient temperature $T_A = 25\text{ }^\circ\text{C}$
 Source impedance $Z_S = 50\ \Omega$
 Load impedance $Z_L = 2\ \text{k}\Omega \parallel 3\ \text{pF}$

		min.	typ.	max.		
Insertion attenuation						
Reference level for the following data	37,00 MHz	α	14,0	15,5	17,0	dB
Relative attenuation						
Picture carrier	38,90 MHz	α_{rel}	5,2	6,2	7,2	dB
Color carrier	34,47 MHz		-0,8	0,2	1,2	dB
Sound carrier	32,90 MHz		12,8	13,8	14,8	dB
	32,35 MHz		12,8	13,8	—	dB
Adjacent picture carrier	30,90 MHz		46,0	54,0	—	dB
Adjacent sound carrier	40,90 MHz		44,0	53,0	—	dB
	40,35 MHz		40,0	46,0	—	dB
Lower sidelobe	25,00 ... 30,90 MHz		44,0	52,0	—	dB
Upper sidelobe	40,90 ... 45,00 MHz		40,0	48,0	—	dB
Reflected wave signal suppression						
1,2 μs ... 6,0 μs after main pulse (test pulse: 250 ns, carrier frequency: 37,00 MHz)			42,0	56,0	—	dB
Feedthrough signal suppression						
1,2 μs ... 1,1 μs before main pulse (test pulse: 250 ns, carrier frequency: 37,00 MHz)			50,0	56,0	—	dB
Group delay ripple (p-p)		$\Delta\tau$	—	30	—	ns
Impedance at 37,00 MHz						
Input: $Z_{\text{IN}} = R_{\text{IN}} \parallel C_{\text{IN}}$			—	1,6 \parallel 14,4	—	$\text{k}\Omega \parallel \text{pF}$
Output: $Z_{\text{OUT}} = R_{\text{OUT}} \parallel C_{\text{OUT}}$			—	2,0 \parallel 3,8	—	$\text{k}\Omega \parallel \text{pF}$
Temperature coefficient of frequency		TC_f	—	-72	—	ppm/K

Frequency response

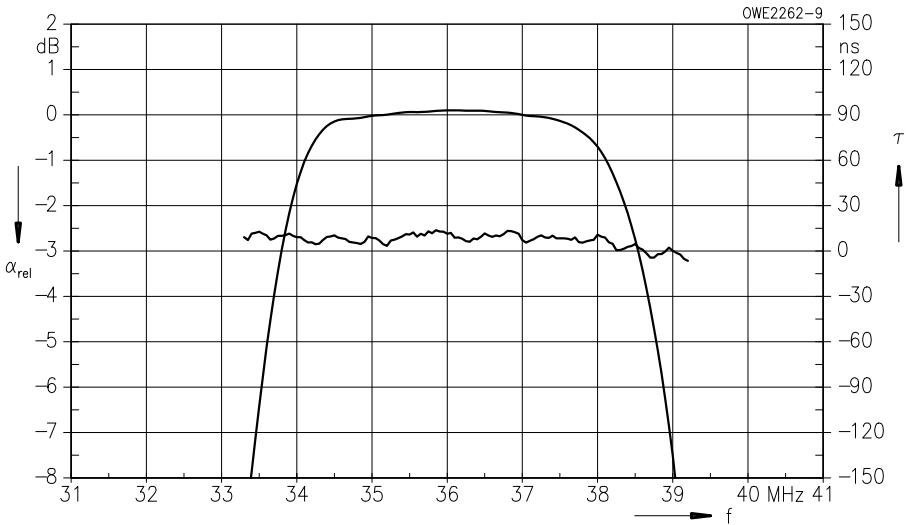
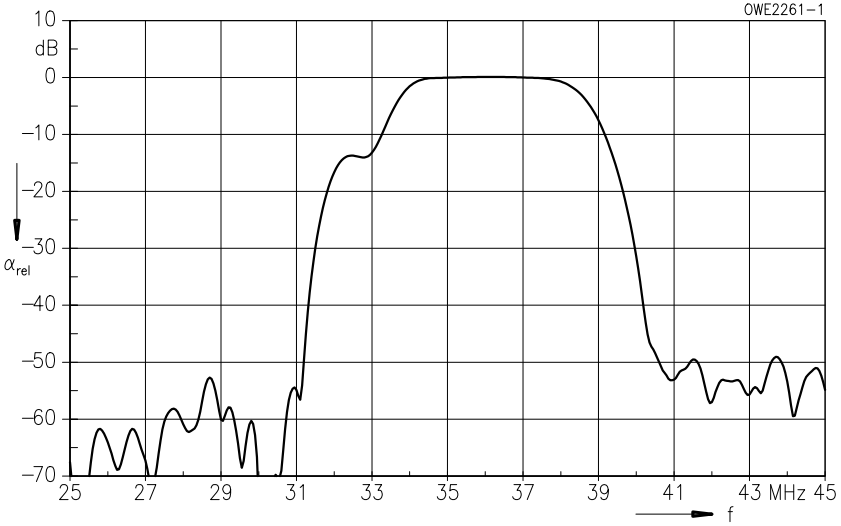

Standard

- D/K-OIRT
Eastern standard
- B/G-CCIR
Europe partly

Features

- TV IF filter with Nyquist slope and sound shelf
- Broad sound shelf for sound carriers at 32,40 MHz and 33,40 MHz
- Customized group delay predistortion

Terminals

- Tinned CuFe alloy

Plastic package **SIP 5 K**

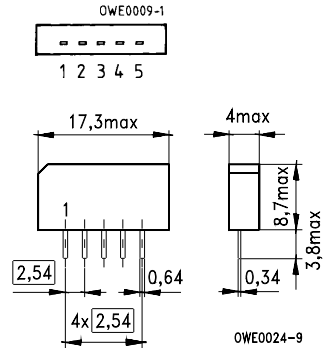

Dimensions in mm, approx. weight 1,0 g

Pin configuration

- 1 Input
- 2 Input – ground
- 3 Chip carrier – ground
- 4 Output
- 5 Output

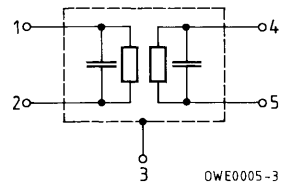

Type	Ordering code	Marking
K 2955 M	B39389-K2955-M100	Type, date code, pin 1

Maximum ratings

Ambient temperature	T_A	- 25/+ 65	°C	—
Storage temperature	T_{stg}	- 25/+ 85	°C	—
DC voltage	V_{DC}	12	V	between any terminals
AC voltage	V_{pp}	10	V	between any terminals

K 2955 M

38,90 MHz

Characteristics

Ambient temperature	$T_A = 25\text{ °C}$
Source impedance	$Z_S = 50\ \Omega$
Load impedance	$Z_L = 2\text{ k}\Omega \parallel 3\text{ pF}$

		min.	typ.	max.		
Insertion attenuation						
Reference level for the following data	37,40 MHz	α	16,1	17,6	19,1	dB
Relative attenuation						
Picture carrier	38,90 MHz	α_{rel}	4,7	5,7	6,7	dB
Color carrier	34,47 MHz		2,8	3,8	4,8	dB
Sound carrier	32,40 MHz		18,8	20,3	21,8	dB
	33,40 MHz		19,4	20,9	—	dB
Adjacent picture carrier	30,90 MHz		48,0	66,0	—	dB
Adjacent sound carrier	40,40 MHz		43,0	56,0	—	dB
	41,40 MHz		42,0	52,0	—	dB
Lower sidelobe	25,00 ... 30,90 MHz		40,0	51,0	—	dB
Upper sidelobe	40,40 ... 45,00 MHz		36,0	42,0	—	dB
Reflected wave signal suppression						
1,2 μ s ... 6,0 μ s after main pulse (test pulse: 250 ns, carrier frequency: 37,40 MHz)			42,0	54,0	—	dB
Feedthrough signal suppression						
1,2 μ s ... 1,1 μ s before main pulse (test pulse: 250 ns, carrier frequency: 37,40 MHz)			50,0	56,0	—	dB
Group delay pre-distortion						
(reference frequency 38,90 MHz)		$\Delta\tau$				
	36,50 MHz		—	-65	—	ns
	34,47 MHz		—	0	—	ns
Impedance at 37,40 MHz						
Input: $Z_{IN} = R_{IN} \parallel C_{IN}$			—	2,2 \parallel 10,7	—	$\text{k}\Omega \parallel \text{pF}$
Output: $Z_{OUT} = R_{OUT} \parallel C_{OUT}$			—	3,1 \parallel 2,8	—	$\text{k}\Omega \parallel \text{pF}$
Temperature coefficient of frequency						
		TC_f	—	-72	—	ppm/K

Frequency response

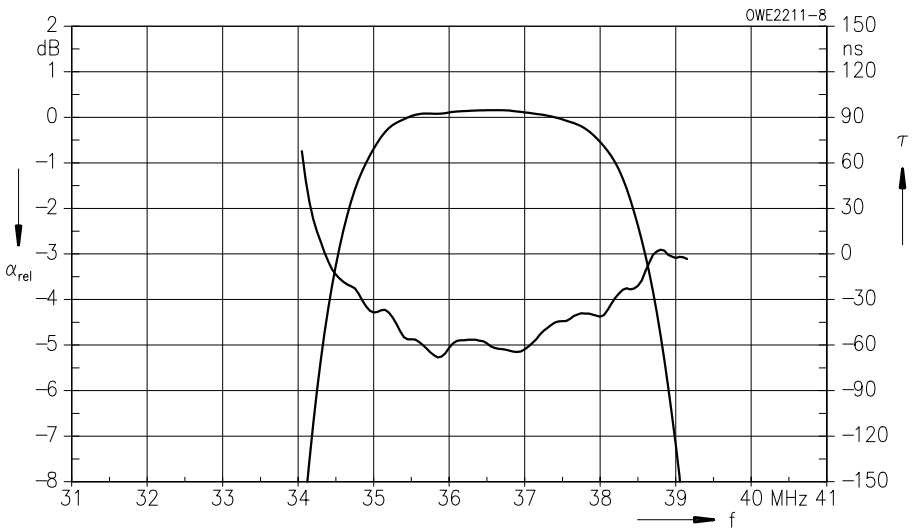
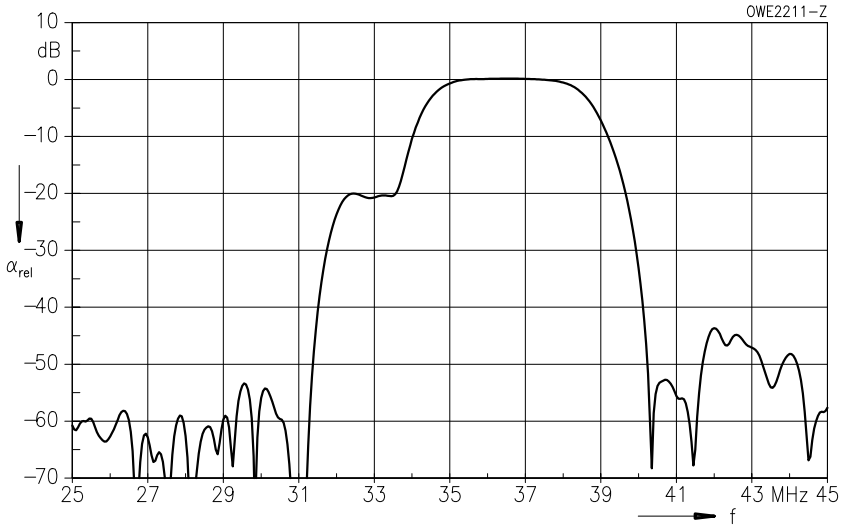

Standard

- B/G-CCIR
Germany, Europe partly
- D/K-OIRT
Eastern standard
- I
Great Britain
- L/L'
France

Features

- TV IF filter with two Nyquist slopes and sound shelf
- Picture carriers at 33,90 MHz and 38,90 MHz
- Broad sound shelf at 15 dB level for sound carriers at 32,90 MHz and 33,40 MHz
- Constant group delay

Terminals

- Tinned CuFe alloy

Pin configuration

- 1 Input
- 2 Input – ground
- 3 Chip carrier – ground
- 4 Output
- 5 Output

Plastic package **SIP 5 K**

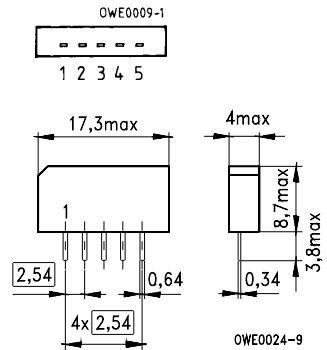

Dimensions in mm, approx. weight 1,0 g

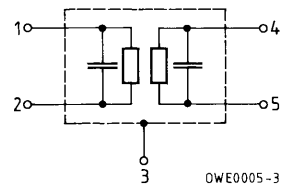

Type	Ordering code	Marking
K 2962 M	B39389-K2962-M100	Type, date code, pin 1

Maximum ratings

Ambient temperature	T_A	- 25/+ 65	°C	—
Storage temperature	T_{stg}	- 25/+ 85	°C	—
DC voltage	V_{DC}	12	V	between any terminals
AC voltage	V_{pp}	10	V	between any terminals

Characteristics

Ambient temperature $T_A = 25\text{ °C}$
 Source impedance $Z_S = 50\ \Omega$
 Load impedance $Z_L = 2\text{ k}\Omega \parallel 3\text{ pF}$

		min.	typ.	max.	
Insertion attenuation					
Reference level for the following data	37,40 MHz	13,4	14,9	16,4	dB
Relative attenuation					
Picture carrier	38,90 MHz	4,6	5,6	6,6	dB
	33,90 MHz	5,8	6,8	7,8	dB
Color carrier	34,47 MHz	0,0	1,0	2,0	dB
Sound carrier	33,40 MHz	—	14,8	—	dB
	32,90 MHz	—	14,9	—	dB
Adjacent picture carrier	31,90 MHz	44,0	56,0	—	dB
Adjacent sound carrier	40,40 MHz	42,0	50,0	—	dB
Lower sidelobe	25,00 ... 31,90 MHz	40,0	47,0	—	dB
Upper sidelobe	40,40 ... 45,00 MHz	40,0	47,0	—	dB
Reflected wave signal suppression					
1,2 μ s ... 6,0 μ s after main pulse (test pulse: 250 ns, carrier frequency: 37,40 MHz)		42,0	54,0	—	dB
Feedthrough signal suppression					
1,2 μ s ... 1,1 μ s before main pulse (test pulse: 250 ns, carrier frequency: 37,40 MHz)		50,0	56,0	—	dB
Group delay ripple (p-p)	$\Delta\tau$	—	40	—	ns
Impedance at 37,40 MHz					
Input: $Z_{IN} = R_{IN} \parallel C_{IN}$		—	1,5 \parallel 15,1	—	k Ω \parallel pF
Output: $Z_{OUT} = R_{OUT} \parallel C_{OUT}$		—	1,8 \parallel 3,9	—	k Ω \parallel pF
Temperature coefficient of frequency	TC_f	—	-72	—	ppm/K

Frequency response

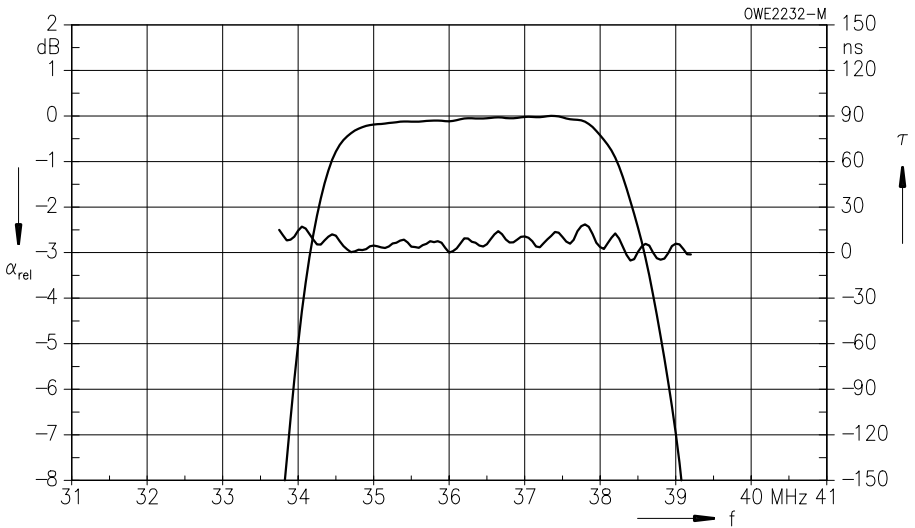
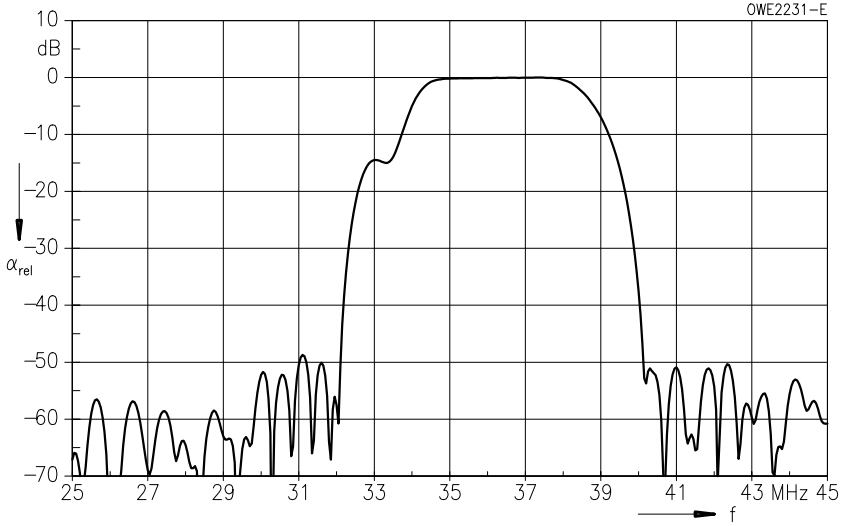

Standard

- B/G-CCIR
Germany, Europe partly
- D/K-OIRT
Eastern standard

Plastic package DIP 10 K

Features

- TV IF filter switchable from B/G mode to D/K mode
- B/G mode with Nyquist slope and sound shelf at 33,40 MHz
- Highly reduced group delay predistortion as compared with standard B/G half
- D/K mode with Nyquist slope and sound shelf at 32,40 MHz
- Customized group delay predistortion
- Suitable for CENELEC EN 55020

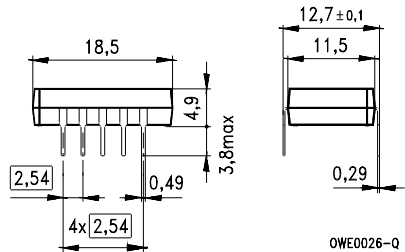
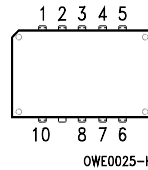

Terminals

- Tinned CuFe alloy

Dimensions in mm, approx. weight 1,8 g

Pin configuration

- 1 Input
- 2 Input – ground
- 3, 8 Chip carrier – ground
- 4, 5 Output
- 6, 7 Not connected
- 9 Free
- 10 Switching input

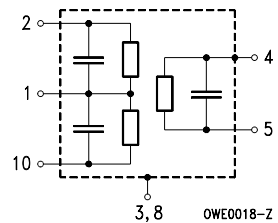

Type	Ordering code	Marking
K 6255 K	B39389-K6255-K100	Type, date code, pin 1

Maximum ratings

Ambient temperature	T_A	- 25/+ 65	°C	—
Storage temperature	T_{stg}	- 25/+ 85	°C	—
DC voltage	V_{DC}	12	V	between any terminals
AC voltage	V_{pp}	10	V	between any terminals

K 6255 K

38,90 MHz

Characteristics in B/G mode (switching input pin 10 connected to input pin 1)

Ambient temperature $T_A = 25\text{ °C}$
 Source impedance $Z_S = 50\ \Omega$
 Load impedance $Z_L = 2\text{ k}\Omega \parallel 3\text{ pF}$

		min.	typ.	max.	
Insertion attenuation					
Reference level for the following data	37,40 MHz	α 15,5	16,9	18,5	dB
Relative attenuation					
Picture carrier	38,90 MHz	α_{rel} 4,0	5,0	6,0	dB
Color carrier	34,47 MHz	2,1	3,1	4,1	dB
Sound carrier	33,40 MHz	17,8	19,3	20,8	dB
Adjacent picture carrier	UHF 30,90 MHz	44,0	50,0	—	dB
	VHF 31,90 MHz	44,0	50,0	—	dB
Adjacent sound carrier	40,15 MHz	44,0	50,0	—	dB
	VHF 40,40 MHz	37,0	42,0	—	dB
	UHF 41,40 MHz	45,0	56,0	—	dB
Lower sidelobe	25,00 ... 31,90 MHz	42,0	52,0	—	dB
Upper sidelobe	40,40 ... 45,00 MHz	38,0	45,0	—	dB
Reflected wave signal suppression					
1,2 μ s ... 6,0 μ s after main pulse (test pulse: 250 ns, carrier frequency: 37,40 MHz)		43,0	50,0	—	dB
Feedthrough signal suppression					
1,2 μ s ... 1,1 μ s before main pulse (test pulse: 250 ns, carrier frequency: 37,40 MHz)		—	56,0	—	dB
Group delay predistortion					
(reference frequency 38,90 MHz)		$\Delta\tau$			
	36,60 MHz	—	- 60	—	ns
	34,47 MHz	—	20	—	ns
Impedance at 37,40 MHz					
Input: $Z_{IN} = R_{IN} \parallel C_{IN}$		—	1,1 \parallel 17,4	—	k Ω \parallel pF
Output: $Z_{OUT} = R_{OUT} \parallel C_{OUT}$		—	1,4 \parallel 5,8	—	k Ω \parallel pF
Temperature coefficient of frequency					
		TC_f	—	- 72	ppm/K

Frequency response (B/G mode)

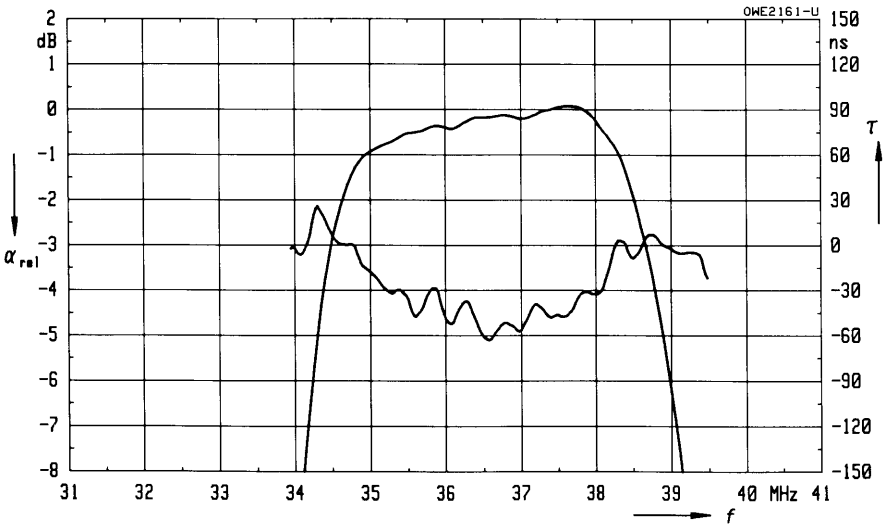
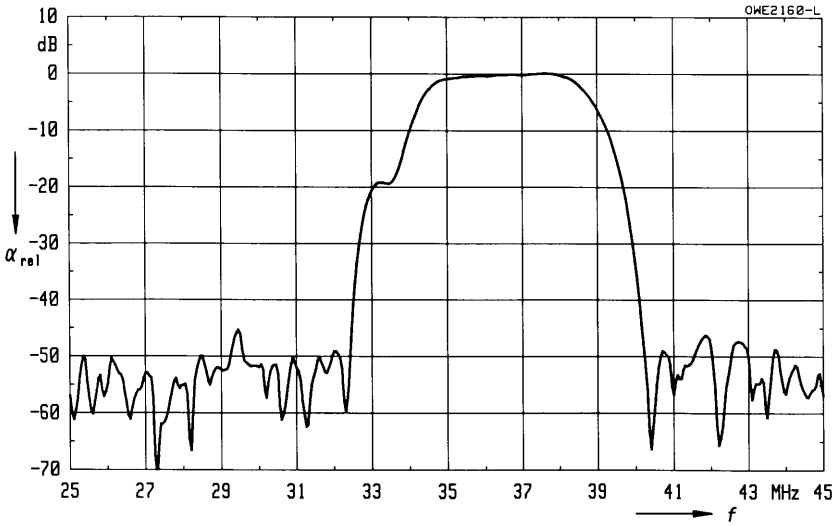

K 6255 K

38,90 MHz

Characteristics in D/K mode (switching input pin 10 connected to ground input pin 2)

Ambient temperature $T_A = 25\text{ °C}$
 Source impedance $Z_S = 50\ \Omega$
 Load impedance $Z_L = 2\text{ k}\Omega \parallel 3\text{ pF}$

		min.	typ.	max.	
Insertion attenuation					
Reference level for the following data	37,40 MHz	15,5	16,8	18,5	dB
Relative attenuation					
Picture carrier	38,90 MHz	4,1	5,1	6,1	dB
Color carrier	34,47 MHz	-0,2	0,8	1,8	dB
Sound carrier	32,40 MHz	18,7	20,2	21,7	dB
Adjacent picture carrier	30,90 MHz	44,0	53,0	—	dB
Adjacent sound carrier	40,40 MHz	44,0	56,0	—	dB
Lower sidelobe	25,00 ... 30,90 MHz	38,0	47,0	—	dB
Upper sidelobe	40,40 ... 45,00 MHz	36,0	43,0	—	dB
Reflected wave signal suppression					
1,2 μ s ... 6,0 μ s after main pulse (test pulse: 250 ns, carrier frequency: 37,40 MHz)		43,0	50,0	—	dB
Feedthrough signal suppression					
1,2 μ s ... 1,1 μ s before main pulse (test pulse: 250 ns, carrier frequency: 37,40 MHz)		—	56,0	—	dB
Group delay predistortion					
(reference frequency 38,90 MHz)					
	36,60 MHz	—	-50	—	ns
	34,47 MHz	—	20	—	ns
Impedance at 37,40 MHz					
Input: $Z_{IN} = R_{IN} \parallel C_{IN}$		—	0,9 \parallel 23,8	—	k Ω \parallel pF
Output: $Z_{OUT} = R_{OUT} \parallel C_{OUT}$		—	1,4 \parallel 5,8	—	k Ω \parallel pF
Temperature coefficient of frequency					
	TC_f	—	-72	—	ppm/K

Frequency response (D/K mode)

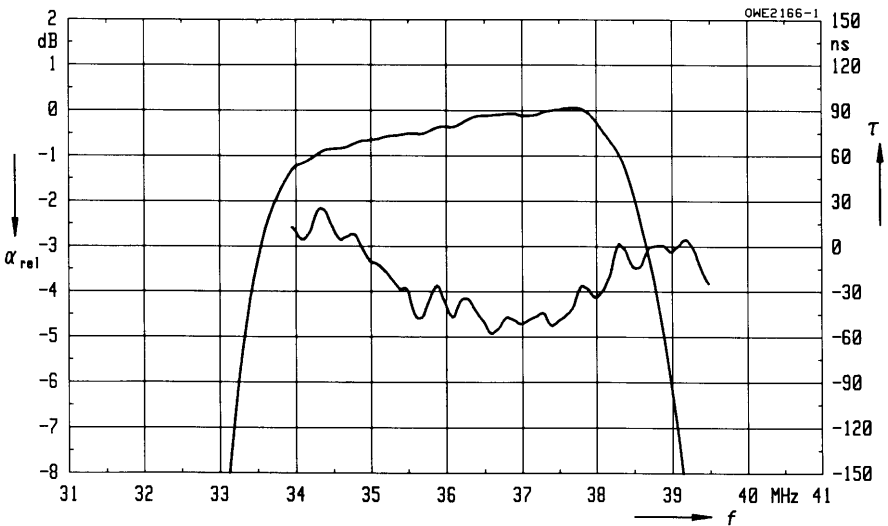
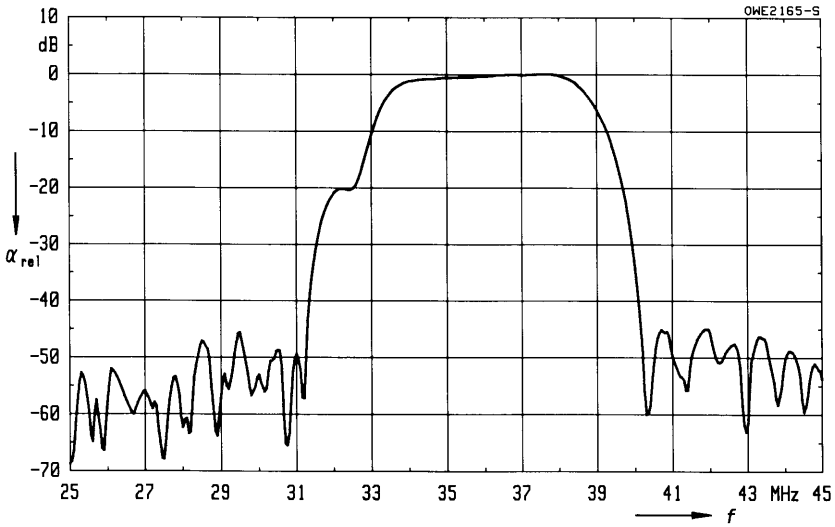

Standard

- B/G-CCIR
Germany, Europe partly
- D/K-OIRT
Eastern standard
- I
Great Britain
- L/L'
France

Plastic package **DIP 10 K**

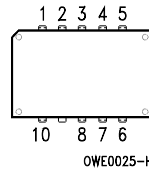

Features

- TV IF filter switchable from B/G mode to L/L' mode
- B/G mode with Nyquist slope and sound shelf at 33,40 MHz
- Reduced group delay predistortion as compared with standard B/G half
- L/L' mode with Nyquist slopes at 38,90 MHz and 33,90 MHz
- Constant group delay
- Suitable for CENELEC EN 55020

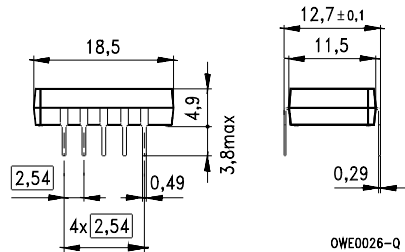

Dimensions in mm, approx. weight 1,8 g

Terminals

- Tinned CuFe alloy

Pin configuration

- 1 Input
- 2 Input – ground
- 3, 8 Chip carrier – ground
- 4, 5 Output
- 6, 7 Not connected
- 9 Free
- 10 Switching input

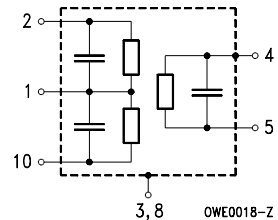

Type	Ordering code	Marking
K 6256 K	B39389-K6256-K100	Type, date code, pin 1

Maximum ratings

Ambient temperature	T_A	- 25/+ 65	°C	—
Storage temperature	T_{stg}	- 25/+ 85	°C	—
DC voltage	V_{DC}	12	V	between any terminals
AC voltage	V_{pp}	10	V	between any terminals

Characteristics in B/G mode (switching input pin 10 connected to ground input pin 2)

Ambient temperature $T_A = 25\text{ °C}$
 Source impedance $Z_S = 50\ \Omega$
 Load impedance $Z_L = 2\text{ k}\Omega \parallel 3\text{ pF}$

		min.	typ.	max.		
Insertion attenuation						
Reference level for the following data	37,40 MHz	α	15,5	17,0	18,5	dB
Relative attenuation						
Picture carrier	38,90 MHz	α_{rel}	4,5	5,5	6,5	dB
Color carrier	34,47 MHz		1,3	2,3	3,3	dB
Sound carrier	33,40 MHz		18,7	19,7	20,7	dB
Adjacent picture carrier	UHF 30,90 MHz		42,0	49,0	—	dB
	VHF 31,90 MHz		44,0	51,0	—	dB
	32,40 MHz		44,0	52,0	—	dB
	40,15 MHz		38,0	44,0	—	dB
Adjacent sound carrier	VHF 40,40 MHz		44,0	56,0	—	dB
Adjacent picture carrier	UHF 41,40 MHz		42,0	53,0	—	dB
Lower sidelobe	25,00 ... 31,90 MHz		40,0	46,0	—	dB
Upper sidelobe	40,40 ... 45,00 MHz		40,0	47,0	—	dB
Reflected wave signal suppression						
1,2 μ s ... 6,0 μ s after main pulse (test pulse: 250 ns, carrier frequency: 37,40 MHz)			42,0	50,0	—	dB
Feedthrough signal suppression						
1,2 μ s ... 1,1 μ s before main pulse (test pulse: 250 ns, carrier frequency: 37,40 MHz)			—	56,0	—	dB
Group delay predistortion						
(reference frequency 38,90 MHz)		$\Delta\tau$				
	36,80 MHz		—	- 65	—	ns
	34,47 MHz		—	30	—	ns
Impedance at 37,40 MHz						
Input: $Z_{IN} = R_{IN} \parallel C_{IN}$			—	1,0 \parallel 23,2	—	k Ω \parallel pF
Output: $Z_{OUT} = R_{OUT} \parallel C_{OUT}$			—	0,9 \parallel 6,5	—	k Ω \parallel pF
Temperature coefficient of frequency		TC_f	—	- 72	—	ppm/K

Frequency response (B/G mode)

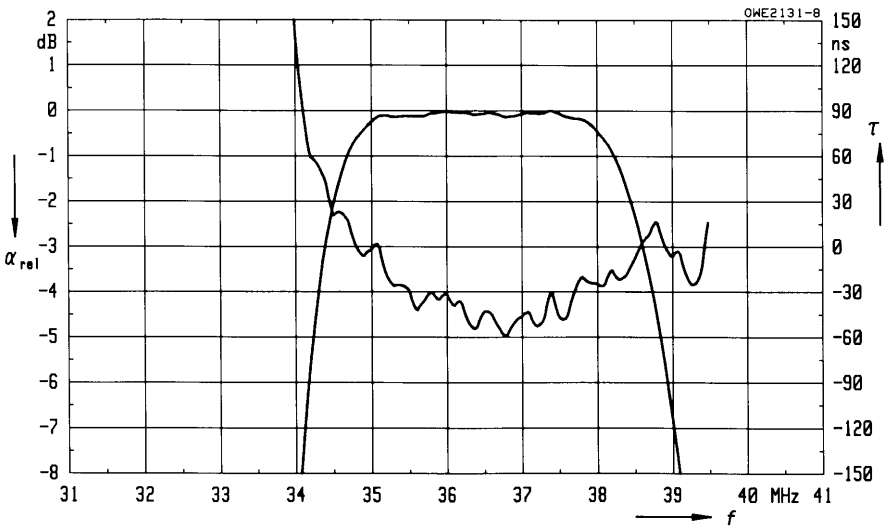
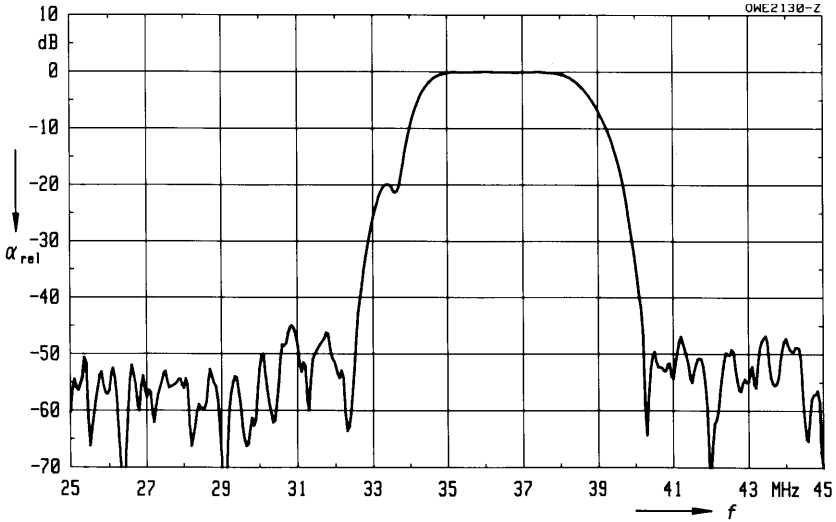

Characteristics in L/L' mode (switching input pin 10 connected to input pin 1)

Ambient temperature $T_A = 25\text{ °C}$
 Source impedance $Z_S = 50\ \Omega$
 Load impedance $Z_L = 2\text{ k}\Omega \parallel 3\text{ pF}$

		min.	typ.	max.	
Insertion attenuation					
Reference level for the following data	37,40 MHz	α 15,5	17,0	18,5	dB
Relative attenuation					
Picture carrier	38,90 MHz	α_{rel} 4,3	5,3	6,3	dB
	33,90 MHz	5,5	6,5	7,5	dB
	34,47 MHz	-0,2	0,8	1,8	dB
	30,90 MHz	42,0	47,0	—	dB
	32,40 MHz	46,0	53,0	—	dB
	32,90 MHz	—	56,0	—	dB
	40,40 MHz	42,0	53,0	—	dB
	40,90 MHz	—	49,0	—	dB
	41,90 MHz	43,0	54,0	—	dB
Lower sidelobe	25,00 ... 32,90 MHz	40,0	46,0	—	dB
Upper sidelobe	40,40 ... 45,00 MHz	40,0	46,0	—	dB
Reflected wave signal suppression					
1,2 μ s ... 6,0 μ s after main pulse (test pulse: 250 ns, carrier frequency: 37,40 MHz)		42,0	52,0	—	dB
Feedthrough signal suppression					
1,2 μ s ... 1,1 μ s before main pulse (test pulse: 250 ns, carrier frequency: 37,40 MHz)		—	56,0	—	dB
Group delay ripple (p-p)		$\Delta\tau$	40	—	ns
Impedance at 37,40 MHz					
Input: $Z_{IN} = R_{IN} \parallel C_{IN}$		—	1,6 \parallel 16,1	—	k Ω \parallel pF
Output: $Z_{OUT} = R_{OUT} \parallel C_{OUT}$		—	0,9 \parallel 6,5	—	k Ω \parallel pF
Temperature coefficient of frequency		TC_f	-72	—	ppm/K

K 6256 K
33,90/38,90 MHz

Frequency response (L/L' mode)

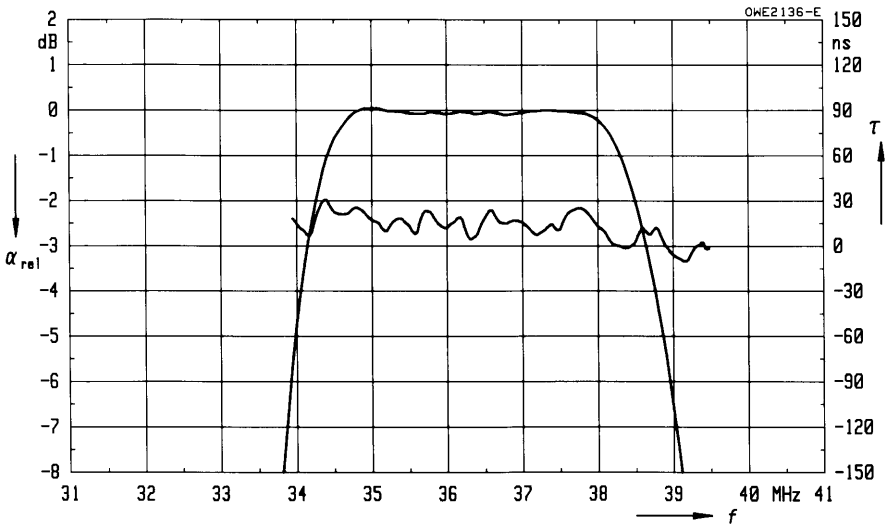
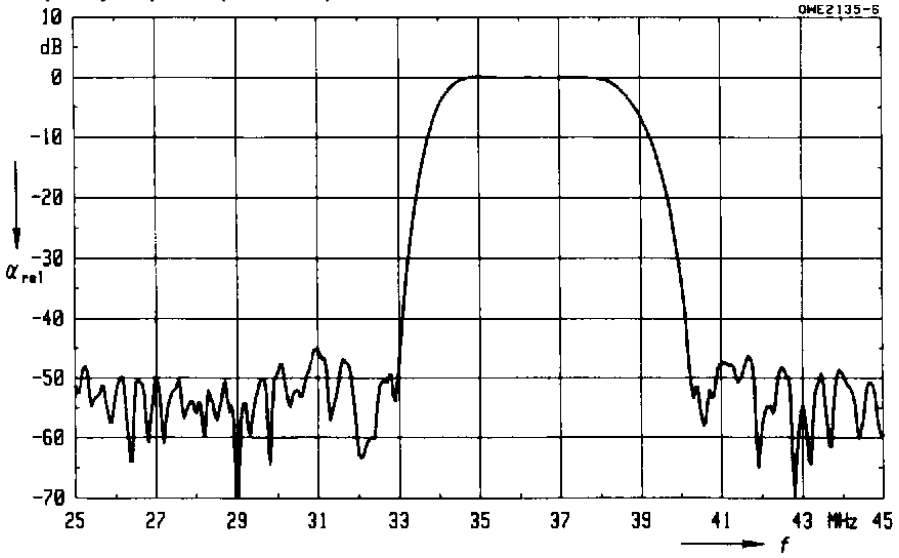

Standard

- I
Great Britain

Features

- TV IF filter with Nyquist slope and sound shelf
- Constant group delay
- Suitable for CENELEC EN 55020

Terminals

- Tinned CuFe alloy

Plastic package **SIP 5 K**

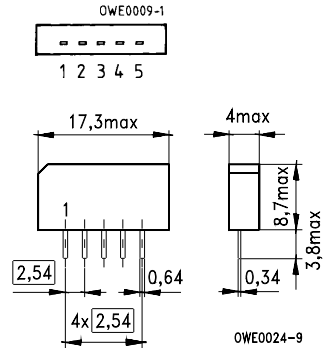

Dimensions in mm, approx. weight 1,0 g

Pin configuration

- 1 Input
- 2 Input – ground
- 3 Chip carrier – ground
- 4 Output
- 5 Output

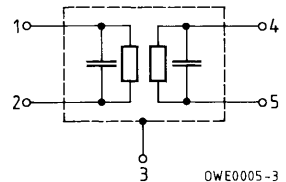

Type	Ordering code	Marking
J 1951 M	B39395-J1951-M100	Type, date code, pin 1

Maximum ratings

Ambient temperature	T_A	- 25/+ 65	°C	—
Storage temperature	T_{stg}	- 25/+ 85	°C	—
DC voltage	V_{DC}	12	V	between any terminals
AC voltage	V_{pp}	10	V	between any terminals

J 1951 M

39,50 MHz

Characteristics

Ambient temperature	$T_A = 25\text{ °C}$
Source impedance	$Z_S = 50\ \Omega$
Load impedance	$Z_L = 2\text{ k}\Omega \parallel 3\text{ pF}$

		min.	typ.	max.	
Insertion attenuation					
Reference level for the following data	38,00 MHz	14,0	15,3	17,0	dB
Relative attenuation					
Picture carrier	39,50 MHz	4,8	5,8	6,8	dB
Color carrier	35,07 MHz	2,8	3,8	4,8	dB
Sound carrier	33,50 MHz	21,1	22,1	23,1	dB
Adjacent picture carrier	31,50 MHz	48,0	60,0	—	dB
	31,00 MHz	45,0	52,0	—	dB
	32,00 MHz	45,0	52,0	—	dB
	40,95 MHz	36,0	42,0	—	dB
Adjacent sound carrier	41,50 MHz	44,0	54,0	—	dB
Lower sidelobe	25,00 ... 31,50 MHz	44,0	50,0	—	dB
Upper sidelobe	41,50 ... 45,00 MHz	36,0	40,0	—	dB
Reflected wave signal suppression					
1,0 μ s ... 6,0 μ s after main pulse (test pulse: 250 ns, carrier frequency: 38,00 MHz)		44,0	52,0	—	dB
Feedthrough signal suppression					
0,9 μ s ... 0,8 μ s before main pulse (test pulse: 250 ns, carrier frequency: 38,00 MHz)		50,0	56,0	—	dB
Group delay ripple (p-p)	$\Delta\tau$	—	40	—	ns
Impedance at 38,00 MHz					
Input:	$Z_{IN} = R_{IN} \parallel C_{IN}$	—	2,0 \parallel 10,0	—	k Ω \parallel pF
Output:	$Z_{OUT} = R_{OUT} \parallel C_{OUT}$	—	2,2 \parallel 4,5	—	k Ω \parallel pF
Temperature coefficient of frequency	TC_f	—	-72	—	ppm/K

Frequency response

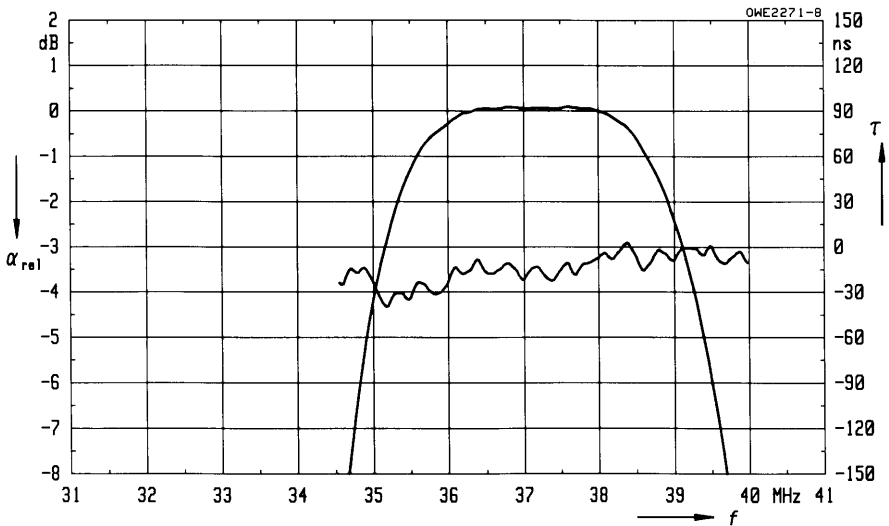
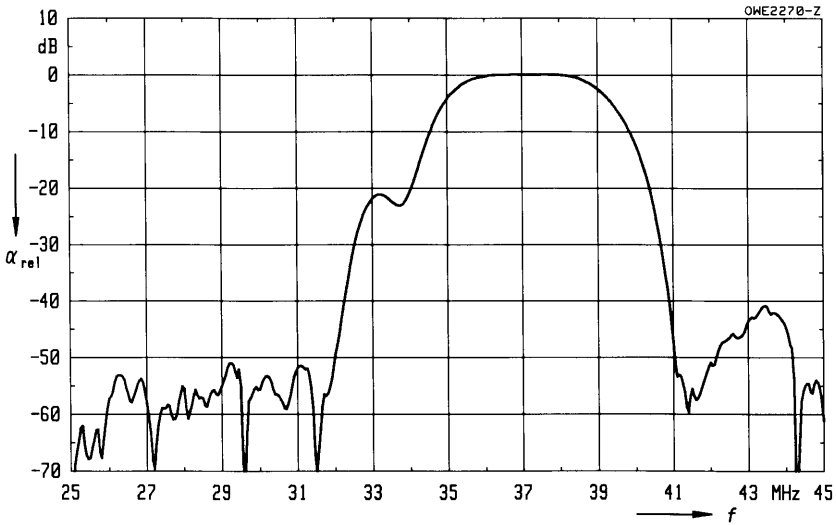

Standard

- M/N-FCC
USA

Features

- TV IF filter with Nyquist slope and sound shelf
- Constant group delay

Terminals

- Tinned CuFe alloy

Plastic package **SIP 5 K**

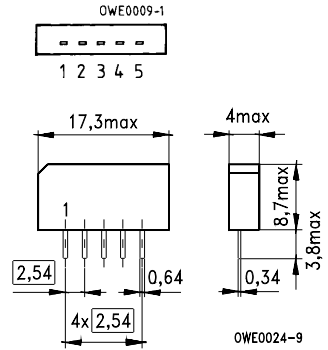

Dimensions in mm, approx. weight 1,0 g

Pin configuration

- 1 Input
- 2 Input – ground
- 3 Chip carrier – ground
- 4 Output
- 5 Output

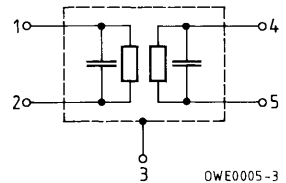

Type	Ordering code	Marking
M 1859 M	B39458-M1859-M100	Type, date code, pin 1

Maximum ratings

Ambient temperature	T_A	- 25/+ 65	°C	—
Storage temperature	T_{stg}	- 25/+ 85	°C	—
DC voltage	V_{DC}	12	V	between any terminals
AC voltage	V_{pp}	10	V	between any terminals

Characteristics

Ambient temperature $T_A = 25 (45) \text{ }^\circ\text{C}$
 Source impedance $Z_S = 50 \text{ } \Omega$
 Load impedance $Z_L = 2 \text{ k}\Omega \parallel 3 \text{ pF}$

		min.	typ.	max.		
Insertion attenuation						
Reference level for the following data	44,06 (44,00) MHz	α	11,7	13,2	14,7	dB
Relative attenuation						
Picture carrier	45,81 (45,75) MHz	α_{rel}	4,8	5,8	6,8	dB
Color carrier	42,23 (42,17) MHz		3,5	4,5	5,5	dB
Sound carrier	41,31 (41,25) MHz		15,6	17,1	18,6	dB
Adjacent picture carrier	39,81 (39,75) MHz		44,0	59,0	—	dB
Adjacent sound carrier	47,31 (47,25) MHz		40,0	52,0	—	dB
Lower sidelobe						
	35,06 ... 39,81 (35,00 ... 39,75) MHz		38,0	44,0	—	dB
Upper sidelobe						
	47,31 ... 55,06 (47,25 ... 55,00) MHz		36,0	42,0	—	dB
Reflected wave signal suppression						
1,1 μs ... 6,0 μs after main pulse (test pulse: 250 ns, carrier frequency: 44,06 MHz)			40,0	46,0	—	dB
Feedthrough signal suppression						
0,9 μs ... 0,8 μs before main pulse (test pulse: 250 ns, carrier frequency: 44,06 MHz)			50,0	56,0	—	dB
Group delay ripple (p-p)		$\Delta\tau$	—	40	—	ns
Impedance at 44,06 MHz						
Input: $Z_{IN} = R_{IN} \parallel C_{IN}$			—	1,5 \parallel 9,5	—	$\text{k}\Omega \parallel \text{pF}$
Output: $Z_{OUT} = R_{OUT} \parallel C_{OUT}$			—	1,3 \parallel 3,3	—	$\text{k}\Omega \parallel \text{pF}$
Temperature coefficient of frequency		TC_f	—	-72	—	ppm/K

M 1859 M
45,75 MHz

Frequency response

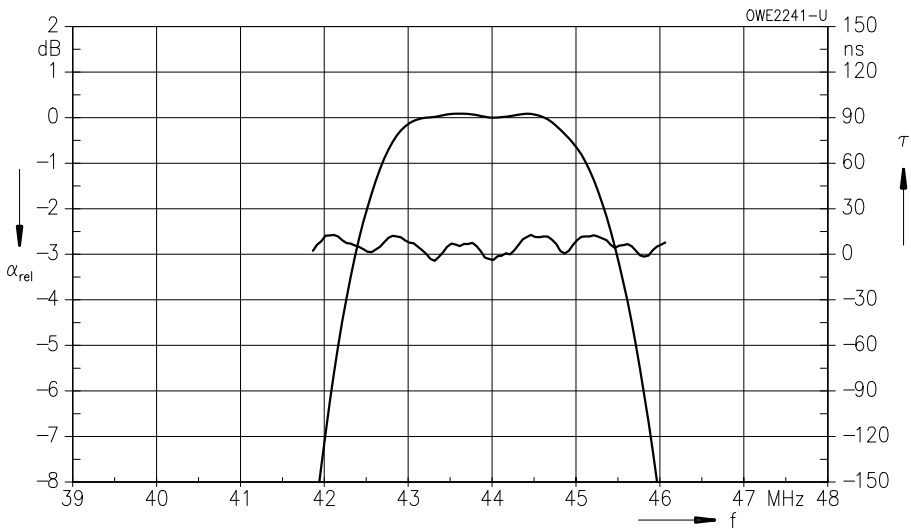
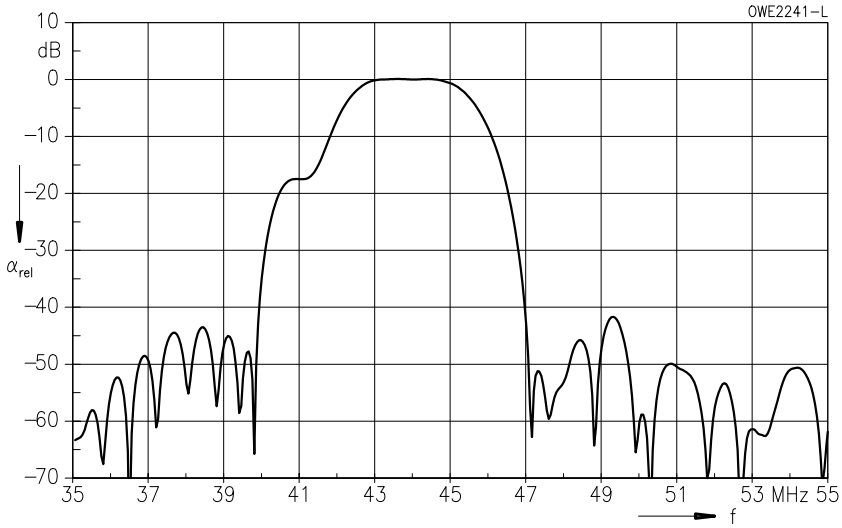

Standard

- M/N-FCC
USA

Features

- TV IF filter with Nyquist slope and sound shelf
- Constant group delay
- Suitable for FCC EIA/IS-31 regulations

Terminals

- Tinned CuFe alloy

Plastic package **SIP 5 K**

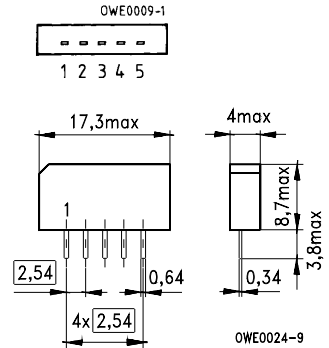

Dimensions in mm, approx. weight 1,0 g

Pin configuration

- 1 Input
- 2 Input – ground
- 3 Chip carrier – ground
- 4 Output
- 5 Output

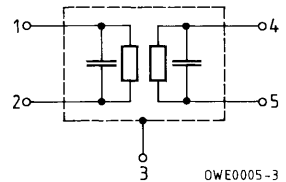

Type	Ordering code	Marking
M 1962 M	B39458-M1962-M100	Type, date code, pin 1

Maximum ratings

Ambient temperature	T_A	- 25/+ 65	°C	—
Storage temperature	T_{stg}	- 25/+ 85	°C	—
DC voltage	V_{DC}	12	V	between any terminals
AC voltage	V_{pp}	10	V	between any terminals

M 1962 M

45,75 MHz

Characteristics

Ambient temperature	$T_A = 25\text{ °C}$
Source impedance	$Z_S = 50\ \Omega$
Load impedance	$Z_L = 2\text{ k}\Omega \parallel 3\text{ pF}$

		min.	typ.	max.		
Insertion attenuation						
Reference level for the following data	44,00 MHz	α	10,0	11,4	13,0	dB
Relative attenuation						
Picture carrier	45,75 MHz	α_{rel}	4,1	5,1	6,1	dB
Color carrier	42,17 MHz		4,2	5,2	6,2	dB
Sound carrier	41,25 MHz		18,7	19,7	20,7	dB
Adjacent picture carrier	39,75 MHz		50,0	62,0	—	dB
Adjacent sound carrier	47,25 MHz		50,0	61,0	—	dB
Lower sidelobe	35,00 ... 39,75 MHz		44,0	49,0	—	dB
Upper sidelobe	47,25 ... 55,00 MHz		42,0	47,0	—	dB
Reflected wave signal suppression						
1,0 μ s ... 6,0 μ s after main pulse (test pulse: 250 ns, carrier frequency: 44,00 MHz)			44,0	50,0	—	dB
Feedthrough signal suppression						
1,1 μ s ... 0,9 μ s before main pulse (test pulse: 250 ns, carrier frequency: 44,00 MHz)			50,0	56,0	—	dB
Group delay ripple (p-p)		$\Delta\tau$	—	40	—	ns
Impedance at 44,00 MHz						
Input: $Z_{IN} = R_{IN} \parallel C_{IN}$			—	1,0 \parallel 12,5	—	k Ω \parallel pF
Output: $Z_{OUT} = R_{OUT} \parallel C_{OUT}$			—	0,7 \parallel 5,1	—	k Ω \parallel pF
Temperature coefficient of frequency		TC_f	—	-72	—	ppm/K

Frequency response

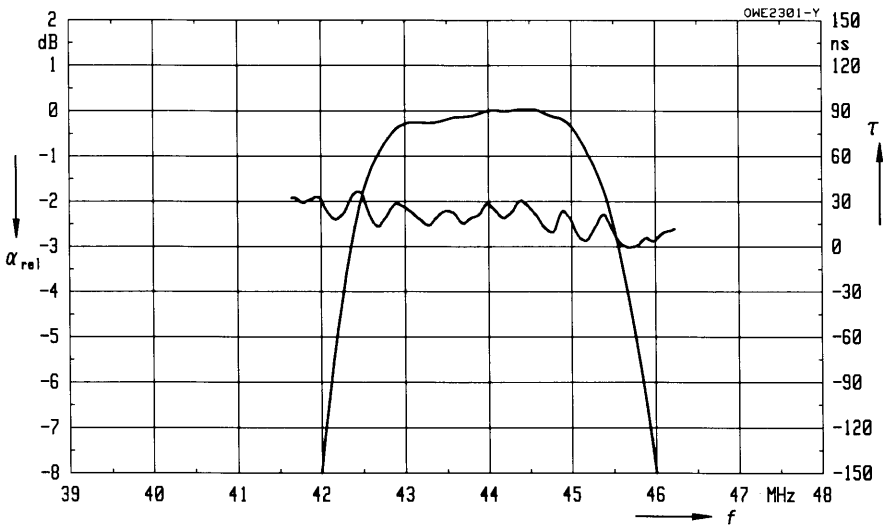
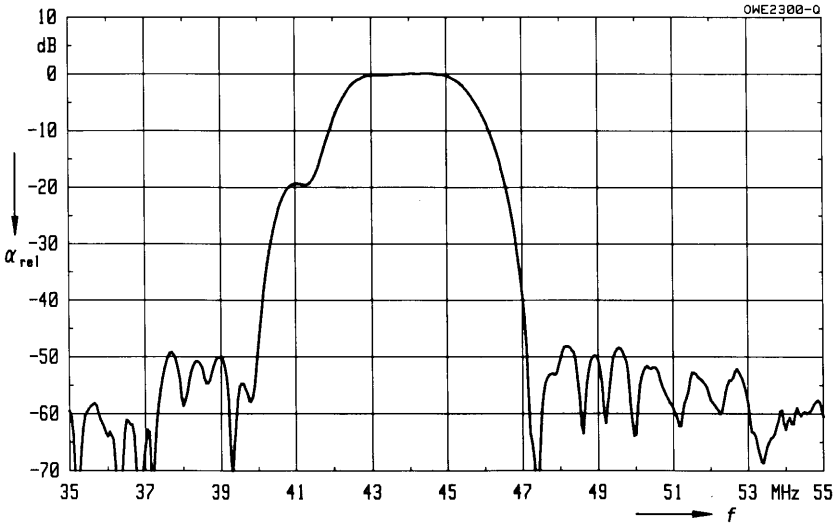

Standard

- M
Japan

Features

- TV IF filter with Nyquist slope and sound shelf
- Constant group delay

Terminals

- Tinned CuFe alloy

Plastic package **SIP 5 K**

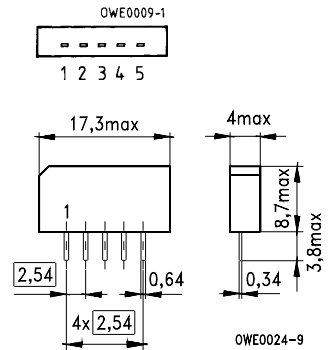

Dimensions in mm, approx. weight 1,0 g

Pin configuration

- 1 Input
- 2 Input – ground
- 3 Chip carrier – ground
- 4 Output
- 5 Output

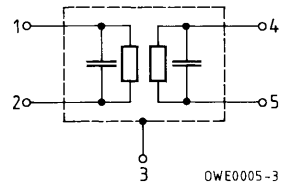

Type	Ordering code	Marking
N 1951 M	B39588-N1951-M100	Type, date code, pin 1

Maximum ratings

Ambient temperature	T_A	- 25/+ 65	°C	—
Storage temperature	T_{stg}	- 25/+ 85	°C	—
DC voltage	V_{DC}	12	V	between any terminals
AC voltage	V_{pp}	10	V	between any terminals

Characteristics

Ambient temperature $T_A = 25 (45) \text{ }^\circ\text{C}$
 Source impedance $Z_S = 50 \text{ } \Omega$
 Load impedance $Z_L = 2 \text{ k}\Omega \parallel 3 \text{ pF}$

		min.	typ.	max.		
Insertion attenuation						
Reference level for the following data	57,08 (57,00) MHz	α	10,8	12,3	13,8	dB
Relative attenuation						
Picture carrier	58,83 (58,75) MHz	α_{rel}	4,0	5,0	6,0	dB
Color carrier	55,25 (55,17) MHz		3,0	4,0	5,0	dB
Sound carrier	54,33 (54,25) MHz		17,0	18,0	19,0	dB
Adjacent picture carrier	52,83 (52,75) MHz		42,0	50,0	—	dB
Adjacent sound carrier	60,33 (60,25) MHz		38,0	43,0	—	dB
Lower sidelobe						
	45,08 ... 52,83 (45,00 ... 52,75) MHz		36,0	42,0	—	dB
Upper sidelobe						
	60,33 ... 65,08 (60,25 ... 65,00) MHz		35,0	41,0	—	dB
Reflected wave signal suppression						
1,0 μs ... 6,0 μs after main pulse (test pulse: 250 ns, carrier frequency: 57,08 MHz)			40,0	48,0	—	dB
Feedthrough signal suppression						
1,1 μs ... 1,0 μs before main pulse (test pulse: 250 ns, carrier frequency: 57,08 MHz)			50,0	56,0	—	dB
Group delay ripple (p-p)		$\Delta\tau$	—	50	—	ns
Impedance at 57,08 MHz						
Input: $Z_{IN} = R_{IN} \parallel C_{IN}$			—	1,0 \parallel 7,7	—	k Ω \parallel pF
Output: $Z_{OUT} = R_{OUT} \parallel C_{OUT}$			—	0,9 \parallel 2,9	—	k Ω \parallel pF
Temperature coefficient of frequency		TC_f	—	-72	—	ppm/K

N 1951 M
58,75 MHz

Frequency response

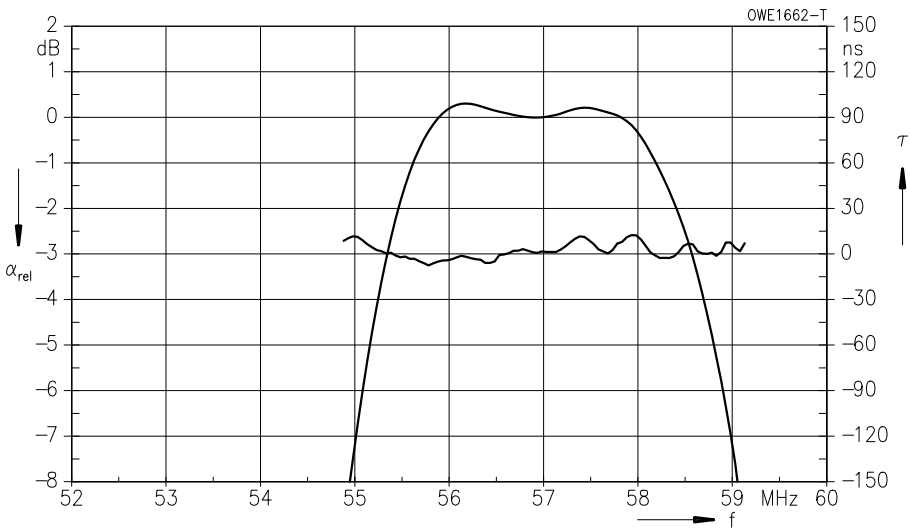
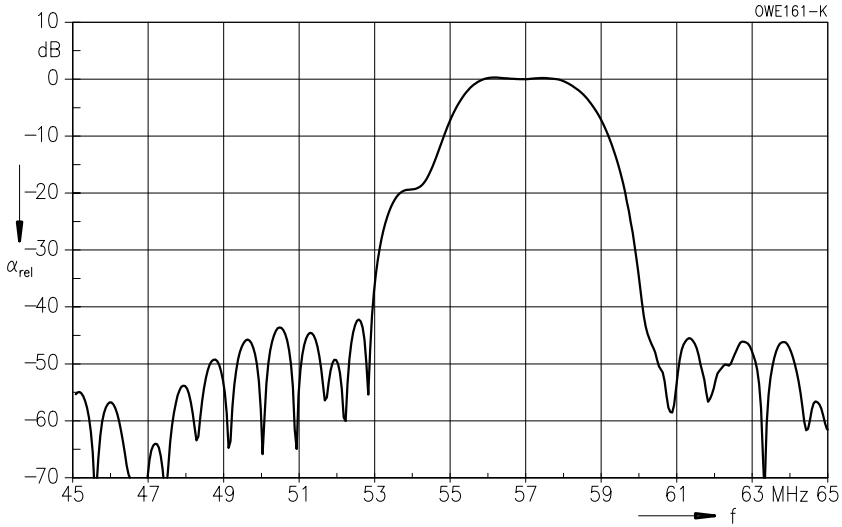

IF Filters for Quasi/Split Sound Applications

Survey

Picture carrier	Picture-to-sound carrier distance	Group delay ¹⁾	Sound carrier rejection ²⁾	Standard ³⁾	Package	Type	Page ⁴⁾
MHz	MHz	ns	dB				
33,90	- 6,5	F	51	L	DIP 10 K	K 3261 K	116
36,88	5,5	N	50	B	DIP 10 K	B 3250 K	#
38,00	6,5 ⁵⁾	F	52	D/K	DIP 10 K ⁶⁾	D 3650 K	#
	5,5 ... 6,5	C	35, 39	D/K	DIP 10 K	K 3264 K	120
38,90	5,5 ... 5,85	C	33, 23	B/G NICAM	DIP 10 K	G 3254 K	#
	5,5 ... 5,85	C	44, 46	B/G NICAM	DIP 10 K	G 3255 K	#
	5,5 ... 5,85	C	37, 25	B/G NICAM	DIP 10 K	G 3258 K	124
	5,5 ... 5,85	C	36, 23	B/G NICAM	DIP 10 K	G 3264 K	128
	5,5 ... 5,85	F	43, 26	B/G NICAM	DIP 10 K	G 3270 K ⁷⁾	#
	5,5 ... 5,85 ⁵⁾	C	41, 23	B/G NICAM	DIP 10 K ⁶⁾	G 3354 K	#
	5,5 ... 5,85 ⁵⁾	C	48, 25	B/G NICAM	DIP 10 K	G 3355 K	132
	5,5 ... 5,85 ⁵⁾	F	56, 45	B/G NICAM	DIP 10 K	G 3356 K	#
	5,5 ... 5,85 ⁵⁾	C	50, 46	B/G NICAM	DIP 10 K ⁶⁾	G 3357 K	#
	5,5 ... 5,85 ⁵⁾	F	35, 23	B/G NICAM	DIP 10 K ⁶⁾	G 3652 K	#
	6,0 ... 6,55	F	44, 48	I NICAM	DIP 10 K	J 3251 K	136
	6,0 ... 6,55 ⁵⁾	F	43, 47	I NICAM	DIP 10 K ⁶⁾	J 3351 K	140
	6,0 ... 6,55 ⁵⁾	F	56, 52	I NICAM	DIP 10 K ⁶⁾	J 3652 K	#
	6,5 ⁵⁾	F	42	L	DIP 10 K	K 3252 K	#
	4,5 ... 6,5	C	44, 56, 28	B/G, D/K, I	DIP 10 K	K 3258 K	144
5,5	F	25	B/G	DIP 10 K	K 3261 K	116	
5,5 ... 6,5 ⁵⁾	C	43, 55	B/G, D/K	DIP 10 K	K 3350 K	148	
39,50	6,0 ... 6,55	F	59, 46	I NICAM	DIP 10 K	J 3252 K	152
	6,0 ... 6,55 ⁵⁾	F	55, 51	I NICAM	DIP 10 K	J 3352 K	156
45,75	4,5	F	43	M/N	DIP 10 K	M 3251 K	#
	4,5	F	29	M/N	DIP 10 K	M 3271 K ⁷⁾	160
	4,5 ⁵⁾	F	40	M/N	DIP 10 K	M 3352 K	#
	4,5 ⁵⁾	F	28	M/N	DIP 10 K	M 3353 K	#
	4,5 ⁵⁾	F	32	M/N	DIP 10 K	M 3354 K	164
	4,5 ⁵⁾	F	40	M/N	DIP 10 K ⁶⁾	M 3355 K	#
	4,5 ⁵⁾	F	34	M/N	SIP 5 K ⁶⁾	M 3561 M	168
	4,5 ⁵⁾	C	39	M/N	DIP 10 K ⁶⁾	M 3654 K	172
58,75	4,5 ⁵⁾	F	29	M	SIP 5 K ⁶⁾	N 3561 M	177

1) N: Conforming with standard
C: Customized
F: Flat

2) Typ., referred to filter roof

3) For explanation of standards see individual data sheets or index on page [349](#)

4) Filters marked by the sign # are only listed in the survey. Detailed information on these types upon request.

5) Sound channel with sound passband only

6) Pin configuration different from standard package

7) Optimized for twin PLL ICs

Standard

Plastic package DIP 10 K

- B/G-CCIR
Germany, Europe partly
- I
Great Britain
- L, L'
France

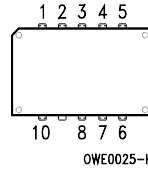

Features

- TV IF filter for quasi/split sound applications (separate picture and sound channel)
- Picture channel with two Nyquist slopes at 33,90 MHz and 38,90 MHz
- Constant group delay
- Sound channel with pass bands for picture carrier and sound carrier at 33,40 MHz and 33,05 MHz (NICAM)

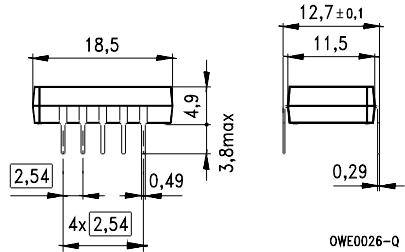

Terminals

- Tinned CuFe alloy

Dimensions in mm, approx. weight 1,8 g

Pin configuration

- 1 Input
- 2 Input – ground
- 3, 8 Chip carrier – ground
- 4, 5 Output – sound
- 6, 7 Output – picture
- 9 Free
- 10 Not connected

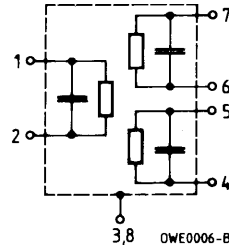

Type	Ordering code	Marking
K 3261 K	B39389-K3261-K100	Type, date code, pin 1

Maximum ratings

Ambient temperature	T_A	- 25/+ 65	°C	—
Storage temperature	T_{stg}	- 25/+ 85	°C	—
DC voltage	V_{DC}	12	V	between any terminals
AC voltage	V_{pp}	10	V	between any terminals

Characteristics of picture channel

Ambient temperature $T_A = 25\text{ }^\circ\text{C}$
 Source impedance $Z_S = 50\ \Omega$
 Load impedance $Z_L = 2\ \text{k}\Omega \parallel 3\ \text{pF}$

		min.	typ.	max.	
Insertion attenuation					
	α				
Reference level for the following data	37,40 MHz	14,0	15,5	17,0	dB
Relative attenuation					
	α_{rel}				
	38,90 MHz	5,4	6,4	7,4	dB
	33,90 MHz	5,4	6,4	7,4	dB
Sound carrier	33,40 MHz	20,0	25,0	—	dB
Adjacent picture carrier	UHF 30,90 MHz	44,0	50,0	—	dB
	VHF 31,90 MHz	46,0	54,0	—	dB
	32,40 MHz	40,0	45,0	—	dB
	40,15 MHz	36,0	42,0	—	dB
Adjacent sound carrier	VHF 40,40 MHz	42,0	51,0	—	dB
	UHF 41,40 MHz	42,0	55,0	—	dB
Lower sidelobe	25,00 ... 32,40 MHz	38,0	46,0	—	dB
Upper sidelobe	40,40 ... 45,00 MHz	36,0	42,0	—	dB
Reflected wave signal suppression					
1,1 μs ... 6,0 μs after main pulse (test pulse: 250 ns, carrier frequency: 37,40 MHz)		42,0	53,0	—	dB
Feedthrough signal suppression					
1,2 μs ... 1,0 μs before main pulse (test pulse: 250 ns, carrier frequency: 37,40 MHz)		—	56,0	—	dB
Group delay ripple (p-p)					
	$\Delta\tau$	—	40	—	ns
Impedance at 37,40 MHz					
	Input: $Z_{\text{IN}} = R_{\text{IN}} \parallel C_{\text{IN}}$	—	1,4 \parallel 23,7	—	k Ω \parallel pF
	Output: $Z_{\text{OUT}} = R_{\text{OUT}} \parallel C_{\text{OUT}}$	—	1,9 \parallel 4,2	—	k Ω \parallel pF
Temperature coefficient of frequency					
	TC_f	—	- 72	—	ppm/K

Frequency response

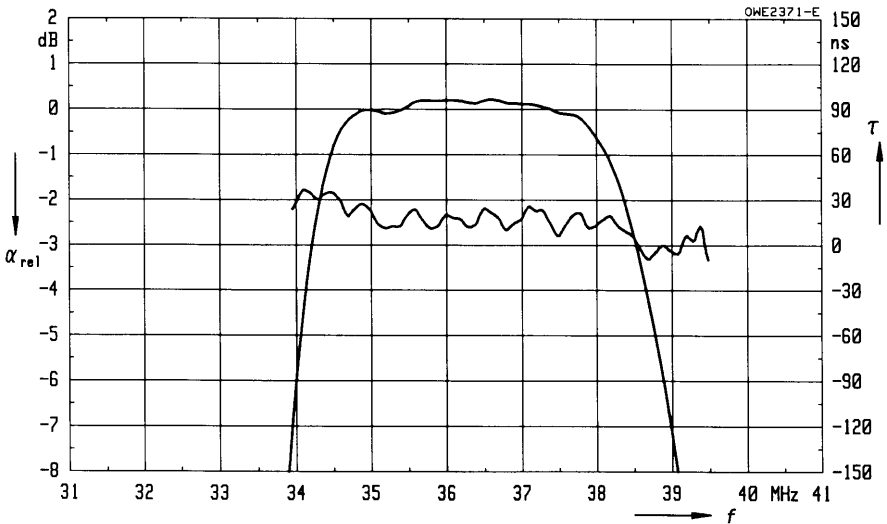
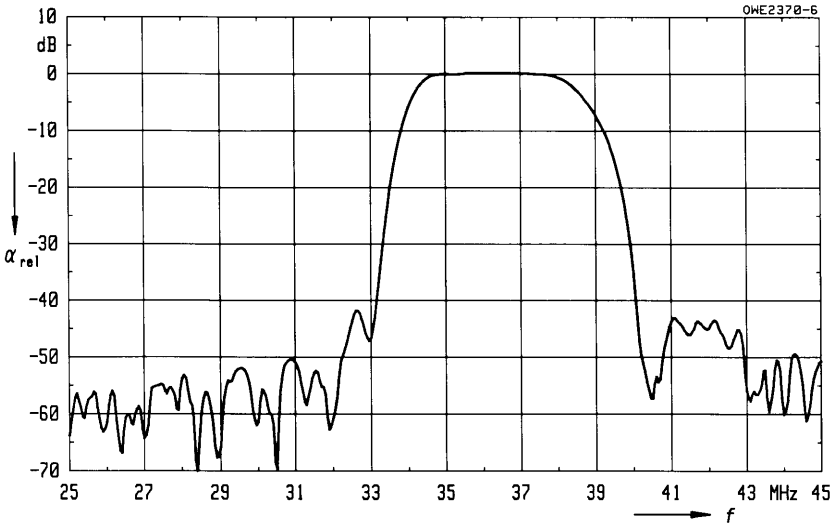

Characteristics of sound channel

Ambient temperature $T_A = 25\text{ }^\circ\text{C}$
 Source impedance $Z_S = 50\ \Omega$
 Load impedance $Z_L = 2\text{ k}\Omega \parallel 3\text{ pF}$

		min.	typ.	max.	
Insertion attenuation	α				
Reference level for the following data	38,90 MHz	19,0	20,5	22,0	dB
Relative attenuation	α_{rel}				
	33,05 MHz	-1,8	-0,8	0,2	dB
Sound carrier	33,40 MHz	-0,5	0,5	1,5	dB
Color carrier	34,47 MHz	24,0	38,0	—	dB
Adjacent picture carrier	31,90 MHz	36,0	41,0	—	dB
Adjacent sound carrier	40,40 MHz	32,0	39,0	—	dB
Lower sidelobe	25,00 ... 31,90 MHz	28,0	34,0	—	dB
Upper sidelobe	40,40 ... 45,00 MHz	28,0	35,0	—	dB
Group delay ripple (p-p)	$\Delta\tau$	—	50	—	ns
Impedance at 38,90 MHz					
Output: $Z_{OUT} = R_{OUT} \parallel C_{OUT}$		—	5,3 3,5	—	k Ω pF
Temperature coefficient of frequency	TC_f	—	-72	—	ppm/K

Frequency response

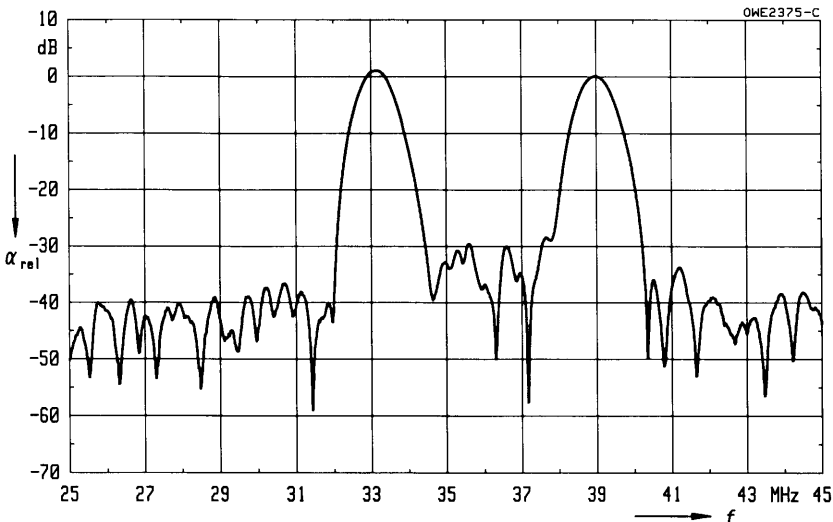

Standard

- D/K-OIRT
Eastern standard

Plastic package DIP 10 K

Features

- TV IF filter for quasi/split sound applications (separate picture and sound channel)
- Picture channel with Nyquist slope and sound suppression
- Customized group delay predistortion
- Sound channel with pass bands for picture carrier and sound carrier at 31,50 MHz and 32,50 MHz

Terminals

- Tinned CuFe alloy

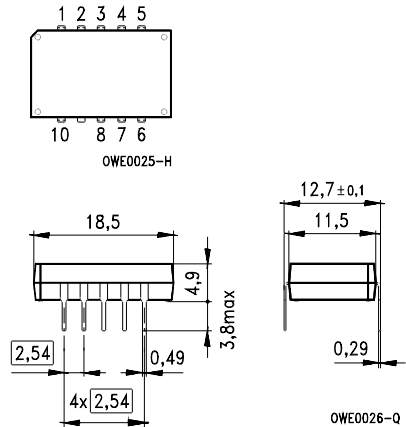

Dimensions in mm, approx. weight 1,8 g

Pin configuration

- 1 Input
- 2 Input – ground
- 3, 8 Chip carrier – ground
- 4, 5 Output – sound
- 6, 7 Output – picture
- 9 Free
- 10 Not connected

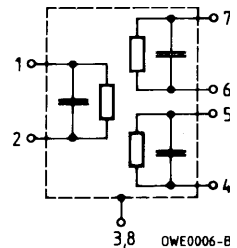

Type	Ordering code	Marking
K 3264 K	B39380-K3264-K100	Type, date code, pin 1

Maximum ratings

Ambient temperature	T_A	- 25/+ 65	°C	—
Storage temperature	T_{stg}	- 25/+ 85	°C	—
DC voltage	V_{DC}	12	V	between any terminals
AC voltage	V_{pp}	10	V	between any terminals

Characteristics of picture channel

Ambient temperature $T_A = 25\text{ }^\circ\text{C}$
 Source impedance $Z_S = 50\text{ }\Omega$
 Load impedance $Z_L = 2\text{ k}\Omega \parallel 3\text{ pF}$

		min.	typ.	max.	
Insertion attenuation					
	α				
Reference level for the following data	36,50 MHz	18,0	1 9,5	21,0	dB
Relative attenuation					
	α_{rel}				
Picture carrier	38,00 MHz	5,2	6,2	7,2	dB
Color carrier	33,57 MHz	- 0,4	0,6	1,6	dB
	33,20 MHz	2,2	3,2	4,2	dB
Sound carrier	32,50 MHz	20,0	35,0	—	dB
	31,50 MHz	20,0	39,0	—	dB
Adjacent picture carrier	30,00 MHz	42,0	47,0	—	dB
Adjacent sound carrier	39,50 MHz	38,0	50,0	—	dB
Lower sidelobe	25,00 ... 30,00 MHz	36,0	40,0	—	dB
Upper sidelobe	39,50 ... 45,00 MHz	32,0	35,0	—	dB
Reflected wave signal suppression					
1,2 μs ... 6,0 μs after main pulse (test pulse: 250 ns, carrier frequency: 36,50 MHz)		42,0	52,0	—	dB
Feedthrough signal suppression					
1,2 μs ... 1,0 μs before main pulse (test pulse: 250 ns, carrier frequency: 36,50 MHz)		—	56,0	—	dB
Group delay predistortion					
	$\Delta\tau$				
(reference frequency 38,00 MHz)					
	35,20 MHz	—	- 75	—	ns
	33,57 MHz	—	- 15	—	ns
Impedance at 36,50 MHz					
Input: $Z_{IN} = R_{IN} \parallel C_{IN}$		—	2,1 \parallel 18,8	—	k Ω \parallel pF
Output: $Z_{OUT} = R_{OUT} \parallel C_{OUT}$		—	3,6 \parallel 2,7	—	k Ω \parallel pF
Temperature coefficient of frequency					
	TC_f	—	- 72	—	ppm/K

Frequency response

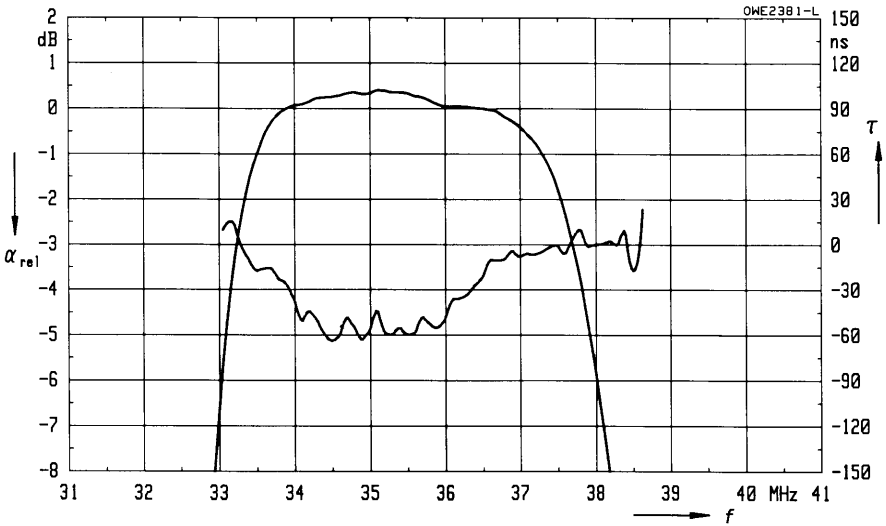
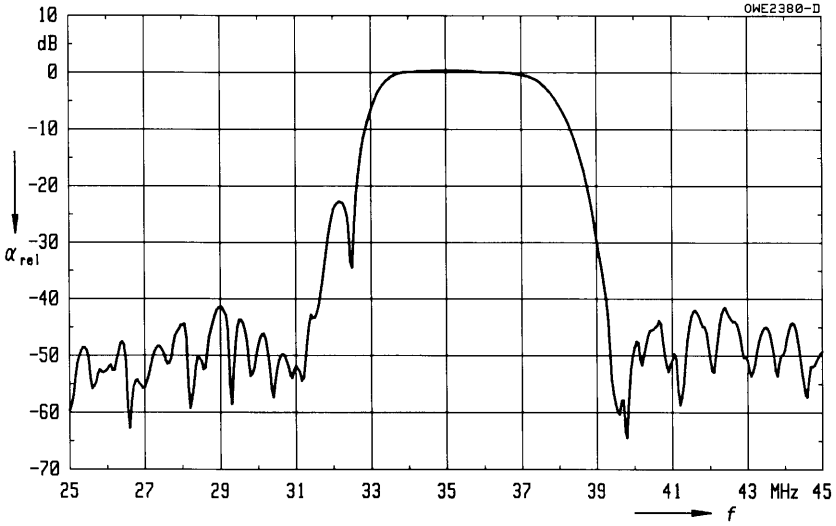

Characteristics of sound channel

Ambient temperature $T_A = 25\text{ }^\circ\text{C}$
 Source impedance $Z_S = 50\ \Omega$
 Load impedance $Z_L = 2\ \text{k}\Omega \parallel 3\ \text{pF}$

		min.	typ.	max.	
Insertion attenuation α					
Reference level for the following data	38,00 MHz	20,0	21,5	23,0	dB
Relative attenuation α_{rel}					
Sound carrier	31,50 MHz	-1,6	-0,6	0,4	dB
	32,50 MHz	-0,8	0,2	1,2	dB
Color carrier	33,57 MHz	18,0	24,0	—	dB
Adjacent picture carrier	30,00 MHz	36,0	41,0	—	dB
Adjacent sound carrier	39,50 MHz	30,0	38,0	—	dB
Lower sidelobe	25,00 ... 30,00 MHz	30,0	36,0	—	dB
Upper sidelobe	39,50 ... 45,00 MHz	24,0	31,0	—	dB
Impedance at 38,00 MHz					
	Output: $Z_{OUT} = R_{OUT} \parallel C_{OUT}$	—	4,6 \parallel 3,2	—	k Ω \parallel pF
Temperature coefficient of frequency TC_f		—	-72	—	ppm/K

Frequency response

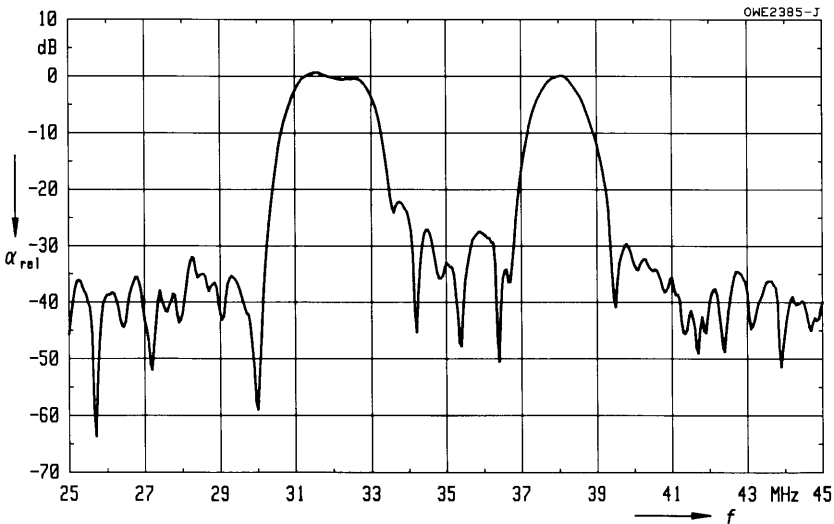

Standard

Plastic package **DIP 10 K**

- B/G-CCIR
Germany, Europe partly

Features

- TV IF filter for quasi/split sound applications (separate picture and sound channel)
- Picture channel with Nyquist slope and sound suppression
- High color carrier level
- Reduced group delay predistortion as compared with standard B/G, half
- Sound channel with pass bands for picture carrier and sound carriers at 33,40 MHz and 33,05 MHz (NICAM)
- Suitable for CENELEC EN 55020

Terminals

- Tinned CuFe alloy

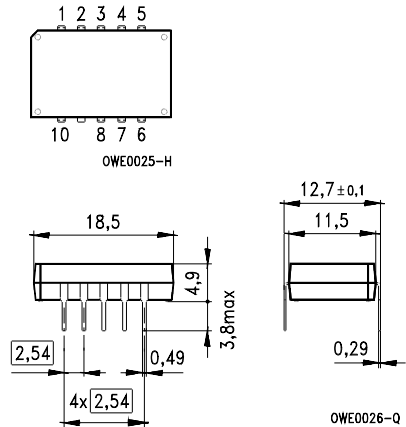

Dimensions in mm, approx. weight 1,8 g

Pin configuration

- 1 Input
- 2 Input – ground
- 3, 8 Chip carrier – ground
- 4, 5 Output – sound
- 6, 7 Output – picture
- 9 Free
- 10 Not connected

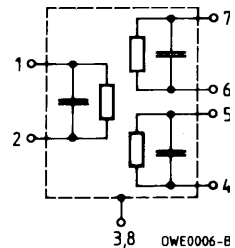

Type	Ordering code	Marking
G 3258 K	B39389-G3258-K100	Type, date code, pin 1

Maximum ratings

Ambient temperature	T_A	- 25/+ 65	°C	—
Storage temperature	T_{stg}	- 25/+ 85	°C	—
DC voltage	V_{DC}	12	V	between any terminals
AC voltage	V_{pp}	10	V	between any terminals

Characteristics of picture channel

Ambient temperature $T_A = 25\text{ °C}$
 Source impedance $Z_S = 50\ \Omega$
 Load impedance $Z_L = 2\text{ k}\Omega \parallel 3\text{ pF}$

		min.	typ.	max.	
Insertion attenuation					
	α				
Reference level for the following data	37,40 MHz	14,3	15,8	17,3	dB
Relative attenuation					
	α_{rel}				
Picture carrier	38,90 MHz	5,2	6,2	7,2	dB
Color carrier	34,47 MHz	-0,8	0,2	1,2	dB
Sound carrier	33,40 MHz	28,0	37,0	—	dB
Adjacent picture carrier	UHF 30,90 MHz	45,0	56,0	—	dB
	VHF 31,90 MHz	46,0	58,0	—	dB
	32,40 MHz	42,0	49,0	—	dB
	40,15 MHz	37,0	42,0	—	dB
Adjacent sound carrier	VHF 40,40 MHz	45,0	58,0	—	dB
	UHF 41,40 MHz	42,0	55,0	—	dB
Lower sidelobe	25,00 ... 31,90 MHz	42,0	49,0	—	dB
Upper sidelobe	40,40 ... 45,00 MHz	38,0	44,0	—	dB
Reflected wave signal suppression					
1,2 μ s ... 6,0 μ s after main pulse (test pulse: 250 ns, carrier frequency: 37,40 MHz)		42,0	54,0	—	dB
Feedthrough signal suppression					
1,3 μ s ... 1,2 μ s before main pulse (test pulse: 250 ns, carrier frequency: 37,40 MHz)		—	56,0	—	dB
Group delay predistortion					
	$\Delta\tau$				
(reference frequency 38,90 MHz)					
	36,40 MHz	—	-35	—	ns
	34,47 MHz	—	40	—	ns
Impedance at 37,40 MHz					
Input: $Z_{IN} = R_{IN} \parallel C_{IN}$		—	1,4 \parallel 24,7	—	k Ω \parallel pF
Output: $Z_{OUT} = R_{OUT} \parallel C_{OUT}$		—	1,9 \parallel 3,5	—	k Ω \parallel pF
Temperature coefficient of frequency					
	TC_f	—	-72	—	ppm/K

Frequency response

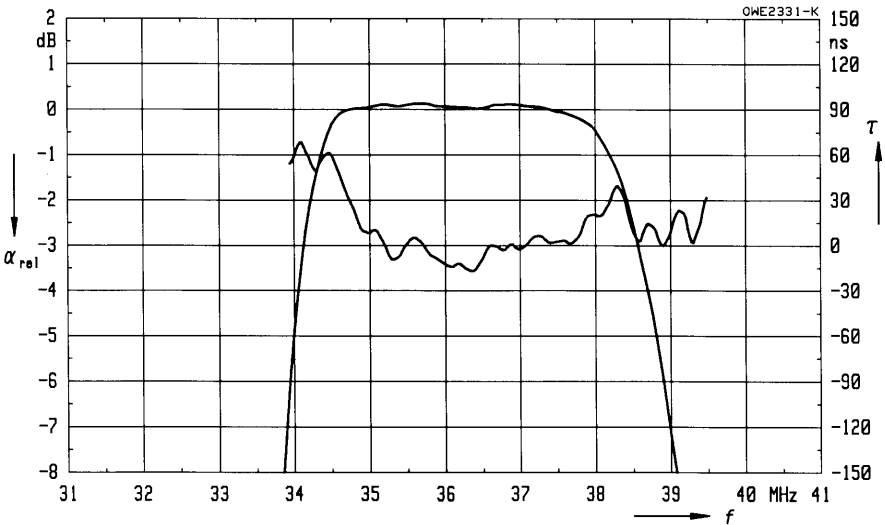
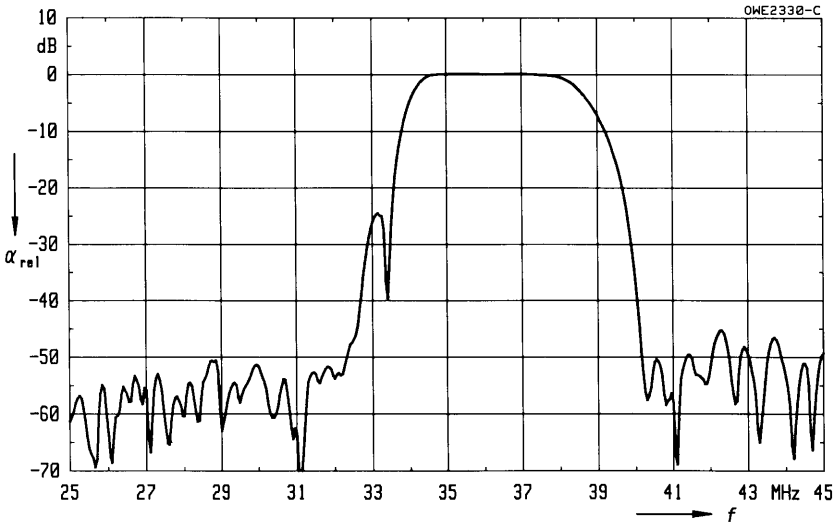

Characteristics of sound channel

Ambient temperature $T_A = 25\text{ }^\circ\text{C}$
 Source impedance $Z_S = 50\text{ }\Omega$
 Load impedance $Z_L = 2\text{ k}\Omega \parallel 3\text{ pF}$

		min.	typ.	max.	
Insertion attenuation					
	α				
Reference level for the following data	33,05 MHz	18,3	19,8	21,3	dB
Relative attenuation					
	α_{rel}				
Sound carrier	33,40 MHz	0,5	1,5	2,5	dB
Picture carrier	38,90 MHz	0,1	1,1	2,1	dB
Color carrier	34,47 MHz	24,0	30,0	—	dB
Adjacent picture carrier	UHF 30,90 MHz	38,0	46,0	—	dB
	VHF 31,90 MHz	39,0	48,0	—	dB
Adjacent sound carrier	VHF 40,40 MHz	34,0	42,0	—	dB
	UHF 41,40 MHz	36,0	44,0	—	dB
Lower sidelobe	25,00 ... 31,90 MHz	30,0	37,0	—	dB
Upper sidelobe	40,40 ... 45,00 MHz	30,0	37,0	—	dB
Impedance at 33,05 MHz					
	Output: $Z_{OUT} = R_{OUT} \parallel C_{OUT}$	—	11,7 \parallel 4,5	—	k Ω \parallel pF
Temperature coefficient of frequency					
	TC_f	—	-72	—	ppm/K

Frequency response

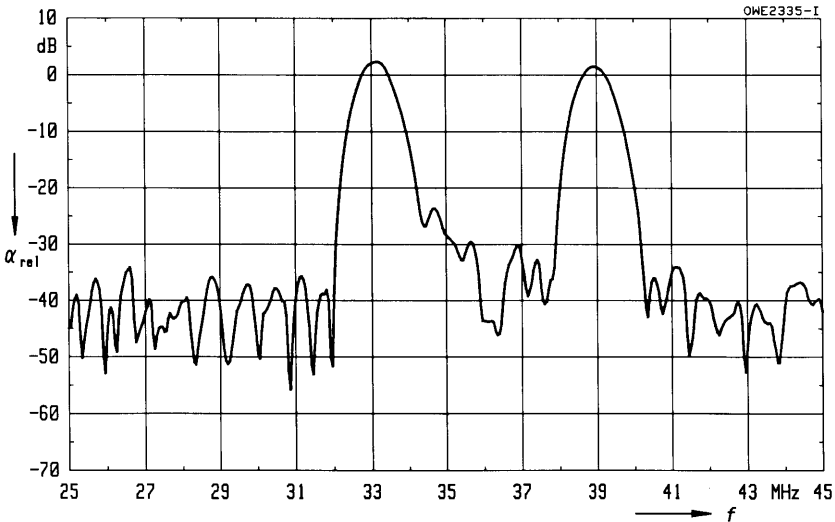

Standard

Plastic package **DIP 10 K**

- B/G-CCIR
Germany, Europe partly

Features

- TV IF filter for quasi/split sound applications (separate picture and sound channel)
- Picture channel with Nyquist slope and sound suppression
- High color carrier level
- Reduced group delay predistortion as compared with standard B/G, half
- Sound channel with pass bands for picture carrier and sound carriers at 33,40 MHz and 33,05 MHz (NICAM)
- Suitable for CENELEC EN 55020

Terminals

- Tinned CuFe alloy

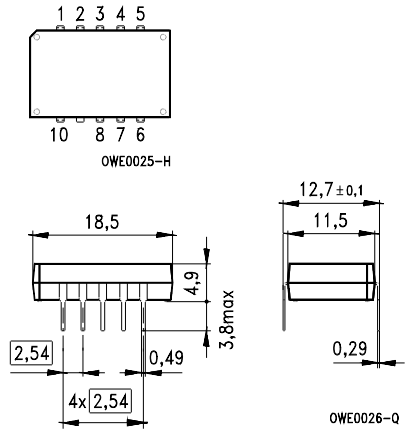

Dimensions in mm, approx. weight 1,8 g

Pin configuration

- 1 Input
- 2 Input – ground
- 3, 8 Chip carrier – ground
- 4, 5 Output – sound
- 6, 7 Output – picture
- 9 Free
- 10 Not connected

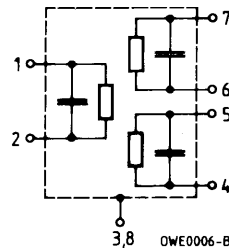

Type	Ordering code	Marking
G 3264 K	B39389-G3264-K100	Type, date code, pin 1

Maximum ratings

Ambient temperature	T_A	- 25/+ 65	°C	—
Storage temperature	T_{stg}	- 25/+ 85	°C	—
DC voltage	V_{DC}	12	V	between any terminals
AC voltage	V_{pp}	10	V	between any terminals

Characteristics of picture channel

Ambient temperature $T_A = 25\text{ °C}$
 Source impedance $Z_S = 50\ \Omega$
 Load impedance $Z_L = 2\text{ k}\Omega \parallel 3\text{ pF}$

		min.	typ.	max.	
Insertion attenuation					
	α				
Reference level for the following data	37,40 MHz	14,5	16,0	17,5	dB
Relative attenuation					
	α_{rel}				
Picture carrier	38,90 MHz	5,1	6,1	7,1	dB
Color carrier	34,47 MHz	-0,9	0,1	1,1	dB
Sound carrier	33,40 MHz	26,0	36,0	—	dB
Adjacent picture carrier	UHF 30,90 MHz	44,0	53,0	—	dB
	VHF 31,90 MHz	46,0	60,0	—	dB
	32,40 MHz	42,0	53,0	—	dB
	40,15 MHz	40,0	47,0	—	dB
Adjacent sound carrier	VHF 40,40 MHz	46,0	57,0	—	dB
	UHF 41,40 MHz	44,0	54,0	—	dB
Lower sidelobe	25,00 ... 31,90 MHz	39,0	44,0	—	dB
Upper sidelobe	40,40 ... 45,00 MHz	39,0	45,0	—	dB
Reflected wave signal suppression					
1,2 μ s ... 6,0 μ s after main pulse (test pulse: 250 ns, carrier frequency: 37,40 MHz)		42,0	55,0	—	dB
Feedthrough signal suppression					
1,2 μ s ... 1,0 μ s before main pulse (test pulse: 250 ns, carrier frequency: 37,40 MHz)		—	56,0	—	dB
Group delay predistortion					
	$\Delta\tau$				
(reference frequency 38,90 MHz)					
	36,10 MHz	—	-70	—	ns
	34,47 MHz	—	120	—	ns
Impedance at 37,40 MHz					
	Input: $Z_{IN} = R_{IN} \parallel C_{IN}$	—	1,3 \parallel 25,0	—	k Ω \parallel pF
	Output: $Z_{OUT} = R_{OUT} \parallel C_{OUT}$	—	1,7 \parallel 3,7	—	k Ω \parallel pF
Temperature coefficient of frequency					
	TC_f	—	-72	—	ppm/K

Frequency response

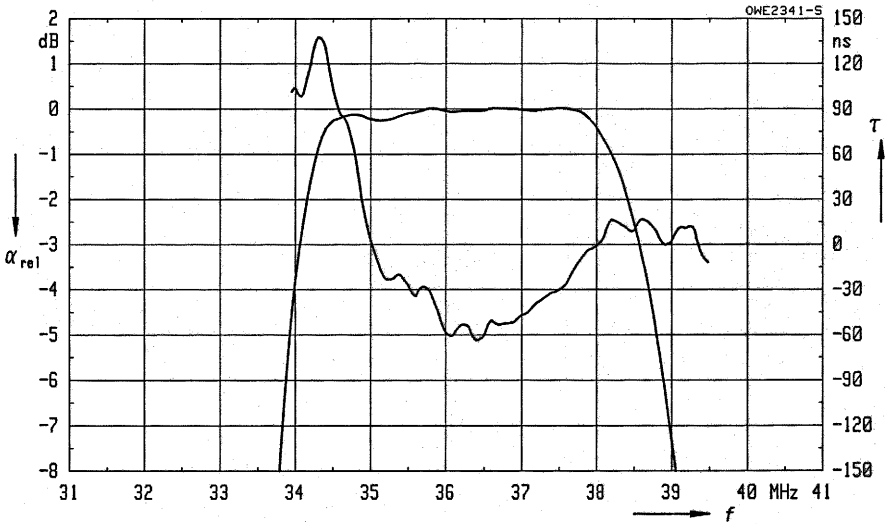
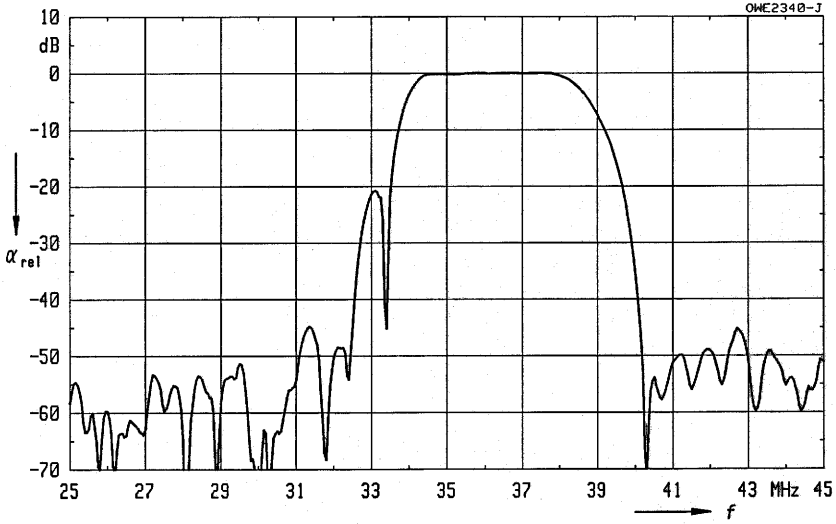

Characteristics of sound channel

Ambient temperature $T_A = 25\text{ °C}$
 Source impedance $Z_S = 50\ \Omega$
 Load impedance $Z_L = 2\text{ k}\Omega \parallel 3\text{ pF}$

		min.	typ.	max.	
Insertion attenuation	α				
Reference level for the following data	38,90 MHz	18,6	20,1	21,6	dB
Relative attenuation	α_{rel}				
Sound carrier	33,40 MHz	-0,9	0,3	1,5	dB
NICAM sound carrier	33,05 MHz	-2,0	-1,0	0,0	dB
Color carrier	34,47 MHz	20,0	29,0	—	dB
In-band trap	36,15 MHz	25,0	37,0	—	dB
Adjacent picture carrier	31,90 MHz	36,0	45,0	—	dB
Adjacent sound carrier	40,40 MHz	30,0	39,0	—	dB
Lower sidelobe	25,00 ... 31,90 MHz	28,0	38,0	—	dB
Upper sidelobe	40,40 ... 45,00 MHz	26,0	35,0	—	dB
Group delay ripple (p-p)	$\Delta\tau$	—	40	—	ns
Impedance at 38,90 MHz					
Output: $Z_{OUT} = R_{OUT} \parallel C_{OUT}$		—	5,4 3,1	—	k Ω pF
Temperature coefficient of frequency	TC_f	—	-72	—	ppm/K

Frequency response

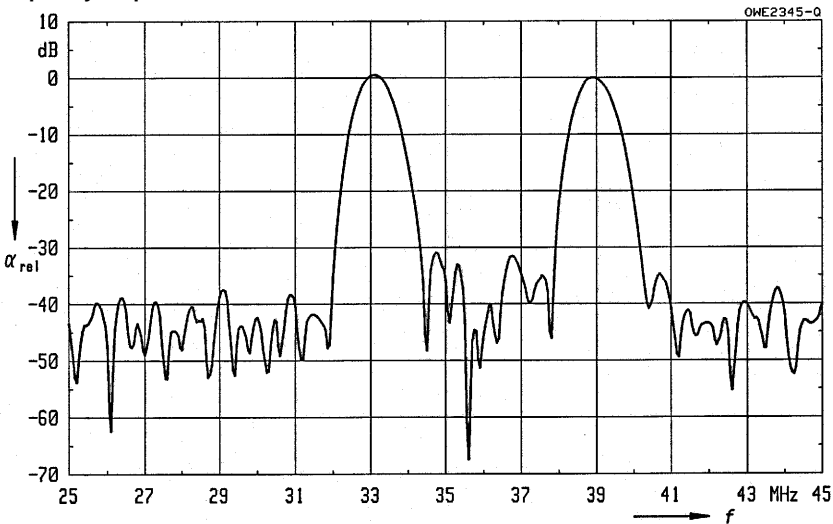

Standard

Plastic package DIP 10 K

- B/G-CCIR
Germany, Europe partly

Features

- TV IF filter for quasi/split sound applications (separate picture and sound channel)
- Picture channel with Nyquist slope and sound suppression
- Customized group delay predistortion
- Sound channel with pass bands for sound carriers at 33,40 MHz and 33,05 MHz (NICAM)
- Suitable for CENELEC EN 55020

Terminals

- Tinned CuFe alloy

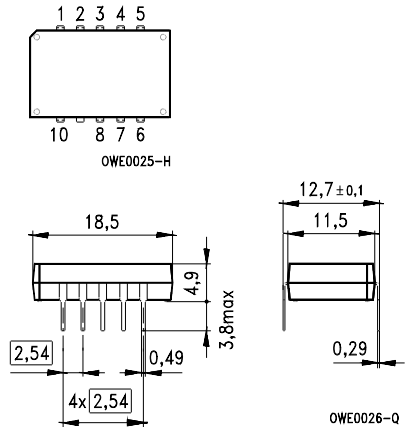

Dimensions in mm, approx. weight 1,8 g

Pin configuration

- 1 Input
- 2 Input – ground
- 3, 8 Chip carrier – ground
- 4, 5 Output – sound
- 6, 7 Output – picture
- 9 Free
- 10 Not connected

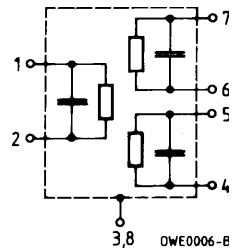

Type	Ordering code	Marking
G 3355 K	B39389-G3355-K100	Type, date code, pin 1

Maximum ratings

Ambient temperature	T_A	- 25/+ 65	°C	—
Storage temperature	T_{stg}	- 25/+ 85	°C	—
DC voltage	V_{DC}	12	V	between any terminals
AC voltage	V_{pp}	10	V	between any terminals

Characteristics of picture channel

Ambient temperature $T_A = 25\text{ °C}$
 Source impedance $Z_S = 50\ \Omega$
 Load impedance $Z_L = 2\text{ k}\Omega \parallel 3\text{ pF}$

		min.	typ.	max.	
Insertion attenuation					
	α				
Reference level for the following data	37,40 MHz	13,5	15,0	16,5	dB
Relative attenuation					
	α_{rel}				
Picture carrier	38,90 MHz	5,5	6,5	7,5	dB
Color carrier	34,47 MHz	-0,6	0,4	1,4	dB
Sound carrier	33,40 MHz	30,0	48,0	—	dB
Adjacent picture carrier	UHF 30,90 MHz	46,0	60,0	—	dB
	VHF 31,90 MHz	48,0	56,0	—	dB
	32,40 MHz	46,0	55,0	—	dB
	40,15 MHz	40,0	48,0	—	dB
Adjacent sound carrier	VHF 40,40 MHz	46,0	60,0	—	dB
	UHF 41,40 MHz	45,0	59,0	—	dB
Lower sidelobe	25,00 ... 31,90 MHz	40,0	46,0	—	dB
Upper sidelobe	40,40 ... 45,00 MHz	40,0	46,0	—	dB
Reflected wave signal suppression					
1,2 μ s ... 6,0 μ s after main pulse (test pulse: 250 ns, carrier frequency: 37,40 MHz)		42,0	52,0	—	dB
Feedthrough signal suppression					
1,2 μ s ... 1,1 μ s before main pulse (test pulse: 250 ns, carrier frequency: 37,40 MHz)		50,0	56,0	—	dB
Group delay predistortion					
	$\Delta\tau$				
(reference frequency 38,90 MHz)					
	36,40 MHz	—	-55	—	ns
	34,47 MHz	—	40	—	ns
Impedance at 37,40 MHz					
	Input: $Z_{IN} = R_{IN} \parallel C_{IN}$	—	1,0 \parallel 24,4	—	k Ω \parallel pF
	Output: $Z_{OUT} = R_{OUT} \parallel C_{OUT}$	—	1,6 \parallel 3,9	—	k Ω \parallel pF
Temperature coefficient of frequency					
	TC_f	—	-72	—	ppm/K

Frequency response

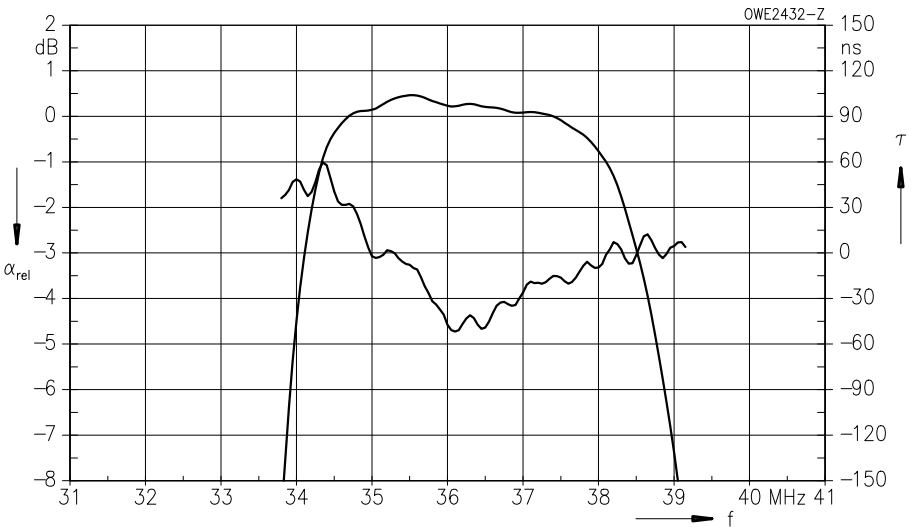
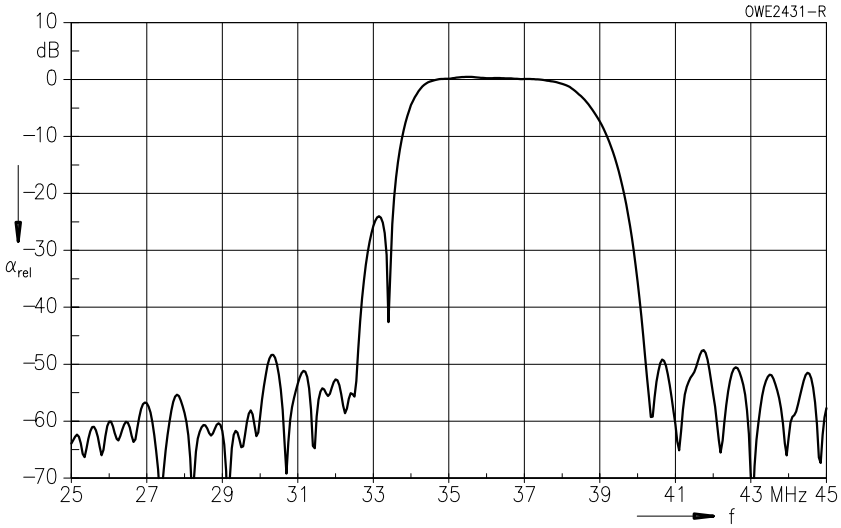

Characteristics of sound channel

Ambient temperature $T_A = 25\text{ }^\circ\text{C}$
 Source impedance $Z_S = 50\text{ }\Omega$
 Load impedance $Z_L = 2\text{ k}\Omega \parallel 3\text{ pF}$

		min.	typ.	max.	
Insertion attenuation					
	α				
Reference level for the following data	33,05 MHz	14,8	16,3	17,8	dB
Relative attenuation					
	α_{rel}				
Sound carrier	33,40 MHz	1,0	2,0	3,0	dB
Picture carrier	38,90 MHz	42,0	56,0	—	dB
Color carrier	34,47 MHz	28,0	35,0	—	dB
Adjacent picture carrier	UHF 30,90 MHz	30,0	37,0	—	dB
	VHF 31,90 MHz	32,0	41,0	—	dB
Adjacent sound carrier	VHF 40,40 MHz	42,0	53,0	—	dB
	UHF 41,40 MHz	42,0	54,0	—	dB
Lower sidelobe	25,00 ... 31,90 MHz	28,0	34,0	—	dB
Upper sidelobe	38,90 ... 45,00 MHz	38,0	46,0	—	dB
Impedance at 33,05 MHz					
Output: $Z_{OUT} = R_{OUT} \parallel C_{OUT}$		—	4,1 2,6	—	k Ω pF
Temperature coefficient of frequency					
	TC_f	—	-72	—	ppm/K

Frequency response

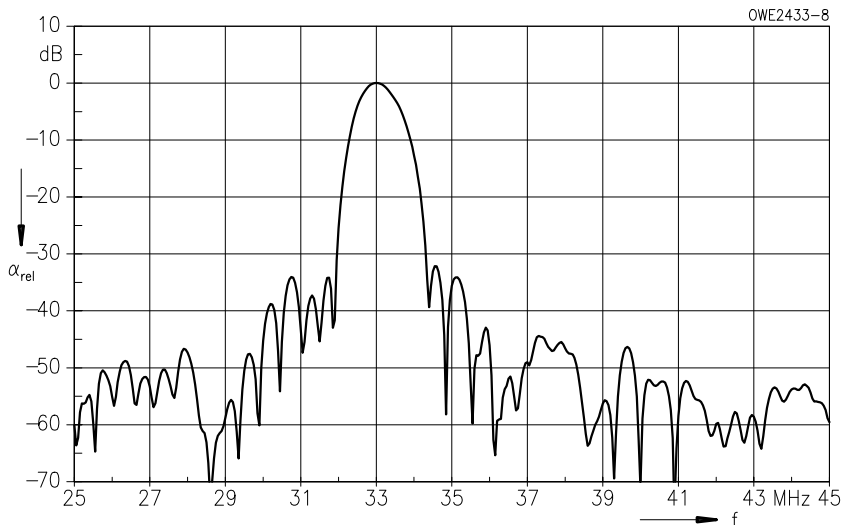

Standard

Plastic package DIP 10 K

- I
Great Britain

Features

- TV IF filter for quasi/split sound applications (separate picture and sound channel)
- Picture channel with Nyquist slope and sound suppression
- Constant group delay
- Sound channel with pass bands for picture carrier and sound carriers at 32,90 MHz and 32,35 MHz (NICAM)

Terminals

- Tinned CuFe alloy

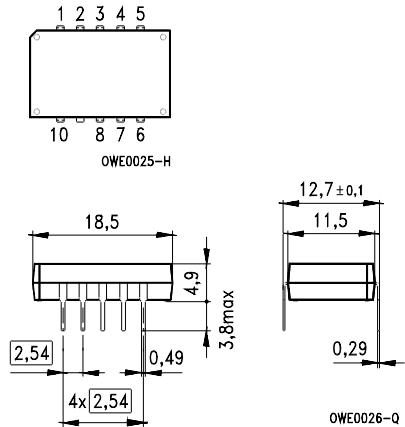

Dimensions in mm, approx. weight 1,8 g

Pin configuration

- 1 Input
- 2 Input – ground
- 3, 8 Chip carrier – ground
- 4, 5 Output – sound
- 6, 7 Output – picture
- 9 Free
- 10 Not connected

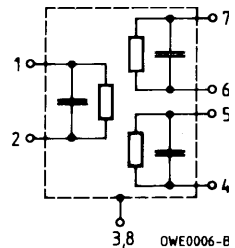

Type	Ordering code	Marking
J 3251 K	B39389-J3251-K100	Type, date code, pin 1

Maximum ratings

Ambient temperature	T_A	- 25/+ 65	°C	—
Storage temperature	T_{stg}	- 25/+ 85	°C	—
DC voltage	V_{DC}	12	V	between any terminals
AC voltage	V_{pp}	10	V	between any terminals

Characteristics of picture channel

Ambient temperature $T_A = 25\text{ }^\circ\text{C}$
 Source impedance $Z_S = 50\ \Omega$
 Load impedance $Z_L = 2\ \text{k}\Omega \parallel 3\ \text{pF}$

		min.	typ.	max.	
Insertion attenuation					
	α				
Reference level for the following data	37,00 MHz	15,0	16,5	18,0	dB
Relative attenuation					
	α_{rel}				
Picture carrier	38,90 MHz	4,4	5,4	6,4	dB
Color carrier	34,47 MHz	2,1	3,1	4,1	dB
Sound carrier	32,90 MHz	36,0	44,0	—	dB
NICAM sound carrier	32,35 MHz	40,0	48,0	—	dB
Adjacent picture carrier	30,90 MHz	44,0	53,0	—	dB
Adjacent sound carrier	40,90 MHz	40,0	46,0	—	dB
	40,35 MHz	36,0	43,0	—	dB
Lower sidelobe	25,00 ... 32,35 MHz	38,0	45,0	—	dB
Upper sidelobe	40,90 ... 45,00 MHz	35,0	41,0	—	dB
Reflected wave signal suppression					
0,8 μs ... 6,0 μs after main pulse (test pulse: 250 ns, carrier frequency: 37,00 MHz)		42,0	50,0	—	dB
Feedthrough signal suppression					
1,0 μs ... 0,9 μs before main pulse (test pulse: 250 ns, carrier frequency: 37,00 MHz)		—	56,0	—	dB
Group delay ripple (p-p)	$\Delta\tau$	—	50	—	ns
Impedance at 37,00 MHz					
Input: $Z_{\text{IN}} = R_{\text{IN}} \parallel C_{\text{IN}}$		—	1,5 \parallel 20,6	—	k Ω \parallel pF
Output: $Z_{\text{OUT}} = R_{\text{OUT}} \parallel C_{\text{OUT}}$		—	2,8 \parallel 4,5	—	k Ω \parallel pF
Temperature coefficient of frequency	TC_f	—	-72	—	ppm/K

Frequency response

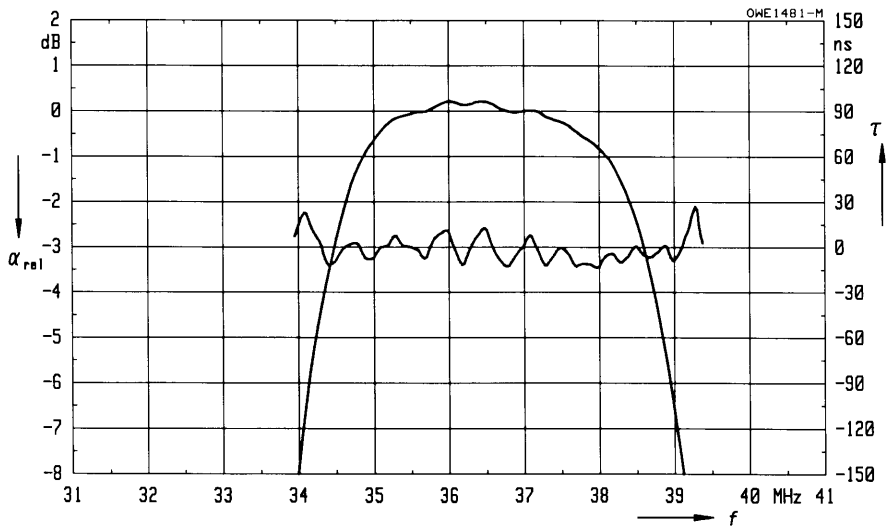
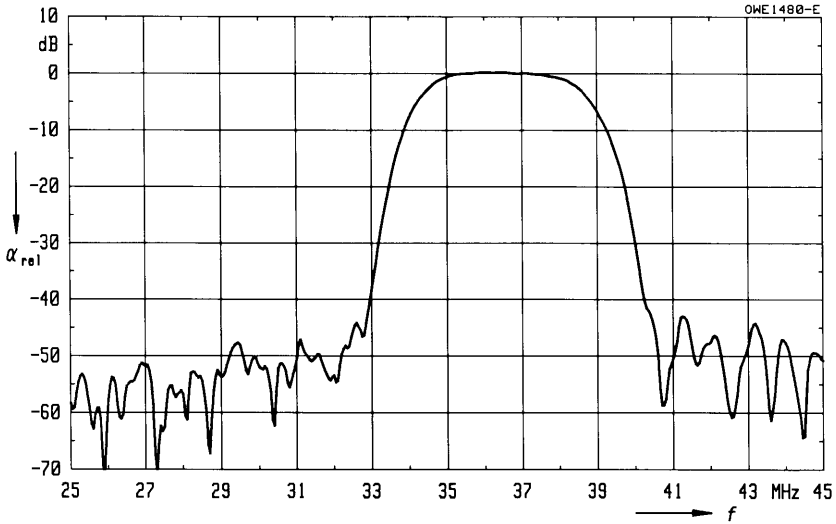

Characteristics of sound channel

Ambient temperature $T_A = 25\text{ }^\circ\text{C}$
 Source impedance $Z_S = 50\ \Omega$
 Load impedance $Z_L = 2\ \text{k}\Omega \parallel 3\ \text{pF}$

		min.	typ.	max.	
Insertion attenuation	α				
Reference level for the following data	38,90 MHz	22,5	24,2	25,5	dB
Relative attenuation	α_{rel}				
Sound carrier	32,90 MHz	0,8	1,8	2,8	dB
NICAM sound carrier	32,35 MHz	-0,8	0,2	1,2	dB
Color carrier	34,47 MHz	18,0	28,0	—	dB
Adjacent picture carrier	30,90 MHz	33,0	44,0	—	dB
Adjacent sound carrier	40,90 MHz	30,0	38,0	—	dB
Lower sidelobe	25,00 ... 30,90 MHz	30,0	37,0	—	dB
Upper sidelobe	40,90 ... 45,00 MHz	29,0	36,0	—	dB
Group delay ripple (p-p)	$\Delta\tau$	—	70	—	ns
Impedance at 38,90 MHz					
Output: $Z_{OUT} = R_{OUT} \parallel C_{OUT}$		—	8,9 2,7	—	k Ω pF
Temperature coefficient of frequency	TC_f	—	-72	—	ppm/K

Frequency response

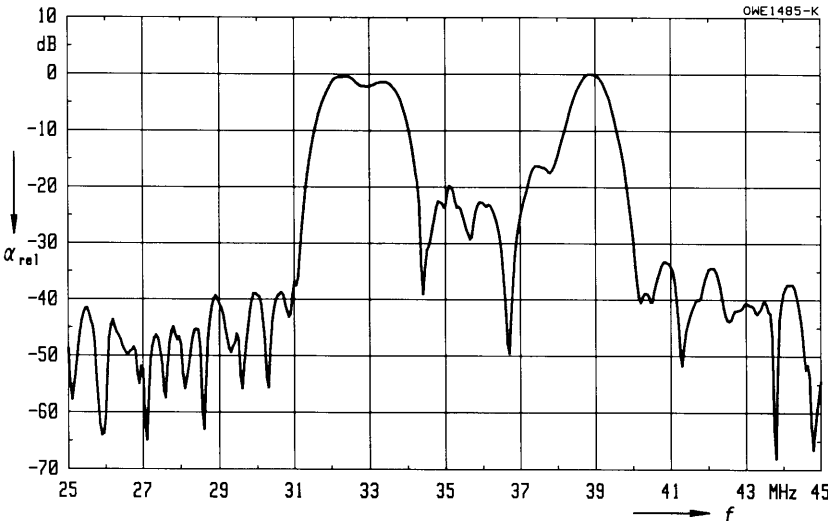

Standard

Plastic package DIP 10 K

- I
Great Britain

Features

- TV IF filter for quasi/split sound applications (separate picture and sound channel)
- Picture channel with Nyquist slope and sound suppression
- Constant group delay
- Sound channel with pass bands for sound carriers at 32,90 MHz and 32,35 MHz (NICAM)

Terminals

- Tinned CuFe alloy

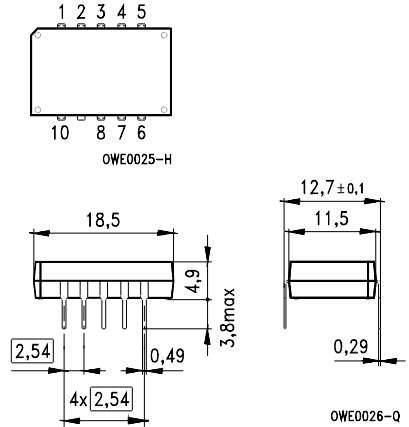

Dimensions in mm, approx. weight 1,8 g

Pin configuration

- 1 Input
- 2 Input – ground
- 3, 8 Chip carrier – ground
- 4, 5 Output – picture
- 6, 7 Output – sound
- 9 Free
- 10 Not connected

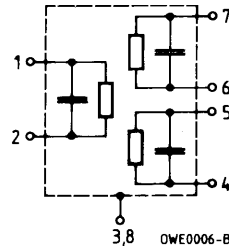

Type	Ordering code	Marking
J 3351 K	B39389-J3351-K100	Type, date code, pin 1

Maximum ratings

Ambient temperature	T_A	- 25/+ 65	°C	—
Storage temperature	T_{stg}	- 25/+ 85	°C	—
DC voltage	V_{DC}	12	V	between any terminals
AC voltage	V_{pp}	10	V	between any terminals

Characteristics of picture channel

Ambient temperature $T_A = 25\text{ }^\circ\text{C}$
 Source impedance $Z_S = 50\ \Omega$
 Load impedance $Z_L = 2\ \text{k}\Omega \parallel 3\ \text{pF}$

		min.	typ.	max.	
Insertion attenuation					
	α				
Reference level for the following data	37,40 MHz	17,0	18,6	20,0	dB
Relative attenuation					
	α_{rel}				
Picture carrier	38,90 MHz	4,4	5,4	6,4	dB
Color carrier	34,47 MHz	1,6	2,6	3,6	dB
Sound carrier	32,90 MHz	36,0	43,0	—	dB
NICAM sound carrier	32,35 MHz	40,0	47,0	—	dB
Adjacent picture carrier	30,90 MHz	46,0	57,0	—	dB
Adjacent sound carrier	40,90 MHz	41,0	50,0	—	dB
	40,35 MHz	37,0	43,0	—	dB
Lower sidelobe	25,00 ... 30,90 MHz	42,0	47,0	—	dB
Upper sidelobe	40,90 ... 45,00 MHz	38,0	44,0	—	dB
Reflected wave signal suppression					
0,8 μs ... 6,0 μs after main pulse (test pulse: 250 ns, carrier frequency: 37,40 MHz)		42,0	50,0	—	dB
Feedthrough signal suppression					
1,0 μs ... 0,9 μs before main pulse (test pulse: 250 ns, carrier frequency: 37,40 MHz)		—	56,0	—	dB
Group delay ripple (p-p)	$\Delta\tau$	—	40	—	ns
Impedance at 37,40 MHz					
Input: $Z_{\text{IN}} = R_{\text{IN}} \parallel C_{\text{IN}}$		—	1,9 \parallel 15,3	—	k Ω \parallel pF
Output: $Z_{\text{OUT}} = R_{\text{OUT}} \parallel C_{\text{OUT}}$		—	2,4 \parallel 3,4	—	k Ω \parallel pF
Temperature coefficient of frequency	TC_f	—	-72	—	ppm/K

Frequency response

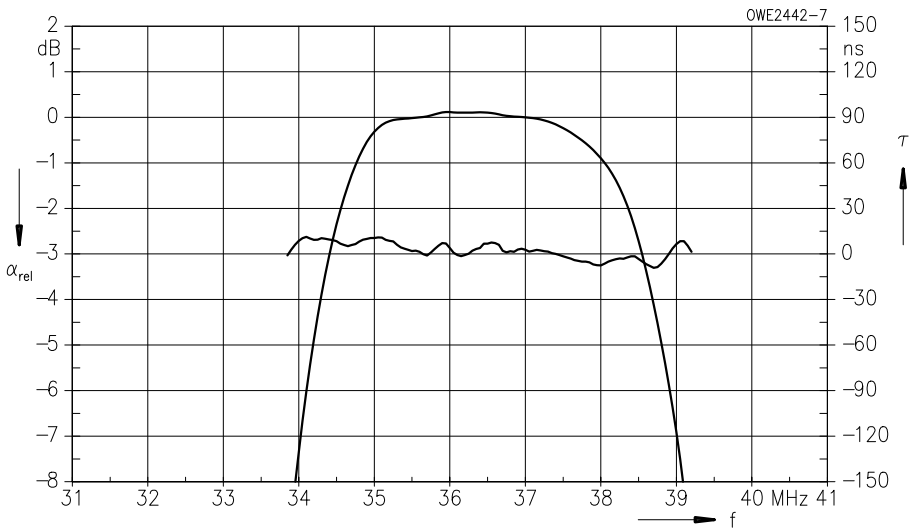
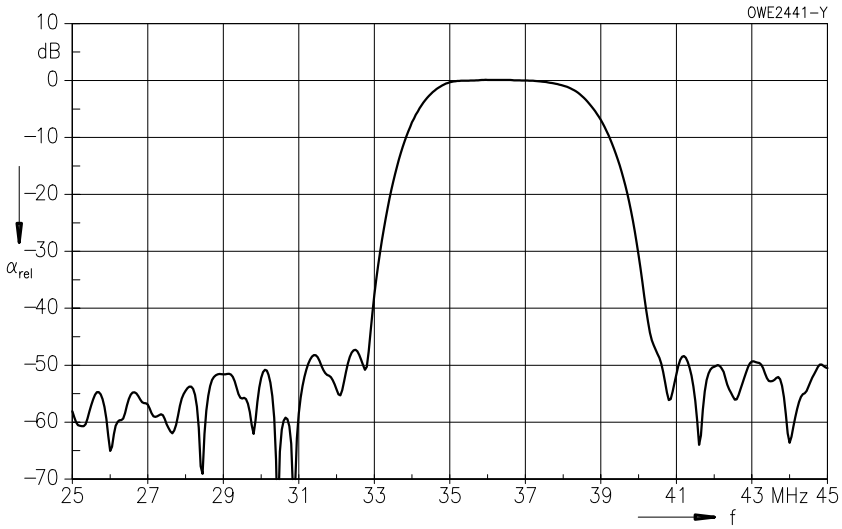

Characteristics of sound channel

Ambient temperature $T_A = 25\text{ °C}$
 Source impedance $Z_S = 50\ \Omega$
 Load impedance $Z_L = 2\text{ k}\Omega \parallel 3\text{ pF}$

		min.	typ.	max.	
Insertion attenuation	α				
Reference level for the following data	32,35 MHz	21,5	23,2	24,5	dB
Relative attenuation	α_{rel}				
Sound carrier	32,90 MHz	- 0,8	0,2	1,2	dB
	31,95 MHz	0,1	1,1	2,1	dB
Picture carrier	38,90 MHz	40,0	53,0	—	dB
Color carrier	34,47 MHz	25,0	30,0	—	dB
Adjacent picture carrier	30,90 MHz	28,0	40,0	—	dB
Adjacent sound carrier	40,90 MHz	38,0	50,0	—	dB
Lower sidelobe	25,00 ... 30,90 MHz	28,0	33,0	—	dB
Upper sidelobe	40,90 ... 45,00 MHz	35,0	42,0	—	dB
Group delay ripple (p-p)	$\Delta\tau$	—	70	—	ns
Impedance at 32,35 MHz					
Output: $Z_{OUT} = R_{OUT} \parallel C_{OUT}$		—	4,4 \parallel 3,2	—	k Ω \parallel pF
Temperature coefficient of frequency	TC_f	—	-72	—	ppm/K

Frequency response

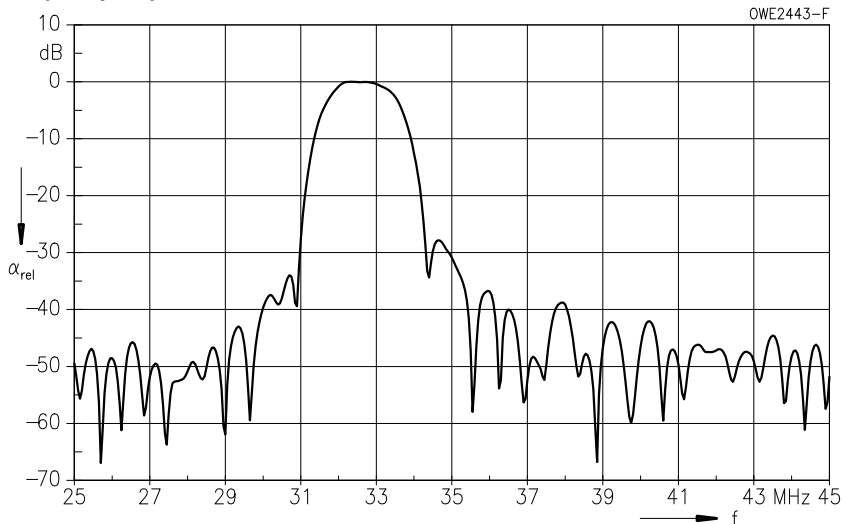

Standard

- B/G-CCIR
Germany, Europe partly
- D/K-OIRT
Eastern standard
- I
Great Britain

Plastic package DIP 10 K

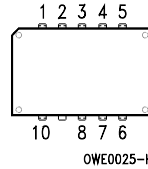

Features

- TV IF filter for quasi/split sound applications (separate picture and sound channel)
- Picture channel with Nyquist slope and sound suppression
- High color carrier level
- Highly reduced group delay pre-distortion
- Sound channel with pass bands for picture carrier and sound carriers between 32,40 MHz and 34,40 MHz

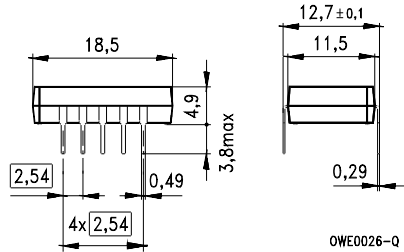

Terminals

- Tinned CuFe alloy

Dimensions in mm, approx. weight 1,8 g

Pin configuration

- 1 Input
- 2 Input – ground
- 3, 8 Chip carrier – ground
- 4, 5 Output – sound
- 6, 7 Output – picture
- 9 Free
- 10 Not connected

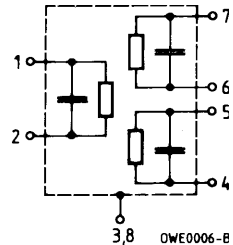

Type	Ordering code	Marking
K 3258 K	B39389-K3258-K100	Type, date code, pin 1

Maximum ratings

Ambient temperature	T_A	- 25/+ 65	°C	—
Storage temperature	T_{stg}	- 25/+ 85	°C	—
DC voltage	V_{DC}	12	V	between any terminals
AC voltage	V_{pp}	10	V	between any terminals

Characteristics of picture channel

Ambient temperature $T_A = 25\text{ °C}$
 Source impedance $Z_S = 50\ \Omega$
 Load impedance $Z_L = 2\text{ k}\Omega \parallel 3\text{ pF}$

		min.	typ.	max.	
Insertion attenuation					
	α				
Reference level for the following data	37,40 MHz	14,3	15,8	17,3	dB
Relative attenuation					
	α_{rel}				
Picture carrier	38,90 MHz	4,8	5,8	6,8	dB
Color carrier	34,47 MHz	- 0,7	0,3	1,3	dB
Sound carrier	33,40 MHz	30,0	44,0	—	dB
Adjacent picture carrier	UHF 30,90 MHz	42,0	49,0	—	dB
	VHF 31,90 MHz	40,0	50,0	—	dB
	32,40 MHz	44,0	56,0	—	dB
	40,15 MHz	36,0	42,0	—	dB
Adjacent sound carrier	VHF 40,40 MHz	42,0	52,0	—	dB
	UHF 41,40 MHz	40,0	48,0	—	dB
Lower sidelobe	25,00 ... 31,90 MHz	38,0	44,0	—	dB
Upper sidelobe	40,40 ... 45,00 MHz	38,0	46,0	—	dB
Reflected wave signal suppression					
1,3 μ s ... 6,0 μ s after main pulse (test pulse: 250 ns, carrier frequency: 37,40 MHz)		42,0	52,0	—	dB
Feedthrough signal suppression					
1,3 μ s ... 1,1 μ s before main pulse (test pulse: 250 ns, carrier frequency: 37,40 MHz)		—	56,0	—	dB
Group delay predistortion					
	$\Delta\tau$				
(reference frequency 38,90 MHz)					
	36,10 MHz	—	- 30	—	ns
	34,47 MHz	—	40	—	ns
Impedance at 37,40 MHz					
Input: $Z_{IN} = R_{IN} \parallel C_{IN}$		—	1,6 \parallel 23,6	—	k Ω \parallel pF
Output: $Z_{OUT} = R_{OUT} \parallel C_{OUT}$		—	1,9 \parallel 3,5	—	k Ω \parallel pF
Temperature coefficient of frequency					
	TC_f	—	- 72	—	ppm/K

Frequency response

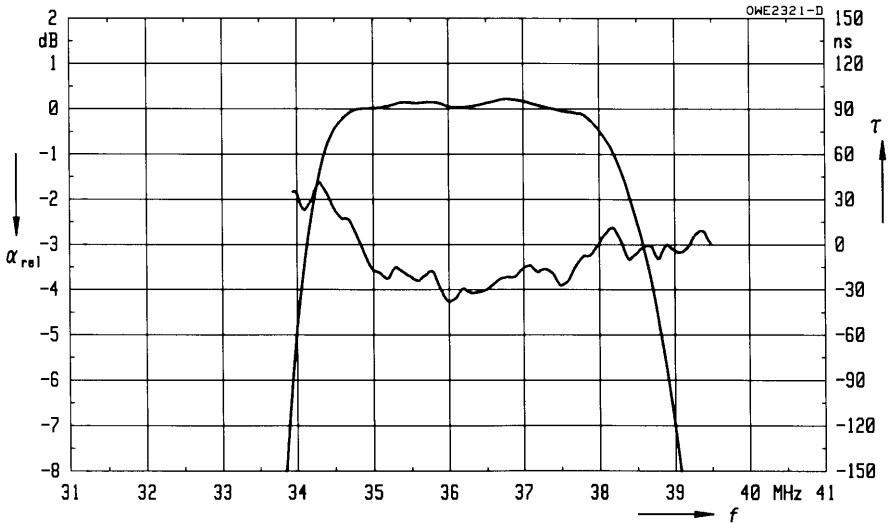
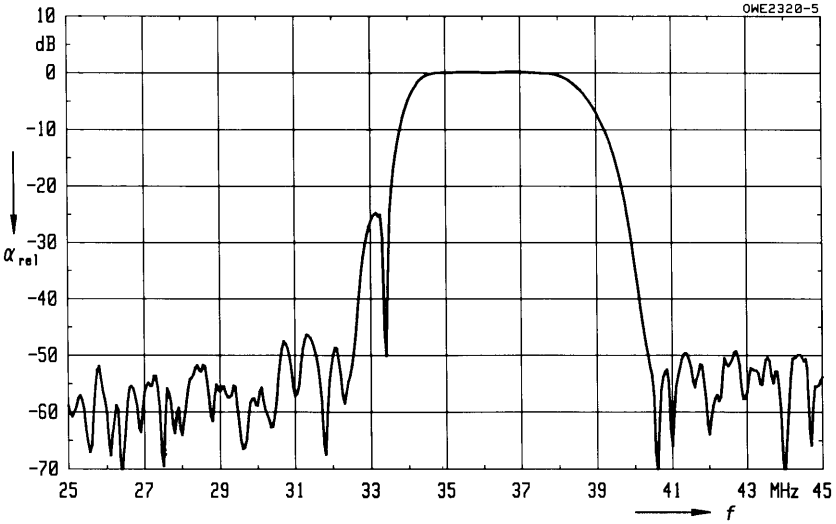

Characteristics of sound channel

Ambient temperature $T_A = 25\text{ °C}$
 Source impedance $Z_S = 50\ \Omega$
 Load impedance $Z_L = 2\text{ k}\Omega \parallel 3\text{ pF}$

		min.	typ.	max.	
Insertion attenuation	α				
Reference level for the following data	38,90 MHz	24,4	25,9	27,4	dB
Relative attenuation	α_{rel}				
Sound carrier	32,40 MHz	-2,0	-1,0	0,0	dB
	33,40 MHz	0,0	1,0	2,0	dB
	34,40 MHz	0,0	1,0	2,0	dB
NICAM sound carrier	33,05 MHz	-2,0	-1,0	0,0	dB
Adjacent picture carrier	30,90 MHz	30,0	37,0	—	dB
Adjacent sound carrier	40,40 MHz	30,0	36,0	—	dB
Lower sidelobe	25,00 ... 30,90 MHz	28,0	34,0	—	dB
Upper sidelobe	40,40 ... 45,00 MHz	28,0	34,0	—	dB
Impedance at 38,90 MHz					
Output: $Z_{OUT} = R_{OUT} \parallel C_{OUT}$		—	9,8 \parallel 2,0	—	k Ω \parallel pF
Temperature coefficient of frequency	TC_f	—	-72	—	ppm/K

Frequency response

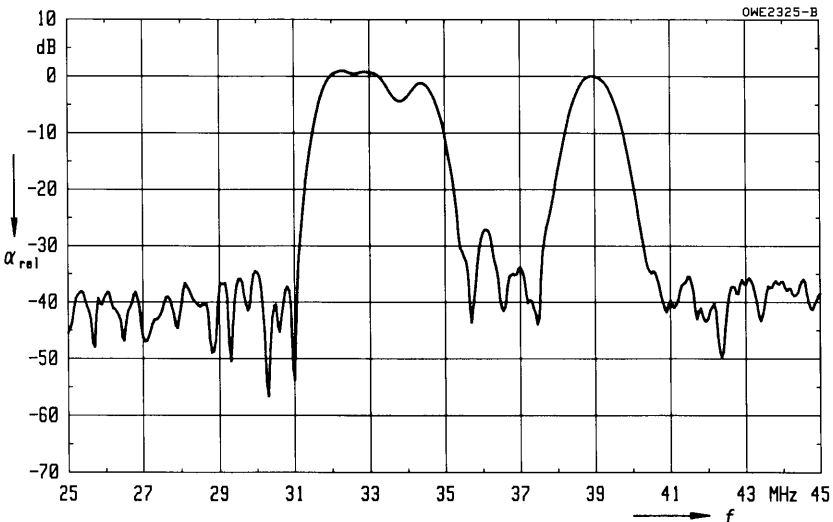

Standard

- B/G-CCIR
Germany, Europe partly
- D/K-OIRT
Eastern standard

Plastic package DIP 10 K

Features

- TV IF filter for quasi/split sound applications (separate picture and sound channel)
- Picture channel with Nyquist slope and sound suppression
- Reduced group delay predistortion as compared with standard B/G half
- Sound channel with pass band for sound carriers between 32,40 MHz and 33,40 MHz
- Suitable for CENELEC EN 55020

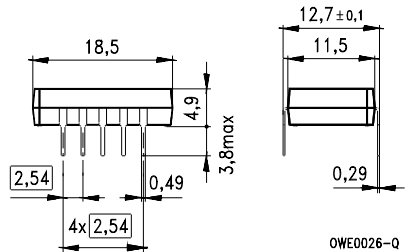
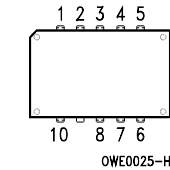

Terminals

- Tinned CuFe alloy

Dimensions in mm, approx. weight 1,8 g

Pin configuration

- 1 Input
- 2 Input – ground
- 3, 8 Chip carrier – ground
- 4, 5 Output – sound
- 6, 7 Output – picture
- 9 Free
- 10 Not connected

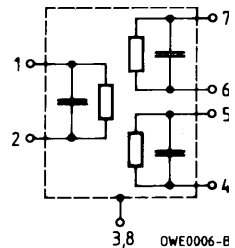

Type	Ordering code	Marking
K 3350 K	B39389-K3350-K100	Type, date code, pin 1

Maximum ratings

Ambient temperature	T_A	- 25/+ 65	°C	—
Storage temperature	T_{stg}	- 25/+ 85	°C	—
DC voltage	V_{DC}	12	V	between any terminals
AC voltage	V_{pp}	10	V	between any terminals

Characteristics of picture channel

Ambient temperature $T_A = 25\text{ }^\circ\text{C}$
 Source impedance $Z_S = 50\text{ }\Omega$
 Load impedance $Z_L = 2\text{ k}\Omega \parallel 3\text{ pF}$

		min.	typ.	max.	
Insertion attenuation					
	α				
Reference level for the following data	37,40 MHz	13,6	15,1	16,6	dB
Relative attenuation					
	α_{rel}				
Picture carrier	38,90 MHz	5,6	6,6	7,6	dB
Color carrier	34,47 MHz	0,0	1,0	2,0	dB
Sound carrier	33,40 MHz	34,0	43,0	—	dB
Adjacent picture carrier	UHF 30,90 MHz	45,0	53,0	—	dB
	VHF 31,90 MHz	47,0	57,0	—	dB
	31,40 MHz	—	60,0	—	dB
	32,40 MHz	47,0	55,0	—	dB
	40,15 MHz	43,0	59,0	—	dB
Adjacent sound carrier	VHF 40,40 MHz	45,0	56,0	—	dB
	UHF 41,40 MHz	43,0	55,0	—	dB
Lower sidelobe	25,00 ... 31,90 MHz	39,0	44,0	—	dB
Upper sidelobe	40,40 ... 45,00 MHz	34,0	40,0	—	dB
Reflected wave signal suppression					
1,3 μs ... 6,0 μs after main pulse (test pulse: 250 ns, carrier frequency: 37,40 MHz)		42,0	52,0	—	dB
Feedthrough signal suppression					
1,2 μs ... 1,1 μs before main pulse (test pulse: 250 ns, carrier frequency: 37,40 MHz)		50,0	56,0	—	dB
Group delay predistortion					
(reference frequency 38,90 MHz)					
	$\Delta\tau$				
	36,90 MHz	—	-90	—	ns
	34,47 MHz	—	30	—	ns
Impedance at 37,40 MHz					
Input:	$Z_{IN} = R_{IN} \parallel C_{IN}$	—	1,1 \parallel 24,8	—	k Ω \parallel pF
Output:	$Z_{OUT} = R_{OUT} \parallel C_{OUT}$	—	1,6 \parallel 4,1	—	k Ω \parallel pF
Temperature coefficient of frequency					
	TC_f	—	-72	—	ppm/K

Frequency response

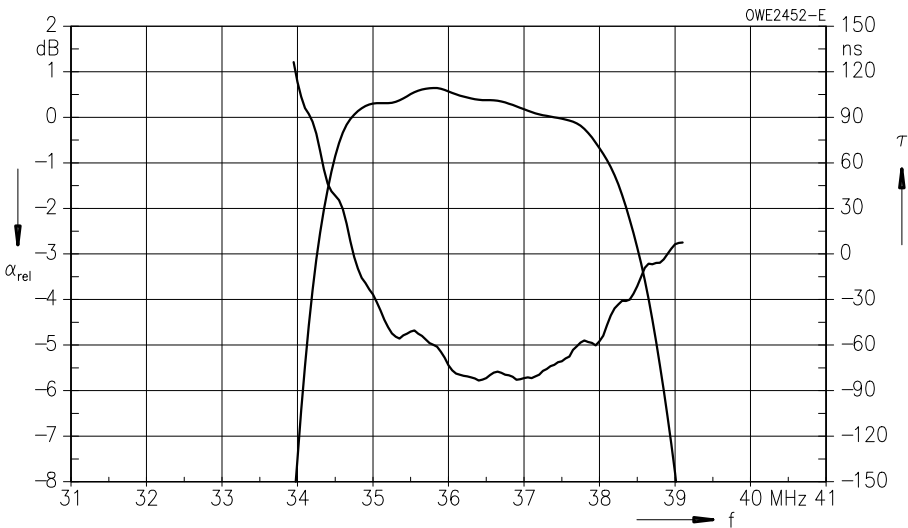
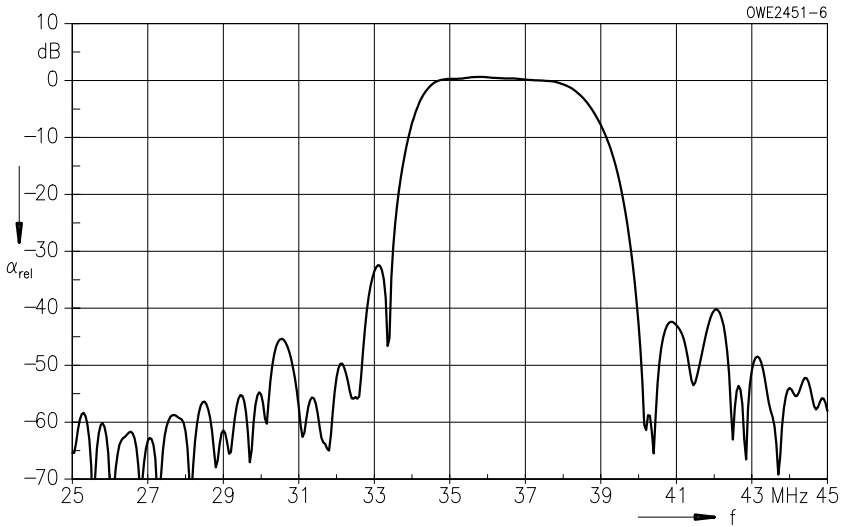

Characteristics of sound channel

Ambient temperature $T_A = 25\text{ °C}$
 Source impedance $Z_S = 50\ \Omega$
 Load impedance $Z_L = 2\text{ k}\Omega \parallel 3\text{ pF}$

		min.	typ.	max.	
Insertion attenuation					
	α				
Reference level for the following data	33,40 MHz	14,0	15,5	17,0	dB
Relative attenuation					
	α_{rel}				
Sound carrier B/G NICAM	33,05 MHz	- 1,5	- 0,5	0,5	dB
Sound carrier D/K	32,40 MHz	- 1,9	- 0,9	0,1	dB
Picture carrier	38,90 MHz	41,0	49,0	—	dB
Color carrier	34,47 MHz	28,0	34,0	—	dB
Adjacent picture carrier	30,90 MHz	36,0	43,0	—	dB
Adjacent sound carrier	40,40 MHz	44,0	52,0	—	dB
	41,40 MHz	46,0	56,0	—	dB
Lower sidelobe	25,00 ... 30,90 MHz	36,0	41,0	—	dB
Upper sidelobe	38,90 ... 45,00 MHz	41,0	48,0	—	dB
Impedance at 33,40 MHz					
	Output: $Z_{OUT} = R_{OUT} \parallel C_{OUT}$	—	3,6 2,3	—	k Ω pF
Temperature coefficient of frequency					
	TC_f	—	- 72	—	ppm/K

Frequency response

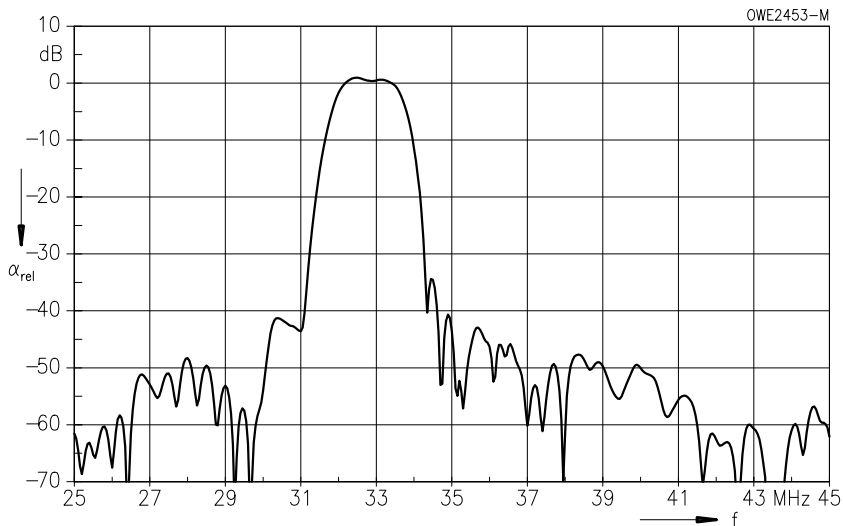

Standard

Plastic package DIP 10 K

- I
Great Britain

Features

- TV IF filter for quasi/split sound applications (separate picture and sound channel)
- Picture channel with Nyquist slope and sound suppression
- Constant group delay
- Sound channel with pass bands for picture carrier and sound carriers at 33,50 MHz and 32,95 MHz (NICAM)

Terminals

- Tinned CuFe alloy

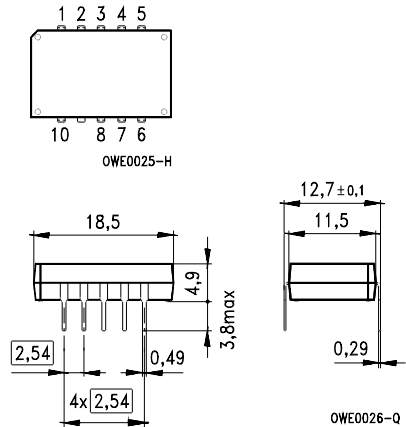

Dimensions in mm, approx. weight 1,8 g

Pin configuration

- 1 Input
- 2 Input – ground
- 3, 8 Chip carrier – ground
- 4, 5 Output – sound
- 6, 7 Output – picture
- 9 Free
- 10 Not connected

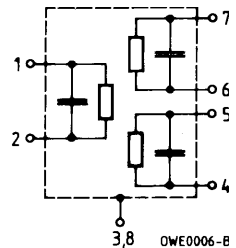

Type	Ordering code	Marking
J 3252 K	B39395-J3252-K100	Type, date code, pin 1

Maximum ratings

Ambient temperature	T_A	- 25/+ 65	°C	—
Storage temperature	T_{stg}	- 25/+ 85	°C	—
DC voltage	V_{DC}	12	V	between any terminals
AC voltage	V_{pp}	10	V	between any terminals

Characteristics of picture channel

Ambient temperature $T_A = 25\text{ °C}$
 Source impedance $Z_S = 50\ \Omega$
 Load impedance $Z_L = 2\text{ k}\Omega \parallel 3\text{ pF}$

		min.	typ.	max.	
Insertion attenuation					
	α				
Reference level for the following data	38,00 MHz	17,5	19,0	20,5	dB
Relative attenuation					
	α_{rel}				
Picture carrier	39,50 MHz	4,4	5,4	6,4	dB
Color carrier	35,07 MHz	2,2	3,2	4,2	dB
Sound carrier	33,50 MHz	46,0	59,0	—	dB
	32,95 MHz	38,0	46,0	—	dB
Adjacent picture carrier	31,50 MHz	45,0	54,0	—	dB
Adjacent sound carrier	41,50 MHz	40,0	49,0	—	dB
	40,95 MHz	36,0	43,0	—	dB
Lower sidelobe	25,00 ... 33,50 MHz	38,0	45,0	—	dB
Upper sidelobe	41,50 ... 45,00 MHz	35,0	40,0	—	dB
Reflected wave signal suppression					
1,1 μ s ... 6,0 μ s after main pulse (test pulse: 250 ns, carrier frequency: 38,00 MHz)		44,0	55,0	—	dB
Feedthrough signal suppression					
1,0 μ s ... 0,9 μ s before main pulse (test pulse: 250 ns, carrier frequency: 38,00 MHz)		—	56,0	—	dB
Group delay ripple (p-p)	$\Delta\tau$	—	40	—	ns
Impedance at 38,00 MHz					
Input: $Z_{IN} = R_{IN} \parallel C_{IN}$		—	2,2 \parallel 17,2	—	k Ω \parallel pF
Output: $Z_{OUT} = R_{OUT} \parallel C_{OUT}$		—	1,4 \parallel 4,2	—	k Ω \parallel pF
Temperature coefficient of frequency	TC_f	—	-72	—	ppm/K

Frequency response

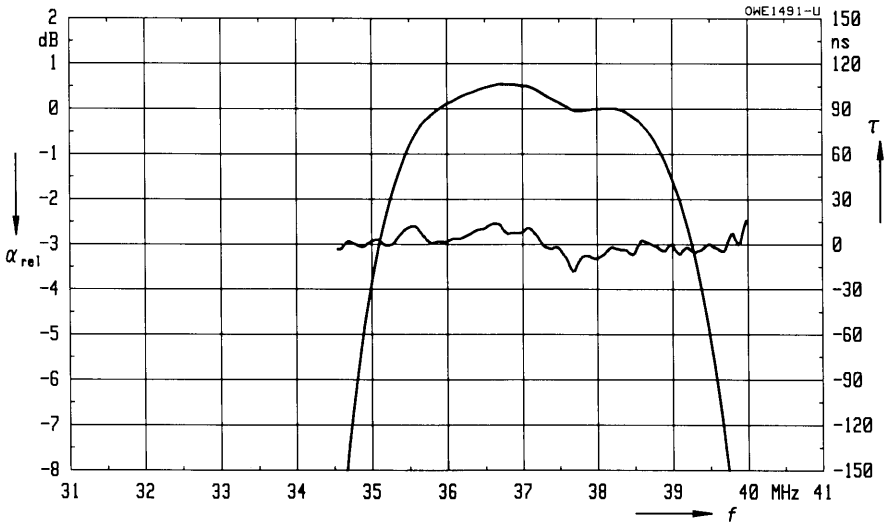
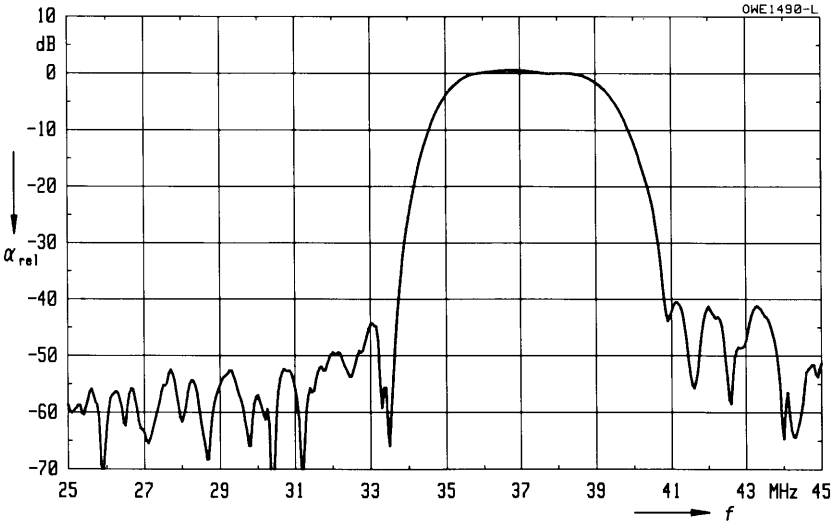

Characteristics of sound channel

Ambient temperature $T_A = 25\text{ °C}$
 Source impedance $Z_S = 50\ \Omega$
 Load impedance $Z_L = 2\text{ k}\Omega \parallel 3\text{ pF}$

		min.	typ.	max.	
Insertion attenuation	α				
Reference level for the following data	32,95 MHz	20,0	21,3	23,0	dB
Relative attenuation	α_{rel}				
Sound carrier	33,50 MHz	- 0,1	0,9	1,9	dB
	32,55 MHz	—	0,8	—	dB
	33,35 MHz	—	0,8	—	dB
Picture carrier	39,50 MHz	- 0,6	0,4	1,4	dB
	Color carrier	35,07 MHz	26,0	38,0	—
Adjacent picture carrier	31,50 MHz	30,0	38,0	—	dB
Adjacent sound carrier	41,50 MHz	26,0	33,0	—	dB
Lower sidelobe	25,00 ... 31,50 MHz	30,0	36,0	—	dB
Upper sidelobe	41,50 ... 45,00 MHz	25,0	33,0	—	dB
Impedance at 32,95 MHz					
Output: $Z_{OUT} = R_{OUT} \parallel C_{OUT}$		—	4,4 3,8	—	k Ω pF
Temperature coefficient of frequency	TC_f	—	- 72	—	ppm/K

Frequency response

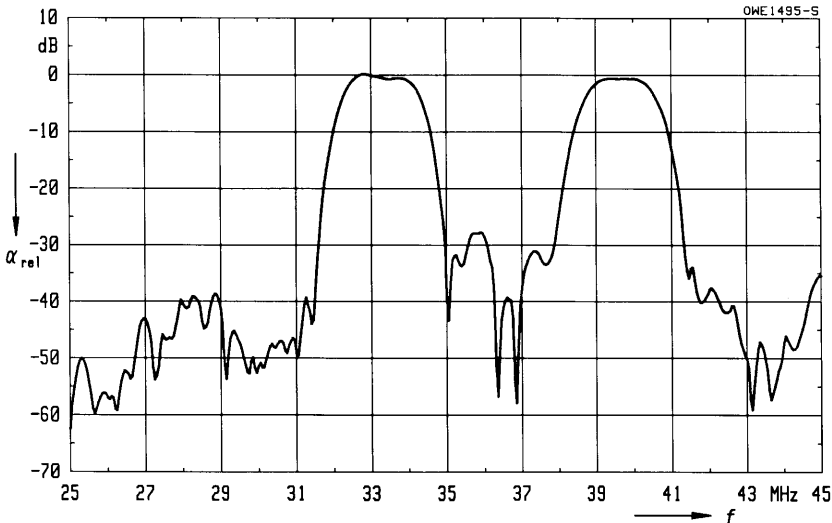

Standard

Plastic package DIP 10 K

- I
Great Britain

Features

- TV IF filter for quasi/split sound applications (separate picture and sound channel)
- Picture channel with Nyquist slope and sound suppression
- Constant group delay
- Sound channel with pass band for sound carriers at 33,50 MHz and 32,95 MHz (NICAM)
- Suitable for CENELEC EN 55020

Terminals

- Tinned CuFe alloy

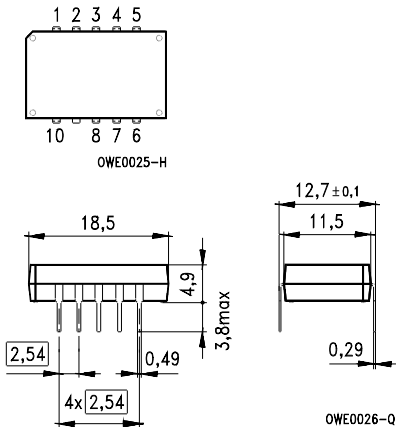

Dimensions in mm, approx. weight 1,8 g

Pin configuration

- 1 Input
- 2 Input – ground
- 3, 8 Chip carrier – ground
- 4, 5 Output – sound
- 6, 7 Output – picture
- 9 Free
- 10 Not connected

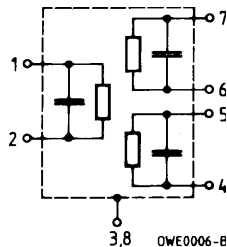

Type	Ordering code	Marking
J 3352 K	B39395-J3352-K100	Type, date code, pin 1

Maximum ratings

Ambient temperature	T_A	- 25/+ 65	°C	—
Storage temperature	T_{stg}	- 25/+ 85	°C	—
DC voltage	V_{DC}	12	V	between any terminals
AC voltage	V_{pp}	10	V	between any terminals

Characteristics of picture channel

Ambient temperature $T_A = 25\text{ °C}$
 Source impedance $Z_S = 50\ \Omega$
 Load impedance $Z_L = 2\text{ k}\Omega \parallel 3\text{ pF}$

		min.	typ.	max.	
Insertion attenuation					
	α				
Reference level for the following data	38,00 MHz	14,3	15,8	17,3	dB
Relative attenuation					
	α_{rel}				
Picture carrier	39,50 MHz	5,3	6,3	7,3	dB
Color carrier	35,07 MHz	- 0,7	0,3	1,3	dB
Sound carrier	33,50 MHz	40,0	55,0	—	dB
	32,95 MHz	40,0	51,0	—	dB
Adjacent picture carrier	31,50 MHz	48,0	60,0	—	dB
	31,00 MHz	48,0	62,0	—	dB
	32,00 MHz	50,0	60,0	—	dB
Adjacent sound carrier	41,50 MHz	46,0	59,0	—	dB
	40,95 MHz	42,0	52,0	—	dB
Lower sidelobe	25,00 ... 31,50 MHz	44,0	52,0	—	dB
Upper sidelobe	41,50 ... 45,00 MHz	40,0	46,0	—	dB
Reflected wave signal suppression					
1,2 μ s ... 6,0 μ s after main pulse (test pulse: 250 ns, carrier frequency: 38,00 MHz)		42,0	54,0	—	dB
Feedthrough signal suppression					
1,3 μ s ... 1,2 μ s before main pulse (test pulse: 250 ns, carrier frequency: 38,00 MHz)		—	56,0	—	dB
Group delay ripple (p-p)					
	$\Delta\tau$	—	30	—	ns
Impedance at 38,00 MHz					
	Input: $Z_{IN} = R_{IN} \parallel C_{IN}$	—	1,0 \parallel 28,3	—	k Ω \parallel pF
	Output: $Z_{OUT} = R_{OUT} \parallel C_{OUT}$	—	2,7 \parallel 3,3	—	k Ω \parallel pF
Temperature coefficient of frequency					
	TC_f	—	- 72	—	ppm/K

Frequency response

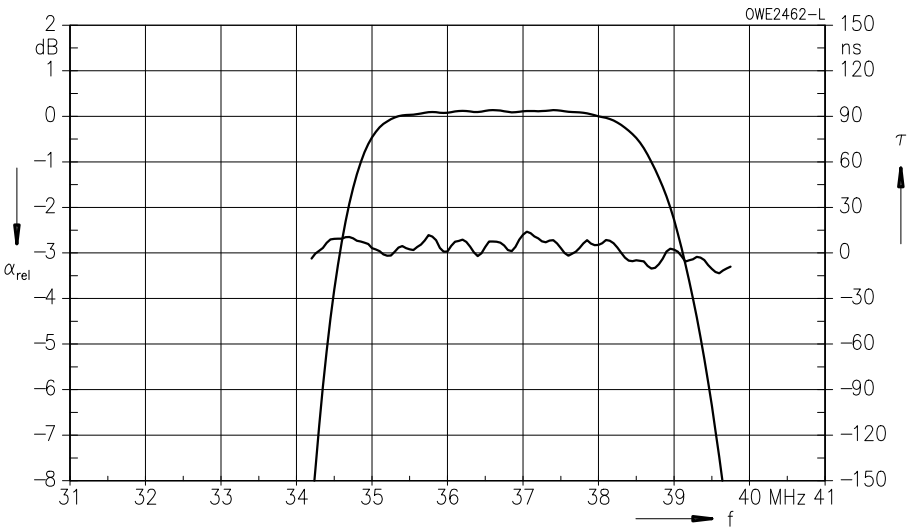
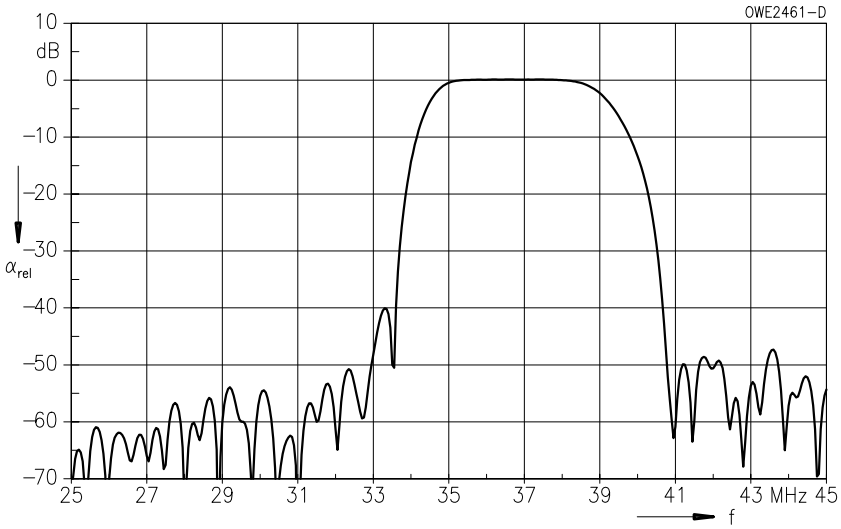

Characteristics of sound channel

Ambient temperature $T_A = 25\text{ }^\circ\text{C}$
 Source impedance $Z_S = 50\text{ }\Omega$
 Load impedance $Z_L = 2\text{ k}\Omega \parallel 3\text{ pF}$

		min.	typ.	max.	
Insertion attenuation	α				
Reference level for the following data	32,95 MHz	10,1	11,6	13,1	dB
Relative attenuation	α_{rel}				
Sound carrier	33,50 MHz	- 0,7	0,3	1,3	dB
Picture carrier	39,50 MHz	46,0	60,0	—	dB
Color carrier	35,07 MHz	30,0	45,0	—	dB
Adjacent picture carrier	31,50 MHz	40,0	52,0	—	dB
Adjacent sound carrier	41,50 MHz	50,0	62,0	—	dB
	40,95 MHz	45,0	56,0	—	dB
Lower sidelobe	25,00 ... 31,50 MHz	36,0	42,0	—	dB
Upper sidelobe	39,50 ... 45,00 MHz	44,0	52,0	—	dB
Impedance at 32,95 MHz					
Output: $Z_{OUT} = R_{OUT} \parallel C_{OUT}$		—	2,6 \parallel 3,3	—	k Ω \parallel pF
Temperature coefficient of frequency	TC_f	—	- 72	—	ppm/K

Frequency response

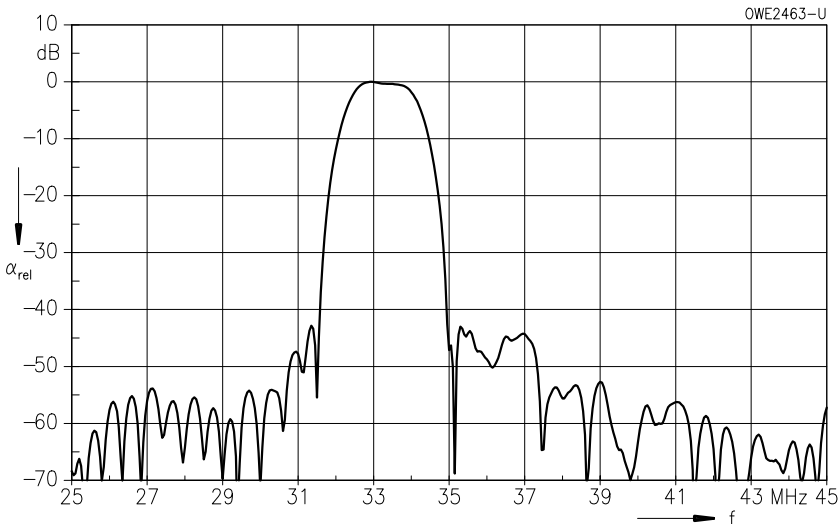

Standard

- M/N-FCC
USA

Plastic package **DIP 10 K**

Features

- TV IF filter for quasi/split sound applications (separate picture and sound channel)
- Picture channel with Nyquist slope and sound suppression
- Constant group delay
- Sound channel with pass bands for picture carrier and sound carrier
- Phase shift between picture and sound channel optimized for twin PLL ICs
- Suitable for FCC EIA/IS-31 regulations

Terminals

- Tinned CuFe alloy

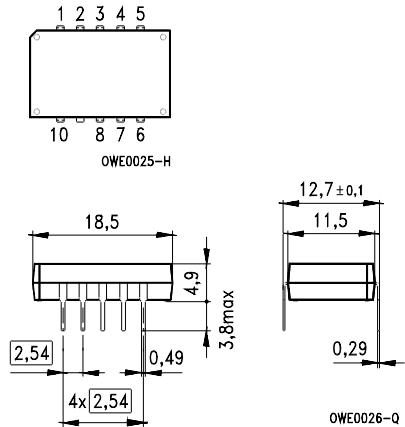

Dimensions in mm, approx. weight 1,8 g

Pin configuration

- 1 Input
- 2 Input – ground
- 3, 8 Chip carrier – ground
- 4, 5 Output – sound
- 6, 7 Output – picture
- 9 Free
- 10 Not connected

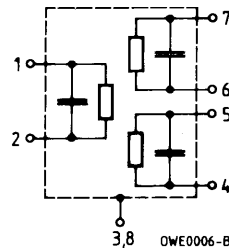

Type	Ordering code	Marking
M 3271 K	B39458-M3271-K100	Type, date code, pin 1

Maximum ratings

Ambient temperature	T_A	- 25/+ 65	°C	—
Storage temperature	T_{stg}	- 25/+ 85	°C	—
DC voltage	V_{DC}	12	V	between any terminals
AC voltage	V_{pp}	10	V	between any terminals

Characteristics of picture channel

Ambient temperature $T_A = 25 (45)^\circ\text{C}$
 Source impedance $Z_S = 50 \Omega$
 Load impedance $Z_L = 2 \text{ k}\Omega \parallel 3 \text{ pF}$

		min.	typ.	max.	
Insertion attenuation					α
Reference level for the following data	44,06 (44,00) MHz	12,4	13,9	15,4	dB
Relative attenuation					α_{rel}
Picture carrier	45,81 (45,75) MHz	5,6	6,6	7,6	dB
Color carrier	42,23 (42,17) MHz	- 0,9	0,1	1,1	dB
	41,73 (41,67) MHz	3,9	5,4	6,9	dB
Sound carrier	41,31 (41,25) MHz	20,0	29,0	—	dB
Adjacent picture carrier	39,81 (39,75) MHz	46,0	54,0	—	dB
Adjacent sound carrier	47,31 (47,25) MHz	44,0	58,0	—	dB
Lower sidelobe					
	35,06 ... 39,81 (35,00 ... 39,75) MHz	40,0	46,0	—	dB
Upper sidelobe					
	47,31 ... 55,06 (47,25 ... 55,00) MHz	37,0	43,0	—	dB
Reflected wave signal suppression					
1,2 μs ... 6,0 μs after main pulse (test pulse: 250 ns, carrier frequency: 44,06 MHz)		42,0	50,0	—	dB
Feedthrough signal suppression					
1,3 μs ... 1,2 μs before main pulse (test pulse: 250 ns, carrier frequency: 44,06 MHz)		—	56,0	—	dB
Phase difference referred to sound channel at 45,81 (45,75) MHz		$\Delta\varphi$			
		55,0	60,0	65,0	$^\circ$
Group delay ripple (p-p)		$\Delta\tau$			
		—	60	—	ns
Impedance at 44,06 MHz					
	Input: $Z_{\text{IN}} = R_{\text{IN}} \parallel C_{\text{IN}}$	—	0,9 \parallel 25,0	—	k Ω \parallel pF
	Output: $Z_{\text{OUT}} = R_{\text{OUT}} \parallel C_{\text{OUT}}$	—	1,0 \parallel 3,7	—	k Ω \parallel pF
Temperature coefficient of frequency		TC_f			
		—	- 72	—	ppm/K

M 3271 K
45,75 MHz

Frequency response

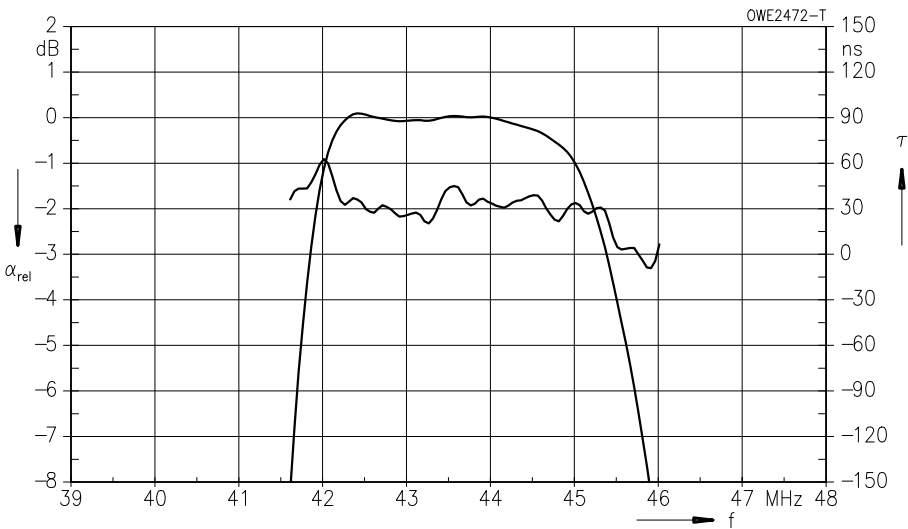
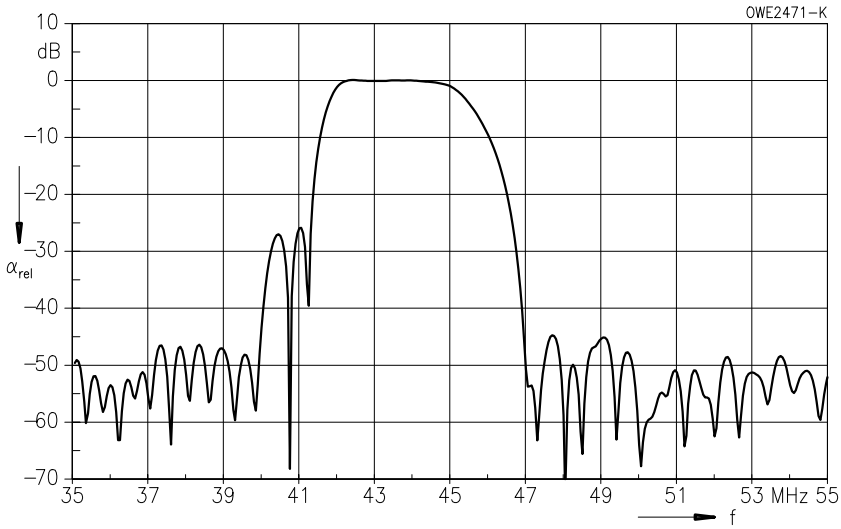

Characteristics of sound channel

Ambient temperature $T_A = 25 (45) \text{ }^\circ\text{C}$
 Source impedance $Z_S = 50 \text{ } \Omega$
 Load impedance $Z_L = 2 \text{ k}\Omega \parallel 3 \text{ pF}$

		min.	typ.	max.	
Insertion attenuation α					
Reference level for the following data	45,81 (45,75) MHz	17,6	19,1	20,6	dB
Relative attenuation α_{rel}					
Sound carrier	41,31 (41,25) MHz	- 2,6	- 1,1	0,4	dB
Color carrier	42,23 (42,17) MHz	22,0	31,0	—	dB
Adjacent picture carrier	39,81 (39,75) MHz	40,0	54,0	—	dB
Adjacent sound carrier	47,31 (47,25) MHz	36,0	46,0	—	dB
Lower sidelobe					
	35,06 ... 39,81 (35,00 ... 39,75) MHz	36,0	43,0	—	dB
Upper sidelobe					
	47,31 ... 55,06 (47,25 ... 55,00) MHz	32,0	38,0	—	dB
Impedance at 45,81 MHz					
	Output: $Z_{OUT} = R_{OUT} \parallel C_{OUT}$	—	5,3 \parallel 1,7	—	k Ω \parallel pF
Temperature coefficient of frequency TC_f		—	- 72	—	ppm/K

Frequency response

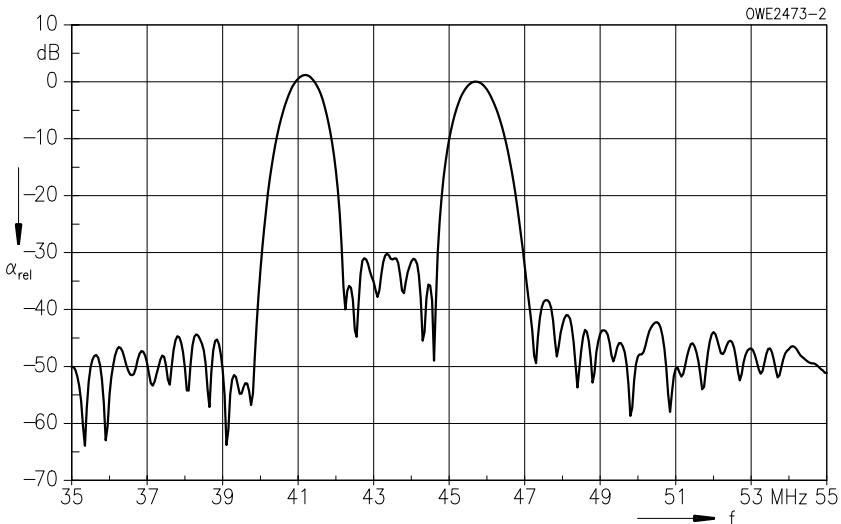

Standard

Plastic package DIP 10 K

- M/N-FCC
USA

Features

- TV IF filter for quasi/split sound applications (separate picture and sound channel)
- Picture channel with Nyquist slope and sound suppression
- Constant group delay
- Sound channel with pass band for sound carrier
- Suitable for FCC EIA/IS-31 regulations

Terminals

- Tinned CuFe alloy

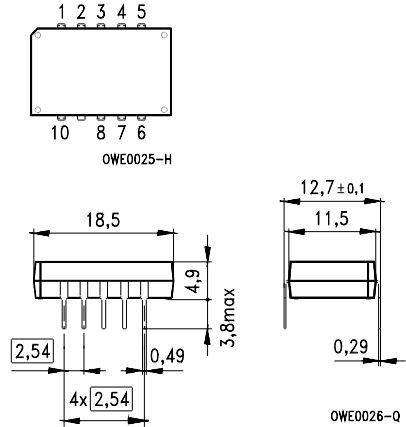

Dimensions in mm, approx. weight 1,8 g

Pin configuration

- 1 Input
- 2 Input – ground
- 3, 8 Chip carrier – ground
- 4, 5 Output – sound
- 6, 7 Output – picture
- 9 Free
- 10 Not connected

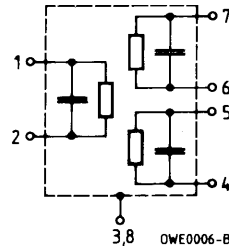

Type	Ordering code	Marking
M 3354 K	B39458-M3354-K100	Type, date code, pin 1

Maximum ratings

Ambient temperature	T_A	- 25/+ 65	°C	—
Storage temperature	T_{stg}	- 25/+ 85	°C	—
DC voltage	V_{DC}	12	V	between any terminals
AC voltage	V_{pp}	10	V	between any terminals

Characteristics of picture channel

Ambient temperature $T_A = 25 (45) \text{ }^\circ\text{C}$
 Source impedance $Z_S = 50 \text{ } \Omega$
 Load impedance $Z_L = 2 \text{ k}\Omega \parallel 3 \text{ pF}$

		min.	typ.	max.	
Insertion attenuation α					
Reference level for the following data	44,06 (44,00) MHz	13,5	15,0	16,5	dB
Relative attenuation α_{rel}					
Picture carrier	45,81 (45,75) MHz	4,6	5,6	6,6	dB
Color carrier	42,23 (42,17) MHz	- 1,4	- 0,4	0,6	dB
	41,73 (41,67) MHz	4,5	5,5	6,5	dB
Sound carrier	41,31 (41,25) MHz	25,0	32,0	—	dB
Adjacent picture carrier	39,81 (39,75) MHz	46,0	56,0	—	dB
Adjacent sound carrier	47,31 (47,25) MHz	44,0	51,0	—	dB
Lower sidelobe					
	35,06 ... 39,81 (35,00 ... 39,75) MHz	35,0	40,0	—	dB
Upper sidelobe					
	47,31 ... 55,06 (47,25 ... 55,00) MHz	38,0	44,0	—	dB
Reflected wave signal suppression					
1,2 μs ... 6,0 μs after main pulse (test pulse: 250 ns, carrier frequency: 44,06 MHz)		42,0	52,0	—	dB
Feedthrough signal suppression					
1,3 μs ... 1,2 μs before main pulse (test pulse: 250 ns, carrier frequency: 44,06 MHz)		—	56,0	—	dB
Group delay ripple (p-p) $\Delta\tau$		—	50	—	ns
Impedance at 44,06 MHz					
Input: $Z_{IN} = R_{IN} \parallel C_{IN}$		—	1,3 \parallel 19,7	—	k Ω \parallel pF
Output: $Z_{OUT} = R_{OUT} \parallel C_{OUT}$		—	1,0 \parallel 3,9	—	k Ω \parallel pF
Temperature coefficient of frequency TC_f		—	- 72	—	ppm/K

M 3354 K
45,75 MHz

Frequency response

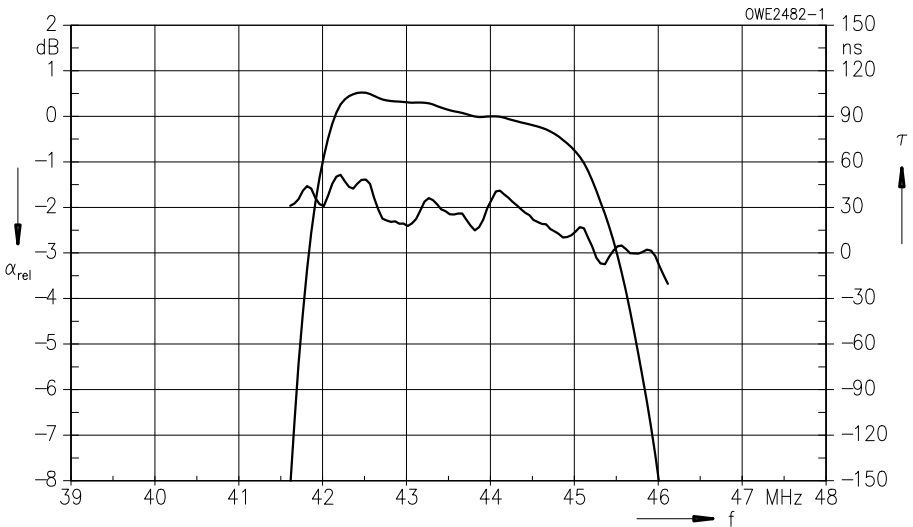
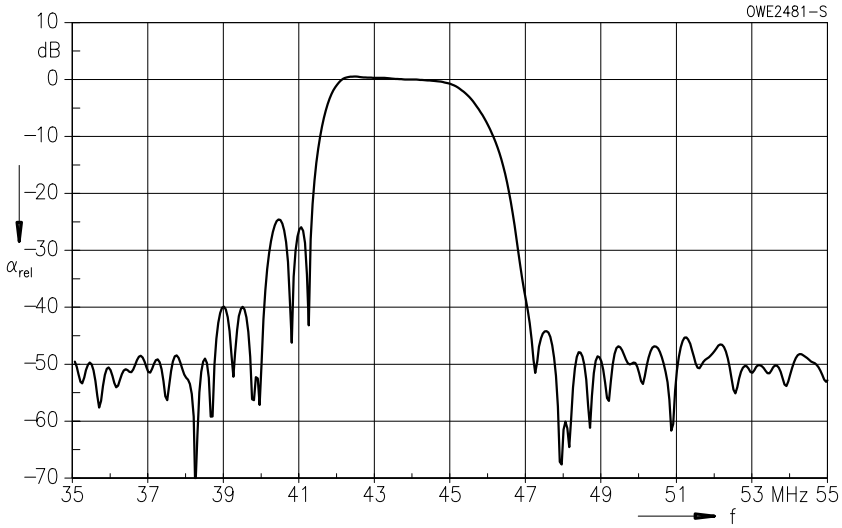

Characteristics of sound channel

Ambient temperature $T_A = 25 (45) \text{ }^\circ\text{C}$
 Source impedance $Z_S = 50 \text{ } \Omega$
 Load impedance $Z_L = 2 \text{ k}\Omega \parallel 3 \text{ pF}$

		min.	typ.	max.	
Insertion attenuation α					
Reference level for the following data	41,31 (41,25) MHz	12,3	13,8	15,3	dB
Relative attenuation α_{rel}					
Picture carrier	45,81 (45,75) MHz	42,0	53,0	—	dB
Color carrier	42,23 (42,17) MHz	25,0	33,0	—	dB
Adjacent picture carrier	39,81 (39,75) MHz	40,0	47,0	—	dB
Adjacent sound carrier	47,31 (47,25) MHz	40,0	47,0	—	dB
Lower sidelobe					
	35,06 ... 39,81 (35,00 ... 39,75) MHz	30,0	34,0	—	dB
Upper sidelobe					
	47,31 ... 55,06 (47,25 ... 55,00) MHz	38,0	45,0	—	dB
Impedance at 41,31 MHz					
	Output: $Z_{OUT} = R_{OUT} \parallel C_{OUT}$	—	2,0 \parallel 2,8	—	k Ω \parallel pF
Temperature coefficient of frequency TC_f		—	-72	—	ppm/K

Frequency response

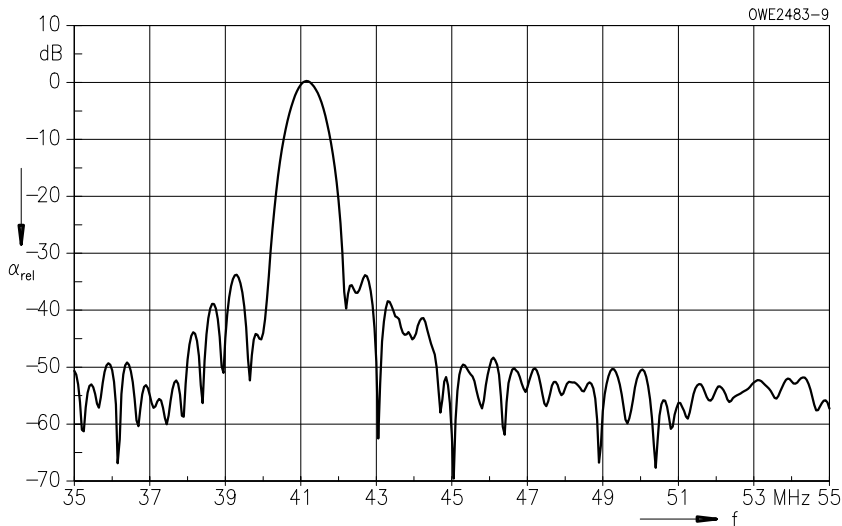

Standard

- M/N-FCC
USA

Features

- TV IF filter for quasi/split sound applications (separate picture and sound channel)
- Picture channel with Nyquist slope and sound suppression, symmetrical output
- Constant group delay
- Sound channel with pass bands for sound carrier

Terminals

- Tinned CuFe alloy

Plastic package **SIP 5 K**

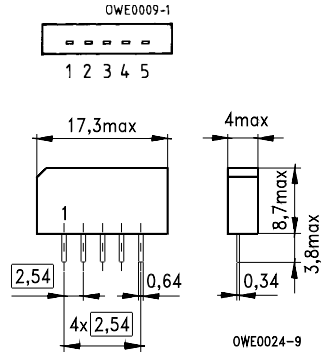

Dimensions in mm, approx. weight 1,0 g

Pin configuration

- 1 Input
- 2 Chip carrier – ground
- 3 Output – sound
- 4 Output – picture
- 5 Output – picture

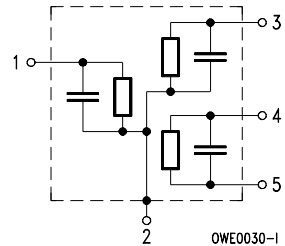

Type	Ordering code	Marking
M 3561 M	B39458-M3561-M201	Type, date code, pin 1

Maximum ratings

Ambient temperature	T_A	- 25/+ 65	°C	—
Storage temperature	T_{stg}	- 25/+ 85	°C	—
DC voltage	V_{DC}	12	V	between any terminals
AC voltage	V_{pp}	10	V	between any terminals

Characteristics of picture channel

Ambient temperature $T_A = 25 (45) \text{ }^\circ\text{C}$
 Source impedance $Z_S = 50 \text{ } \Omega$
 Load impedance $Z_L = 2 \text{ k}\Omega \parallel 3 \text{ pF}$

		min.	typ.	max.	
Insertion attenuation α					
Reference level for the following data	44,06 (44,00) MHz	12,2	13,7	15,2	dB
Relative attenuation α_{rel}					
Picture carrier	45,81 (45,75) MHz	4,9	5,9	6,9	dB
Color carrier	42,23 (42,17) MHz	1,2	2,2	3,2	dB
Sound carrier	41,31 (41,25) MHz	28,0	34,0	—	dB
Adjacent picture carrier	39,81 (39,75) MHz	46,0	59,0	—	dB
Adjacent sound carrier	47,31 (47,25) MHz	42,0	54,0	—	dB
Lower sidelobe					
	35,06 ... 39,81 (35,00 ... 39,75) MHz	43,0	51,0	—	dB
Upper sidelobe					
	47,31 ... 55,06 (47,25 ... 55,00) MHz	38,0	44,0	—	dB
Reflected wave signal suppression					
1,2 μs ... 6,0 μs after main pulse (test pulse: 250 ns, carrier frequency: 44,06 MHz)		42,0	54,0	—	dB
Feedthrough signal suppression					
1,3 μs ... 1,2 μs before main pulse (test pulse: 250 ns, carrier frequency: 44,06 MHz)		—	56,0	—	dB
Group delay ripple (p-p)	$\Delta\tau$	—	50	—	ns
Impedance at 44,06 MHz					
Input: $Z_{IN} = R_{IN} \parallel C_{IN}$		—	1,0 \parallel 20,2	—	k Ω \parallel pF
Output: $Z_{OUT} = R_{OUT} \parallel C_{OUT}$		—	1,0 \parallel 4,1	—	k Ω \parallel pF
Temperature coefficient of frequency	TC_f	—	-72	—	ppm/K

M 3561 M
45,75 MHz

Frequency response

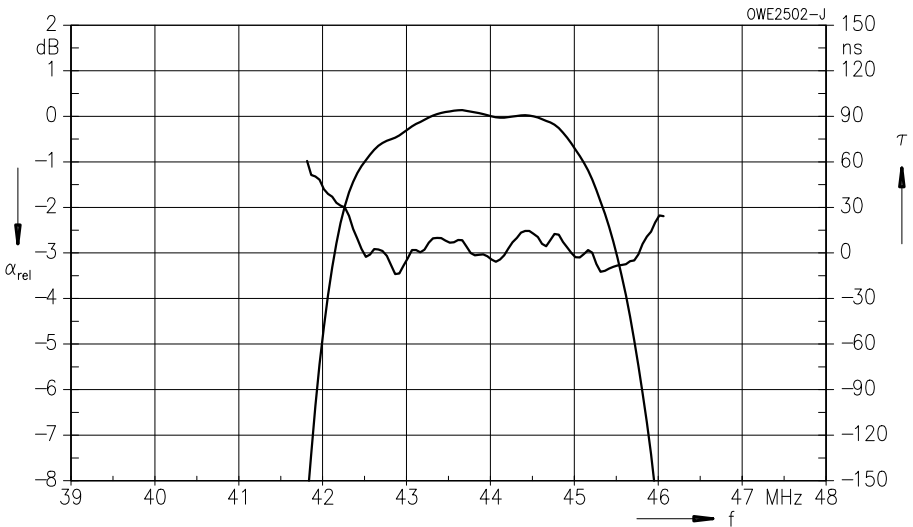
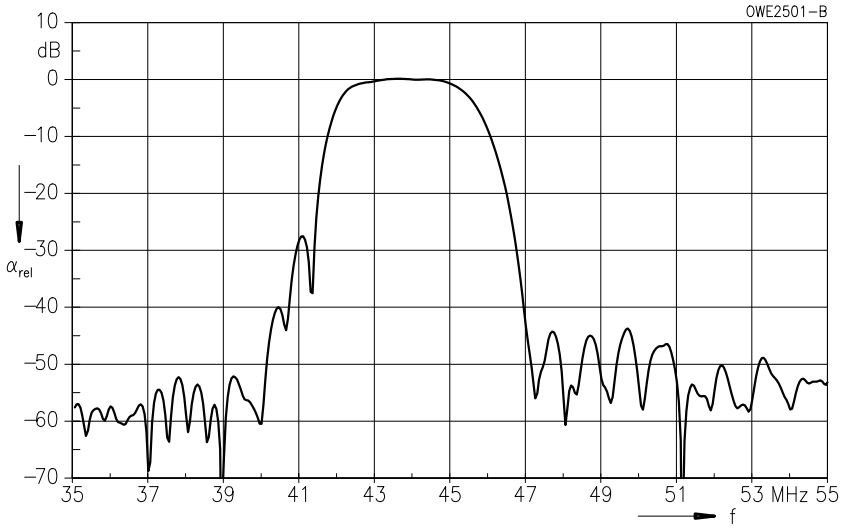

Characteristics of sound channel

Ambient temperature $T_A = 25 (45) \text{ }^\circ\text{C}$
 Source impedance $Z_S = 50 \text{ } \Omega$
 Load impedance $Z_L = 2 \text{ k}\Omega \parallel 3 \text{ pF}$

		min.	typ.	max.	
Insertion attenuation α					
Reference level for the following data	41,31 (41,25) MHz	14,6	16,1	17,6	dB
Relative attenuation α_{rel}					
Picture carrier	45,81 (45,75) MHz	33,0	43,0	—	dB
Color carrier	42,23 (42,17) MHz	16,0	21,0	—	dB
Adjacent picture carrier	39,81 (39,75) MHz	27,0	33,0	—	dB
Adjacent sound carrier	47,31 (47,25) MHz	33,0	43,0	—	dB
Lower sidelobe					
	35,06 ... 39,81 (35,00 ... 39,75) MHz	23,0	28,0	—	dB
Upper sidelobe					
	47,31 ... 55,06 (47,25 ... 55,00) MHz	30,0	35,0	—	dB
Impedance at 41,31 MHz					
	Output: $Z_{OUT} = R_{OUT} \parallel C_{OUT}$	—	2,1 \parallel 5,3	—	k Ω \parallel pF
Temperature coefficient of frequency TC_f		—	-72	—	ppm/K

Frequency response

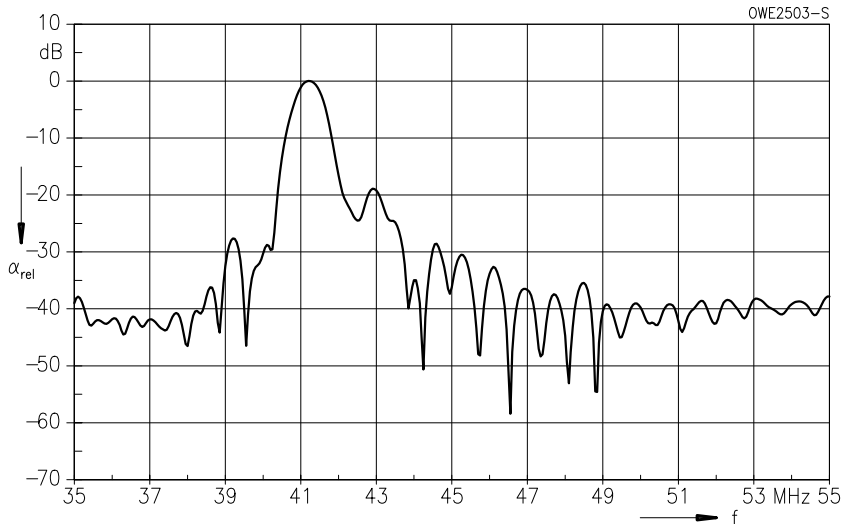

Standard

- M/N-FCC
USA

Plastic package **DIP 10 K**

Features

- TV IF filter for quasi/split sound applications (separate picture and sound channel)
- Picture channel with Nyquist slope and sound suppression
- High color carrier level
- Customized group delay predistortion
- Sound channel with pass band for sound carrier
- Suitable for FCC EIA/IS-31 regulations

Terminals

- Tinned CuFe alloy

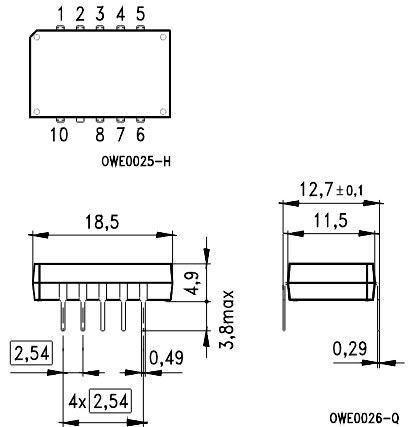

Dimensions in mm, approx. weight 1,8 g

Pin configuration

- 1 Input
- 2 Input – ground
- 3, 8 Chip carrier – ground
- 4, 5 Output – sound
- 6, 7 Output – picture
- 9 Free
- 10 Input – picture

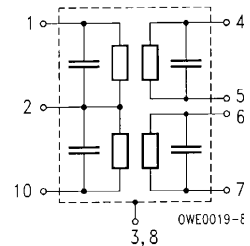

Type	Ordering code	Marking
M 3654 K	B39458-M3654-K100	Type, date code, pin 1

Maximum ratings

Ambient temperature	T_A	- 25/+ 65	°C	—
Storage temperature	T_{stg}	- 25/+ 85	°C	—
DC voltage	V_{DC}	12	V	between any terminals
AC voltage	V_{pp}	10	V	between any terminals

Characteristics of picture channel

Ambient temperature $T_A = 25 (45) \text{ }^\circ\text{C}$
 Source impedance $Z_S = 50 \text{ } \Omega$
 Load impedance $Z_L = 2 \text{ k}\Omega \parallel 3 \text{ pF}$

		min.	typ.	max.	
Insertion attenuation α					
Reference level for the following data	44,06 (44,00) MHz	12,3	13,8	15,3	dB
Relative attenuation α_{rel}					
Picture carrier	45,81 (45,75) MHz	5,3	6,0	6,7	dB
Color carrier	42,23 (42,17) MHz	- 0,5	0,5	1,5	dB
Sound carrier	41,31 (41,25) MHz	25,0	39,0	—	dB
Adjacent picture carrier	39,81 (39,75) MHz	45,0	56,0	—	dB
Adjacent sound carrier	47,31 (47,25) MHz	44,0	51,0	—	dB
Lower sidelobe					
	35,06 ... 39,81 (35,00 ... 39,75) MHz	37,0	41,0	—	dB
Upper sidelobe					
	47,31 ... 55,06 (47,25 ... 55,00) MHz	37,0	52,0	—	dB
Reflected wave signal suppression					
1,2 μ s ... 6,0 μ s after main pulse (test pulse: 250 ns, carrier frequency: 44,06 MHz)		42,0	42,0	—	dB
Feedthrough signal suppression					
1,2 μ s ... 1,1 μ s before main pulse (test pulse: 250 ns, carrier frequency: 44,06 MHz)		50,0	56,0	—	dB
Group delay predistortion $\Delta\tau$					
(reference frequency 45,81 MHz)					
	42,23 (42,17) MHz	—	- 40	—	ns
Impedance at 44,06 MHz					
Input: $Z_{IN} = R_{IN} \parallel C_{IN}$		—	1,2 \parallel 12,4	—	k Ω \parallel pF
Output: $Z_{OUT} = R_{OUT} \parallel C_{OUT}$		—	1,2 \parallel 3,5	—	k Ω \parallel pF
Temperature coefficient of frequency TC_f					
		—	- 72	—	ppm/K

M 3654 K
45,75 MHz

Frequency response

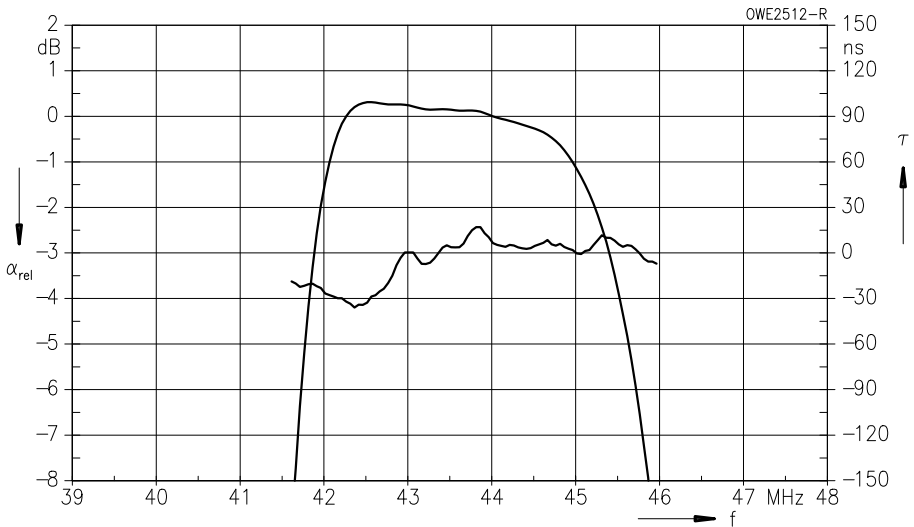
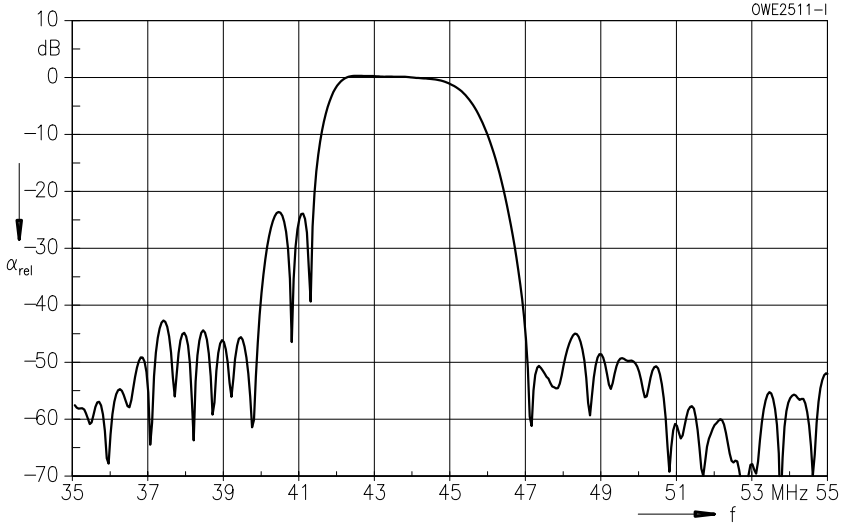

Characteristics of sound channel

Ambient temperature $T_A = 25 (45) \text{ }^\circ\text{C}$
 Source impedance $Z_S = 50 \text{ } \Omega$
 Load impedance $Z_L = 2 \text{ k}\Omega \parallel 3 \text{ pF}$

		min.	typ.	max.	
Insertion attenuation					
Reference level for the following data	41,31 (41,25) MHz	10,5	12,0	13,5	dB
Pass bandwidth					
$\alpha_{\text{rel}} \leq 3 \text{ dB}$	$B_{3\text{dB}}$	—	0,6	—	MHz
$\alpha_{\text{rel}} \leq 20 \text{ dB}$	$B_{20\text{dB}}$	—	1,35	—	MHz
Relative attenuation					
Picture carrier	45,81 (45,75) MHz	45,0	55,0	—	dB
Color carrier	42,23 (42,17) MHz	22,0	26,0	—	dB
Adjacent picture carrier	39,81 (39,75) MHz	40,0	47,0	—	dB
Adjacent sound carrier	47,31 (47,25) MHz	43,0	52,0	—	dB
Lower sidelobe					
	35,06 ... 39,06 (35,00 ... 39,00) MHz	34,0	38,0	—	dB
	39,06 ... 39,41 (39,00 ... 39,35) MHz	36,0	42,0	—	dB
Upper sidelobe					
	47,31 ... 55,06 (47,25 ... 55,00) MHz	42,0	48,0	—	dB
Group delay ripple (p-p)					
	41,01 ... 41,61 (40,95 ... 41,55) MHz	—	80	—	ns
Impedance at 41,31 MHz					
	Input: $Z_{\text{IN}} = R_{\text{IN}} \parallel C_{\text{IN}}$	—	0,6 \parallel 14,2	—	k Ω \parallel pF
	Output: $Z_{\text{OUT}} = R_{\text{OUT}} \parallel C_{\text{OUT}}$	—	2,8 \parallel 2,4	—	k Ω \parallel pF
Temperature coefficient of frequency					
	TC_f	—	- 72	—	ppm/K

M 3654 K
45,75 MHz

Frequency response

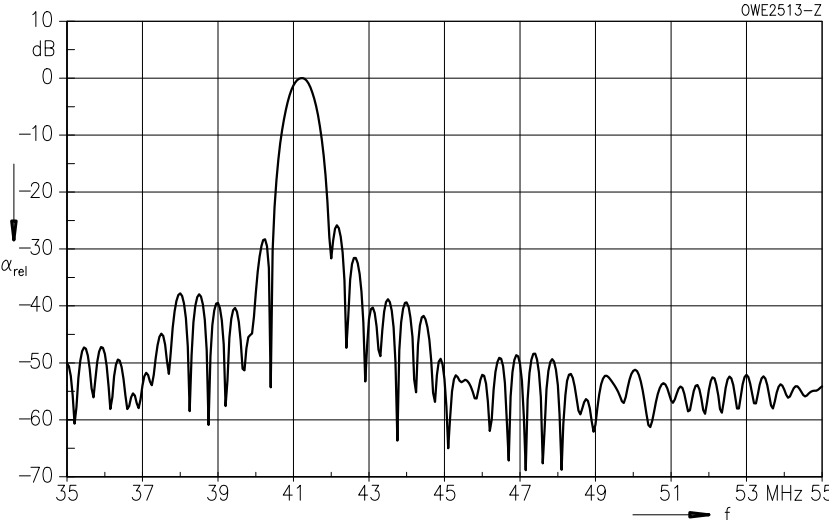

Standard

- M
Japan

Features

- TV IF filter for quasi/split sound applications (separate picture and sound channel)
- Picture channel with Nyquist slope and sound suppression, symmetrical output
- Constant group delay
- Sound channel with pass band for sound carrier

Terminals

- Tinned CuFe alloy

Plastic package **SIP 5 K**

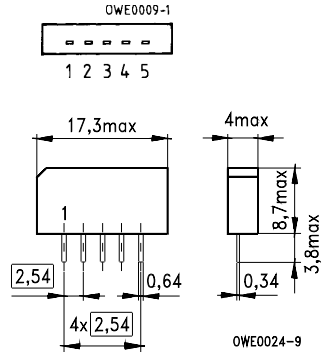

Dimensions in mm, approx. weight 1,0 g

Pin configuration

- 1 Input
- 2 Chip carrier – ground
- 3 Output – sound
- 4 Output – picture
- 5 Output – picture

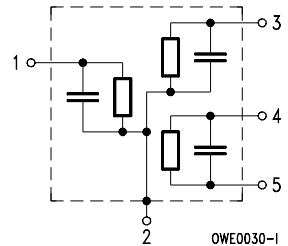

Type	Ordering code	Marking
N 3561 M	B39588-N3561-M201	Type, date code, pin 1

Maximum ratings

Ambient temperature	T_A	- 25/+ 65	°C	—
Storage temperature	T_{stg}	- 25/+ 85	°C	—
DC voltage	V_{DC}	12	V	between any terminals
AC voltage	V_{pp}	10	V	between any terminals

N 3561 M

58,75 MHz

Characteristics of picture channel

Ambient temperature	$T_A = 25 (45) \text{ }^\circ\text{C}$
Source impedance	$Z_S = 50 \text{ } \Omega$
Load impedance	$Z_L = 2 \text{ k}\Omega \parallel 3 \text{ pF}$

		min.	typ.	max.	
Insertion attenuation					
	α				
Reference level for the following data	57,08 (57,00) MHz	13,0	14,5	16,0	dB
Relative attenuation					
	α_{rel}				
Picture carrier	58,83 (58,75) MHz	5,1	6,1	7,1	dB
Color carrier	55,25 (55,17) MHz	- 0,7	0,3	1,3	dB
Sound carrier	54,33 (54,25) MHz	22,0	29,0	—	dB
Adjacent picture carrier	52,83 (52,75) MHz	44,0	52,0	—	dB
Adjacent sound carrier	60,33 (60,25) MHz	40,0	50,0	—	dB
Lower sidelobe					
	45,08 ... 52,83 (45,00 ... 52,75) MHz	37,0	43,0	—	dB
Upper sidelobe					
	60,33 ... 65,08 (60,25 ... 65,00) MHz	37,0	43,0	—	dB
Reflected wave signal suppression					
1,2 μs ... 6,0 μs after main pulse (test pulse: 250 ns, carrier frequency: 57,08 MHz)		42,0	51,0	—	dB
Feedthrough signal suppression					
1,3 μs ... 1,2 μs before main pulse (test pulse: 250 ns, carrier frequency: 57,08 MHz)		—	56,0	—	dB
Group delay ripple (p-p)	$\Delta\tau$	—	50	—	ns
Impedance at 57,08 MHz					
Input: $Z_{IN} = R_{IN} \parallel C_{IN}$		—	0,8 \parallel 17,6	—	k Ω \parallel pF
Output: $Z_{OUT} = R_{OUT} \parallel C_{OUT}$		—	0,7 \parallel 2,9	—	k Ω \parallel pF
Temperature coefficient of frequency	TC_f	—	- 72	—	ppm/K

Frequency response

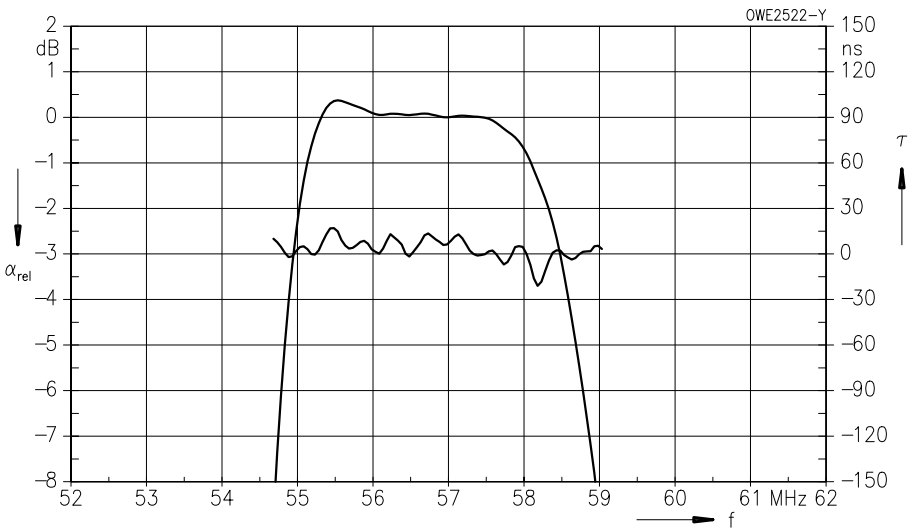
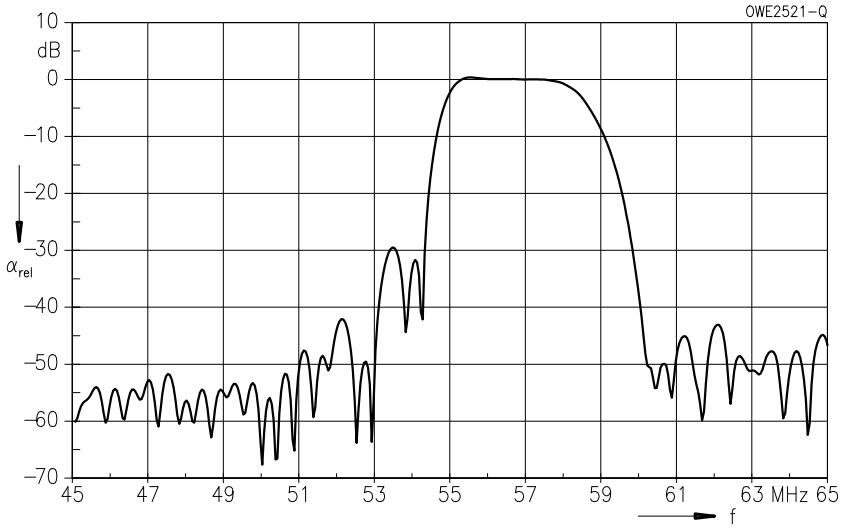

N 3561 M

58,75 MHz

Characteristics of sound channel

Ambient temperature $T_A = 25 (45) \text{ }^\circ\text{C}$
 Source impedance $Z_S = 50 \text{ } \Omega$
 Load impedance $Z_L = 2 \text{ k}\Omega \parallel 3 \text{ pF}$

		min.	typ.	max.	
Insertion attenuation α					
Reference level for the following data	54,33 (54,25) MHz	15,8	17,3	18,8	dB
Relative attenuation α_{rel}					
Picture carrier	58,83 (58,75) MHz	27,0	34,0	—	dB
Color carrier	55,25 (55,17) MHz	17,0	22,0	—	dB
Adjacent picture carrier	52,83 (52,83) MHz	30,0	37,0	—	dB
Adjacent sound carrier	60,33 (60,25) MHz	33,0	41,0	—	dB
Lower sidelobe					
	45,08 ... 52,83 (45,00 ... 52,75) MHz	27,0	33,0	—	dB
Upper sidelobe					
	60,33 ... 65,08 (60,25 ... 65,00) MHz	31,0	38,0	—	dB
Impedance at 54,33 MHz					
	Output: $Z_{OUT} = R_{OUT} \parallel C_{OUT}$	—	2,1 \parallel 5,0	—	k Ω \parallel pF
Temperature coefficient of frequency TC_f		—	-72	—	ppm/K

Frequency response

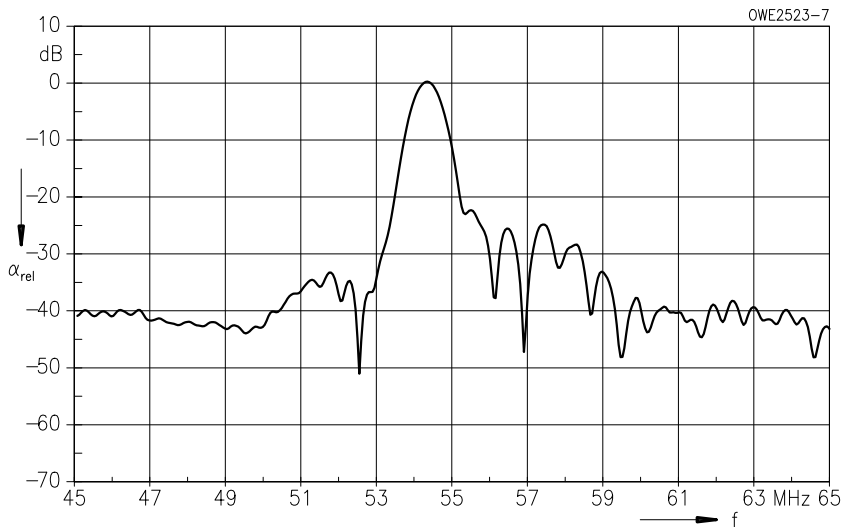

IF Filters for Video Applications

Survey

Picture carrier	Picture-to-sound carrier distance	Group delay ¹⁾	Sound carrier rejection ²⁾	Standard ³⁾	Package	Type	Page ⁴⁾
MHz	MHz		dB				
33,40	- 6,5	F	30	L	SIP 5 K ⁵⁾	G 3957 M	182
	- 6,5	F	41	L	DIP 10 K	K 6260 K ⁶⁾	#
33,90	- 6,5	F	59	L	SIP 5 K	K 3953 M	185
	- 6,5	F	54	L	DIP 10 K ⁵⁾	K 6256 K ⁶⁾	#
	- 6,5	F	54	L	DIP 10 K ⁵⁾	K 6257 K ⁶⁾	188
	- 6,5	C	58	L	DIP 10 K ⁵⁾	K 6263 K ⁶⁾	#
38,00	5,5 ... 6,5	F	40, 56	B/G, D/K	SIP 5 K	K 3955 M	193
	5,5 ... 6,5	C	48, 60	B/G, D/K	DIP 10 K ⁵⁾	K 6266 K ⁶⁾	196
	4,5	C	29	M/N	DIP 10 K ⁵⁾	K 6266 K ⁶⁾	196
38,90	5,5	C	39	B/G	SIP 5 K	G 3956 M	201
	5,5 ... 6,5	F	6, 45	B/G, L	SIP 5 K	G 3957 M	182
	5,5	C	54	B/G	SIP 5 K	G 3962 M	#
	5,5	F	56	B/G	SIP 5 K	G 3963 M	#
	5,5	C	51	B/G	SIP 5 K	G 3964 M	#
	5,5	F	51	B/G	SIP 5 K	G 3965 M	204
	5,5	C	61	B/G	SIP 5 K	G 3967 M	#
	5,5 ... 6,5	F	24, 54, 62	B/G, I, D/K, L	SIP 5 K	K 3953 M	185
	6,0 ... 6,5	F	53, 50	D/K, I, L	DIP 10 K ⁵⁾	K 6256 K ⁶⁾	#
	5,5	C	44	B/G	DIP 10 K ⁵⁾	K 6257 K ⁶⁾	188
	6,0 ... 6,5	F	52, 58	D/K, I, L	DIP 10 K ⁵⁾	K 6257 K ⁶⁾	188
	6,5	F	51	L	DIP 10 K ⁵⁾	K 6260 K ⁶⁾	#
	5,5	F	44	B/G	DIP 10 K ⁵⁾	K 6262 K ⁶⁾	#
	5,5 ... 6,5	C	42, 61	B/G, L	DIP 10 K ⁵⁾	K 6263 K ⁶⁾	#
	4,5	F	29	M/N	DIP 10 K ⁵⁾	K 6263 K ⁶⁾	#
4,5	F	45	M/N	SIP 5 K	M 3960 M	#	
39,50	6,0	F	50	I	SIP 5 K	J 3950 M	207
45,75	4,5	C	32	M/N	SIP 5 K	M 3951 M	210
58,75	4,5	F	40	M	SIP 5 K	N 3954 M	213
	4,5	F	40	M	SIP 5 K	N 3958 M	#

1) C: Customized
F: Flat

2) Typ., referred to filter roof

3) For explanation of standards see individual data sheets or index on page [349](#)

4) Filters marked by the sign # are only listed in the survey. Detailed information on these types upon request.

5) Pin configuration different from standard package

6) Internally switchable multistandard filter

Standard

- B/G-CCIR
Germany, Europe partly
- L/L'
France

Features

- TV IF filter with Nyquist slopes at 33,40 MHz and 38,90 MHz
- Constant group delay
- Suitable for CENELEC EN 55020

Terminals

- Tinned CuFe alloy

Plastic package **SIP 5 K**

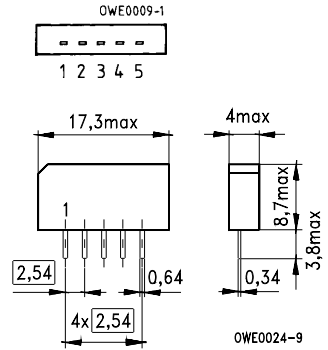

Dimensions in mm, approx. weight 1,0 g

Pin configuration

- 1 Input
- 2 Input – ground
- 3 Chip carrier – ground
- 4 Output
- 5 Output

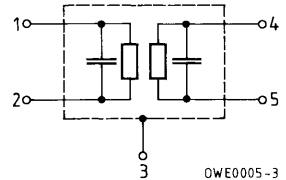

Type	Ordering code	Marking
G 3957 M	B39389-G3957-M100	Type, date code, pin 1

Maximum ratings

Ambient temperature	T_A	- 25/+ 65	°C	—
Storage temperature	T_{stg}	- 25/+ 85	°C	—
DC voltage	V_{DC}	12	V	between any terminals
AC voltage	V_{pp}	10	V	between any terminals

Characteristics

Ambient temperature $T_A = 25\text{ °C}$
 Source impedance $Z_S = 50\ \Omega$
 Load impedance $Z_L = 2\text{ k}\Omega \parallel 3\text{ pF}$

		min.	typ.	max.	
Insertion attenuation					
Reference level for the following data	37,40 MHz	α 14,4	15,9	17,4	dB
Relative attenuation					
Picture carrier B/G, L'	38,90 MHz	α_{rel} 4,8	5,8	6,8	dB
Picture carrier L'	33,40 MHz	5,0	6,0	7,0	dB
Adjacent picture carrier	30,90 MHz	48,0	60,0	—	dB
	31,90 MHz	48,0	62,0	—	dB
Adjacent sound carrier	40,40 MHz	46,0	56,0	—	dB
	41,40 MHz	41,0	46,0	—	dB
Lower sidelobe	25,00 ... 31,90 MHz	40,0	46,0	—	dB
Upper sidelobe	40,40 ... 45,00 MHz	38,0	43,0	—	dB
Reflected wave signal suppression					
1,1 μ s ... 6,0 μ s after main pulse (test pulse: 250 ns, carrier frequency: 37,40 MHz)		44,0	56,0	—	dB
Feedthrough signal suppression					
1,1 μ s ... 1,0 μ s before main pulse (test pulse: 250 ns, carrier frequency: 37,40 MHz)		50,0	56,0	—	dB
Group delay ripple (p-p)		$\Delta\tau$ —	40	—	ns
Impedance at 37,40 MHz					
Input: $Z_{IN} = R_{IN} \parallel C_{IN}$		—	1,6 \parallel 15,0	—	k Ω \parallel pF
Output: $Z_{OUT} = R_{OUT} \parallel C_{OUT}$		—	1,6 \parallel 4,3	—	k Ω \parallel pF
Temperature coefficient of frequency	TC_f	—	-72	—	ppm/K

G 3957 M
33,40/38,90 MHz

Frequency response

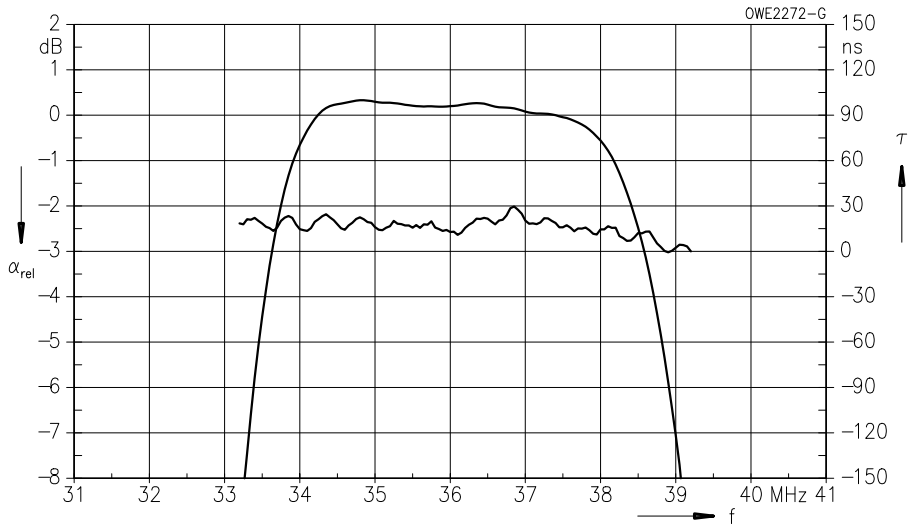
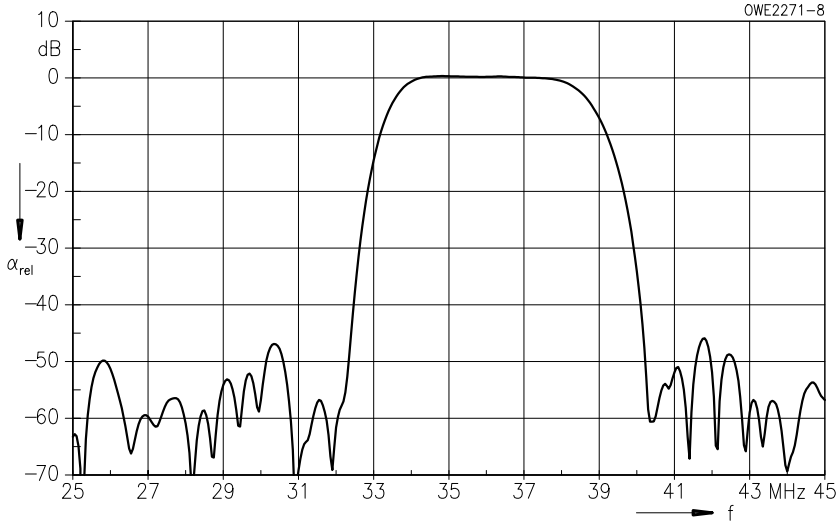

Standard

- B/G-CCIR
Germany, Europe partly
- D/K
Eastern standard
- I
Great Britain
- L/L'
France

Features

- TV IF filter with Nyquist slopes at 33,90 MHz and 38,90 MHz
- Constant group delay
- Suitable for CENELEC EN 55020

Terminals

- Tinned CuFe alloy

Pin configuration

- 1 Input
- 2 Input – ground
- 3 Chip carrier – ground
- 4 Output
- 5 Output

Plastic package **SIP 5 K**

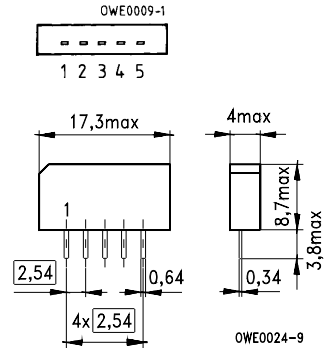

Dimensions in mm, approx. weight 1,0 g

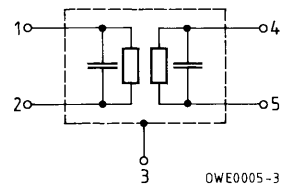

Type	Ordering code	Marking
K 3953 M	B39389-K3953-M100	Type, date code, pin 1

Maximum ratings

Ambient temperature	T_A	- 25/+ 65	°C	—
Storage temperature	T_{stg}	- 25/+ 85	°C	—
DC voltage	V_{DC}	12	V	between any terminals
AC voltage	V_{pp}	10	V	between any terminals

K 3953 M

33,90/38,90 MHz

Characteristics

Ambient temperature	$T_A = 25\text{ °C}$
Source impedance	$Z_S = 50\ \Omega$
Load impedance	$Z_L = 2\text{ k}\Omega \parallel 3\text{ pF}$

		min.	typ.	max.		
Insertion attenuation						
Reference level for the following data	37,40 MHz	α	12,0	13,5	15,0	dB
Relative attenuation						
Picture carrier	38,90 MHz	α_{rel}	4,7	5,7	6,7	dB
	33,90 MHz		6,3	7,5	8,7	dB
Sound carrier	33,40 MHz		20,0	24,0	—	dB
Adjacent picture carrier	UHF 30,90 MHz		48,0	62,0	—	dB
	VHF 31,90 MHz		48,0	59,0	—	dB
	40,15 MHz		36,0	40,0	—	dB
Adjacent sound carrier	VHF 40,40 MHz		47,0	59,0	—	dB
	UHF 41,40 MHz		46,0	60,0	—	dB
	40,90 MHz		46,0	59,0	—	dB
Lower sidelobe	25,00 ... 31,90 MHz		45,0	52,0	—	dB
Upper sidelobe	40,40 ... 45,00 MHz		38,0	44,0	—	dB
Reflected wave signal suppression						
1,2 μ s ... 6,0 μ s after main pulse (test pulse: 250 ns, carrier frequency: 37,40 MHz)			42,0	50,0	—	dB
Feedthrough signal suppression						
1,2 μ s ... 1,1 μ s before main pulse (test pulse: 250 ns, carrier frequency: 37,40 MHz)			50,0	56,0	—	dB
Group delay ripple (p-p)		$\Delta\tau$	—	50	—	ns
Impedance at 37,40 MHz						
Input: $Z_{IN} = R_{IN} \parallel C_{IN}$			—	1,5 \parallel 14,2	—	k Ω \parallel pF
Output: $Z_{OUT} = R_{OUT} \parallel C_{OUT}$			—	1,5 \parallel 5,4	—	k Ω \parallel pF
Temperature coefficient of frequency		TC_f	—	-72	—	ppm/K

Frequency response

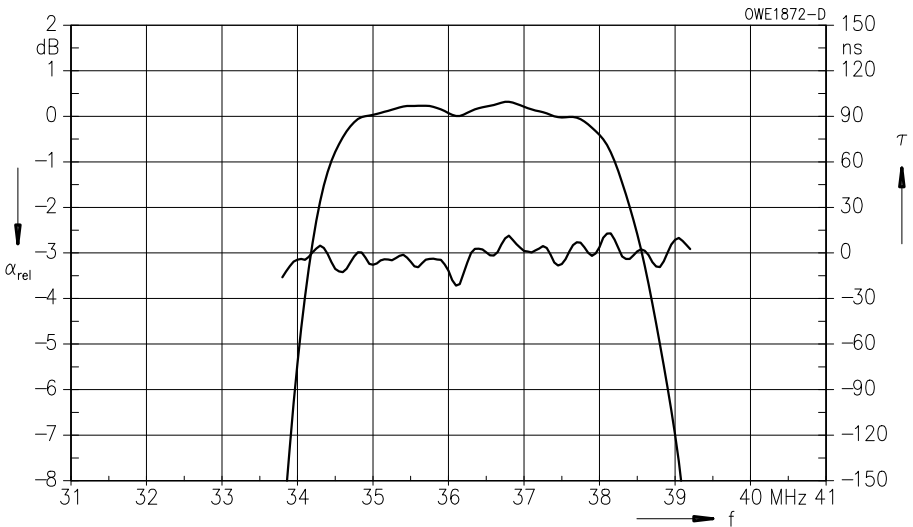
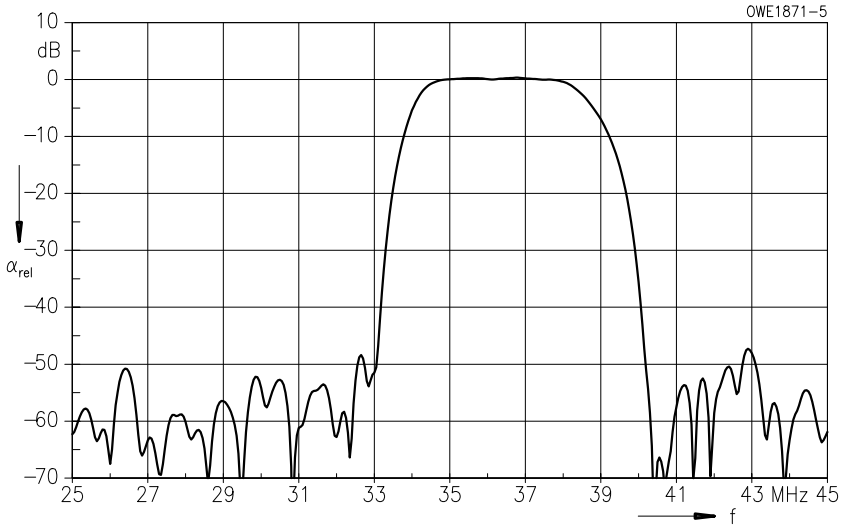

Standard

- B/G-CCIR
Germany, Europe partly
- D/K-OIRT
Eastern standard
- I
Great Britain
- L/L'
France

Plastic package DIP 10 K

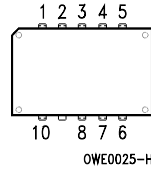

Features

- TV IF filter switchable from B/G mode to L/L' mode
- B/G mode with Nyquist slope and sound suppression
- Reduced group delay predistortion as compared with standard B/G half
- L/L' mode with Nyquist slopes at 38,90 MHz and 33,90 MHz
- Constant group delay
- Suitable for CENELEC EN 55020

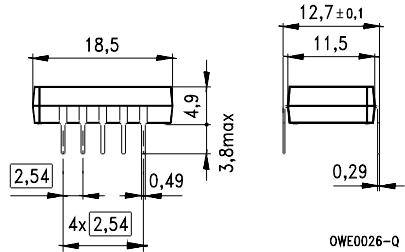

Dimensions in mm, approx. weight 1,8 g

Terminals

- Tinned CuFe alloy

Pin configuration

- 1 Input
- 2 Input – ground
- 3, 8 Chip carrier – ground
- 4, 5 Output
- 6, 7 Not connected
- 9 Free
- 10 Switching input

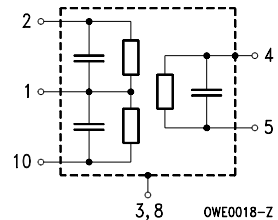

Type	Ordering code	Marking
K 6257 K	B39389-K6257-K100	Type, date code, pin 1

Maximum ratings

Ambient temperature	T_A	-25/+ 65	°C	—
Storage temperature	T_{stg}	-25/+ 85	°C	—
DC voltage	V_{DC}	12	V	between any terminals
AC voltage	V_{pp}	10	V	between any terminals

Characteristics in B/G mode (switching input pin 10 connected to ground input pin 2)

Ambient temperature $T_A = 25\text{ }^\circ\text{C}$
 Source impedance $Z_S = 50\ \Omega$
 Load impedance $Z_L = 2\ \text{k}\Omega \parallel 3\ \text{pF}$

		min.	typ.	max.		
Insertion attenuation						
Reference level for the following data	37,40 MHz	α	14,5	16,0	17,5	dB
Relative attenuation						
Picture carrier	38,90 MHz	α_{rel}	4,7	5,7	6,7	dB
Color carrier	34,47 MHz		0,3	1,3	2,3	dB
Sound carrier	33,40 MHz		35,0	44,0	—	dB
Adjacent picture carrier	UHF 30,90 MHz		44,0	60,0	—	dB
	VHF 31,90 MHz		46,0	60,0	—	dB
	32,40 MHz		46,0	60,0	—	dB
	40,15 MHz		38,0	45,0	—	dB
Adjacent sound carrier	VHF 40,40 MHz		43,0	54,0	—	dB
Adjacent picture carrier	UHF 41,40 MHz		40,0	48,0	—	dB
Lower sidelobe	25,00 ... 31,90 MHz		42,0	48,0	—	dB
Upper sidelobe	40,40 ... 45,00 MHz		38,0	45,0	—	dB
Reflected wave signal suppression						
1,2 μs ... 6,0 μs after main pulse (test pulse: 250 ns, carrier frequency: 37,40 MHz)			42,0	50,0	—	dB
Feedthrough signal suppression						
1,2 μs ... 1,1 μs before main pulse (test pulse: 250 ns, carrier frequency: 37,40 MHz)			—	56,0	—	dB
Group delay predistortion						
(reference frequency 38,90 MHz)		$\Delta\tau$				
	36,10 MHz		—	- 55	—	ns
	34,47 MHz		—	70	—	ns
Impedance at 37,40 MHz						
Input: $Z_{\text{IN}} = R_{\text{IN}} \parallel C_{\text{IN}}$			—	0,9 \parallel 23,6	—	$\text{k}\Omega \parallel \text{pF}$
Output: $Z_{\text{OUT}} = R_{\text{OUT}} \parallel C_{\text{OUT}}$			—	0,9 \parallel 6,5	—	$\text{k}\Omega \parallel \text{pF}$
Temperature coefficient of frequency						
		TC_f	—	- 72	—	ppm/K

Frequency response (B/G mode)

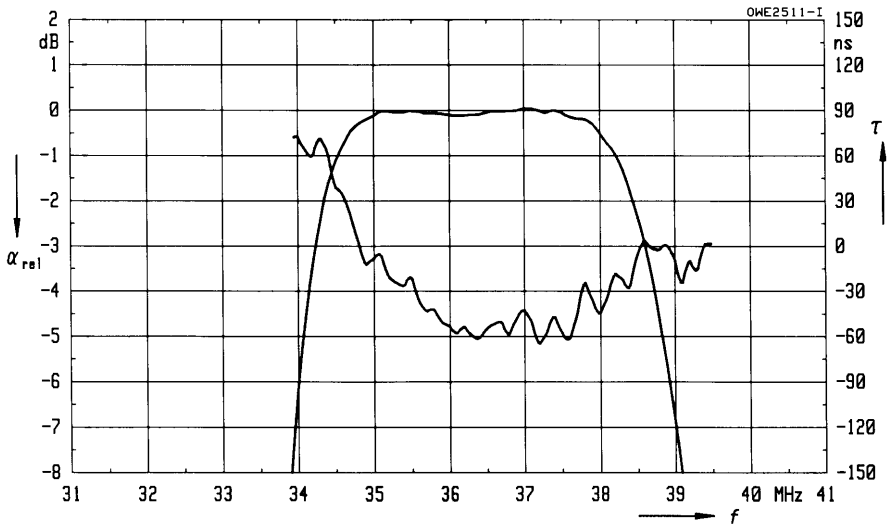
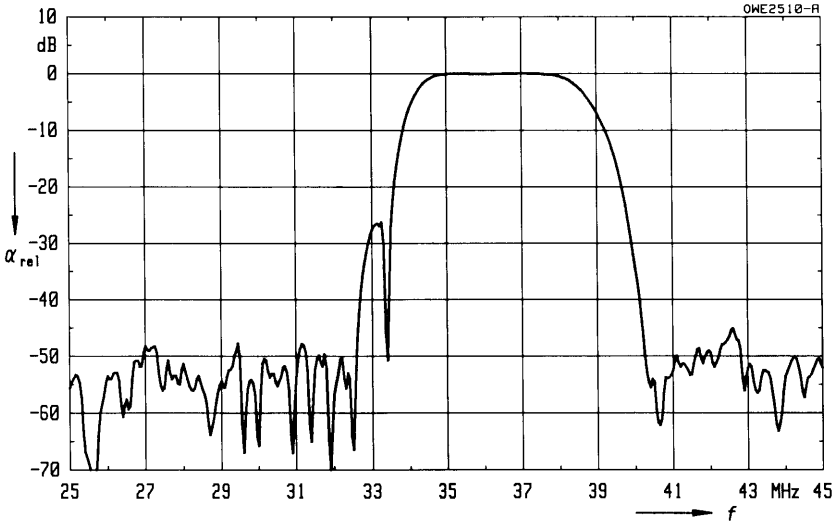

Characteristics in L/L' mode (switching input pin 10 connected to input pin 1)

Ambient temperature $T_A = 25\text{ °C}$
 Source impedance $Z_S = 50\ \Omega$
 Load impedance $Z_L = 2\text{ k}\Omega \parallel 3\text{ pF}$

		min.	typ.	max.		
Insertion attenuation						
Reference level for the following data	37,40 MHz	α	14,6	16,1	17,6	dB
Relative attenuation						
Picture carrier	38,90 MHz	α_{rel}	4,4	5,4	6,4	dB
	33,90 MHz		5,6	6,6	7,6	dB
	34,47 MHz		-0,2	0,8	1,8	dB
	30,90 MHz		46,0	58,0	—	dB
	32,40 MHz		46,0	58,0	—	dB
	32,90 MHz		42,0	52,0	—	dB
	40,40 MHz		43,0	54,0	—	dB
	40,90 MHz		42,0	52,0	—	dB
	41,90 MHz		41,0	48,0	—	dB
Lower sidelobe	25,00 ... 32,90 MHz		41,0	46,0	—	dB
Upper sidelobe	40,40 ... 45,00 MHz		39,0	45,0	—	dB
Reflected wave signal suppression						
1,2 μ s ... 6,0 μ s after main pulse (test pulse: 250 ns, carrier frequency: 37,40 MHz)			42,0	52,0	—	dB
Feedthrough signal suppression						
1,2 μ s ... 1,1 μ s before main pulse (test pulse: 250 ns, carrier frequency: 37,40 MHz)			—	56,0	—	dB
Group delay ripple (p-p)		$\Delta\tau$	—	50	—	ns
Impedance at 37,40 MHz						
Input: $Z_{IN} = R_{IN} \parallel C_{IN}$			—	1,5 \parallel 16,9	—	k Ω \parallel pF
Output: $Z_{OUT} = R_{OUT} \parallel C_{OUT}$			—	0,9 \parallel 6,5	—	k Ω \parallel pF
Temperature coefficient of frequency		TC_f	—	-72	—	ppm/K

K 6257 K
33,90/38,90 MHz

Frequency response (L/L' mode)

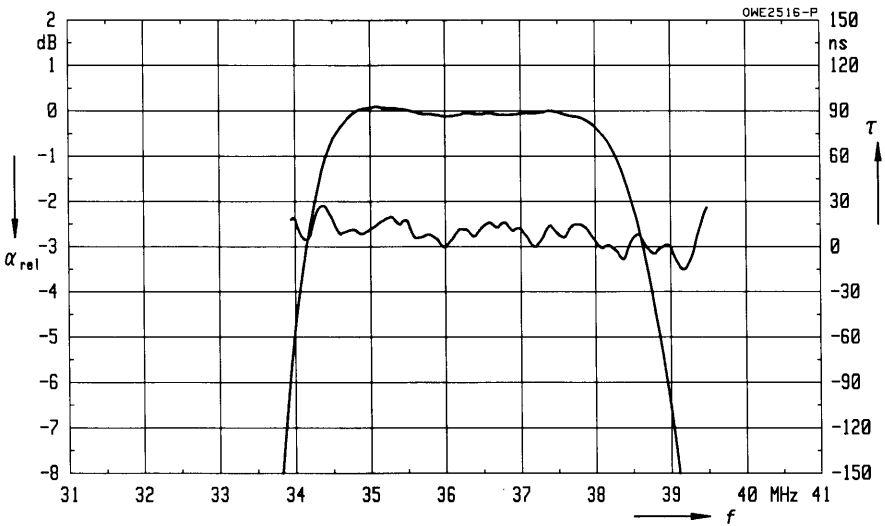
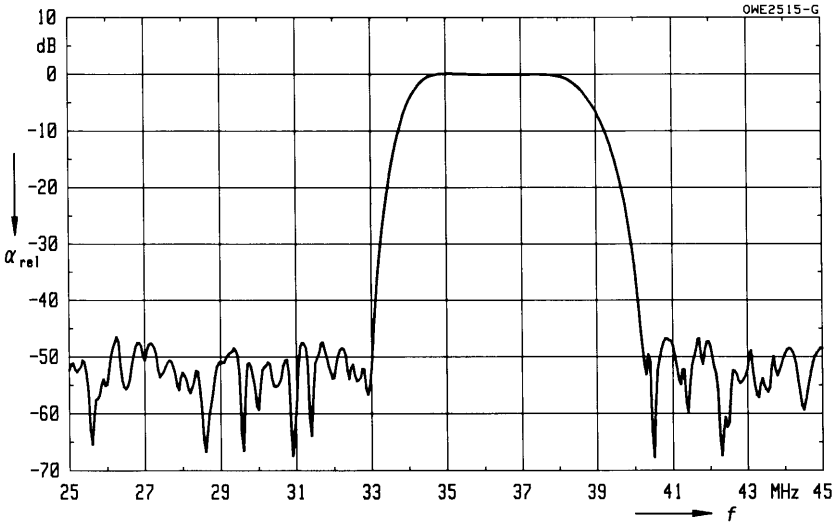

Standard

- D/K-OIRT
Eastern standard
- B/G-CCIR
Europe partly

Features

- TV IF filter with Nyquist slope and sound suppression
- High color carrier level
- Constant group delay
- Suitable for CENELEC EN 55020

Terminals

- Tinned CuFe alloy

Plastic package **SIP 5 K**

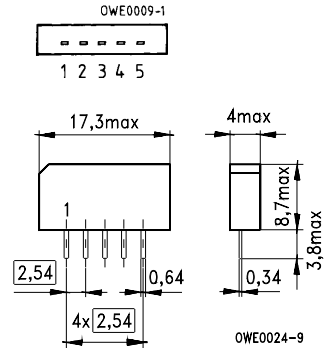

Dimensions in mm, approx. weight 1,0 g

Pin configuration

- 1 Input
- 2 Input – ground
- 3 Chip carrier – ground
- 4 Output
- 5 Output

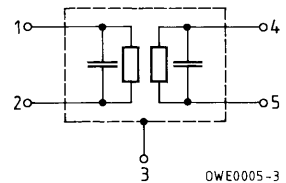

Type	Ordering code	Marking
K 3955 M	B39380-K3955-M100	Type, date code, pin 1

Maximum ratings

Ambient temperature	T_A	- 25/+ 65	°C	—
Storage temperature	T_{stg}	- 25/+ 85	°C	—
DC voltage	V_{DC}	12	V	between any terminals
AC voltage	V_{pp}	10	V	between any terminals

K 3955 M

38,00 MHz

Characteristics

Ambient temperature	$T_A = 25\text{ °C}$
Source impedance	$Z_S = 50\ \Omega$
Load impedance	$Z_L = 2\text{ k}\Omega \parallel 3\text{ pF}$

		min.	typ.	max.	
Insertion attenuation					
Reference level for the following data	36,50 MHz	α 13,3	14,8	16,3	dB
Relative attenuation					
Picture carrier	38,00 MHz	α_{rel} 4,7	5,7	6,7	dB
Color carrier	33,57 MHz	-0,2	0,8	1,8	dB
Sound carrier	31,50 MHz	46,0	56,0	—	dB
	32,50 MHz	30,0	40,0	—	dB
Adjacent picture carrier	30,00 MHz	48,0	60,0	—	dB
	31,00 MHz	50,0	62,0	—	dB
Adjacent sound carrier	39,50 MHz	46,0	56,0	—	dB
	40,50 MHz	44,0	58,0	—	dB
Lower sidelobe	25,00 ... 30,00 MHz	41,0	48,0	—	dB
Upper sidelobe	39,50 ... 45,00 MHz	38,0	43,0	—	dB
Reflected wave signal suppression					
1,2 μ s ... 6,0 μ s after main pulse (test pulse: 250 ns, carrier frequency: 36,50 MHz)		42,0	55,0	—	dB
Feedthrough signal suppression					
1,2 μ s ... 1,1 μ s before main pulse (test pulse: 250 ns, carrier frequency: 36,50 MHz)		50,0	56,0	—	dB
Group delay ripple (p-p)		$\Delta\tau$	40	—	ns
Impedance at 36,50 MHz					
Input: $Z_{IN} = R_{IN} \parallel C_{IN}$		—	1,5 \parallel 15,5	—	k Ω \parallel pF
Output: $Z_{OUT} = R_{OUT} \parallel C_{OUT}$		—	1,9 \parallel 3,9	—	k Ω \parallel pF
Temperature coefficient of frequency		TC_f	-72	—	ppm/K

Frequency response

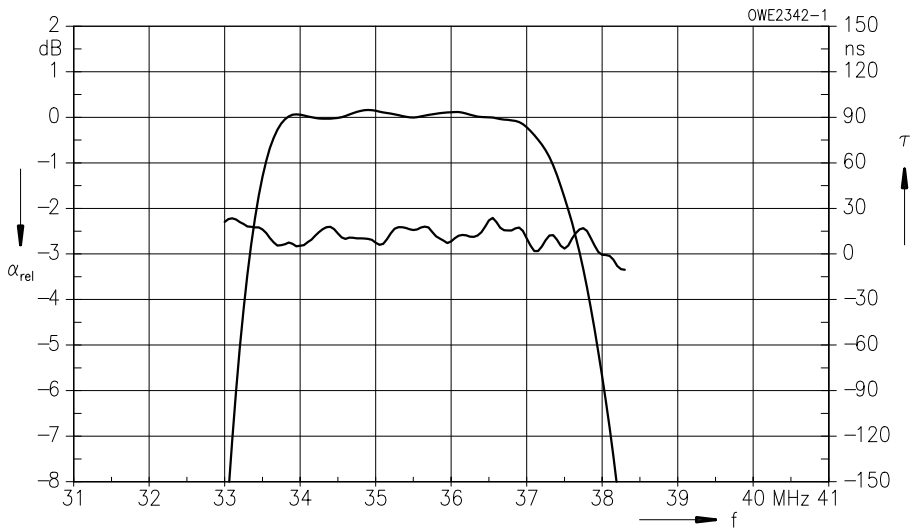
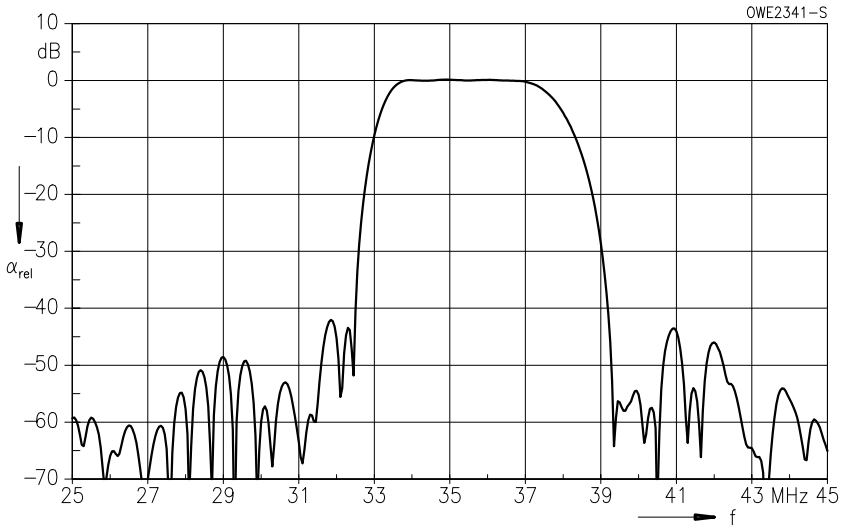

Standard

- B/G-CCIR
Germany, Europe partly
- D/K-OIRT
Eastern standard
- M/N-FCC
USA

Plastic package DIP 10 K

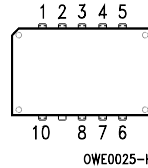

Features

- TV IF filter switchable from M/N mode to B/G mode
- M/N mode with Nyquist slope and sound suppression
- Customized group delay predistortion
- B/G mode with Nyquist slope and sound suppression
- Reduced group delay predistortion as compared with standard B/G, half
- Suitable for CENELEC EN 55020

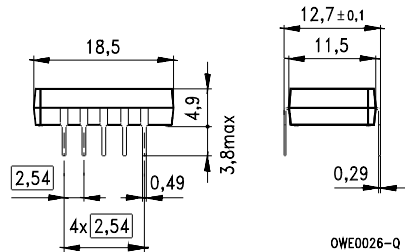

Dimensions in mm, approx. weight 1,8 g

Terminals

- Tinned CuFe alloy

Pin configuration

- 1 Input
- 2 Input – ground
- 3, 8 Chip carrier – ground
- 4, 5 Output
- 6, 7 Not connected
- 9 Free
- 10 Switching input

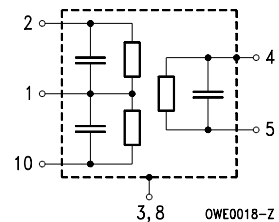

Type	Ordering code	Marking
K 6266 K	B39380-K6266-K100	Type, date code, pin 1

Maximum ratings

Ambient temperature	T_A	- 25/+ 65	°C	—
Storage temperature	T_{stg}	- 25/+ 85	°C	—
DC voltage	V_{DC}	12	V	between any terminals
AC voltage	V_{pp}	10	V	between any terminals

Characteristics in M/N mode (switching input pin 10 connected to input pin 1)

Ambient temperature $T_A = 25\text{ °C}$
 Source impedance $Z_S = 50\ \Omega$
 Load impedance $Z_L = 2\text{ k}\Omega \parallel 3\text{ pF}$

		min.	typ.	max.	
Insertion attenuation					
Reference level for the following data	36,50 MHz	α 14,4	15,9	17,4	dB
Relative attenuation					
Picture carrier	38,00 MHz	α_{rel} 4,5	5,5	6,5	dB
Color carrier	34,42 MHz	1,3	2,3	3,3	dB
Sound carrier	33,50 MHz	24,0	29,0	—	dB
Adjacent picture carrier	32,00 MHz	46,0	58,0	—	dB
Adjacent sound carrier	39,50 MHz	46,0	58,0	—	dB
Lower sidelobe	25,00 ... 32,00 MHz	36,0	42,0	—	dB
Upper sidelobe	39,50 ... 45,00 MHz	38,0	43,0	—	dB
Reflected wave signal suppression					
1,2 μ s ... 6,0 μ s after main pulse (test pulse: 250 ns, carrier frequency: 36,50 MHz)		42,0	51,0	—	dB
Feedthrough signal suppression					
1,2 μ s ... 1,1 μ s before main pulse (test pulse: 250 ns, carrier frequency: 36,50 MHz)		—	56,0	—	dB
Group delay predistortion					
(reference frequency 38,00 MHz)		$\Delta\tau$			
	35,00 MHz	—	20	—	ns
	34,42 MHz	—	70	—	ns
Impedance at 36,50 MHz					
Input: $Z_{IN} = R_{IN} \parallel C_{IN}$		—	1,1 \parallel 21,2	—	k Ω \parallel pF
Output: $Z_{OUT} = R_{OUT} \parallel C_{OUT}$		—	1,4 \parallel 6,5	—	k Ω \parallel pF
Temperature coefficient of frequency		TC_f	—	-72	ppm/K

Frequency response (M/N mode)

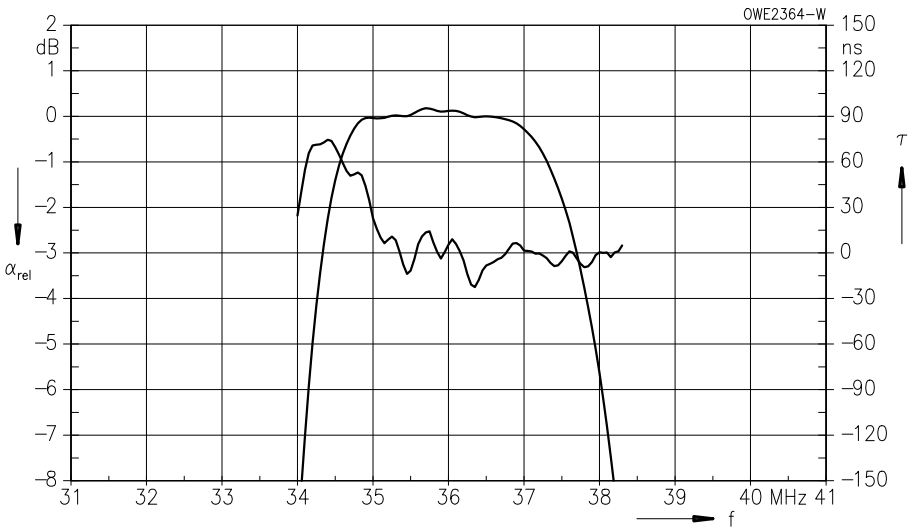
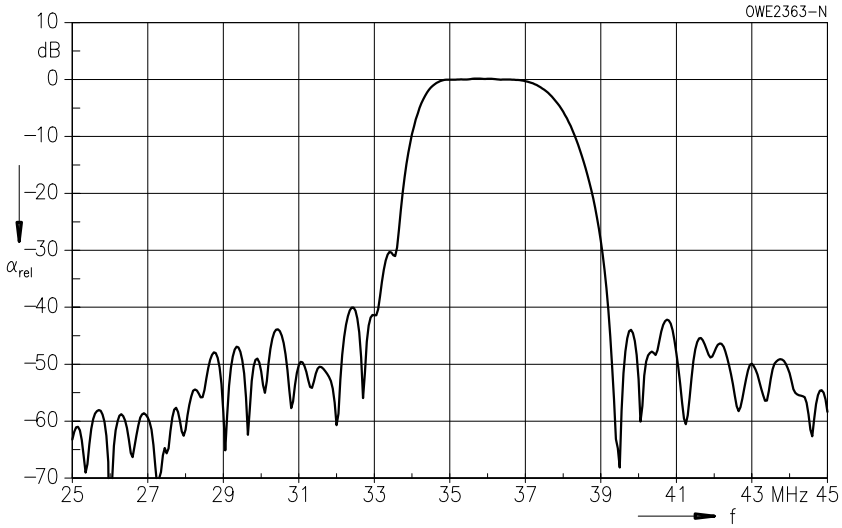

Characteristics in B/G mode (switching input pin 10 connected to ground input pin 2)

Ambient temperature $T_A = 25\text{ °C}$
 Source impedance $Z_S = 50\ \Omega$
 Load impedance $Z_L = 2\text{ k}\Omega \parallel 3\text{ pF}$

		min.	typ.	max.	
Insertion attenuation					
	α				
Reference level for the following data	36,50 MHz	14,4	15,9	17,4	dB
Relative attenuation					
	α_{rel}				
Picture carrier	38,00 MHz	4,6	5,6	6,6	dB
Color carrier	33,57 MHz	1,2	2,2	3,2	dB
Sound carrier	32,50 MHz	38,0	48,0	—	dB
	32,00 MHz	27,0	32,0	—	dB
	31,50 MHz	48,0	60,0	—	dB
Adjacent picture carrier	30,00 MHz	46,0	56,0	—	dB
	31,00 MHz	46,0	56,0	—	dB
Adjacent sound carrier	39,50 MHz	44,0	54,0	—	dB
	40,00 MHz	42,0	51,0	—	dB
	40,50 MHz	—	46,0	—	dB
Lower sidelobe	25,00 ... 30,00 MHz	42,0	49,0	—	dB
Upper sidelobe	39,50 ... 45,00 MHz	36,0	41,0	—	dB
Reflected wave signal suppression					
1,2 μ s ... 6,0 μ s after main pulse (test pulse: 250 ns, carrier frequency: 36,50 MHz)		42,0	50,0	—	dB
Feedthrough signal suppression					
1,2 μ s ... 1,1 μ s before main pulse (test pulse: 250 ns, carrier frequency: 36,50 MHz)		—	56,0	—	dB
Group delay predistortion					
	$\Delta\tau$				
(reference frequency 38,00 MHz)					
	36,00 MHz	—	- 50	—	ns
	33,57 MHz	—	70	—	ns
Impedance at 36,50 MHz					
Input: $Z_{IN} = R_{IN} \parallel C_{IN}$		—	0,9 \parallel 25,6	—	k Ω \parallel pF
Output: $Z_{OUT} = R_{OUT} \parallel C_{OUT}$		—	1,0 \parallel 6,5	—	k Ω \parallel pF
Temperature coefficient of frequency					
	TC_f	—	- 72	—	ppm/K

Frequency response (B/G mode)

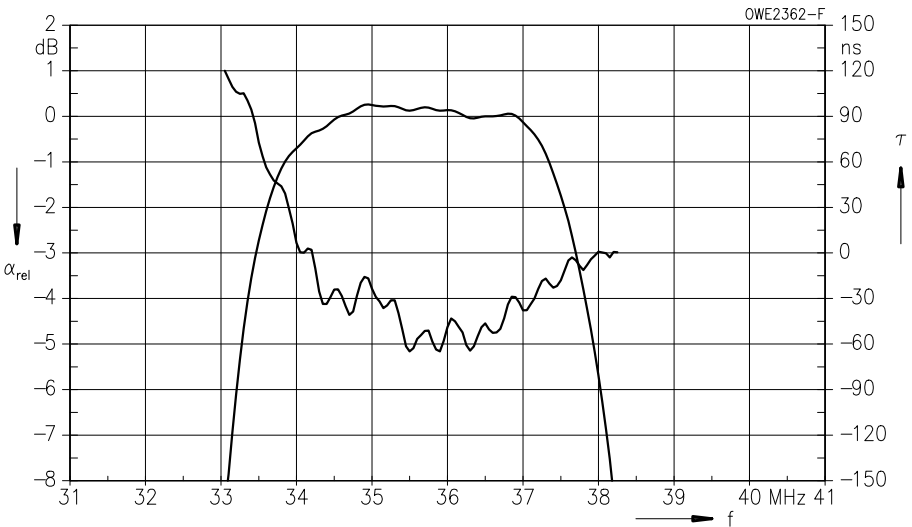
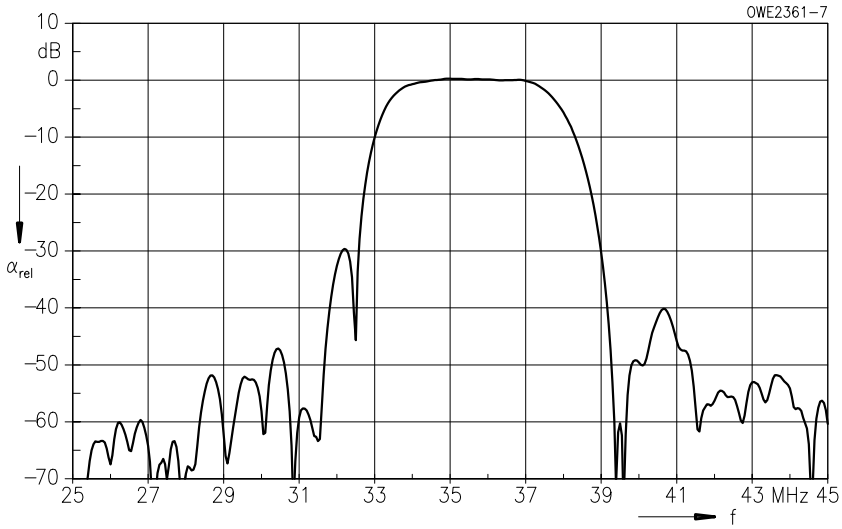

Standard

- B/G-CCIR
Germany, Europe partly

Features

- TV IF filter with Nyquist slope and sound suppression
- High color carrier level
- Reduced group delay predistortion as compared with standard B/G, half
- Suitable for CENELEC EN 55020

Terminals

- Tinned CuFe alloy

Plastic package **SIP 5 K**

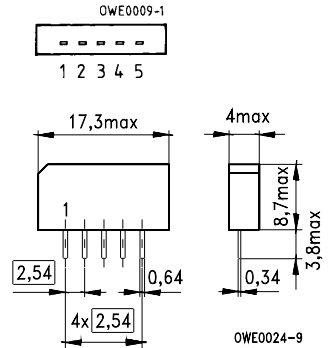

Dimensions in mm, approx. weight 1,0 g

Pin configuration

- 1 Input
- 2 Input – ground
- 3 Chip carrier – ground
- 4 Output
- 5 Output

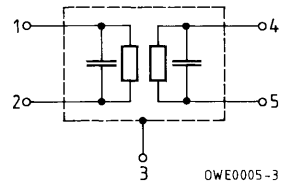

Type	Ordering code	Marking
G 3956 M	B39389-G3956-M100	Type, date code, pin 1

Maximum ratings

Ambient temperature	T_A	- 25/+ 65	°C	–
Storage temperature	T_{stg}	- 25/+ 85	°C	–
DC voltage	V_{DC}	12	V	between any terminals
AC voltage	V_{pp}	10	V	between any terminals

G 3956 M

38,90 MHz

Characteristics

Ambient temperature	$T_A = 25\text{ °C}$
Source impedance	$Z_S = 50\ \Omega$
Load impedance	$Z_L = 2\text{ k}\Omega \parallel 3\text{ pF}$

		min.	typ.	max.		
Insertion attenuation						
Reference level for the following data	37,40 MHz	α	12,4	13,9	15,4	dB
Relative attenuation						
Picture carrier	38,90 MHz	α_{rel}	5,1	6,1	7,1	dB
Color carrier	34,47 MHz		0,0	1,0	2,0	dB
Sound carrier	33,40 MHz		26,0	39,0	—	dB
	33,15 MHz		—	25,0	—	dB
	33,90 MHz		—	7,0	—	dB
Adjacent picture carrier	UHF 30,90 MHz		48,0	58,0	—	dB
	VHF 31,90 MHz		48,0	56,0	—	dB
	31,40 MHz		44,0	52,0	—	dB
	32,40 MHz		48,0	60,0	—	dB
Adjacent stereo sound carrier	40,15 MHz		42,0	51,0	—	dB
Adjacent sound carrier	VHF 40,40 MHz		44,0	51,0	—	dB
	UHF 41,40 MHz		41,0	46,0	—	dB
Lower sidelobe	25,00 ... 31,90 MHz		42,0	49,0	—	dB
Upper sidelobe	40,40 ... 45,00 MHz		40,0	46,0	—	dB
Reflected wave signal suppression						
1,3 μ s ... 6,0 μ s after main pulse (test pulse: 250 ns, carrier frequency: 37,40 MHz)			42,0	52,0	—	dB
Feedthrough signal suppression						
1,2 μ s ... 1,1 μ s before main pulse (test pulse: 250 ns, carrier frequency: 37,40 MHz)			50,0	56,0	—	dB
Group delay predistortion						
(reference frequency 38,90 MHz)		$\Delta\tau$				
	36,90 MHz		—	- 85	—	ns
	34,47 MHz		—	70	—	ns
Impedance at 37,40 MHz						
Input:	$Z_{IN} = R_{IN} \parallel C_{IN}$		—	1,3 \parallel 16,6	—	k Ω \parallel pF
Output:	$Z_{OUT} = R_{OUT} \parallel C_{OUT}$		—	1,4 \parallel 4,5	—	k Ω \parallel pF
Temperature coefficient of frequency						
		TC_f	—	- 72	—	ppm/K

Frequency response

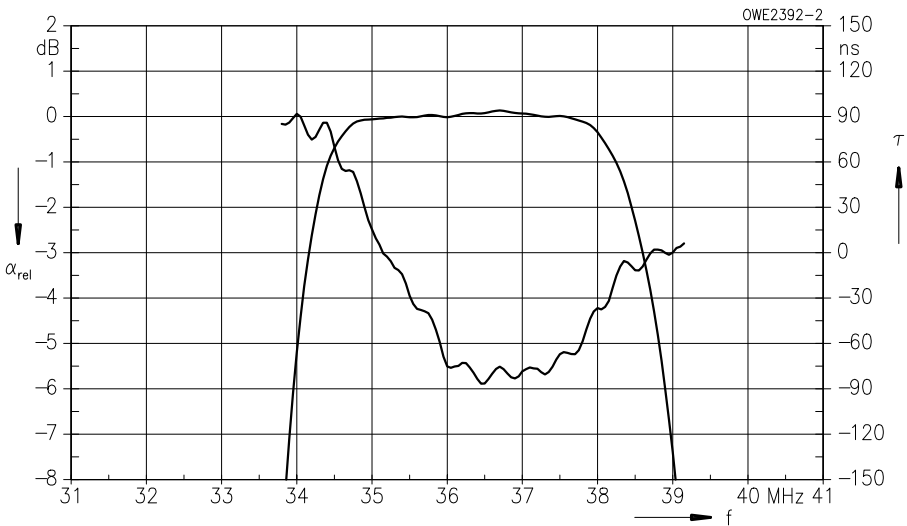
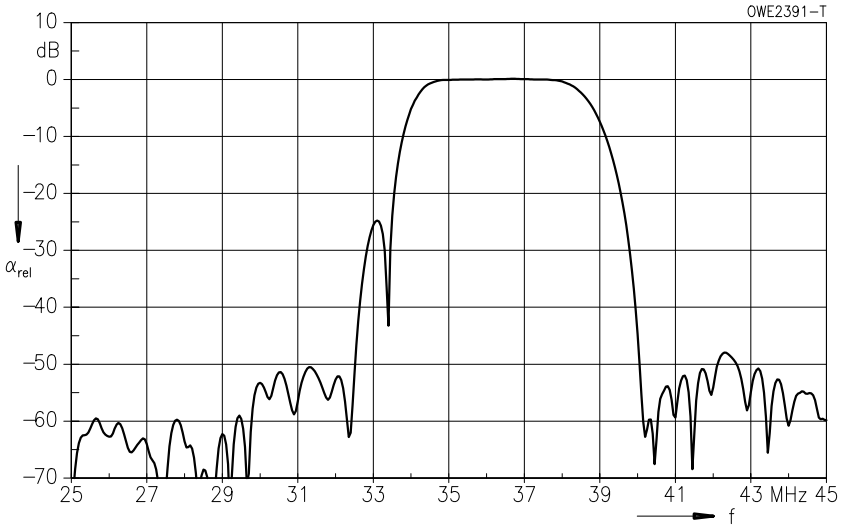

Standard

- B/G-CCIR
Germany, Europe partly

Features

- TV IF filter with Nyquist slope and sound suppression
- Constant group delay
- Suitable for CENELEC EN 55020

Terminals

- Tinned CuFe alloy

Plastic package **SIP 5 K**

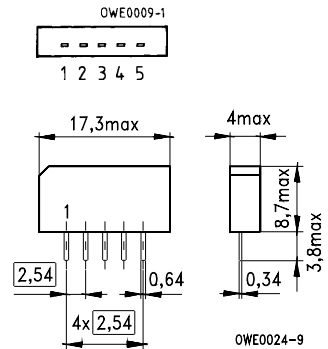

Dimensions in mm, approx. weight 1,0 g

Pin configuration

- 1 Input
- 2 Input – ground
- 3 Chip carrier – ground
- 4 Output
- 5 Output

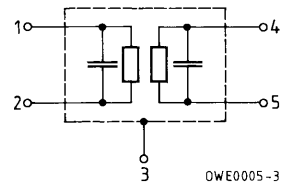

Type	Ordering code	Marking
G 3965 M	B39389-G3965-M100	Type, date code, pin 1

Maximum ratings

Ambient temperature	T_A	- 25/+ 65	°C	—
Storage temperature	T_{stg}	- 25/+ 85	°C	—
DC voltage	V_{DC}	12	V	between any terminals
AC voltage	V_{pp}	10	V	between any terminals

Characteristics

Ambient temperature $T_A = 25\text{ °C}$
 Source impedance $Z_S = 50\ \Omega$
 Load impedance $Z_L = 2\text{ k}\Omega \parallel 3\text{ pF}$

		min.	typ.	max.		
Insertion attenuation						
Reference level for the following data	37,40 MHz	α	13,1	14,6	16,1	dB
Relative attenuation						
Picture carrier	38,90 MHz	α_{rel}	4,6	5,3	6,0	dB
Color carrier	34,47 MHz		1,9	2,9	3,9	dB
Sound carrier	33,40 MHz		40,0	51,0	—	dB
Adjacent picture carrier	UHF 30,90 MHz		46,0	54,0	—	dB
	VHF 31,90 MHz		48,0	58,0	—	dB
Adjacent sound carrier	VHF 31,40 MHz		42,0	48,0	—	dB
	UHF 32,40 MHz		46,0	56,0	—	dB
	UHF 40,15 MHz		36,0	54,0	—	dB
Lower sidelobe	VHF 40,40 MHz		45,0	52,0	—	dB
	UHF 41,40 MHz		44,0	56,0	—	dB
Upper sidelobe	25,00 ... 32,40 MHz		41,0	47,0	—	dB
	40,40 ... 45,00 MHz		36,0	42,0	—	dB
Reflected wave signal suppression						
1,2 μ s ... 6,0 μ s after main pulse (test pulse: 250 ns, carrier frequency: 37,40 MHz)			42,0	52,0	—	dB
Feedthrough signal suppression						
1,3 μ s ... 1,2 μ s before main pulse (test pulse: 250 ns, carrier frequency: 37,40 MHz)			50,0	56,0	—	dB
Group delay ripple (p-p)		$\Delta\tau$	—	50	—	ns
Impedance at 37,40 MHz						
Input: $Z_{IN} = R_{IN} \parallel C_{IN}$			—	1,6 \parallel 15,0	—	k Ω \parallel pF
Output: $Z_{OUT} = R_{OUT} \parallel C_{OUT}$			—	1,3 \parallel 4,8	—	k Ω \parallel pF
Temperature coefficient of frequency		TC_f	—	-72	—	ppm/K

Frequency response

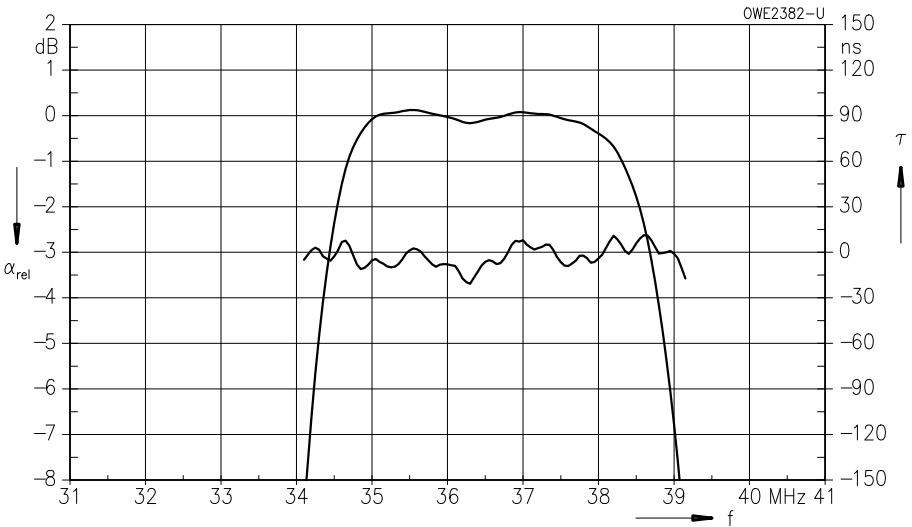
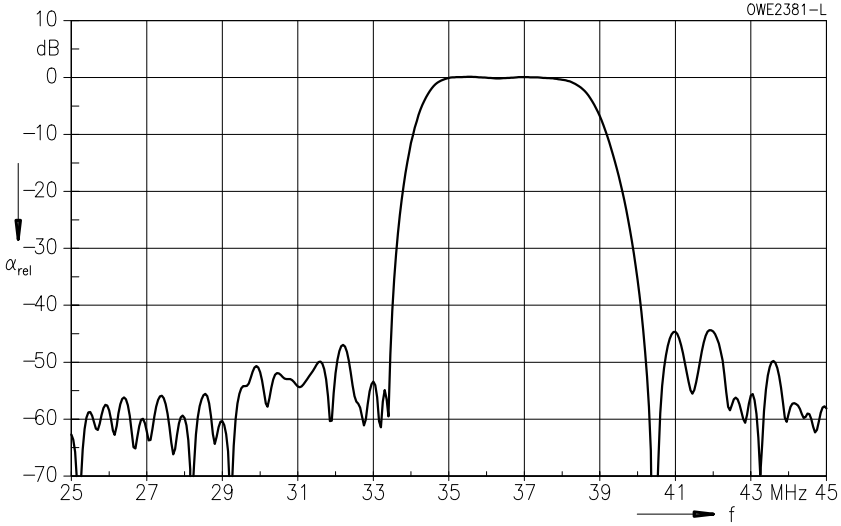

Standard

- I
Great Britain

Features

- TV IF filter for video applications with Nyquist slope and sound suppression
- Constant group delay
- Suitable for CENELEC EN 55020

Terminals

- Tinned CuFe alloy

Plastic package **SIP 5 K**

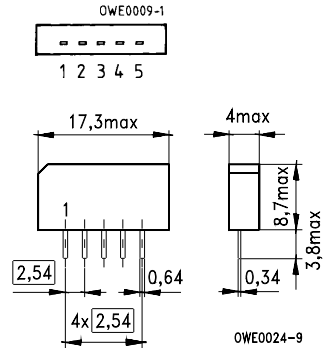

Dimensions in mm, approx. weight 1,0 g

Pin configuration

- 1 Input
- 2 Input – ground
- 3 Chip carrier – ground
- 4 Output
- 5 Output

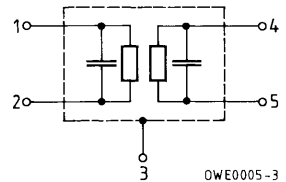

Type	Ordering code	Marking
J 3950 M	B39395-J3950-M100	Type, date code, pin 1

Maximum ratings

Ambient temperature	T_A	- 25/+ 65	°C	—
Storage temperature	T_{stg}	- 25/+ 85	°C	—
DC voltage	V_{DC}	12	V	between any terminals
AC voltage	V_{pp}	10	V	between any terminals

J 3950 M

39,50 MHz

Characteristics

Ambient temperature	$T_A = 25\text{ °C}$
Source impedance	$Z_S = 50\ \Omega$
Load impedance	$Z_L = 2\text{ k}\Omega \parallel 3\text{ pF}$

		min.	typ.	max.	
Insertion attenuation					
Reference level for the following data	38,00 MHz	α 14,2	15,7	17,2	dB
Relative attenuation					
Picture carrier	39,50 MHz	α_{rel} 4,5	5,5	6,5	dB
Color carrier	35,07 MHz	1,2	2,2	3,2	dB
Sound carrier	33,50 MHz	43,0	50,0	—	dB
	32,95 MHz	44,0	58,0	—	dB
Adjacent picture carrier	31,50 MHz	48,0	62,0	—	dB
	31,00 MHz	46,0	60,0	—	dB
	32,00 MHz	46,0	60,0	—	dB
Adjacent sound carrier	41,50 MHz	44,0	57,0	—	dB
	40,95 MHz	42,0	54,0	—	dB
Lower sidelobe	25,00 ... 31,50 MHz	42,0	52,0	—	dB
Upper sidelobe	41,50 ... 45,00 MHz	37,0	44,0	—	dB
Reflected wave signal suppression					
1,0 μ s ... 6,0 μ s after main pulse (test pulse: 250 ns, carrier frequency: 38,00 MHz)		42,0	57,0	—	dB
Feedthrough signal suppression					
1,1 μ s ... 1,0 μ s before main pulse (test pulse: 250 ns, carrier frequency: 38,00 MHz)		50,0	56,0	—	dB
Group delay ripple (p-p)		$\Delta\tau$	30	—	ns
Impedance at 38,00 MHz					
Input: $Z_{IN} = R_{IN} \parallel C_{IN}$		—	1,8 \parallel 12,8	—	k Ω \parallel pF
Output: $Z_{OUT} = R_{OUT} \parallel C_{OUT}$		—	2,7 \parallel 3,3	—	k Ω \parallel pF
Temperature coefficient of frequency		TC_f	—	-72	ppm/K

Frequency response

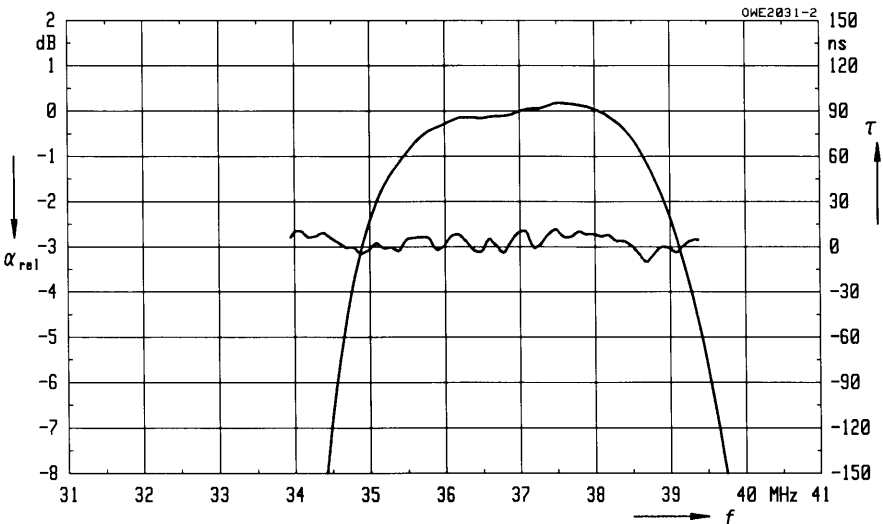
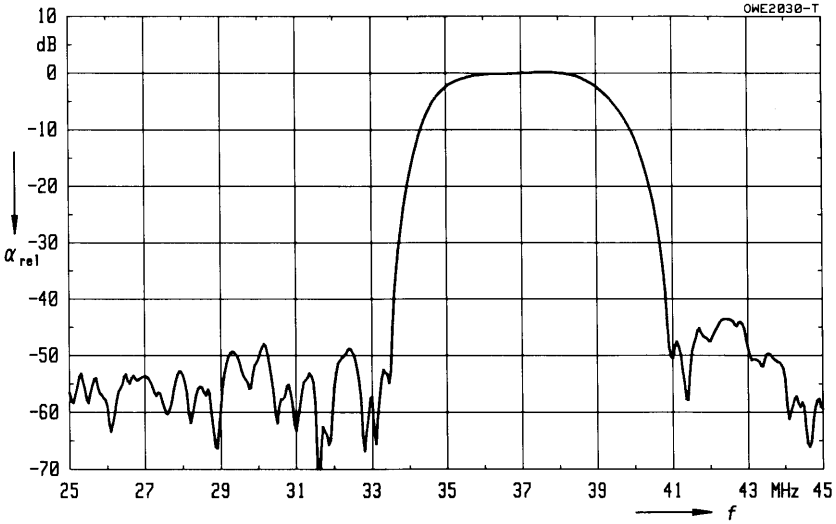

Standard

- M/N-FCC
USA

Features

- TV IF filter with Nyquist slope and sound suppression
- Customized group delay predistortion
- Suitable for FCC EIA/IS-31 regulations

Terminals

- Tinned CuFe alloy

Plastic package **SIP 5 K**

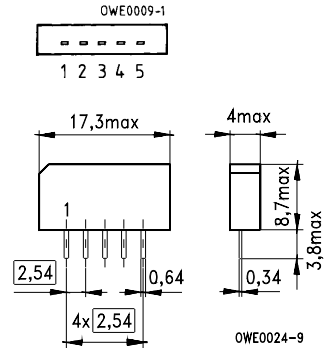

Dimensions in mm, approx. weight 1,0 g

Pin configuration

- 1 Input
- 2 Input – ground
- 3 Chip carrier – ground
- 4 Output
- 5 Output

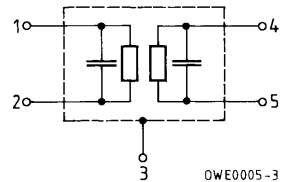

Type	Ordering code	Marking
M 3951 M	B39458-M3951-M100	Type, date code, pin 1

Maximum ratings

Ambient temperature	T_A	- 25/+ 65	°C	—
Storage temperature	T_{stg}	- 25/+ 85	°C	—
DC voltage	V_{DC}	12	V	between any terminals
AC voltage	V_{pp}	10	V	between any terminals

Characteristics

Ambient temperature $T_A = 25 (45) \text{ }^\circ\text{C}$
 Source impedance $Z_S = 50 \text{ } \Omega$
 Load impedance $Z_L = 2 \text{ k}\Omega \parallel 3 \text{ pF}$

		min.	typ.	max.		
Insertion attenuation						
Reference level for the following data	44,06 (44,00) MHz	α	11,0	12,5	14,0	dB
Relative attenuation						
Picture carrier	45,81 (45,75) MHz	α_{rel}	4,6	5,6	6,6	dB
Color carrier	42,23 (42,17) MHz		1,2	2,2	3,2	dB
Sound carrier	41,31 (41,25) MHz		25,0	32,0	—	dB
Adjacent picture carrier	39,81 (39,75) MHz		48,0	61,0	—	dB
Adjacent sound carrier	47,31 (47,25) MHz		46,0	56,0	—	dB
Lower sidelobe						
	35,06 ... 39,81 (35,00 ... 39,75) MHz		38,0	42,0	—	dB
Upper sidelobe						
	47,31 ... 55,06 (47,25 ... 55,00) MHz		36,0	41,0	—	dB
Reflected wave signal suppression						
1,1 μs ... 6,0 μs after main pulse (test pulse: 250 ns, carrier frequency: 44,06 MHz)			42,0	52,0	—	dB
Feedthrough signal suppression						
1,2 μs ... 1,1 μs before main pulse (test pulse: 250 ns, carrier frequency: 44,06 MHz)			50,0	56,0	—	dB
Group delay predistortion						
(reference frequency: 45,81 MHz)		$\Delta\tau$				
	42,81 (42,75) MHz		—	- 10	—	ns
	42,23 (42,17) MHz		—	- 40	—	ns
Group delay ripple (p-p)						
		$\Delta\tau$	—	40	—	ns
Impedance at 44,06 MHz						
Input: $Z_{IN} = R_{IN} \parallel C_{IN}$			—	1,4 \parallel 10,8	—	k Ω \parallel pF
Output: $Z_{OUT} = R_{OUT} \parallel C_{OUT}$			—	0,9 \parallel 4,4	—	k Ω \parallel pF
Temperature coefficient of frequency						
		TC_f	—	- 72	—	ppm/K

Frequency response

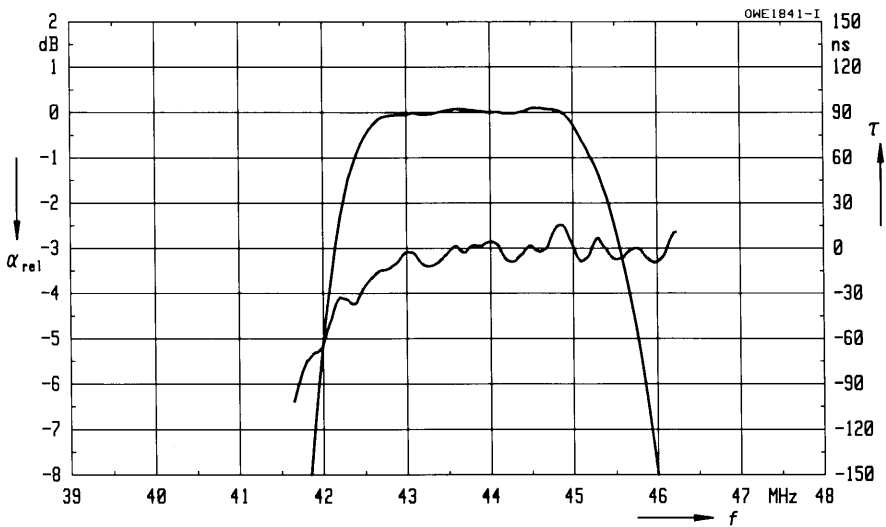
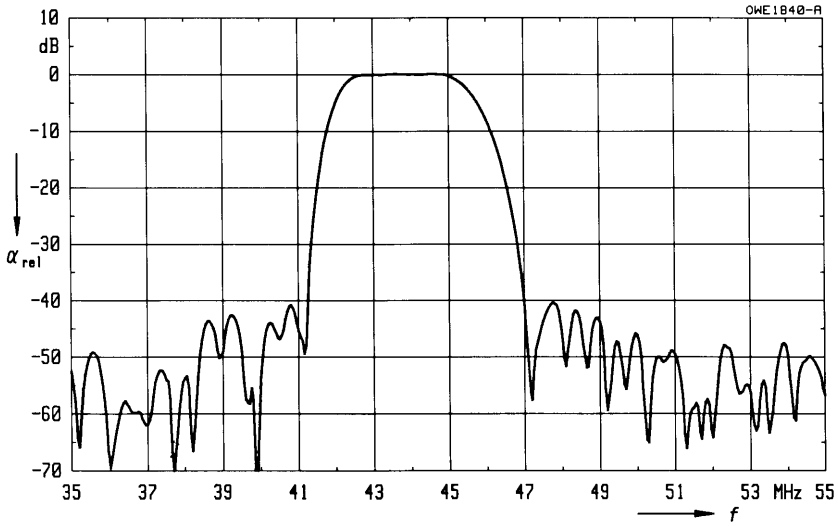

Standard

- M
Japan

Features

- TV IF filter with Nyquist slope and sound suppression
- High color carrier level
- Constant group delay

Terminals

- Tinned CuFe alloy

Plastic package **SIP 5 K**

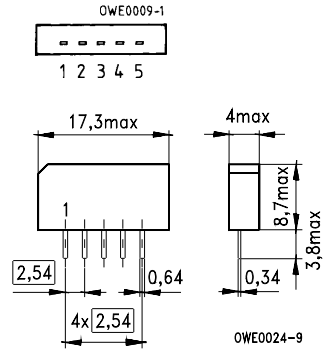

Dimensions in mm, approx. weight 1,0 g

Pin configuration

- 1 Input
- 2 Input – ground
- 3 Chip carrier – ground
- 4 Output
- 5 Output

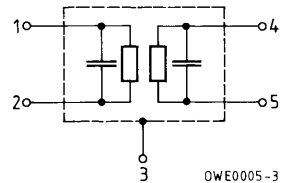

Type	Ordering code	Marking
N 3954 M	B39588-N3954-M100	Type, date code, pin 1

Maximum ratings

Ambient temperature	T_A	- 25/+ 65	°C	—
Storage temperature	T_{stg}	- 25/+ 85	°C	—
DC voltage	V_{DC}	12	V	between any terminals
AC voltage	V_{pp}	10	V	between any terminals

N 3954 M

58,75 MHz

Characteristics

Ambient temperature	$T_A = 25 (45) \text{ }^\circ\text{C}$
Source impedance	$Z_S = 50 \text{ } \Omega$
Load impedance	$Z_L = 2 \text{ k}\Omega \parallel 3 \text{ pF}$

		min.	typ.	max.	
Insertion attenuation	α				
Reference level for the following data	57,08 (57,00) MHz	10,6	12,1	13,6	dB
Relative attenuation	α_{rel}				
Picture carrier	58,83 (58,75) MHz	4,9	5,9	6,9	dB
Color carrier	55,25 (55,17) MHz	-0,7	0,3	1,3	dB
Sound carrier	54,33 (54,25) MHz	25,0	40,0	—	dB
Adjacent picture carrier	52,83 (52,75) MHz	44,0	50,0	—	dB
Adjacent sound carrier	60,33 (60,25) MHz	42,0	50,0	—	dB
Lower sidelobe					
45,08 ... 52,83 (45,00 ... 52,75) MHz		38,0	44,0	—	dB
Upper sidelobe					
60,33 ... 65,08 (60,25 ... 65,00) MHz		38,0	44,0	—	dB
Reflected wave signal suppression					
1,2 μs ... 6,0 μs after main pulse (test pulse: 250 ns, carrier frequency: 57,08 MHz)		42,0	48,0	—	dB
Feedthrough signal suppression					
1,3 μs ... 1,2 μs before main pulse (test pulse: 250 ns, carrier frequency: 57,08 MHz)		50,0	56,0	—	dB
Group delay ripple (p-p)	$\Delta\tau$	—	60	—	ns
Impedance at 57,08 MHz					
Input: $Z_{IN} = R_{IN} \parallel C_{IN}$		—	0,8 \parallel 11,8	—	$\text{k}\Omega \parallel \text{pF}$
Output: $Z_{OUT} = R_{OUT} \parallel C_{OUT}$		—	0,6 \parallel 3,0	—	$\text{k}\Omega \parallel \text{pF}$
Temperature coefficient of frequency	TC_f	—	-72	—	ppm/K

Frequency response

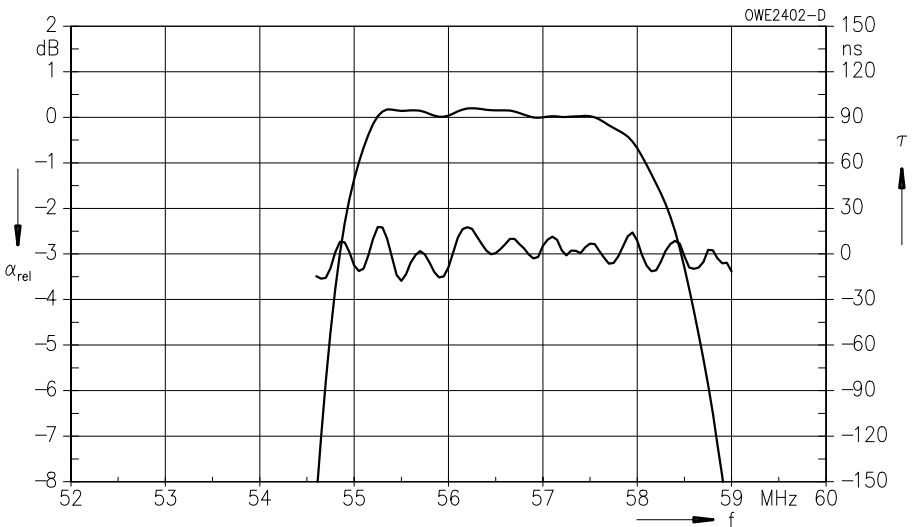
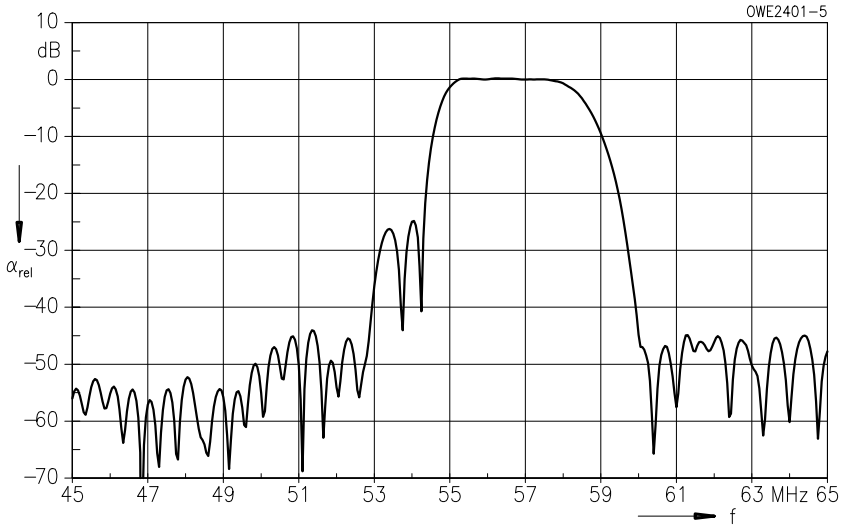



Siemens Matsushita Components

European technology center for
ceramic components

There when you need us

This is an organization that's proven its worth. Because it stands for more customer proximity and thus better service. Here you get information straight from the source, implementation of the latest technologies and products that match the market. Concentration of resources means that design engineers and production engineers are working side by side. And SCS warehousing directly at the plant ensures fastest possible delivery.



SCS – dependable, fast and competent

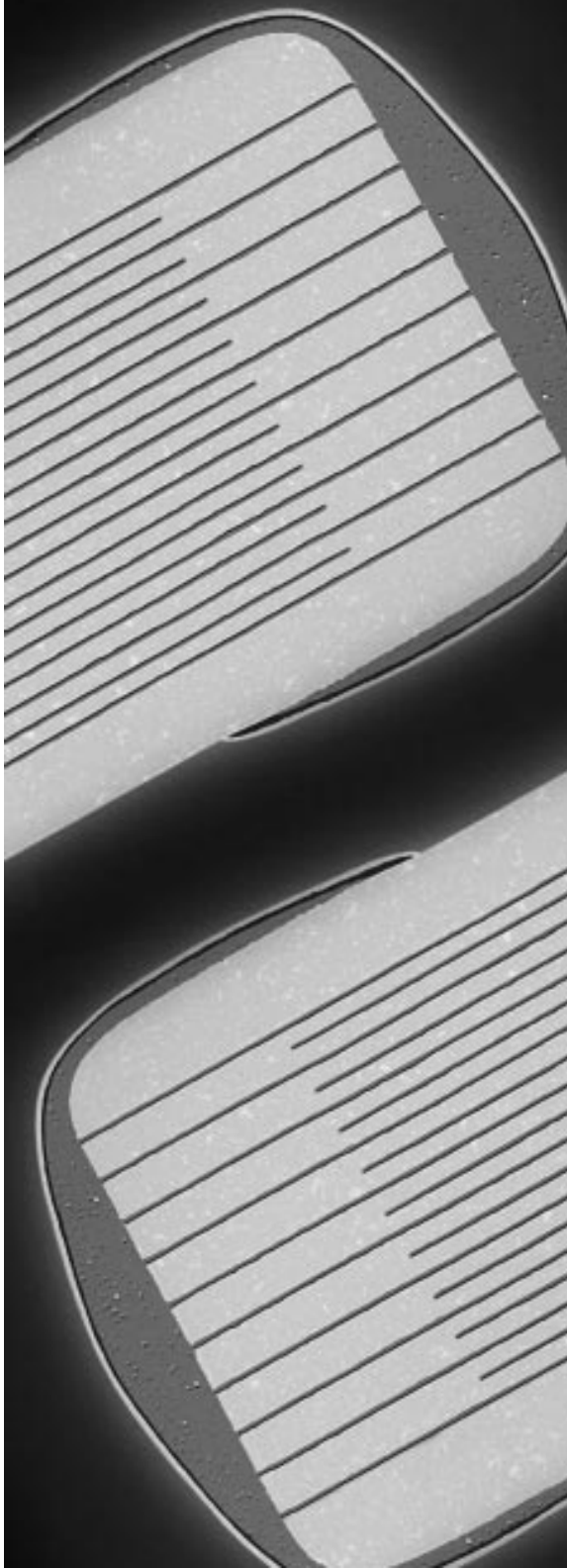

IF Filters for Audio Applications

Survey

Sound carrier MHz	Picture-to- sound carrier distance MHz	Picture carrier level ¹⁾ dB	Standard ²⁾	Package	Type	Page ³⁾
31,50 ... 32,50	5,5 ... 6,5	- 56 ⁴⁾	D/K, I, B/G	SIP 5 K ⁵⁾	K 9455 M	219
31,50 ... 33,50	4,5 ... 6,5	0	D/K, I, B/G, M/N	SIP 5 K	K 9252 M	#
	4,5 ... 6,5	- 52 ⁴⁾	D/K, I, B/G, M/N	SIP 5 K	K 9352 M	#
32,40	6,5	- 48 ⁴⁾	L	SIP 5 K	L 9360 M	#
	6,5	- 49 ⁴⁾	L	SIP 5 K	L 9362 M	223
	6,5	- 45 ⁴⁾	L	SIP 5 K ⁵⁾	L 9453 M	#
	6,5	- 57 ⁴⁾	L NICAM	SIP 5 K ⁵⁾	L 9454 M	225
	6,5	- 45 ⁴⁾	L NICAM	SIP 5 K ⁵⁾	L 9455 M	#
	6,5	- 48 ⁴⁾	L	SIP 5 K ⁵⁾	L 9456 M	228
	6,5	- 54 ⁴⁾	L	SIP 5 K ⁵⁾	L 9460 M	#
	6,5	- 50 ⁴⁾	L	SIP 5 K ⁵⁾	L 9461 M	#
32,40 ... 32,90	6,0 ... 6,5	- 50 ⁴⁾	D/K, L, I	SIP 5 K ⁵⁾	K 9460 M	#
	6,0 ... 6,5	- 49 ⁴⁾	D/K, L, I NICAM	SIP 5 K ⁵⁾	K 9463 M	#
32,40 ... 33,40	5,5 ... 6,5	0	D/K, I, B/G	SIP 5 K	K 9260 M	231
	5,5 ... 6,5	- 51 ⁴⁾	D/K, L, I, B/G	SIP 5 K	K 9350 M	#
	5,5 ... 6,5	- 49 ⁴⁾	D/K, L, I, B/G	SIP 5 K ⁵⁾	K 9453 M	233
	5,5 ... 6,5	- 42 ⁴⁾	D/K, L, I, B/G	SIP 5 K ⁵⁾	K 9462 M	#
32,40 ... 34,40	4,5 ... 6,5	0	D/K, I, B/G, M/N	SIP 5 K	K 9253 M	#
32,90	6,0	- 47 ⁴⁾	I NICAM	DIP 10 K	K 4350 K	#
	6,0	- 57 ⁴⁾	I NICAM	SIP 5 K	K 9353 M	#
33,40	5,5	0	B/G NICAM	SIP 5 K	G 9251 M	#
	5,5	- 55 ⁴⁾	B/G, L NICAM	SIP 5 K	G 9353 M	237
	5,5	- 54 ⁴⁾	B/G, L NICAM	DIP 10 K	K 4350 K	#
	5,5	- 56 ⁴⁾	B/G, L NICAM	SIP 5 K ⁵⁾	K 9460 M	#
	5,5	- 44 ⁴⁾	B/G, L NICAM	SIP 5 K ⁵⁾	K 9463 M	#
33,50	6,0	0	I NICAM	SIP 5 K	J 9250 M	#
	4,5	- 56 ⁴⁾	M/N	SIP 5 K ⁵⁾	K 9455 M	219
34,40	4,5	- 41 ⁴⁾	M/N	SIP 5 K ⁵⁾	K 9461 M	#
	4,5	- 48 ⁴⁾	M/N	SIP 5 K ⁵⁾	K 9462 M	#
39,20	- 6,5	- 60 ⁴⁾	L	SIP 5 K	L 9361 M	#

continued on next page

1) Typ., referred to filter roof

2) For explanation of standards see individual data sheets or index on page [349](#)

3) Filters marked by the sign # are only listed in the survey. Detailed information on these types on request.

4) Only sound transmission

5) Pin configuration different from standard package

IF Filters for Audio Applications

Survey

Sound carrier MHz	Picture-to- sound carrier distance MHz	Picture carrier level ¹⁾ dB	Standard ²⁾	Package	Type	Page ³⁾
39,90	- 6,5	- 51 ⁴⁾	L NICAM	SIP 5 K ⁵⁾	L 9455 M	#
	- 6,5	- 42 ⁴⁾	L	SIP 5 K ⁵⁾	L 9460 M	#
40,40	- 6,5	- 55 ⁴⁾	L	SIP 5 K	L 9353 M	#
	- 6,5	- 62 ⁴⁾	L NICAM	SIP 5 K	L 9354 M	#
	- 6,5	- 52 ⁴⁾	L	SIP 5 K ⁵⁾	L 9453 M	#
	- 6,5	- 50 ⁴⁾	L NICAM	SIP 5 K ⁵⁾	L 9454 M	225
	- 6,5	- 50 ⁴⁾	L	SIP 5 K ⁵⁾	L 9456 M	228
	- 6,5	- 52 ⁴⁾	L	SIP 5 K ⁵⁾	K 9453 M	233
	- 6,5	- 52 ⁴⁾	L	SIP 5 K ⁵⁾	K 9461 M	#
41,00	- 6,5	- 52 ⁴⁾	L	SIP 5 K ⁵⁾	L 9461 M	#
41,25	4,5	0	M/N	SIP 5 K	M 9260 M	240
	4,5	- 59 ⁴⁾	M/N	SIP 5 K	M 9352 M	242
54,25	4,5	0	M	SIP 5 K	N 9260 M	#
	4,5	- 50 ⁴⁾	M	SIP 5 K	N 9350 M	245

1) Typ., referred to filter roof

2) For explanation of standards see individual data sheets or index on page [349](#)

3) Filters marked by the sign # are only listed in the survey. Detailed information on these types on request.

4) Only sound transmission

5) Pin configuration different from standard package

Standard

- D/K-OIRT
Eastern Standard
- I
Great Britain
- B/G-CCIR
Europe partly
- M/N-FCC
USA

Features

- TV IF audio filter with two channels
- Channel 1 (B/G, D/K, I) with pass band for sound carriers between 31,95 MHz and 32,50 MHz
- Channel 2 (M/N) with pass band for sound carrier at 33,50 MHz

Terminals

- Tinned CuFe alloy

Pin configuration

- 1 Input – channel 1 / Input – ground
- 2 Input – ground / Input – channel 2
- 3 Chip carrier – ground
- 4 Output
- 5 Output

Plastic package **SIP 5 K**

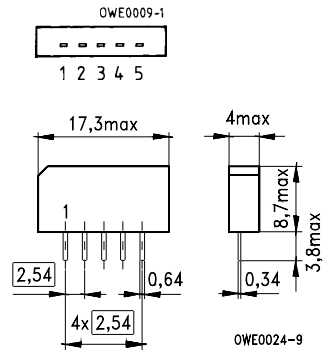

Dimensions in mm, approx. weight 1,0 g

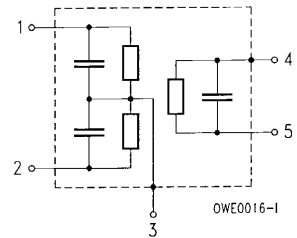

Type	Ordering code	Marking
K 9455 M	B39380-K9455-M100	Type, date code, pin 1

Maximum ratings

Ambient temperature	T_A	- 25/+ 65	°C	—
Storage temperature	T_{stg}	- 25/+ 85	°C	—
DC voltage	V_{DC}	12	V	between any terminals
AC voltage	V_{pp}	10	V	between any terminals

K 9455 M

38,00 MHz

Characteristics of channel 1

Ambient temperature $T_A = 25\text{ °C}$
 Source impedance $Z_S = 50\ \Omega$
 Load impedance $Z_L = 2\text{ k}\Omega \parallel 3\text{ pF}$

		min.	typ.	max.	
Insertion attenuation					
	α				
Reference level for the following data	32,50 MHz	12,6	14,1	15,6	dB
Relative attenuation					
	α_{rel}				
Sound carrier	31,45 MHz	- 1,8	- 0,8	0,2	dB
	31,50 MHz	- 1,8	- 0,8	0,2	dB
	32,00 MHz	- 1,2	- 0,2	0,8	dB
Picture carrier	38,00 MHz	44,0	56,0	—	dB
Color carrier	33,57 MHz	32,0	48,0	—	dB
Adjacent picture carrier	30,00 MHz	42,0	56,0	—	dB
Adjacent sound carrier	39,50 MHz	42,0	54,0	—	dB
	40,00 MHz	40,0	46,0	—	dB
	40,50 MHz	39,0	45,0	—	dB
Lower sidelobe	25,00 ... 30,00 MHz	36,0	42,0	—	dB
Upper sidelobe	38,00 ... 45,00 MHz	38,0	44,0	—	dB
Impedance at 32,50 MHz					
	Input: $Z_{IN} = R_{IN} \parallel C_{IN}$	—	1,1 \parallel 10,8	—	k Ω \parallel pF
	Output: $Z_{OUT} = R_{OUT} \parallel C_{OUT}$	—	1,0 \parallel 6,3	—	k Ω \parallel pF
Temperature coefficient of frequency					
	TC_f	—	- 72	—	ppm/K

Frequency response

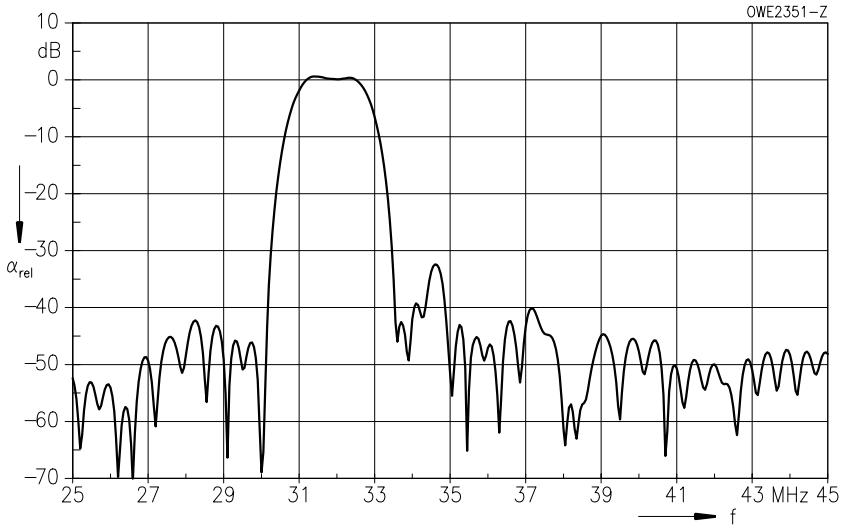

K 9455 M

38,00 MHz

Characteristics of channel 2

Ambient temperature $T_A = 25\text{ °C}$
 Source impedance $Z_S = 50\ \Omega$
 Load impedance $Z_L = 2\text{ k}\Omega \parallel 3\text{ pF}$

		min.	typ.	max.	
Insertion attenuation					
	α				
Reference level for the following data	33,50 MHz	12,8	14,3	15,8	dB
Relative attenuation					
	α_{rel}				
Picture carrier	38,00 MHz	42,0	56,0	—	dB
Color carrier	34,42 MHz	30,0	41,0	—	dB
Adjacent picture carrier	32,00 MHz	40,0	54,0	—	dB
Adjacent sound carrier	39,50 MHz	42,0	56,0	—	dB
Lower sidelobe	25,00 ... 32,00 MHz	25,0	30,0	—	dB
Upper sidelobe	38,00 ... 45,00 MHz	35,0	41,0	—	dB
Impedance at 33,50 MHz					
	Input: $Z_{IN} = R_{IN} \parallel C_{IN}$	—	0,6 \parallel 13,4	—	k Ω \parallel pF
	Output: $Z_{OUT} = R_{OUT} \parallel C_{OUT}$	—	1,4 \parallel 5,4	—	k Ω \parallel pF
Temperature coefficient of frequency					
	TC_f	—	-72	—	ppm/K

Frequency response

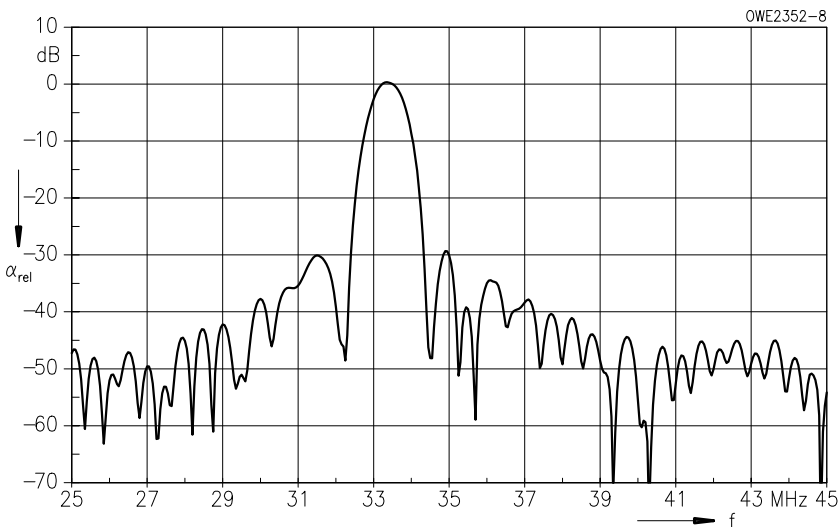

Standard

- L
France

Features

- TV IF audio filter with pass band for sound carrier at 32,40 MHz
- Highly suppressed NICAM sound carrier

Terminals

- Tinned CuFe alloy

Plastic package **SIP 5 K**

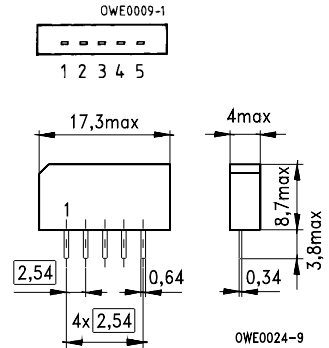

Dimensions in mm, approx. weight 1,0 g

Pin configuration

- 1 Input
- 2 Input – ground
- 3 Chip carrier – ground
- 4 Output
- 5 Output

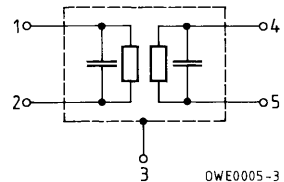

Type	Ordering code	Marking
L 9362 M	B39389-L9362-M100	Type, date code, pin 1

Maximum ratings

Ambient temperature	T_A	- 25/+ 65	°C	—
Storage temperature	T_{stg}	- 25/+ 85	°C	—
DC voltage	V_{DC}	12	V	between any terminals
AC voltage	V_{pp}	10	V	between any terminals

L 9362 M

38,90 MHz

Characteristics

Ambient temperature $T_A = 25\text{ °C}$
 Source impedance $Z_S = 50\ \Omega$
 Load impedance $Z_L = 2\text{ k}\Omega \parallel 3\text{ pF}$

		min.	typ.	max.	
Insertion attenuation	α				
Reference level for the following data	32,40 MHz	4,0	5,5	7,0	dB
Relative attenuation	α_{rel}				
Picture carrier	38,90 MHz	43,0	49,0	—	dB
NICAM sound carrier	33,05 MHz	17,0	20,0	—	dB
	34,47 MHz	38,0	57,0	—	dB
Adjacent picture carrier	30,90 MHz	42,0	51,0	—	dB
Adjacent sound carrier	40,40 MHz	50,0	67,0	—	dB
Lower sidelobe	25,00 ... 30,90 MHz	33,0	37,0	—	dB
Upper sidelobe	38,90 ... 45,00 MHz	42,0	49,0	—	dB
Impedance at 32,40 MHz					
Input: $Z_{IN} = R_{IN} \parallel C_{IN}$		—	0,2 \parallel 11,6	—	k Ω \parallel pF
Output: $Z_{OUT} = R_{OUT} \parallel C_{OUT}$		—	2,6 \parallel 3,4	—	k Ω \parallel pF
Temperature coefficient of frequency	TC_f	—	-72	—	ppm/K

Frequency response

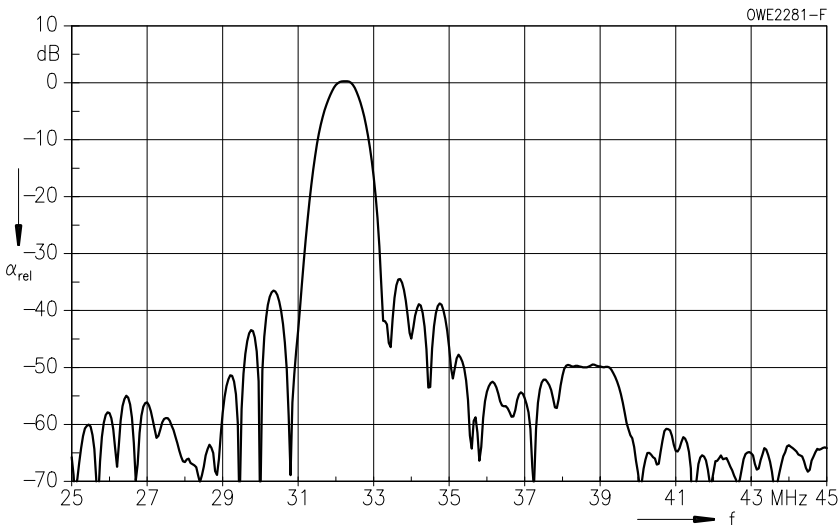

Standard

- L, L'
- France

Features

- TV IF audio filter with two channels
- Channel 1 with pass band for sound carriers at 40,40 MHz (L') and 39,75 MHz (L' NICAM)
- Channel 2 with pass band for sound carriers at 32,40 MHz (L) and 33,05 MHz (L NICAM)

Terminals

- Tinned CuFe alloy

Plastic package **SIP 5 K**

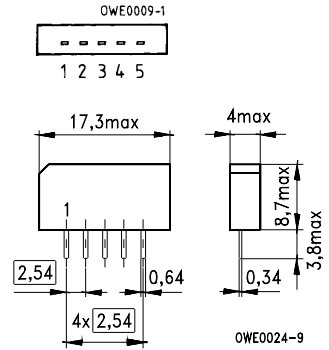

Dimensions in mm, approx. weight 1,0 g

Pin configuration

- 1 Input – channel 1 / Input – ground
- 2 Input – ground / Input – channel 2
- 3 Chip carrier – ground
- 4 Output
- 5 Output

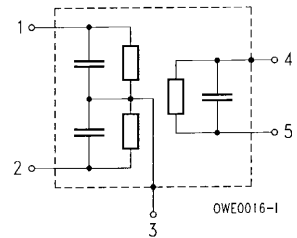

Type	Ordering code	Marking
L 9454 M	B39389-L9454-M100	Type, date code, pin 1

Maximum ratings

Ambient temperature	T_A	- 25/+ 65	°C	—
Storage temperature	T_{stg}	- 25/+ 85	°C	—
DC voltage	V_{DC}	12	V	between any terminals
AC voltage	V_{pp}	10	V	between any terminals

L 9454 M

33,90/38,90 MHz

Characteristics of channel 1

Ambient temperature $T_A = 25\text{ °C}$
 Source impedance $Z_S = 50\ \Omega$
 Load impedance $Z_L = 2\text{ k}\Omega \parallel 3\text{ pF}$

		min.	typ.	max.	
Insertion attenuation	α				
Reference level for the following data	40,40 MHz	14,0	15,5	17,0	dB
Relative attenuation	α_{rel}				
	39,75 MHz	-1,3	-0,3	0,7	dB
	38,40 MHz	27,0	37,0	—	dB
Picture carrier	33,90 MHz	40,0	50,0	—	dB
Adjacent picture carrier	41,90 MHz	31,0	37,0	—	dB
Adjacent sound carrier	32,40 MHz	36,0	43,0	—	dB
Lower sidelobe	25,00 ... 33,90 MHz	33,0	39,0	—	dB
Upper sidelobe	41,90 ... 45,00 MHz	30,0	37,0	—	dB
Group delay ripple (p-p)	$\Delta\tau$	—	50	—	ns
Impedance at 40,40 MHz					
Input:	$Z_{IN} = R_{IN} \parallel C_{IN}$	—	0,8 \parallel 10,2	—	k Ω \parallel pF
Output:	$Z_{OUT} = R_{OUT} \parallel C_{OUT}$	—	2,5 \parallel 5,0	—	k Ω \parallel pF
Temperature coefficient of frequency	TC_f	—	-72	—	ppm/K

Frequency response

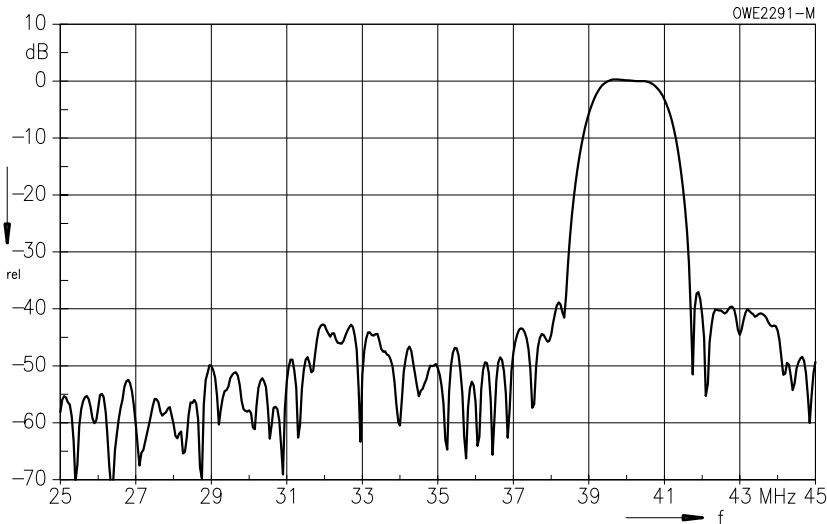

Characteristics of channel 2

Ambient temperature $T_A = 25\text{ °C}$
 Source impedance $Z_S = 50\ \Omega$
 Load impedance $Z_L = 2\text{ k}\Omega \parallel 3\text{ pF}$

		min.	typ.	max.	
Insertion attenuation	α				
Reference level for the following data	32,40 MHz	13,1	14,6	16,1	dB
Relative attenuation	α_{rel}				
	33,05 MHz	- 0,7	0,3	1,3	dB
	34,40 MHz	27,0	34,0	—	dB
Picture carrier	38,90 MHz	40,0	57,0	—	dB
Adjacent picture carrier	30,90 MHz	37,0	47,0	—	dB
Adjacent sound carrier	40,40 MHz	37,0	43,0	—	dB
Lower sidelobe	25,00 ... 30,90 MHz	37,0	45,0	—	dB
Upper sidelobe	38,90 ... 45,00 MHz	34,0	39,0	—	dB
Group delay ripple (p-p)	$\Delta\tau$	—	50	—	ns
Impedance at 32,40 MHz					
Input:	$Z_{IN} = R_{IN} \parallel C_{IN}$	—	1,5 \parallel 10,3	—	k Ω \parallel pF
Output:	$Z_{OUT} = R_{OUT} \parallel C_{OUT}$	—	1,9 \parallel 6,4	—	k Ω \parallel pF
Temperature coefficient of frequency	TC_f	—	- 72	—	ppm/K

Frequency response

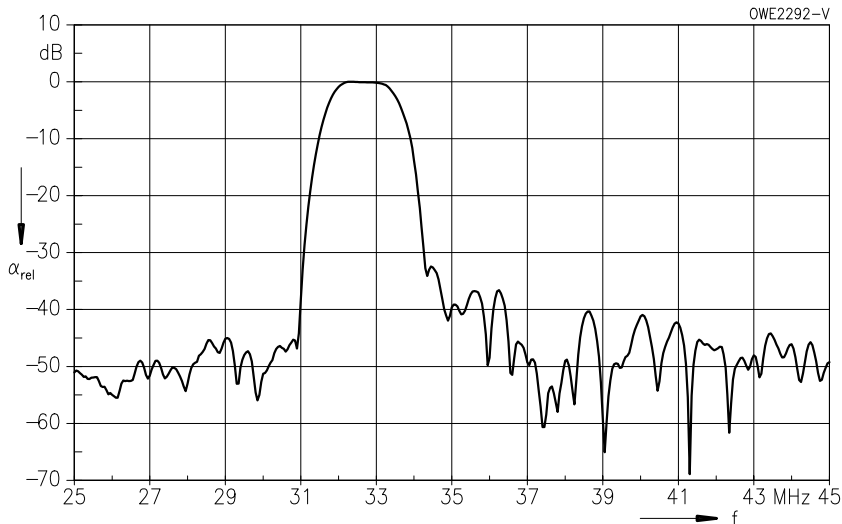

Standard

- L, L'
- France

Features

- TV IF audio filter with two channels
- Channel 1 (L') with pass band for sound carrier at 40,40 MHz
- Channel 2 (L) with pass band for sound carrier at 32,40 MHz

Terminals

- Tinned CuFe alloy

Plastic package **SIP 5 K**

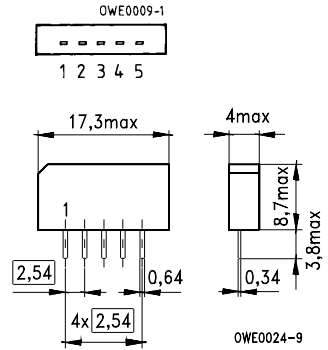

Dimensions in mm, approx. weight 1,0 g

Pin configuration

- 1 Input – channel 1
- 2 Input – channel 2
- 3 Chip carrier – ground
- 4 Output
- 5 Output

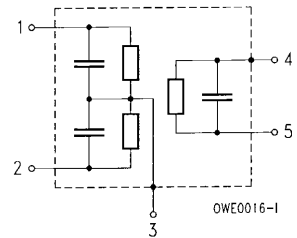

Type	Ordering code	Marking
L 9456 M	B39389-L9456-M100	Type, date code, pin 1

Maximum ratings

Ambient temperature	T_A	- 25/+ 65	°C	—
Storage temperature	T_{stg}	- 25/+ 85	°C	—
DC voltage	V_{DC}	12	V	between any terminals
AC voltage	V_{pp}	10	V	between any terminals

Characteristics of channel 1

Ambient temperature $T_A = 25\text{ }^\circ\text{C}$
 Source impedance $Z_S = 50\ \Omega$
 Load impedance $Z_L = 2\ \text{k}\Omega \parallel 3\ \text{pF}$

		min.	typ.	max.	
Insertion attenuation					
	α				
Reference level for the following data	40,40 MHz	12,6	14,1	15,6	dB
Relative attenuation					
	α_{rel}				
NICAM sound carrier	39,75 MHz	12,0	18,0	—	dB
Picture carrier	33,90 MHz	42,0	50,0	—	dB
Adjacent picture carrier	41,90 MHz	34,0	42,0	—	dB
Adjacent sound carrier	32,40 MHz	39,0	48,0	—	dB
Lower sidelobe	25,00 ... 38,40 MHz	33,0	38,0	—	dB
Upper sidelobe	41,90 ... 45,00 MHz	32,0	38,0	—	dB
Impedance at 40,40 MHz					
Input:	$Z_{\text{IN}} = R_{\text{IN}} \parallel C_{\text{IN}}$	—	0,9 \parallel 10,8	—	k Ω \parallel pF
Output:	$Z_{\text{OUT}} = R_{\text{OUT}} \parallel C_{\text{OUT}}$	—	1,5 \parallel 7,2	—	k Ω \parallel pF
Temperature coefficient of frequency					
	TC_f	—	-72	—	ppm/K

Frequency response

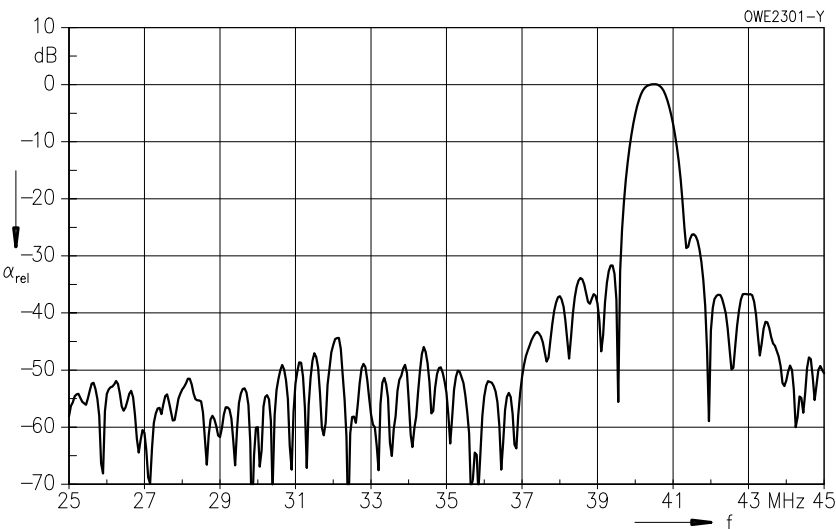

L 9456 M

33,90/38,90 MHz

Characteristics of channel 2

Ambient temperature $T_A = 25\text{ °C}$
 Source impedance $Z_S = 50\ \Omega$
 Load impedance $Z_L = 2\text{ k}\Omega \parallel 3\text{ pF}$

		min.	typ.	max.	
Insertion attenuation					
	α				
Reference level for the following data	32,40 MHz	12,8	14,3	15,8	dB
Relative attenuation					
	α_{rel}				
NICAM sound carrier	33,05 MHz	15,0	20,0	—	dB
Picture carrier	38,90 MHz	38,0	48,0	—	dB
Adjacent picture carrier	30,90 MHz	38,0	52,0	—	dB
Adjacent sound carrier	40,40 MHz	36,0	41,0	—	dB
Lower sidelobe	25,00 ... 30,90 MHz	33,0	38,0	—	dB
Upper sidelobe	34,40 ... 45,00 MHz	32,0	38,0	—	dB
Impedance at 32,40 MHz					
	Input: $Z_{IN} = R_{IN} \parallel C_{IN}$	—	1,1 \parallel 9,5	—	k Ω \parallel pF
	Output: $Z_{OUT} = R_{OUT} \parallel C_{OUT}$	—	2,8 \parallel 6,5	—	k Ω \parallel pF
Temperature coefficient of frequency					
	TC_f	—	-72	—	ppm/K

Frequency response

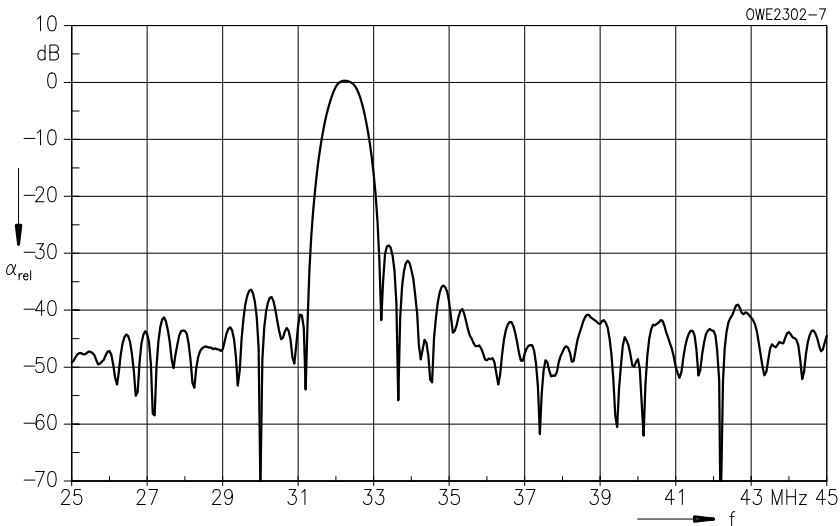

Standard

- D/K-OIRT
Eastern Standard
- I
Great Britain
- B/G-CCIR
Europe partly

Features

- TV IF audio filter with pass bands for picture carrier and sound carriers between 31,95 MHz and 33,40 MHz

Terminals

- Tinned CuFe alloy

Plastic package **SIP 5 K**

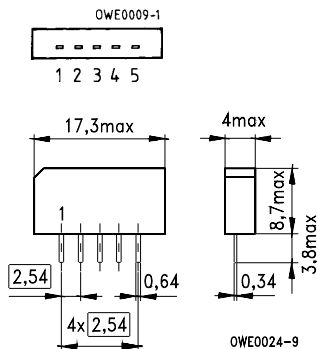

Dimensions in mm, approx. weight 1,0 g

Pin configuration

- 1 Input
- 2 Input – ground
- 3 Chip carrier – ground
- 4 Output
- 5 Output

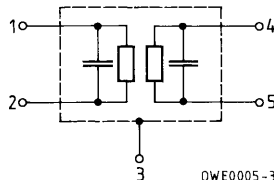

Type	Ordering code	Marking
K 9260 M	B39389-K9260-M100	Type, date code, pin 1

Maximum ratings

Ambient temperature	T_A	- 25/+ 65	°C	—
Storage temperature	T_{stg}	- 25/+ 85	°C	—
DC voltage	V_{DC}	12	V	between any terminals
AC voltage	V_{pp}	10	V	between any terminals

K 9260 M

38,90 MHz

Characteristics

Ambient temperature $T_A = 25\text{ °C}$
 Source impedance $Z_S = 50\ \Omega$
 Load impedance $Z_L = 2\text{ k}\Omega \parallel 3\text{ pF}$

		min.	typ.	max.	
Insertion attenuation	α				
Reference level for the following data	38,90 MHz	16,8	18,3	19,8	dB
Relative attenuation	α_{rel}				
Sound carrier	32,90 MHz	-0,9	0,1	1,1	dB
	32,35 MHz	-1,4	-0,4	0,6	dB
	33,40 MHz	-0,9	0,1	1,1	dB
Color carrier	34,47 MHz	25,0	32,0	—	dB
Adjacent picture carrier	30,90 MHz	37,0	45,0	—	dB
Adjacent sound carrier	40,90 MHz	38,0	51,0	—	dB
	40,35 MHz	35,0	48,0	—	dB
Lower sidelobe	25,00 ... 30,90 MHz	32,0	38,0	—	dB
Upper sidelobe	38,90 ... 45,00 MHz	32,0	38,0	—	dB
Impedance at 38,90 MHz					
Input: $Z_{IN} = R_{IN} \parallel C_{IN}$		—	2,0 \parallel 10,6	—	k Ω \parallel pF
Output: $Z_{OUT} = R_{OUT} \parallel C_{OUT}$		—	3,8 \parallel 3,6	—	k Ω \parallel pF
Temperature coefficient of frequency	TC_f	—	-72	—	ppm/K

Frequency response

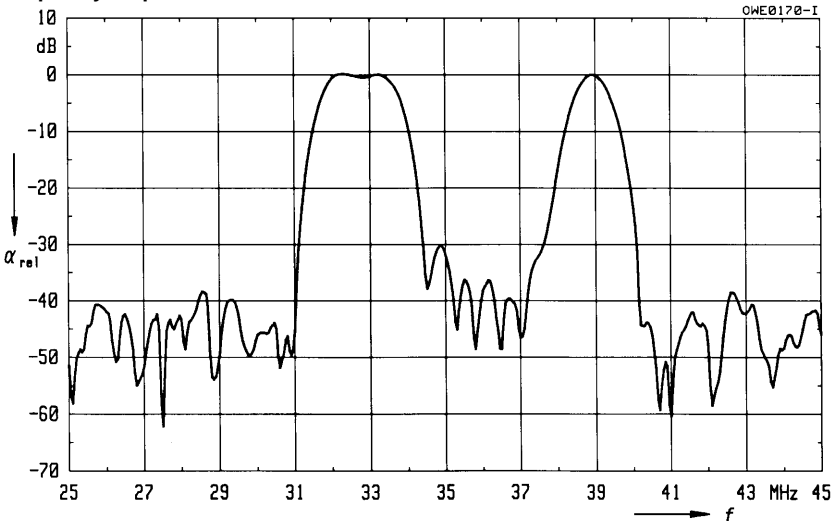

Standard

- L/L' France
- D/K-OIRT Eastern Standard
- I Great Britain
- B/G-CCIR Europe partly

Features

- TV IF audio filter with two channels
- Channel 1 (L') with pass band for sound carrier at 40,40 MHz
- Channel 2 (L, D/K, I, B/G) with pass band for sound carriers between 32,40 MHz and 33,40 MHz

Terminals

- Tinned CuFe alloy

Pin configuration

- 1 Input – channel 1 / Input – ground
- 2 Input – ground / Input – channel 2
- 3 Chip carrier – ground
- 4 Output
- 5 Output

Plastic package **SIP 5 K**

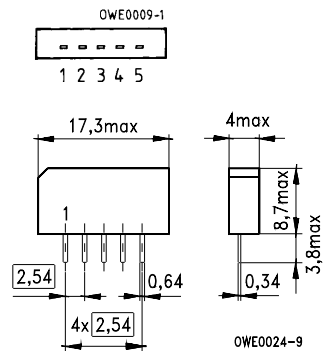

Dimensions in mm, approx. weight 1,0 g

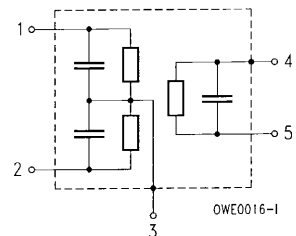

Type	Ordering code	Marking
K 9453 M	B39389-K9453-M100	Type, date code, pin 1

Maximum ratings

Ambient temperature	T_A	- 25/+ 65	°C	—
Storage temperature	T_{stg}	- 25/+ 85	°C	—
DC voltage	V_{DC}	12	V	between any terminals
AC voltage	V_{pp}	10	V	between any terminals

K 9453 M

33,90/38,90 MHz

Characteristics of channel 1

Ambient temperature $T_A = 25\text{ °C}$
 Source impedance $Z_S = 50\ \Omega$
 Load impedance $Z_L = 2\text{ k}\Omega \parallel 3\text{ pF}$

		min.	typ.	max.	
Insertion attenuation					
	α				
Reference level for the following data	40,40 MHz	12,0	13,5	15,0	dB
Relative attenuation					
	α_{rel}				
Picture carrier	33,90 MHz	42,0	52,0		dB
	38,40 MHz	40,0	56,0		dB
Adjacent picture carrier	41,90 MHz	36,0	44,0	—	dB
Adjacent sound carrier	32,40 MHz	42,0	50,0	—	dB
Lower sidelobe	25,00 ... 38,40 MHz	38,0	46,0	—	dB
Upper sidelobe	41,90 ... 45,00 MHz	32,0	38,0	—	dB
Impedance at 40,40 MHz					
	Input: $Z_{IN} = R_{IN} \parallel C_{IN}$	—	0,8 \parallel 8,5	—	k Ω \parallel pF
	Output: $Z_{OUT} = R_{OUT} \parallel C_{OUT}$	—	2,1 \parallel 5,3	—	k Ω \parallel pF
Temperature coefficient of frequency					
	TC_f	—	-72	—	ppm/K

Frequency response

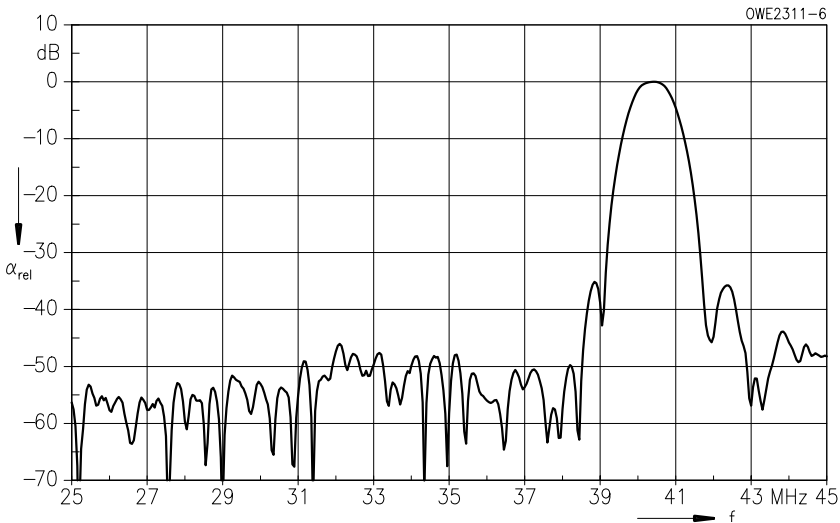

Characteristics of channel 2

Ambient temperature $T_A = 25\text{ °C}$
 Source impedance $Z_S = 50\ \Omega$
 Load impedance $Z_L = 2\text{ k}\Omega \parallel 3\text{ pF}$

		min.	typ.	max.	
Insertion attenuation					
	α				
Reference level for the following data	33,40 MHz	13,0	14,5	16,0	dB
Relative attenuation					
	α_{rel}				
Sound carrier	33,05 MHz	- 1,3	- 0,3	0,7	dB
	32,90 MHz	- 0,9	0,1	1,1	dB
	32,40 MHz	- 1,2	- 0,2	0,8	dB
Picture carrier	38,90 MHz	39,0	49,0	—	dB
Color carrier	34,47 MHz	25,0	32,0	—	dB
Adjacent picture carrier	30,90 MHz	31,0	37,0	—	dB
Adjacent sound carrier	40,40 MHz	34,0	40,0	—	dB
	40,90 MHz	36,0	43,0	—	dB
	41,40 MHz	38,0	48,0	—	dB
Lower sidelobe	25,00 ... 30,50 MHz	38,0	44,0	—	dB
Upper sidelobe	38,90 ... 45,00 MHz	32,0	37,0	—	dB
Impedance at 33,40 MHz					
	Input: $Z_{IN} = R_{IN} \parallel C_{IN}$	—	1,0 \parallel 10,1	—	k Ω \parallel pF
	Output: $Z_{OUT} = R_{OUT} \parallel C_{OUT}$	—	2,7 \parallel 6,8	—	k Ω \parallel pF
Temperature coefficient of frequency					
	TC_f	—	- 72	—	ppm/K

Frequency response curve on next page

K 9453 M
33,90/38,90 MHz

Frequency response

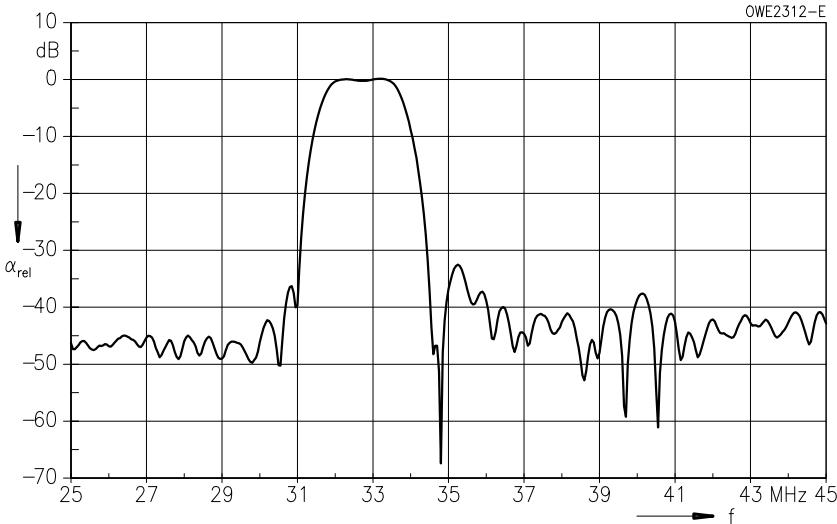

Standard

- B/G-CCIR
Germany, Europe partly
- L
France

Features

- TV IF audio filter with pass band for sound carriers at 33,40 MHz (B/G) and 33,05 MHz (B/G, L NICAM)

Terminals

- Tinned CuFe alloy

Plastic package **SIP 5 K**

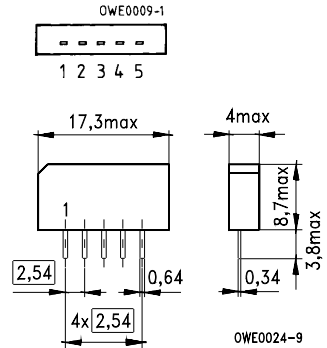

Dimensions in mm, approx. weight 1,0 g

Pin configuration

- 1 Input
- 2 Input ground
- 3 Chip carrier – ground
- 4 Output
- 5 Output

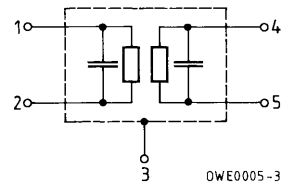

Type	Ordering code	Marking
G 9353 M	B39389-G9353-M100	Type, date code, pin 1

Maximum ratings

Ambient temperature	T_A	- 25/+ 65	°C	—
Storage temperature	T_{stg}	- 25/+ 85	°C	—
DC voltage	V_{DC}	12	V	between any terminals
AC voltage	V_{pp}	10	V	between any terminals

G 9353 M

38,90 MHz

Characteristics

Ambient temperature $T_A = 25\text{ °C}$
 Source impedance $Z_S = 50\ \Omega$
 Load impedance $Z_L = 2\text{ k}\Omega \parallel 3\text{ pF}$

		min.	typ.	max.	
Insertion attenuation	α				
Reference level for the following data	33,05 MHz	12,1	13,6	15,1	dB
Relative attenuation	α_{rel}				
Sound carrier	33,40 MHz	0,4	1,4	2,4	dB
	32,80 MHz	—	0,9	—	dB
Picture carrier	38,90 MHz	40,0	55,0	—	dB
Color carrier	34,47 MHz	26,0	34,0	—	dB
Adjacent picture carrier	UHF 30,90 MHz	31,0	36,0	—	dB
	VHF 31,90 MHz	33,0	41,0	—	dB
Adjacent sound carrier	VHF 40,40 MHz	40,0	55,0	—	dB
	UHF 41,40 MHz	40,0	56,0	—	dB
Lower sidelobe	25,00 ... 31,90 MHz	30,0	36,0	—	dB
Upper sidelobe	40,40 ... 45,00 MHz	37,0	46,0	—	dB
Group delay ripple (p-p)	$\Delta\tau$	—	40	—	ns
Impedance at 33,05 MHz					
Input: $Z_{IN} = R_{IN} \parallel C_{IN}$		—	1,2 \parallel 10,3	—	k Ω \parallel pF
Output: $Z_{OUT} = R_{OUT} \parallel C_{OUT}$		—	3,4 \parallel 2,9	—	k Ω \parallel pF
Temperature coefficient of frequency	TC_f	—	-72	—	ppm/K

Frequency response

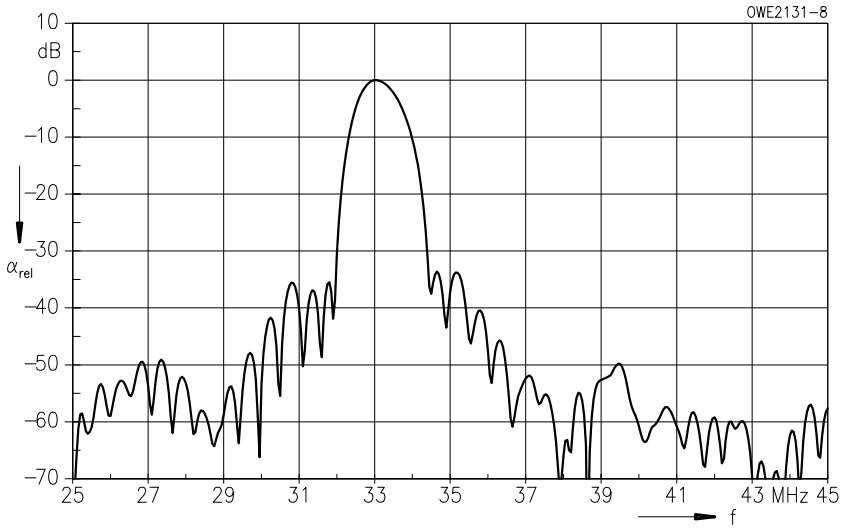

Standard

- M/N-FCC
USA

Features

- TV IF audio filter with pass bands for picture carrier and sound carrier at 41,25 MHz

Terminals

- Tinned CuFe alloy

Plastic package **SIP 5 K**

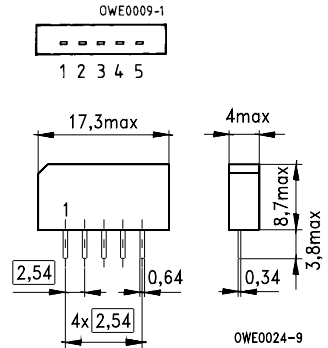

Dimensions in mm, approx. weight 1,0 g

Pin configuration

- 1 Input
- 2 Input – ground
- 3 Chip carrier – ground
- 4 Output
- 5 Output

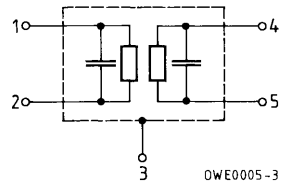

Type	Ordering code	Marking
M 9260 M	B39458-M9260-M100	Type, date code, pin 1

Maximum ratings

Ambient temperature	T_A	- 25/+ 65	°C	—
Storage temperature	T_{stg}	- 25/+ 85	°C	—
DC voltage	V_{DC}	12	V	between any terminals
AC voltage	V_{pp}	10	V	between any terminals

Characteristics

Ambient temperature $T_A = 25\text{ °C}$
 Source impedance $Z_S = 50\ \Omega$
 Load impedance $Z_L = 2\text{ k}\Omega \parallel 3\text{ pF}$

		min.	typ.	max.	
Insertion attenuation	α				
Reference level for the following data	41,25 MHz	12,9	14,4	15,9	dB
Relative attenuation	α_{rel}				
Picture carrier	45,75 MHz	- 1,0	0,0	1,0	dB
Color carrier	42,17 MHz	22,0	28,0	—	dB
Adjacent picture carrier	39,75 MHz	42,0	50,0	—	dB
Adjacent sound carrier	47,25 MHz	40,0	48,0	—	dB
Lower sidelobe	35,00 ... 39,75 MHz	40,0	46,0	—	dB
Upper sidelobe	47,25 ... 55,00 MHz	36,0	42,0	—	dB
Impedance at 41,25 MHz					
Input: $Z_{IN} = R_{IN} \parallel C_{IN}$		—	0,4 9,5	—	k Ω pF
Output: $Z_{OUT} = R_{OUT} \parallel C_{OUT}$		—	3,3 6,3	—	k Ω pF
Temperature coefficient of frequency	TC_f	—	- 72	—	ppm/K

Frequency response

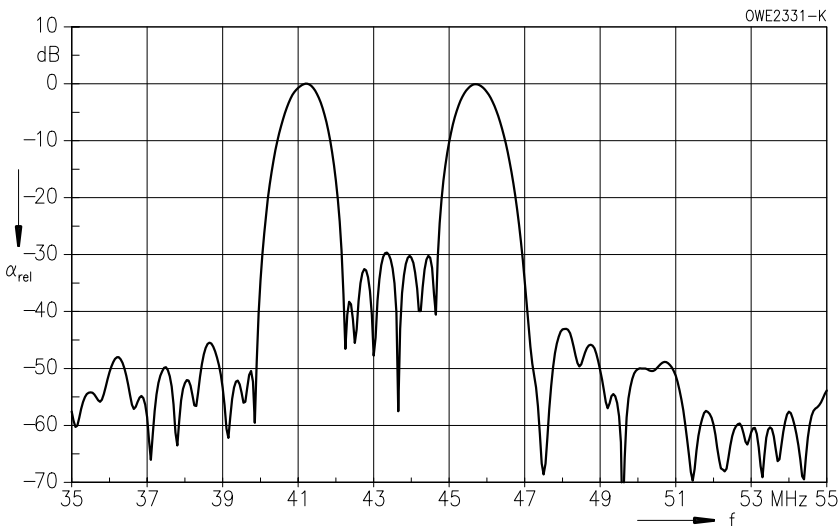

Standard

- M/N-FCC
USA

Features

- TV IF audio filter with pass band for sound carrier at 41,25 MHz

Terminals

- Tinned CuFe alloy

Plastic package **SIP 5 K**

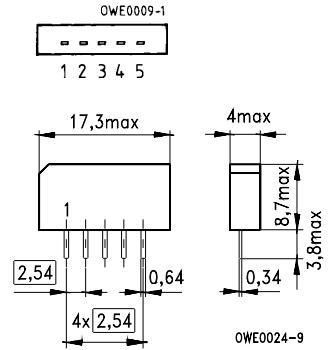

Dimensions in mm, approx. weight 1,0 g

Pin configuration

- 1 Input
- 2 Input – ground
- 3 Chip carrier – ground
- 4 Output
- 5 Output

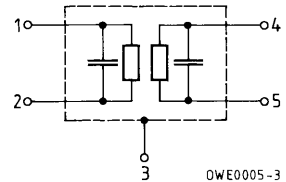

Type	Ordering code	Marking
M 9352 M	B39458-M9352-M100	Type, date code, pin 1

Maximum ratings

Ambient temperature	T_A	- 25/+ 65	°C	—
Storage temperature	T_{stg}	- 25/+ 85	°C	—
DC voltage	V_{DC}	12	V	between any terminals
AC voltage	V_{pp}	10	V	between any terminals

Characteristics

Ambient temperature $T_A = 25\text{ °C}$
 Source impedance $Z_S = 50\ \Omega$
 Load impedance $Z_L = 50\ \Omega$

		min.	typ.	max.	
Insertion attenuation	α				
Reference level for the following data	41,25 MHz	17,0	18,5	20,0	dB
Relative attenuation	α_{rel}				
	40,95 MHz	0,5	1,5	2,5	dB
	41,55 MHz	-0,3	0,7	1,7	dB
	39,17 MHz	40,0	54,0	—	dB
Picture carrier	45,75 MHz	46,0	59,0	—	dB
Color carrier	42,17 MHz	20,0	28,0	—	dB
Adjacent picture carrier	39,75 MHz	40,0	45,0	—	dB
Adjacent sound carrier	47,25 MHz	46,0	62,0	—	dB
Lower sidelobe	35,00 ... 39,75 MHz	36,0	41,0	—	dB
Upper sidelobe	45,75 ... 55,00 MHz	42,0	52,0	—	dB
Group delay ripple (p-p)	$\Delta\tau$	—	90	—	ns
Impedance at 41,25 MHz					
Input: $Z_{IN} = R_{IN} \parallel C_{IN}$		—	0,1 \parallel 24,2	—	k Ω \parallel pF
Output: $Z_{OUT} = R_{OUT} \parallel C_{OUT}$		—	1,2 \parallel 8,3	—	k Ω \parallel pF
Temperature coefficient of frequency	TC_f	—	-72	—	ppm/K

Frequency response curve on next page

M 9352 M
45,75 MHz

Frequency response

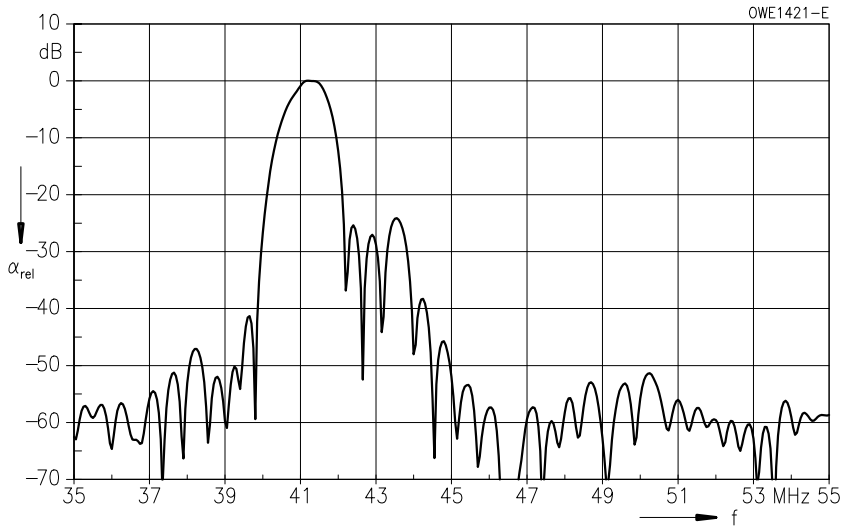

Standard

- M
Japan

Features

- TV IF audio filter with pass band for sound carrier at 54,25 MHz

Terminals

- Tinned CuFe alloy

Plastic package **SIP 5 K**

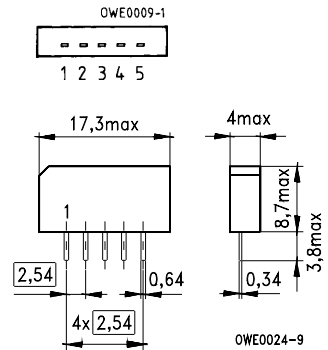

Dimensions in mm, approx. weight 1,0 g

Pin configuration

- 1 Input
- 2 Input – ground
- 3 Chip carrier – ground
- 4 Output
- 5 Output

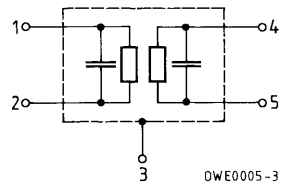

Type	Ordering code	Marking
N 9350 M	B39588-N9350-M100	Type, date code, pin 1

Maximum ratings

Ambient temperature	T_A	- 25/+ 65	°C	—
Storage temperature	T_{stg}	- 25/+ 85	°C	—
DC voltage	V_{DC}	12	V	between any terminals
AC voltage	V_{pp}	10	V	between any terminals

N 9350 M

58,75 MHz

Characteristics

Ambient temperature $T_A = 25 (45) \text{ }^\circ\text{C}$
 Source impedance $Z_S = 50 \text{ } \Omega$
 Load impedance $Z_L = 2 \text{ k}\Omega \parallel 3 \text{ pF}$

		min.	typ.	max.	
Insertion attenuation					
Reference level for the following data	54,33 (54,25) MHz α	14,7	16,2	17,7	dB
Relative attenuation					
Picture carrier	58,83 (58,75) MHz α_{rel}	38,0	50,0	—	dB
Color carrier	55,25 (55,17) MHz	26,0	32,0	—	dB
Adjacent picture carrier	52,83 (52,75) MHz	38,0	48,0	—	dB
Adjacent sound carrier	60,33 (60,25) MHz	42,0	54,0	—	dB
Lower sidelobe					
45,08 ... 52,83 (45,00 ... 52,75) MHz		30,0	36,0	—	dB
Upper sidelobe					
60,33 ... 65,08 (60,25 ... 65,00) MHz		40,0	48,0	—	dB
Impedance at 54,33 MHz					
Input: $Z_{IN} = R_{IN} \parallel C_{IN}$		—	0,8 \parallel 8,6	—	k Ω \parallel pF
Output: $Z_{OUT} = R_{OUT} \parallel C_{OUT}$		—	2,7 \parallel 2,1	—	k Ω \parallel pF
Temperature coefficient of frequency	TC_f	—	-72	—	ppm/K

Frequency response

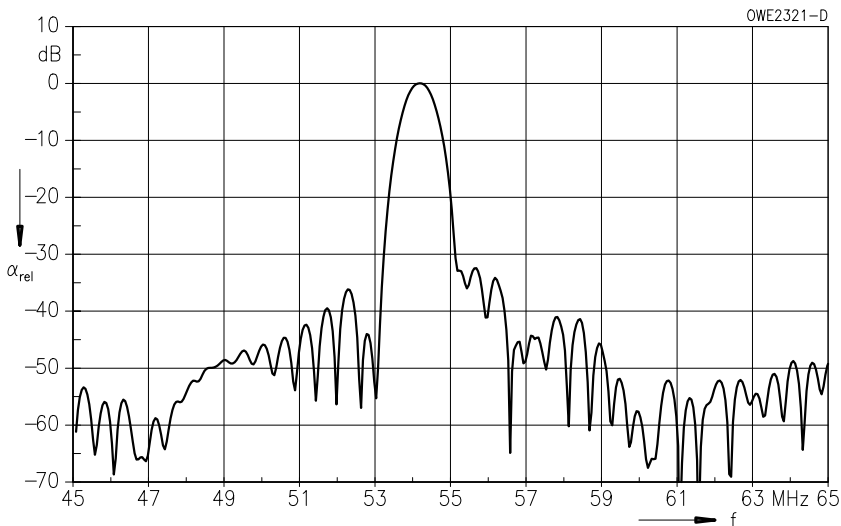

Satellite Filters

Survey

Center frequency MHz	3 dB bandwidth MHz	Insertion attenuation dB	Shunt resistors ¹⁾	Package	Type	Page ²⁾
402,78	27,0 + 31,0	24,7 + 23,4	no	TO 39	B 609	248
403,18	26,9 + 32,1 31,3	24,8 + 24,8 22,0	yes	TO 39	B 629	#
			no	TO 39	B 682	253
479,50	27,0 + 18,0 27,0 + 32,0 27,0 + 36,0 21,5 + 27,0 15,0 + 27,0	20,4 + 21,0 21,3 + 21,3 22,1 + 22,7 21,0 + 21,0 21,8 + 22,0	no	TO 39	B 611	256
			no	TO 39	B 615	#
			no	TO 39	B 619	#
			no	TO 39	B 621	#
			no	TO 39	B 625	#
480,00	33,5 + 36,1 15,7 32,0 22,5 36,2 26,6 17,6 26,6	23,2 + 22,2 18,4 20,0 19,0 21,0 20,0 19,5 18,5	yes	TO 39	B 635	261
			yes	TO 39	B 662	#
			no	TO 39	B 674	#
			no	TO 39	B 680	#
			no	TO 39	B 686	#
			yes	TO 39	B 692	266
			yes	TO 39	B 694	269
			no	TO 39	B 696	#

1) Integrated shunt resistors for improved ESD capability

2) Filters marked by the sign # are only listed in the survey. Detailed information on these types upon request.

Features

- Two-channel satellite receiver filter
- IF filter for DSB receivers
- Constant group delay

Terminals

- Gold-plated NiFeCo alloy

Metal package TO 39

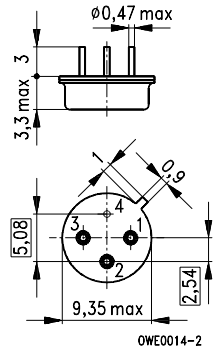

Dimensions in mm, approx. weight 1,0 g

Pin configuration

- 1 Input
- 2 Output – channel 2
- 3 Output – channel 1
- 4 Ground

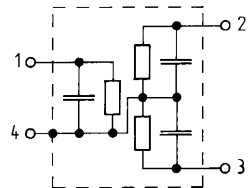

Type	Ordering code	Marking
B 609	B39401-B609-B210	Type, date code

Electrostatic Sensitive Device (ESD)

Maximum ratings

Ambient temperature	T_A	- 20/+ 80	°C	—
Storage temperature	T_{stg}	- 25/+ 85	°C	—
DC voltage	V_{DC}	0	V	between any terminals
AC voltage	V_{pp}	5	V	between any terminals

Characteristics of channel 1

Ambient temperature $T_A = 25\text{ °C}$
 Source impedance $Z_S = 50\ \Omega$
 Load impedance $Z_L = 50\ \Omega$
 Group delay aperture 0,25 MHz

				min.	typ.	max.	
Insertion attenuation	402,78 MHz	α	—	24,7	26,0	dB	
Reference level for the following data							
Pass bandwidth ($\alpha_{rel} \leq 3\text{ dB}$)		B_{3dB}	—	27,00	—	MHz	
Relative attenuation		α_{rel}					
	389,28 MHz		—	3,4	4,0	dB	
	416,28 MHz		—	2,4	4,0	dB	
Lower sidelobe	350,00 ... 372,78 MHz		30,0	42,0	—	dB	
Upper sidelobe	432,78 ... 450,00 MHz		30,0	42,5	—	dB	
Reflected wave signal suppression							
0,06 μ s ... 3,0 μ s after main pulse			40,0	52,0	—	dB	
Amplitude							
Amplitude ripple (p-p) 397,78 ... 407,78 MHz		$\Delta\alpha$	—	0,4	0,7	dB	
Group delay		τ					
Group delay ripple (p-p) 389,28 ... 416,28 MHz		$\Delta\tau$	—	6	15	ns	
Impedance at 402,78 MHz							
Input: $Z_{IN} = R_{IN} \parallel C_{IN}$			—	220 \parallel 4,7	—	$\Omega \parallel$ pF	
Output: $Z_{OUT} = R_{OUT} \parallel C_{OUT}$			—	1190 \parallel 1,7	—	$\Omega \parallel$ pF	
Temperature coefficient of frequency		TC_f	—	-86	—	ppm/K	

B 609
402,78 MHz

Frequency response

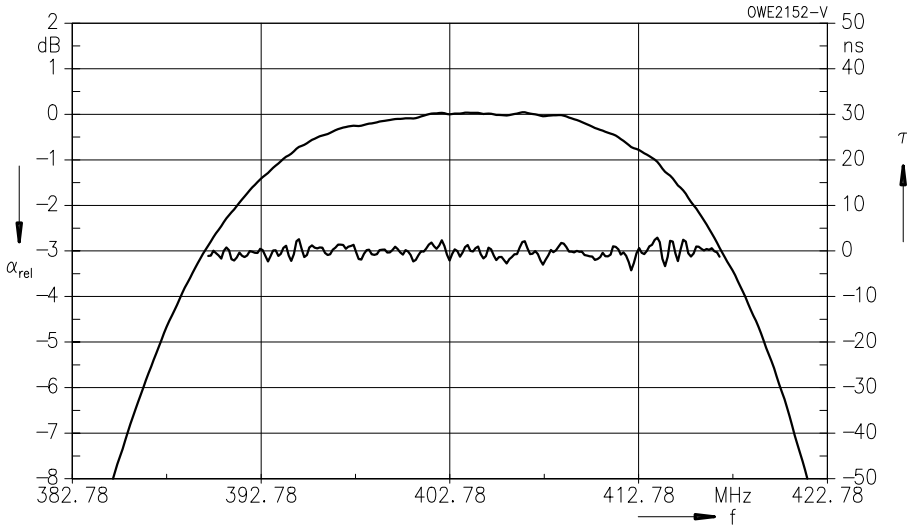
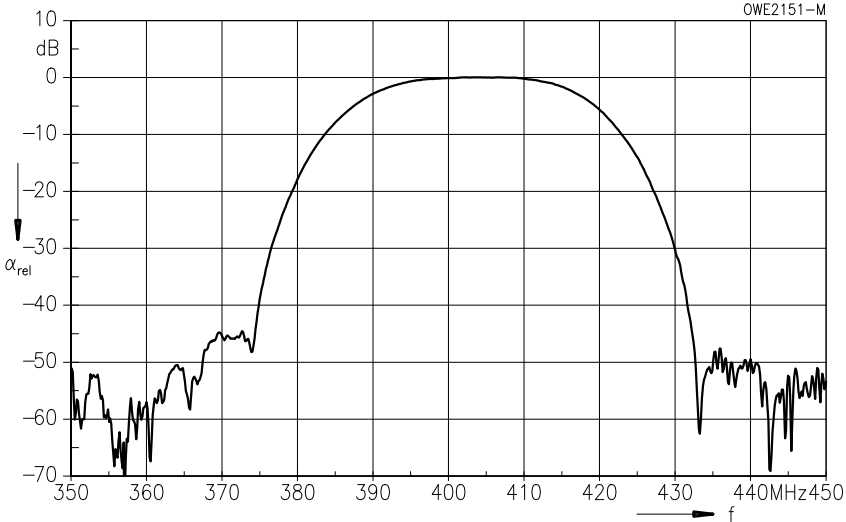

Characteristics of channel 2

Ambient temperature $T_A = 25\text{ °C}$
 Source impedance $Z_S = 50\ \Omega$
 Load impedance $Z_L = 50\ \Omega$
 Group delay aperture 0,25 MHz

				min.	typ.	max.	
Insertion attenuation	402,78 MHz	α	—	23,4	25,0	dB	
Reference level for the following data							
Pass bandwidth ($\alpha_{\text{rel}} \leq 3\text{ dB}$)		$B_{3\text{dB}}$	—	31,00	—	MHz	
Relative attenuation		α_{rel}					
	387,28 MHz		—	3,2	4,0	dB	
	418,28 MHz		—	2,3	4,0	dB	
Lower sidelobe	350,00 ... 372,78 MHz		30,0	41,0	—	dB	
Upper sidelobe	432,78 ... 450,00 MHz		30,0	37,6	—	dB	
Reflected wave signal suppression							
0,07 μs ... 3,0 μs after main pulse			40,0	51,0	—	dB	
Amplitude							
Amplitude ripple (p-p) 396,78 ... 408,78 MHz		$\Delta\alpha$	—	0,4	0,7	dB	
Group delay		τ					
Group delay ripple (p-p) 387,28 ... 418,28 MHz		$\Delta\tau$	—	6	15	ns	
Impedance at 479,50 MHz							
Output: $Z_{\text{OUT}} = R_{\text{OUT}} \parallel C_{\text{OUT}}$			—	1380 \parallel 1,6	—	$\Omega \parallel \text{pF}$	
Temperature coefficient of frequency		TC_f	—	- 86	—	ppm/K	

B 609
402,78 MHz

Frequency response

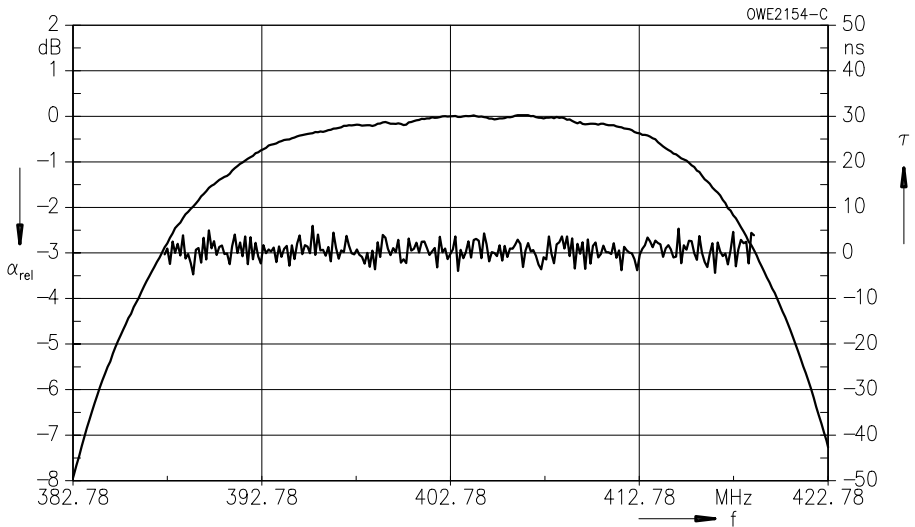
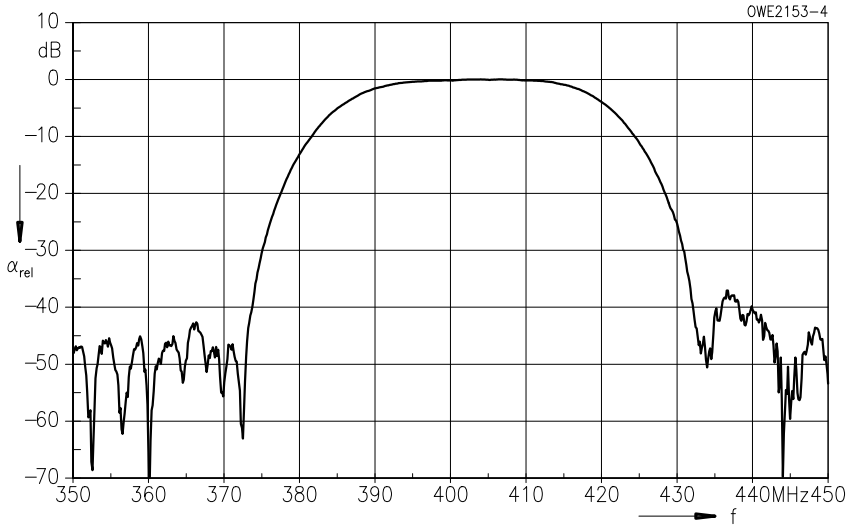

Features

- IF filter for DSB receivers
- Constant group delay
- Optimized group delay time

Terminals

- Gold-plated NiFeCo alloy

Metal package TO 39

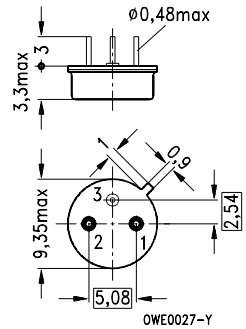

Dimensions in mm, approx. weight 1,0 g

Pin configuration

- 1 Input
- 2 Output
- 3 Ground

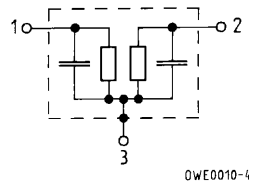

Type	Ordering code	Marking
B 682	B39401-B682-B510	Type, date code

Electrostatic Sensitive Device (ESD)

Maximum ratings

Ambient temperature	T_A	- 20/+ 80	°C	—
Storage temperature	T_{stg}	- 25/+ 85	°C	—
DC voltage	V_{DC}	0	V	between any terminals
AC voltage	V_{pp}	5	V	between any terminals

B 682

403,18 MHz

Characteristics

Ambient temperature	$T_A = 25 (35) \text{ }^\circ\text{C}$
Source impedance	$Z_S = 50 \text{ } \Omega$
Load impedance	$Z_L = 50 \text{ } \Omega$
Group delay aperture	0,25 MHz

				min.	typ.	max.	
Insertion attenuation	403,18 (402,78) MHz	α	—	22,0	24,0	dB	
Reference level for the following data							
Center frequency		f_c	402,18	403,18	404,18	MHz	
Pass bandwidth ($\alpha_{rel} \leq 3 \text{ dB}$)		B_{3dB}	30,30	31,30	32,30	MHz	
Relative attenuation		α_{rel}					
	387,67 (367,28) MHz		—	3,0	4,7	dB	
	418,70 (418,28) MHz		—	3,2	4,7	dB	
Lower sidelobe	350,35 ... 376,17 MHz (350,00 ... 375,78) MHz		36,0	40,0	—	dB	
Upper sidelobe	430,21 ... 450,45 MHz (429,78 ... 450,00) MHz		35,0	38,0	—	dB	
Reflected wave signal suppression	0,16 μs ... 3,0 μs after main pulse		40,0	48,5	—	dB	
Amplitude							
Amplitude ripple (p-p)	394,18 ... 412,18 MHz	$\Delta\alpha$	—	0,3	0,5	dB	
Group delay	403,18 MHz	τ	—	282	—	ns	
Group delay ripple (p-p)	388,17 ... 418,20 MHz	$\Delta\tau$	—	11	18	ns	
Impedance at 403,18 MHz							
	Input: $Z_{IN} = R_{IN} \parallel C_{IN}$		—	90 \parallel 5,8	—	$\Omega \parallel \text{pF}$	
	Output: $Z_{OUT} = R_{OUT} \parallel C_{OUT}$		—	730 \parallel 3,9	—	$\Omega \parallel \text{pF}$	
Temperature coefficient of frequency		TC_f	—	-86	—	ppm/K	

Frequency response

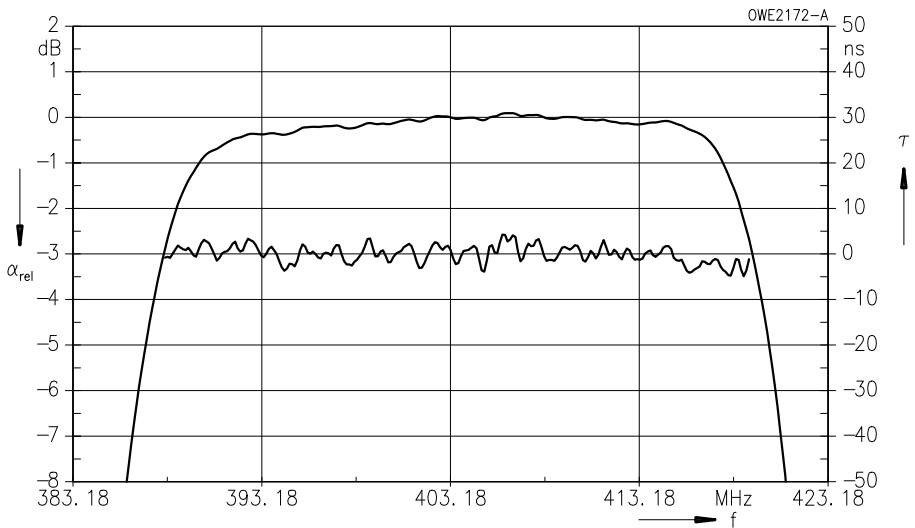
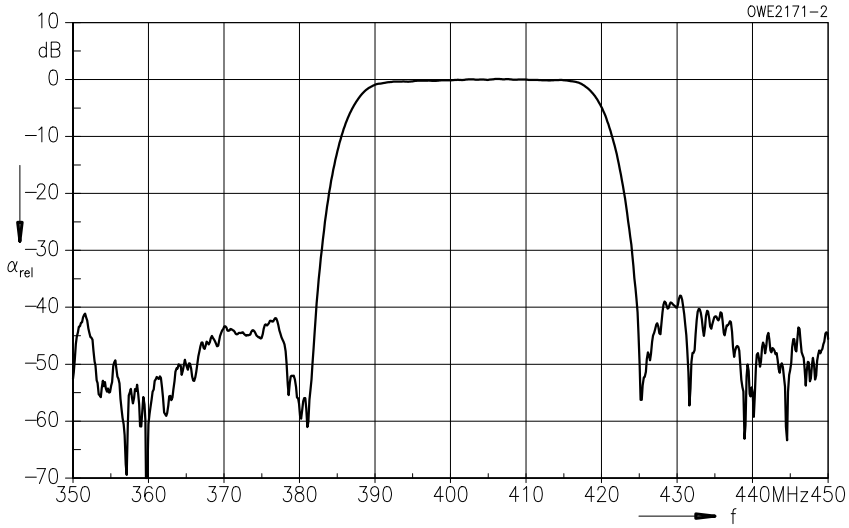

Features

- Two-channel satellite receiver filter
- IF filter for DSB receivers
- Constant group delay

Terminals

- Gold-plated NiFeCo alloy

Metal package TO 39

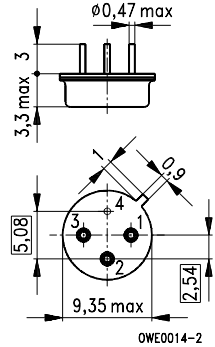

Dimensions in mm, approx. weight 1,0 g

Pin configuration

- 1 Input
- 2 Output – channel 2
- 3 Output – channel 1
- 4 Ground

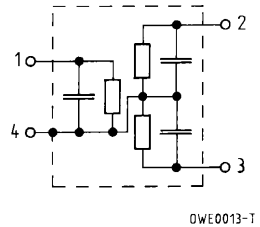

Type	Ordering code	Marking
B 611	B39481-B611-B210	Type, date code

Electrostatic Sensitive Device (ESD)

Maximum ratings

Ambient temperature	T_A	- 20/+ 80	°C	—
Storage temperature	T_{stg}	- 25/+ 85	°C	—
DC voltage	V_{DC}	0	V	between any terminals
AC voltage	V_{pp}	5	V	between any terminals

Characteristics of channel 1

Ambient temperature $T_A = 25\text{ °C}$
 Source impedance $Z_S = 50\ \Omega$
 Load impedance $Z_L = 50\ \Omega$
 Group delay aperture 0,25 MHz

				min.	typ.	max.	
Insertion attenuation	479,50 MHz	α	—	21,0	22,5	dB	
Reference level for the following data							
Center frequency		f_c	478,50	479,50	480,50	MHz	
Pass bandwidth ($\alpha_{rel} \leq 3\text{ dB}$)		B_{3dB}	—	27,00	—	MHz	
Relative attenuation		α_{rel}	—	3,3	4,5	dB	
	466,00 MHz		—	2,5	4,5	dB	
Lower sidelobe	430,00 ... 452,00 MHz		36,0	45,0	—	dB	
Upper sidelobe	507,00 ... 530,00 MHz		34,0	44,0	—	dB	
Reflected wave signal suppression							
0,13 μ s ... 2,0 μ s after main pulse			40,0	49,0	—	dB	
Amplitude							
Amplitude ripple (p-p)	471,00 ... 488,00 MHz	$\Delta\alpha$	—	0,3	0,6	dB	
Group delay							
Group delay ripple (p-p)	466,00 ... 493,00 MHz	$\Delta\tau$	—	11	18	ns	
Impedance at 479,50 MHz							
Input: $Z_{IN} = R_{IN} \parallel C_{IN}$			—	170 \parallel 3,6	—	$\Omega \parallel$ pF	
Output: $Z_{OUT} = R_{OUT} \parallel C_{OUT}$			—	180 \parallel 3,8	—	$\Omega \parallel$ pF	
Temperature coefficient of frequency			TC_f	—	-86	—	ppm/K

B 611
479,50 MHz

Frequency response

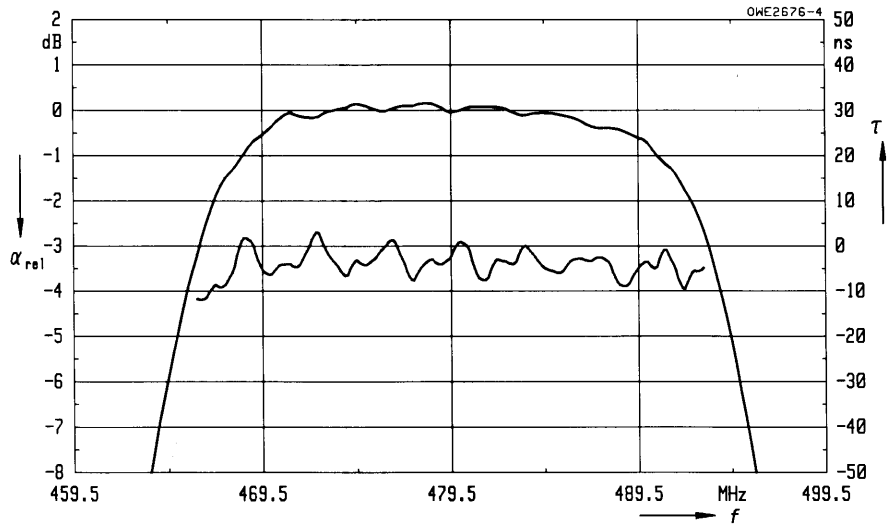
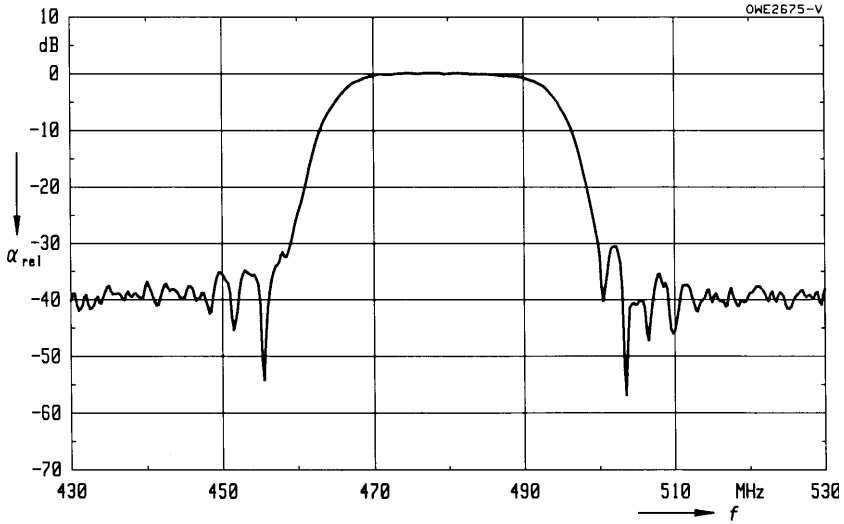

Characteristics of channel 2

Ambient temperature $T_A = 25\text{ °C}$
 Source impedance $Z_S = 50\ \Omega$
 Load impedance $Z_L = 50\ \Omega$
 Group delay aperture 0,25 MHz

			min.	typ.	max.	
Insertion attenuation	479,50 MHz	α	—	20,4	22,1	dB
Reference level for the following data						
Center frequency		f_c	478,50	479,50	480,50	MHz
Pass bandwidth ($\alpha_{rel} \leq 3\text{ dB}$)		B_{3dB}	—	18,00	—	MHz
Relative attenuation		α_{rel}				
	470,50 MHz		—	3,5	4,5	dB
	488,50 MHz		—	2,3	4,5	dB
Lower sidelobe	430,00 ... 457,50 MHz		36,0	44,0	—	dB
Upper sidelobe	500,50 ... 530,00 MHz		34,0	42,0	—	dB
Reflected wave signal suppression						
0,13 μ s ... 2,0 μ s after main pulse			40,0	44,0	—	dB
Amplitude						
Amplitude ripple (p-p) 476,00 ... 483,00 MHz $\Delta\alpha$			—	0,3	0,6	dB
Group delay		τ				
Group delay ripple (p-p) 470,50 ... 488,50 MHz $\Delta\tau$			—	11	18	ns
Impedance at 479,50 MHz						
Output: $Z_{OUT} = R_{OUT} \parallel C_{OUT}$			—	130 \parallel 3,3	—	$\Omega \parallel$ pF
Temperature coefficient of frequency		TC_f	—	- 86	—	ppm/K

Frequency response

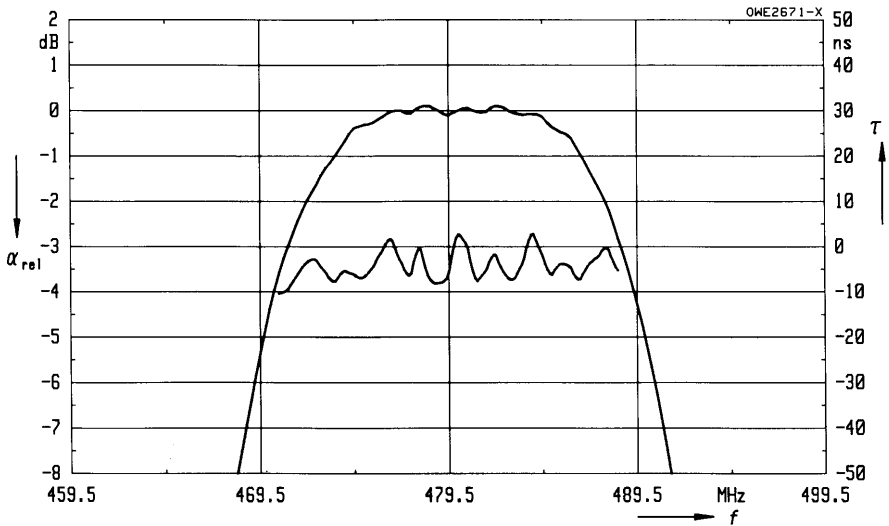
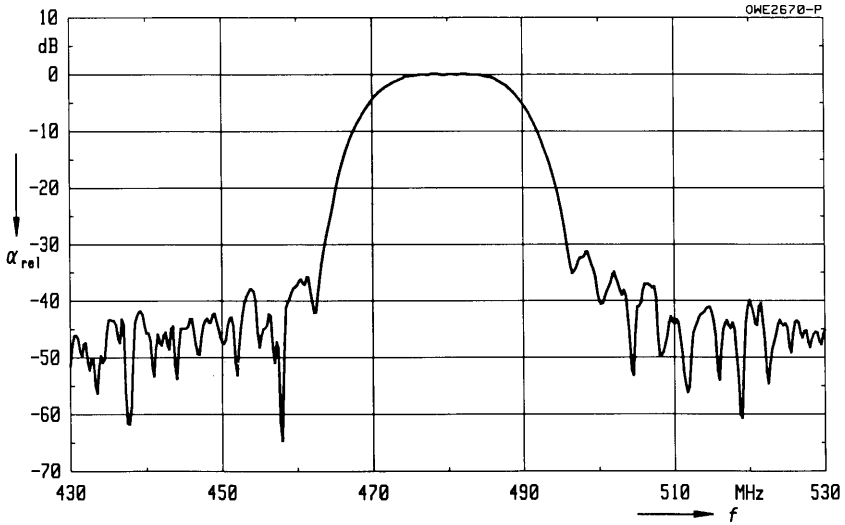

Features

- Two-channel satellite receiver filter
- IF filter for DSB receivers
- Constant group delay
- Improved ESD capability by integrated shunt resistors

Terminals

- Gold-plated NiFeCo alloy

Metal package TO 39

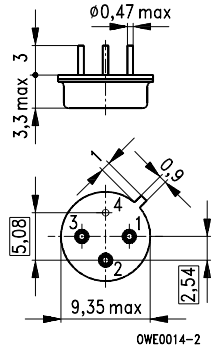

Dimensions in mm, approx. weight 1,0 g

Pin configuration

- 1 Input
- 2 Output – channel 2
- 3 Output – channel 1
- 4 Ground

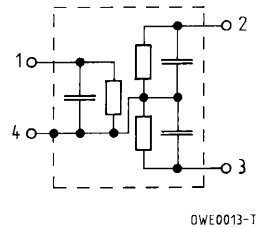

Type	Ordering code	Marking
B 635	B39481-B635-B210	Type, date code

Electrostatic Sensitive Device (ESD)

Maximum ratings

Ambient temperature	T_A	- 20/+ 80	°C	—
Storage temperature	T_{stg}	- 25/+ 85	°C	—
DC voltage	V_{DC}	0	V	between any terminals
AC voltage	V_{pp}	5	V	between any terminals

B 635

480,00 MHz

Characteristics of channel 1

Ambient temperature	$T_A = 25\text{ °C}$
Source impedance	$Z_S = 50\ \Omega$
Load impedance	$Z_L = 50\ \Omega$
Group delay aperture	0,25 MHz

				min.	typ.	max.	
Insertion attenuation	480,00 MHz	α	—	23,2	25,0	dB	
Reference level for the following data							
Center frequency		f_c	479,00	480,00	481,00	MHz	
Pass bandwidth ($\alpha_{rel} \leq 3\text{ dB}$)		B_{3dB}	—	33,50	—	MHz	
Relative attenuation		α_{rel}	—	2,2	—	dB	
	463,50 MHz		—	3,0	—	dB	
Lower sidelobe	430,00 ... 455,00 MHz		36,0	42,5	—	dB	
Upper sidelobe	505,00 ... 530,00 MHz		36,0	43,5	—	dB	
Reflected wave signal suppression			40,0	45,0	—	dB	
0,135 μs ... 2,0 μs after main pulse							
Amplitude			—	0,2	0,6	dB	
Amplitude ripple (p-p)	470,50 ... 489,50 MHz	$\Delta\alpha$					
Group delay	480,00 MHz	τ	—	300	—	ns	
Group delay ripple (p-p)	464,00 ... 496,00 MHz	$\Delta\tau$	—	9	18	ns	
Impedance at 480,00 MHz			—	60 5,3	—	Ω pF	
	Input: $Z_{IN} = R_{IN} \parallel C_{IN}$		—	230 3,8	—	Ω pF	
	Output: $Z_{OUT} = R_{OUT} \parallel C_{OUT}$						
DC resistance			—	250	—	Ω	
	Input: R_{IN}		—	500	—	Ω	
	Output: R_{OUT}						
Temperature coefficient of frequency		TC_f	—	- 86	—	ppm/K	

Frequency response

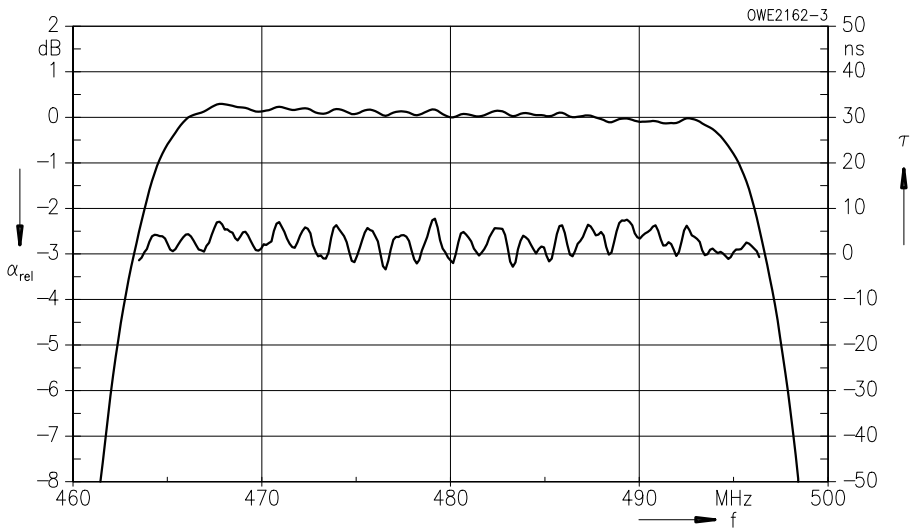
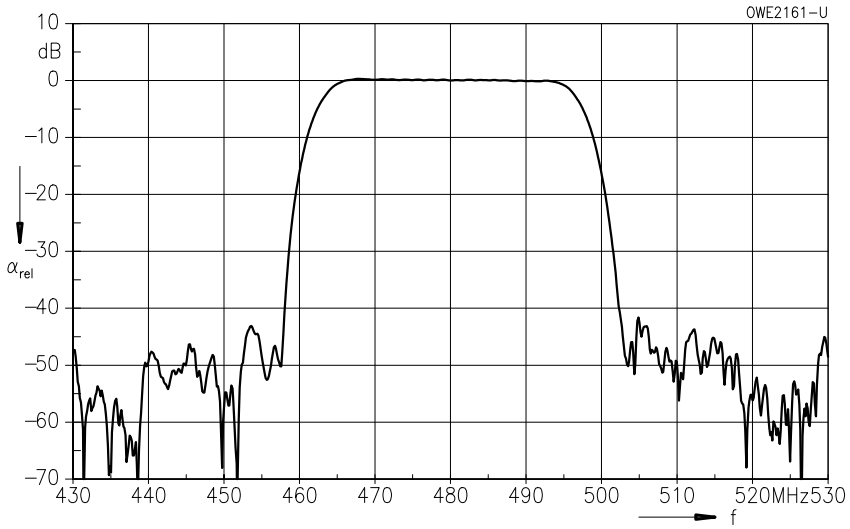

B 635

480,00 MHz

Characteristics of channel 2

Ambient temperature	$T_A = 25\text{ °C}$
Source impedance	$Z_S = 50\ \Omega$
Load impedance	$Z_L = 50\ \Omega$
Group delay aperture	0,25 MHz

			min.	typ.	max.	
Insertion attenuation	480,00 MHz	α	—	22,2	25,0	dB
Reference level for the following data						
Center frequency		f_c	479,00	480,00	481,00	MHz
Pass bandwidth ($\alpha_{rel} \leq 3\text{ dB}$)		B_{3dB}	—	36,10	—	MHz
Relative attenuation		α_{rel}				
	462,00 MHz		—	2,7	—	dB
	498,00 MHz		—	3,1	—	dB
Lower sidelobe	430,00 ... 453,50 MHz		36,0	47,0	—	dB
Upper sidelobe	506,50 ... 530,00 MHz		36,0	45,0	—	dB
Reflected wave signal suppression						
0,13 μ s ... 2,0 μ s after main pulse			40,0	45,0	—	dB
Amplitude						
Amplitude ripple (p-p) 469,00 ... 491,00 MHz $\Delta\alpha$			—	0,4	0,7	dB
Group delay	480,00 MHz	τ	—	300	—	ns
Group delay ripple (p-p) 462,50 ... 497,50 MHz $\Delta\tau$			—	10	18	ns
Impedance at 480,00 MHz						
Input: $Z_{IN} = R_{IN} \parallel C_{IN}$			—	60 \parallel 5,3	—	$\Omega \parallel$ pF
Output: $Z_{OUT} = R_{OUT} \parallel C_{OUT}$			—	220 \parallel 4,3	—	$\Omega \parallel$ pF
DC Resistance						
Input: R_{IN}			—	250	—	Ω
Output: R_{OUT}			—	500	—	Ω
Temperature coefficient of frequency		TC_f	—	- 86	—	ppm/K

Frequency response

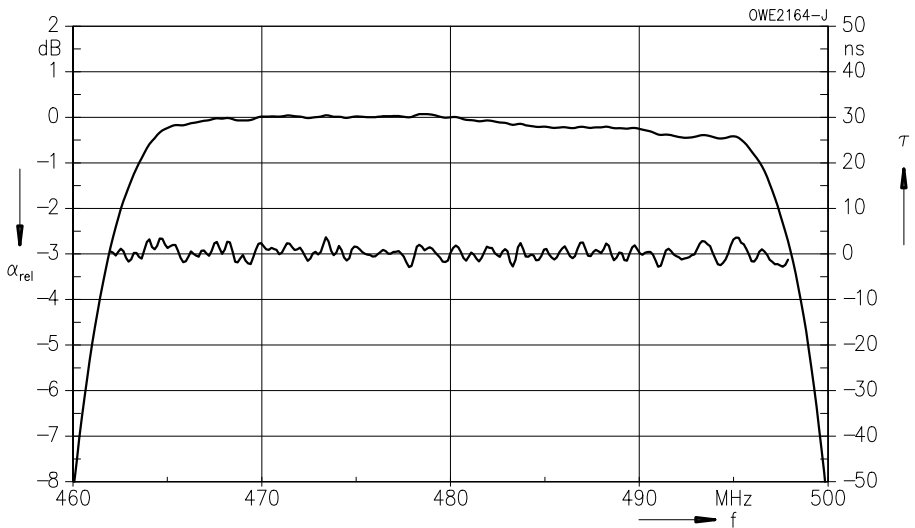
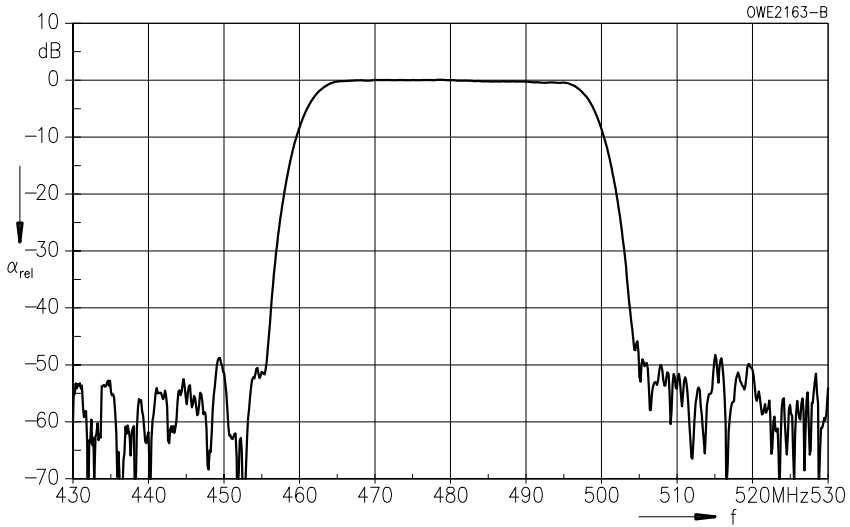

Features

- IF filter for DSB receivers
- Constant group delay
- Optimized group delay time
- Improved ESD capability by integrated shunt resistors

Terminals

- Gold-plated NiFeCo alloy

Metal package TO 39

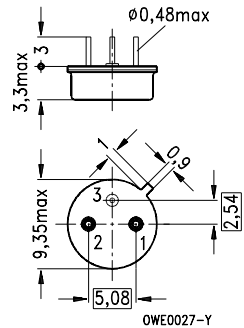

Dimensions in mm, approx. weight 1,0 g

Pin configuration

- 1 Input
- 2 Output
- 3 Ground

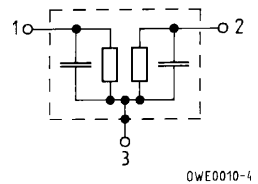

Type	Ordering code	Marking
B 692	B39481-B692-B510	Type, date code

Electrostatic Sensitive Device (ESD)

Maximum ratings

Ambient temperature	T_A	- 20/+ 80	°C	—
Storage temperature	T_{stg}	- 25/+ 85	°C	—
DC voltage	V_{DC}	0	V	between any terminals
AC voltage	V_{pp}	5	V	between any terminals

Characteristics

Ambient temperature	$T_A = 25\text{ °C}$
Source impedance	$Z_S = 50\ \Omega$
Load impedance	$Z_L = 50\ \Omega$
Group delay aperture	0,25 MHz

			min.	typ.	max.	
Insertion attenuation	480,00 MHz	α	—	20,0	21,5	dB
Reference level for the following data						
Center frequency		f_c	479,00	480,00	481,00	MHz
Pass bandwidth ($\alpha_{rel} \leq 3\text{ dB}$)		B_{3dB}	25,60	26,60	27,60	MHz
Relative attenuation		α_{rel}				
	466,50 MHz		—	3,0	4,6	dB
	493,50 MHz		—	3,2	4,6	dB
Lower sidelobe	430,00 ... 455,50 MHz		40,0	46,3	—	dB
Upper sidelobe	504,50 ... 530,00 MHz		38,0	42,0	—	dB
Reflected wave signal suppression						
	0,11 μ s ... 2,0 μ s after main pulse		40,0	47,0	—	dB
Amplitude						
Amplitude ripple (p-p)	473,50 ... 486,50 MHz	$\Delta\alpha$	—	0,3	0,5	dB
Group delay						
	480,00 MHz	τ	—	250	—	ns
Group delay ripple (p-p)	467,00 ... 493,00 MHz	$\Delta\tau$	—	9	15	ns
Impedance at 480,00 MHz						
	Input: $Z_{IN} = R_{IN} \parallel C_{IN}$		—	60 \parallel 4,8	—	$\Omega \parallel$ pF
	Output: $Z_{OUT} = R_{OUT} \parallel C_{OUT}$		—	260 \parallel 3,1	—	$\Omega \parallel$ pF
DC resistance						
	Input: R_{IN}		—	500	—	Ω
	Output: R_{OUT}		—	500	—	Ω
Temperature coefficient of frequency						
		TC_f	—	- 86	—	ppm/K

Frequency response

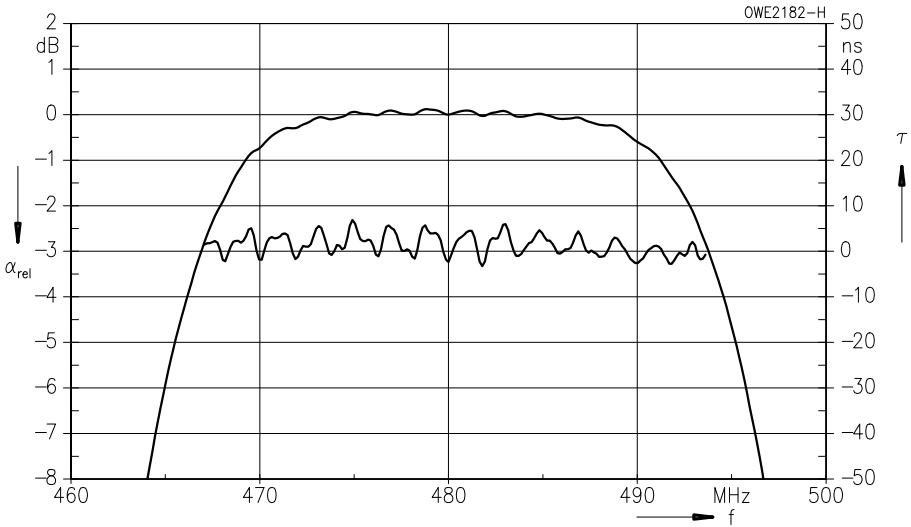
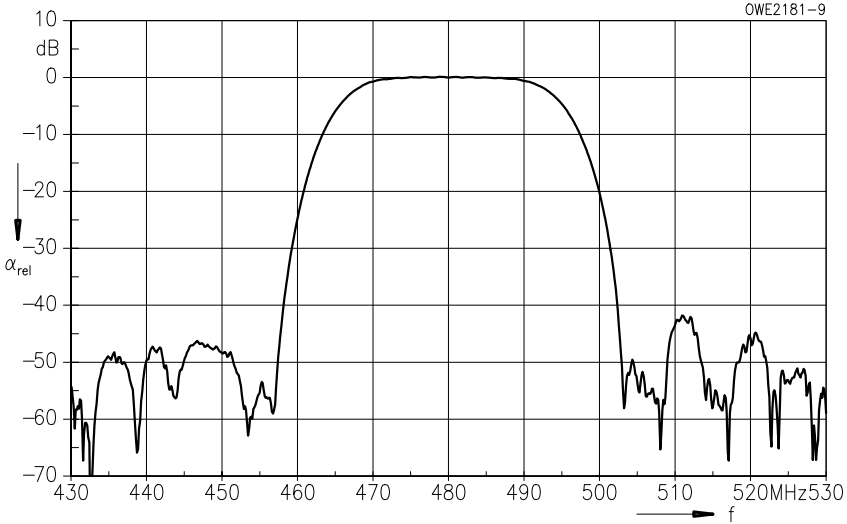

Features

- IF filter for DSB receivers
- Constant group delay
- Optimized group delay time
- Improved ESD capability by integrated shunt resistors

Terminals

- Gold-plated NiFeCo alloy

Metal package TO 39

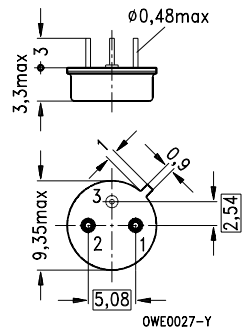

Dimensions in mm, approx. weight 1,0 g

Pin configuration

- 1 Input
- 2 Output
- 3 Ground

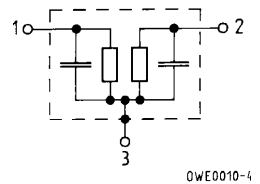

Type	Ordering code	Marking
B 694	B39481-B694-B510	Type, date code

Electrostatic Sensitive Device (ESD)

Maximum ratings

Ambient temperature	T_A	- 20/+ 80	°C	—
Storage temperature	T_{stg}	- 25/+ 85	°C	—
DC voltage	V_{DC}	0	V	between any terminals
AC voltage	V_{pp}	5	V	between any terminals

B 694

480,00 MHz

Characteristics

Ambient temperature	$T_A = 25\text{ °C}$
Source impedance	$Z_S = 50\ \Omega$
Load impedance	$Z_L = 50\ \Omega$
Group delay aperture	0,25 MHz

			min.	typ.	max.	
Insertion attenuation	480,00 MHz	α	—	19,5	21,0	dB
Reference level for the following data						
Center frequency		f_c	479,00	480,00	481,00	MHz
Pass bandwidth ($\alpha_{rel} \leq 3\text{ dB}$)		B_{3dB}	16,60	17,60	18,60	MHz
Relative attenuation		α_{rel}				
	471,00 MHz		—	3,4	5,4	dB
	489,00 MHz		—	3,0	5,4	dB
Lower sidelobe	430,00 ... 461,00 MHz		38,0	50,0	—	dB
Upper sidelobe	499,00 ... 530,00 MHz		38,0	45,0	—	dB
Reflected wave signal suppression						
0,13 μs ... 2,0 μs after main pulse			40,0	46,0	—	dB
Amplitude						
Amplitude ripple (p-p) 476,00 ... 484,00 MHz $\Delta\alpha$			—	0,3	0,6	dB
Group delay	480,00 MHz	τ	—	281	—	ns
Group delay ripple (p-p) 471,50 ... 488,50 MHz $\Delta\tau$			—	12	18	ns
Impedance at 480,00 MHz						
Input: $Z_{IN} = R_{IN} \parallel C_{IN}$			—	70 \parallel 3,7	—	$\Omega \parallel \text{pF}$
Output: $Z_{OUT} = R_{OUT} \parallel C_{OUT}$			—	280 \parallel 2,5	—	$\Omega \parallel \text{pF}$
DC resistance						
Input: R_{IN}			—	500	—	Ω
Output: R_{OUT}			—	500	—	Ω
Temperature coefficient of frequency		TC_f	—	- 86	—	ppm/K

Frequency response

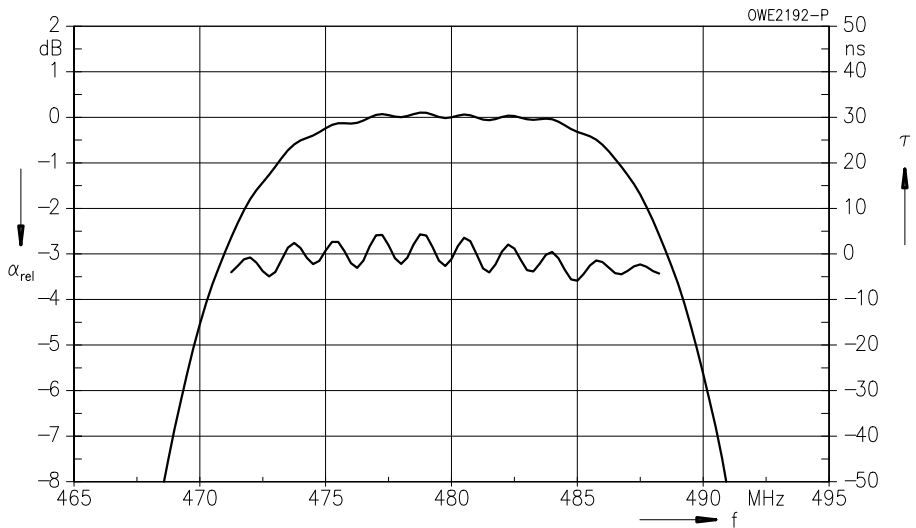
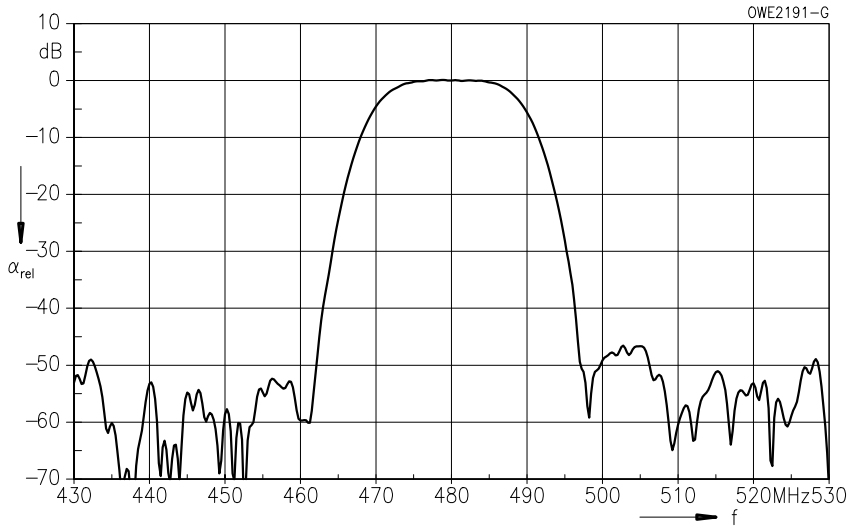



Siemens Matsushita Components

Ceramic chip capacitors from stock

Small in size, big in performance

Our selection of capacitors ranges from standard sizes down to a miniature highlight in 0402 style. Measuring only 1 x 0.5 x 0.5 mm, it's an ideal solution for applications where space is tight, like in handies and cardiac pacemakers. At the same time all our chips can boast excellent soldering characteristics, with special terminal variants for conductive adhesion. And we also thought about the right packing for automatic placement. You get all sizes down to 1206 in bulk case for example, plus voltage ratings from 16 to 500 V. By the way, our leaded models have CECC approval of course, in fact they were certified more than ten years ago.

More in the new short form catalog!



SCS - dependable, fast and competent

Vestigial Sideband Filters

Survey

Picture carrier MHz	Vestigial sideband MHz	Sound	Standard ¹⁾	Package	Type	Page ²⁾
32,70	0,7	no	L	DIP 24-06	B 540	#
38,00	0,75	yes	D/K	DIP 24-06	B 542	#
	0,75	yes	D/K	SIP 6 M	B 587	#
38,90	0,75	yes	B/G	DIP 24-03	B 522	#
	0,75	no	B/G	DIP 24-03	B 523	274
	0,75	yes	B/G	DIP 16	B 530	277
	0,75	no	B/G	DIP 16	B 531	#
	0,75	yes	B/G	DIP 24-06	B 534	#
	0,75	no	B/G	DIP 24-06	B 537	280
	1,25	no	I	DIP 24-06	B 541	#
	0,75	no	D/K	DIP 24-06	B 543	#
	1,00	NICAM	I	DIP 24-06	B 576	#
	0,75	yes	B/G	SIP 6 M	B 585	283
	1,25	yes	I	SIP 6 M	B 586	#
	0,75	yes	B/G	SIP 6 M	B 588	#
	0,75	yes	B/G	SIP 5 K	G 4960 M	286
	0,75	yes	D/K	SIP 5 K	K 4960 M	#
45,75	0,75	no	M/N	DIP 24-06	B 545	289
	0,75	yes	M/N	SIP 5 K	M 4950 M	#

1) For explanation of standards see individual data sheets or index on page [349](#)

2) Filters marked by the sign # are only listed in the survey. Detailed information on these types upon request.

Standard

- B/G
Germany, Europe

Features

- Vestigial sideband filter with sound suppression
- Constant group delay
- Hermetically sealed metal package

Terminals

- Gold-plated NiFeCo alloy

Metal package DIP 24-03

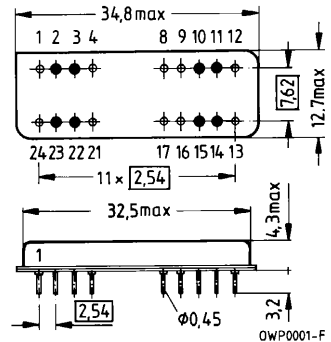

Dimensions in mm, approx. weight 6,4 g

Pin configuration

- | | |
|--------------------|-----------------|
| 3 | Input |
| 2 | Input – ground |
| 15 | Output |
| 14 | Output – ground |
| 1, 4, 8, 9, 12, | |
| 13, 16, 17, 21, 24 | Case – ground |
| 10, 11, 22, 23 | Not connected |

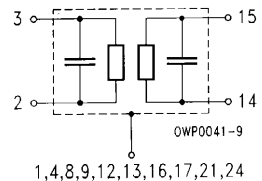

Type	Ordering code	Marking
B 523	B39380-B523-G410	Type, date code, pin 1

Electrostatic Sensitive Device (ESD)

Maximum ratings

Ambient temperature	T_A	- 25/+ 85	°C	—
Storage temperature	T_{stg}	- 40/+ 85	°C	—
DC voltage	V_{DC}	0	V	—
Source power	P_s	15	dBm	source impedance 50 Ω

Characteristics

Ambient temperature	$T_A = 25\text{ °C}$
Source impedance	$Z_S = 50\ \Omega$
Load impedance	$Z_L = 50\ \Omega$
Group delay aperture	120 kHz

		min.	typ.	max.	
Nominal frequency	f_N	—	38,90	—	MHz
Insertion attenuation at f_N	α_N	28,0	30,0	32,0	dB
Relative attenuation (relative to α_N)	α_{rel}				
33,40 MHz		38,0	40,0	—	dB
34,00 MHz		− 0,5	0,8	1,5	dB
34,10 MHz		− 0,5	0,2	0,6	dB
39,65 MHz		1,0	1,5	2,0	dB
25,00 ... 32,00 MHz		45,0	53,0	—	dB
32,00 ... 32,65 MHz		40,0	48,0	—	dB
32,65 ... 33,30 MHz		38,0	41,0	—	dB
40,15 ... 41,20 MHz		38,0	41,0	—	dB
41,20 ... 45,00 MHz		44,0	48,0	—	dB
Amplitude ripple (p-p)	$\Delta\alpha$				
34,30 ... 39,00 MHz		—	0,3	0,5	dB
34,20 ... 39,40 MHz		—	0,6	1,0	dB
Reflected wave signal suppression					
2,5 μ s ... 12,0 μ s after main pulse		50,0	55,0	—	dB
Group delay at f_N	τ_N	—	3,6	—	μ s
Group delay ripple (p-p)	$\Delta\tau$				
33,80 ... 39,60 MHz		—	40	50	ns
Temperature coefficient of frequency	TC_f	—	− 87	—	ppm/K

Frequency response

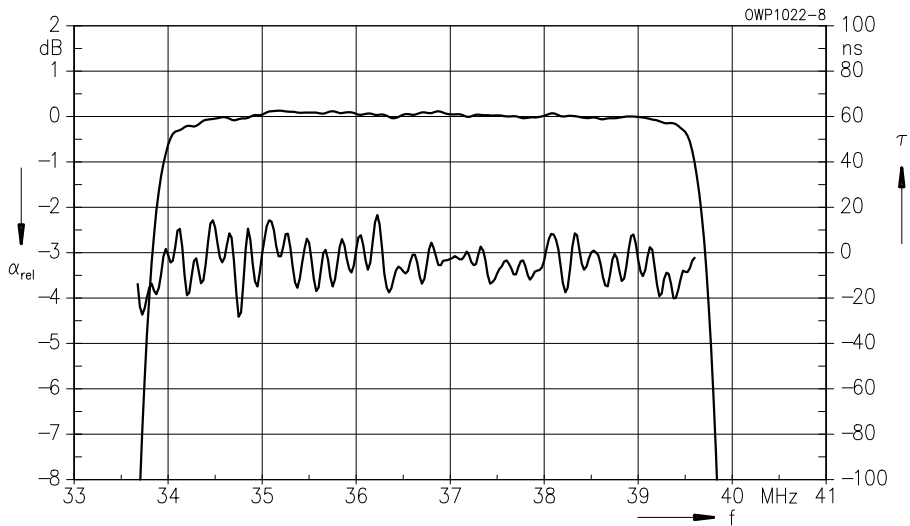
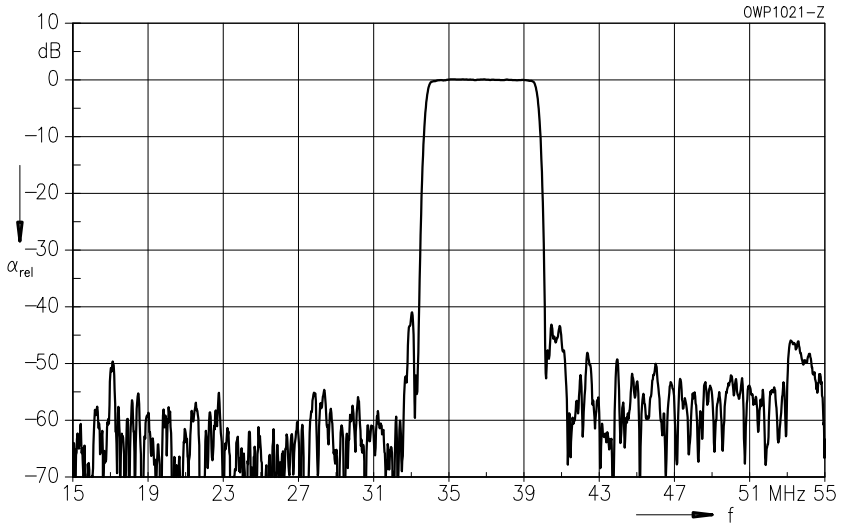

Standard

- B/G
Germany, Europe

Features

- Vestigial sideband filter with sound
- Constant group delay
- Hermetically sealed metal package

Terminals

- Gold-plated NiFeCo alloy

Metal package DIP 16

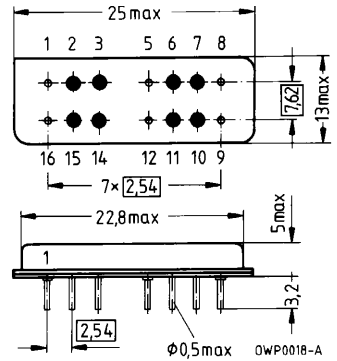

Dimensions in mm, approx. weight 4,2 g

Pin configuration

- | | |
|--------------------|-----------------|
| 3 | Input |
| 2 | Input – ground |
| 11 | Output |
| 10 | Output – ground |
| 1, 5, 8, 9, 12, 16 | Case – ground |
| 6, 7, 14, 15 | Not connected |

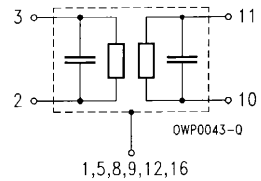

Type	Ordering code	Marking
B 530	B39390-B530-E110	Type, date code, pin 1

Electrostatic Sensitive Device (ESD)

Maximum ratings

Ambient temperature	T_A	- 25/+ 85	°C	—
Storage temperature	T_{stg}	- 40/+ 85	°C	—
DC voltage	V_{DC}	0	V	—
Source power	P_s	15	dBm	source impedance 50 Ω

B 530

38,90 MHz

Characteristics

Ambient temperature	$T_A = 50\text{ °C}$
Source impedance	$Z_S = 50\ \Omega$
Load impedance	$Z_L = 50\ \Omega$
Group delay aperture	80 kHz

		min.	typ.	max.	
Nominal frequency	f_N	—	38,90	—	MHz
Insertion attenuation at f_N	α_N	29,0	30,0	31,0	dB
Relative attenuation (relative to α_N)	α_{rel}				
31,90 MHz		38,0	43,0	—	dB
33,40 MHz		- 0,1	0,1	0,4	dB
39,65 MHz		0,5	1,3	2,5	dB
40,15 MHz		15,0	20,0	—	dB
40,40 MHz		32,0	36,0	—	dB
20,00 ... 31,00 MHz		45,0	50,0	—	dB
31,00 ... 31,90 MHz		38,0	45,0	—	dB
40,40 ... 41,90 MHz		32,0	36,0	—	dB
41,90 ... 50,00 MHz		40,0	44,0	—	dB
Amplitude ripple (p-p)	$\Delta\alpha$				
34,30 ... 39,00 MHz		—	0,2	0,4	dB
Reflected wave signal suppression					
2,7 μs ... 12,0 μs after main pulse		50,0	60,0	—	dB
Group delay at f_N	τ_N	—	2,2	—	μs
Group delay ripple (p-p)	$\Delta\tau$				
34,30 ... 39,60 MHz		—	30	50	ns
Temperature coefficient of frequency	TC_f	—	- 87	—	ppm/K

Frequency response

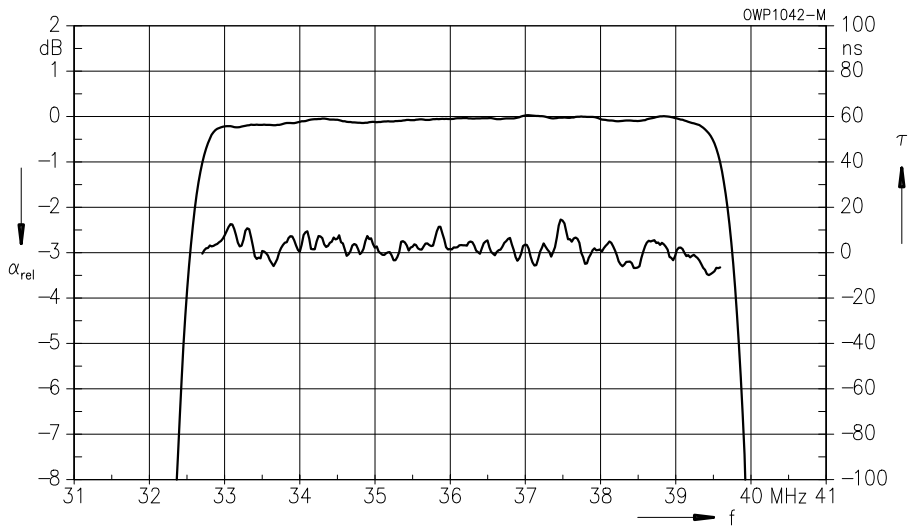
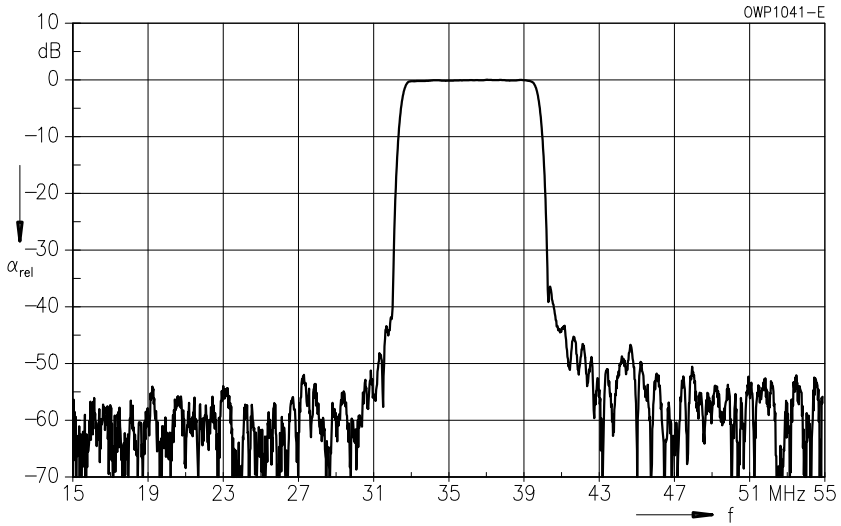

Standard

- B/G
Europe, Germany

Features

- Vestigial sideband filter with sound suppression
- Constant group delay
- Hermetically sealed metal package

Terminals

- Gold-plated NiFeCo alloy

Metal package DIP 24-06

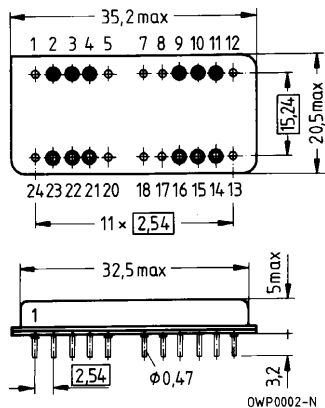

Dimensions in mm, approx. weight 10,4 g

Pin configuration

- | | |
|--------------------|-----------------|
| 3 | Input |
| 2 | Input – ground |
| 15 | Output |
| 14 | Output – ground |
| 1, 5, 7, 8, 12, | |
| 13, 17, 18, 20, 24 | Case – ground |
| 4, 9, 10, 11, | |
| 16, 21, 22, 23 | Not connected |

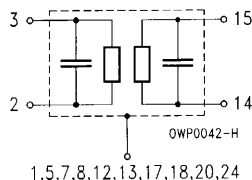

Type	Ordering code	Marking
B 537	B39390-B537-G310	Type, date code, pin 1

Electrostatic Sensitive Device (ESD)

Maximum ratings

Ambient temperature	T_A	- 25/+ 85	°C	—
Storage temperature	T_{stg}	- 40/+ 85	°C	—
DC voltage	V_{DC}	0	V	—
Source power	P_s	15	dBm	source impedance 50 Ω

Characteristics

Ambient temperature	$T_A = 60\text{ °C}$
Source impedance	$Z_S = 50\ \Omega$
Load impedance	$Z_L = 50\ \Omega$
Group delay aperture	80 kHz

		min.	typ.	max.	
Nominal frequency	f_N	—	38,90	—	MHz
Insertion attenuation at f_N	α_N	29,0	30,0	31,0	dB
Relative attenuation (relative to α_N)	α_{rel}				
33,80 MHz		—	2,1	5,0	dB
33,90 MHz		—	0,5	2,0	dB
39,65 MHz		—	0,8	2,0	dB
15,00 ... 31,90 MHz		48,0	52,0	—	dB
31,90 ... 33,40 MHz		45,0	48,0	—	dB
40,05 ... 40,15 MHz		25,0	45,0	—	dB
40,15 ... 40,65 MHz		45,0	51,0	—	dB
40,65 ... 55,00 MHz		48,0	53,0	—	dB
Amplitude ripple (p-p)	$\Delta\alpha$				
34,15 ... 39,50 MHz		—	0,2	0,4	dB
Reflected wave signal suppression					
3,5 μ s ... 13,0 μ s after main pulse		50,0	63,0	—	dB
Group delay at f_N	τ_N	—	4,4	—	μ s
Group delay ripple (p-p)	$\Delta\tau$				
33,90 ... 39,65 MHz		—	40	50	ns
Temperature coefficient of frequency	TC_f	—	- 87	—	ppm/K

Frequency response

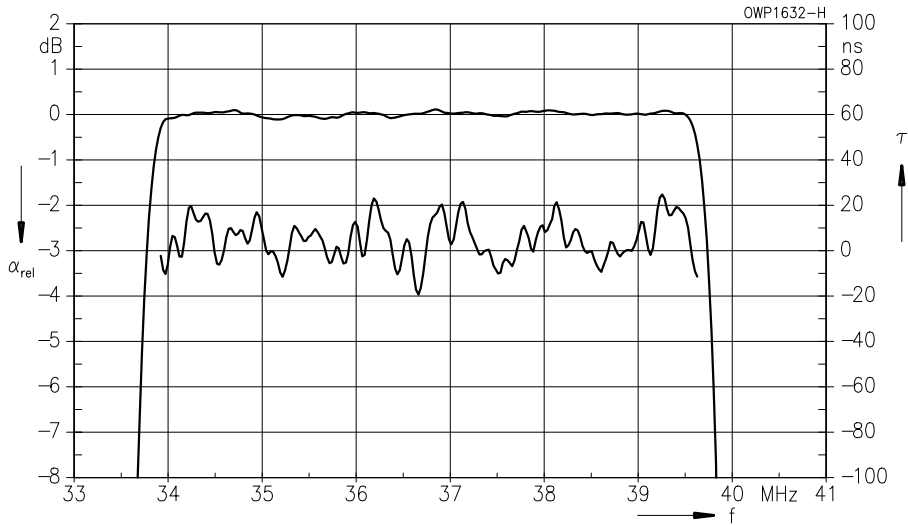
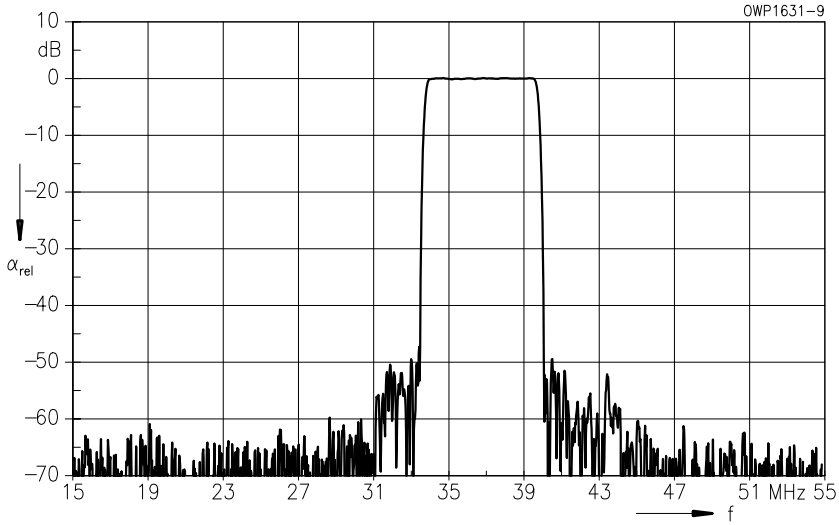

Standard

- B/G-CCIR
Germany, Europe partly

Metal package **SIP 6 M**

Features

- IF filter for antenna converters
- Full transmission of vestigial sideband and sound carrier
- Constant group delay
- Hermetically sealed metal package

Terminals

- Tinned NiFeCo alloy

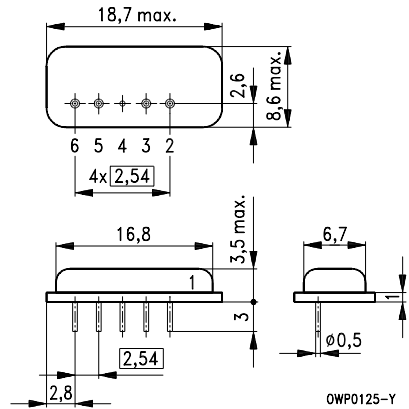

Dimensions in mm, approx. weight 3,0 g

Pin configuration

- 2 Input
- 3 Input – ground
- 6 Output
- 5 Output – ground
- 4 Case – ground

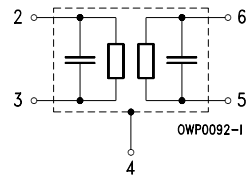

Type	Ordering code	Marking
B 585	B39390-B585-X110	Type, date code, pin 1

Electrostatic Sensitive Device (ESD)

Maximum ratings

Ambient temperature	T_A	- 25/+ 85	°C	—
Storage temperature	T_{stg}	- 40/+ 85	°C	—
DC voltage	V_{DC}	0	V	—
Source power	P_s	15	dBm	source impedance 50 Ω

B 585

38,90 MHz

Characteristics

Ambient temperature	$T_A = 25\text{ °C}$
Source impedance	$Z_S = 50\ \Omega$
Load impedance	$Z_L = 50\ \Omega$
Group delay aperture	80 kHz

		min.	typ.	max.	
Nominal frequency	f_N	—	38,90	—	MHz
Insertion attenuation at f_N	α_N	33,4	34,9	36,4	dB
Relative attenuation (relative to α_N)	α_{rel}				
	39,65 MHz	2,3	3,3	4,3	dB
Sound carrier	33,40 MHz	-0,8	0,2	1,2	dB
2nd sound carrier	33,15 MHz	-0,9	0,1	1,1	dB
Adjacent picture carrier	31,90 MHz	34,0	43,0	—	dB
	40,15 MHz	22,0	25,0	—	dB
Adjacent sound carrier	40,40 MHz	34,0	44,0	—	dB
	44,40 MHz	38,0	49,0	—	dB
Lower sidelobe	25,00 ... 31,90 MHz	32,0	38,0	—	dB
Upper sidelobe	40,40 ... 45,00 MHz	30,0	37,0	—	dB
Reflected wave signal suppression					
1,5 μ s ... 6,0 μ s after main pulse		42,0	52,0	—	dB
Feedthrough signal suppression					
1,6 μ s ... 1,5 μ s before main pulse		50,0	56,0	—	dB
Group delay ripple (p-p)	$\Delta\tau$				
	33,40 ... 39,65 MHz	—	55	80	ns
Impedance at f_N					
Input: $Z_{IN} = R_{IN} \parallel C_{IN}$		—	1,0 \parallel 22,2	—	k Ω \parallel pF
Output: $Z_{OUT} = R_{OUT} \parallel C_{OUT}$		—	2,9 \parallel 7,3	—	k Ω \parallel pF
Temperature coefficient of frequency	TC_f	—	-94	—	ppm/K

Frequency response

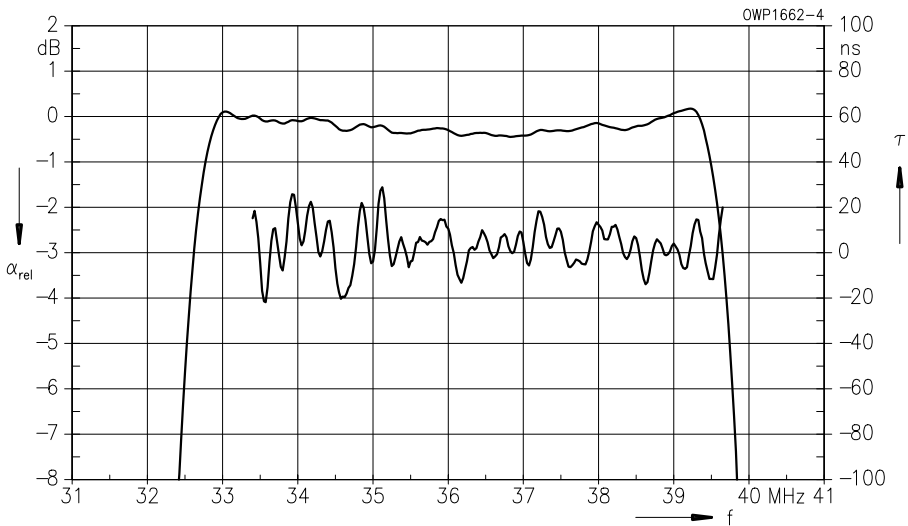
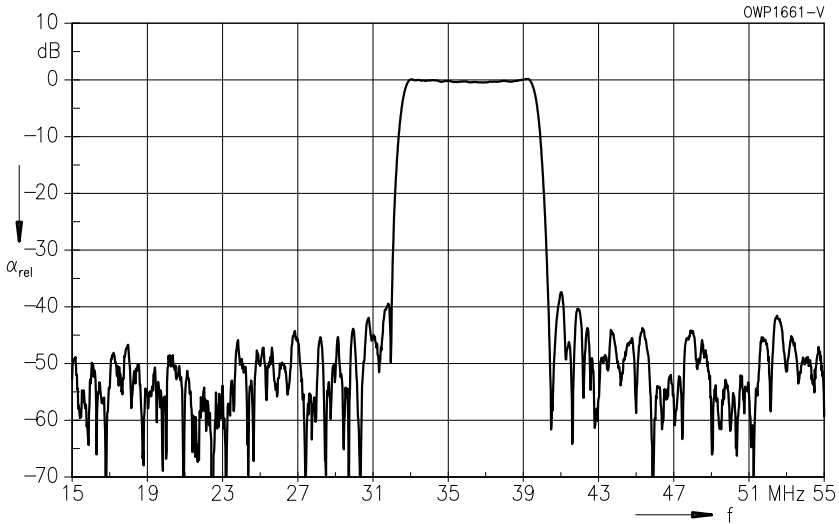

Standard

- B/G-CCIR
Germany, Europe partly

Features

- IF filter for antenna converters
- Full transmission of vestigial sideband and sound carrier
- Group delay predistortion for transmitters

Terminals

- Tinned CuFe alloy

Plastic package **SIP 5 K**

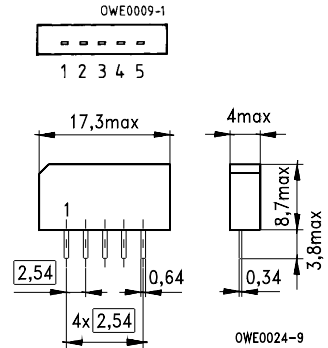

Dimensions in mm, approx. weight 1,0 g

Pin configuration

- 1 Input
- 2 Input – ground
- 3 Chip carrier – ground
- 4 Output
- 5 Output

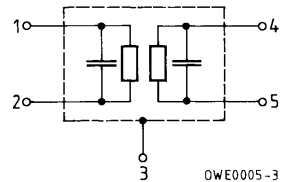

Type	Ordering code	Marking
G 4960 M	B39389-G4960-M100	Type, date code, pin 1

Maximum ratings

Ambient temperature	T_A	- 25/+ 65	°C	—
Storage temperature	T_{stg}	- 25/+ 85	°C	—
DC voltage	V_{DC}	12	V	between any terminals
AC voltage	V_{pp}	10	V	between any terminals

Characteristics

Ambient temperature $T_A = 25\text{ °C}$
 Source impedance $Z_S = 50\ \Omega$
 Load impedance $Z_L = 2\text{ k}\Omega \parallel 3\text{ pF}$

		min.	typ.	max.	
Insertion attenuation					
Reference level for the following data	38,90 MHz	18,4	19,9	21,4	dB
Relative attenuation					
	39,65 MHz	2,7	3,9	5,1	dB
Sound carrier	33,40 MHz	- 1,2	- 0,2	0,8	dB
2nd sound carrier	33,15 MHz	- 1,4	- 0,4	0,6	dB
Adjacent picture carrier	31,90 MHz	34,0	49,0	—	dB
Adjacent sound carrier	40,40 MHz	32,0	42,0	—	dB
	44,40 MHz	40,0	49,0	—	dB
Lower sidelobe	25,00 ... 31,90 MHz	32,0	42,0	—	dB
Upper sidelobe	40,40 ... 45,00 MHz	32,0	38,0	—	dB
Reflected wave signal suppression					
1,3 μ s ... 6,0 μ s after main pulse (test pulse: 250 ns, carrier frequency: 38,90 MHz)		42,0	52,0	—	dB
Feedthrough signal suppression					
1,4 μ s ... 1,3 μ s before main pulse (test pulse: 250 ns, carrier frequency: 38,90 MHz)		50,0	56,0	—	dB
Group delay predistortion					
(reference frequency 38,90 MHz)					
	36,90 MHz	—	95	—	ns
	34,47 MHz	—	- 100	—	ns
Impedance at 38,90 MHz					
Input:	$Z_{IN} = R_{IN} \parallel C_{IN}$	—	1,6 \parallel 15,2	—	k Ω \parallel pF
Output:	$Z_{OUT} = R_{OUT} \parallel C_{OUT}$	—	3,6 \parallel 3,6	—	k Ω \parallel pF
Temperature coefficient of frequency					
	TC_f	—	- 72	—	ppm/K

Frequency response

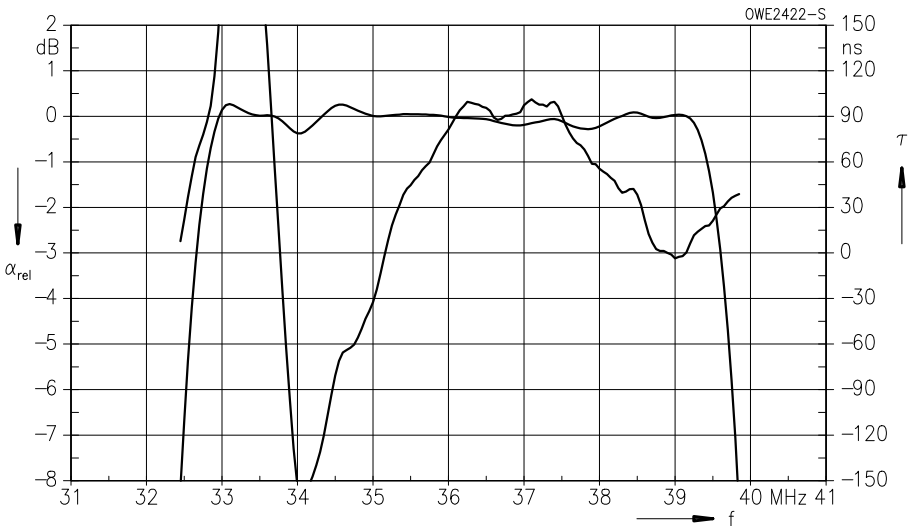
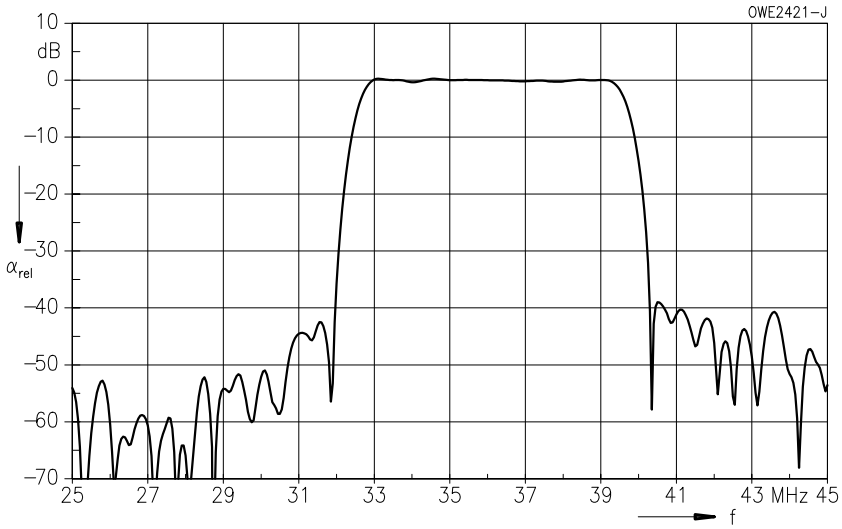

Standard

- M/N
USA, South America

Features

- Vestigial sideband filter with sound suppression
- Constant group delay
- Hermetically sealed metal package

Terminals

- Gold-plated NiFeCo alloy

Metal package DIP 24-06

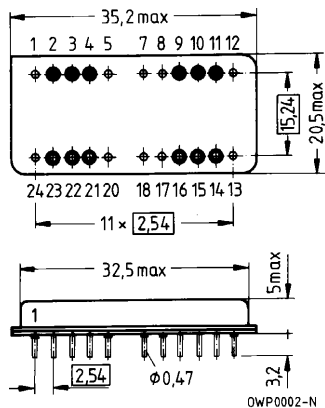

Dimensions in mm, approx. weight 10,4 g

Pin configuration

- | | |
|--------------------|-----------------|
| 3 | Input |
| 2 | Input – ground |
| 15 | Output |
| 14 | Output – ground |
| 1, 5, 7, 8, 12, | |
| 13, 17, 18, 20, 24 | Case – ground |
| 4, 9, 10, 11, | |
| 16, 21, 22, 23 | Not connected |

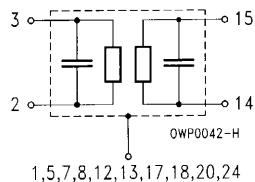

Type	Ordering code	Marking
B 545	B39460-B545-G310	Type, date code, pin 1

Electrostatic Sensitive Device (ESD)

Maximum ratings

Ambient temperature	T_A	- 25/+ 85	°C	—
Storage temperature	T_{stg}	- 40/+ 85	°C	—
DC voltage	V_{DC}	0	V	—
Source power	P_s	15	dBm	source impedance 50 Ω

B 545

45,75 MHz

Characteristics

Ambient temperature	$T_A = 60\text{ °C}$
Source impedance	$Z_S = 50\ \Omega$
Load impedance	$Z_L = 50\ \Omega$
Group delay aperture	80 kHz

		min.	typ.	max.	
Nominal frequency	f_N	—	45,75	—	MHz
Insertion attenuation at f_N	α_N	26,5	27,5	29,0	dB
Relative attenuation (relative to α_N)	α_{rel}				
41,65 MHz		—	1,4	2,0	dB
46,50 MHz		—	1,1	2,0	dB
20,00 ... 40,15 MHz		50,0	55,0	—	dB
40,15 ... 41,20 MHz		45,0	52,0	—	dB
47,00 ... 47,70 MHz		45,0	48,0	—	dB
47,70 ... 60,00 MHz		50,0	54,0	—	dB
Amplitude ripple (p-p)	$\Delta\alpha$				
41,85 ... 46,25 MHz		—	0,3	0,5	dB
Reflected wave signal suppression					
3,5 μ s ... 13,0 μ s after main pulse		50,0	63,0	—	dB
Group delay at f_N	τ_N	—	4,4	—	μ s
Group delay ripple (p-p)	$\Delta\tau$				
41,85 ... 46,25 MHz		—	30	50	ns
Temperature coefficient of frequency	TC_f	—	- 87	—	ppm/K

Frequency response

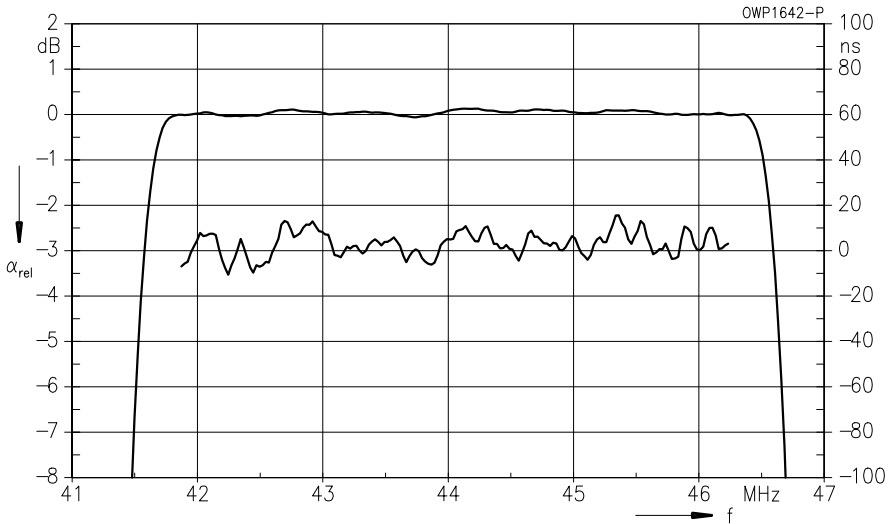
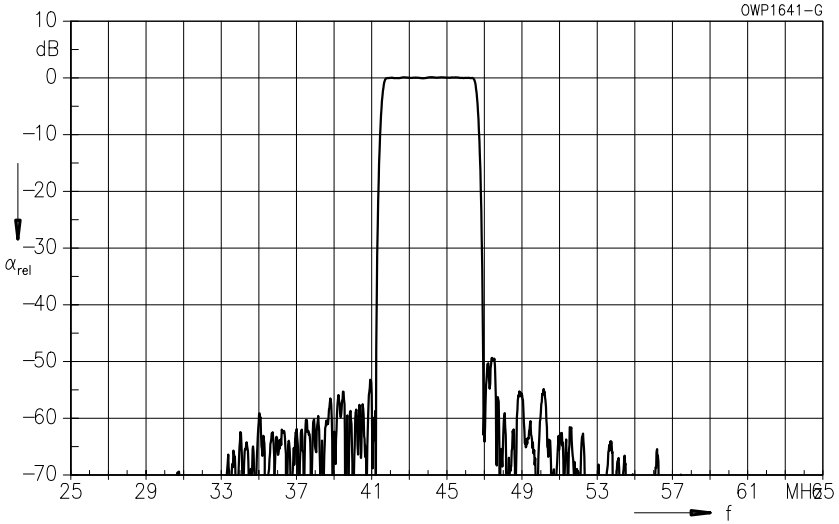



Siemens Matsushita Components

SAW resonators for radio remote control

Making a lot of things a lot easier

The key to convenience and security: radio remote controls for keyless entry in automobiles and opening the garage gate. Or in the household, for cordless headphones or metering heating costs for example. Here the evaporation pipe is replaced by a sensor that signals consumption by



a transmitter to a receiver outside the domicile, thus doing away with readings on all the radiators. Transmitter and receiver are both fitted with a SAW resonator.

SCS – dependable, fast and competent



Spectrum-Shaping Filters

Survey

f_c ¹⁾ MHz	f_Y MHz	a	p	k	α	α_{rel}	Package	Type	Page ²⁾
70,00	11,95	0,35	0,4	0,0	33	41	DIP 16	B 2540	#
	12,10	0,30	0,5	0,5	34	34	DIP 16	B 2559	#
	12,30	0,33	0,5	0,5	34	40	DIP 16	B 2565	#
	7,755	0,40	0,5	1,0	30	35	DIP 16	B 2569	294
	7,755	0,40	0,5	0,0	27	40	DIP 16	B 2570	297
	13,52	0,34	0,5	0,5	40	54	DIP 24-06	B 2573	#
122,50	13,52	0,32	0,5	0,5	31	50	DIP 16	B 2578	#
157,50	13,52	0,32	0,5	0,5	27	50	DIP 16	B 2579	300
140,00	13,82	0,45	0,5	0,0	27	50	DIP 16	B 2580	#

1) For explanation of symbols see individual data sheets or index on page [347](#)

2) Filters marked by the sign # are only listed in the survey. Detailed information on these types upon request.

Features

- Spectrum-shaping filter for digital radio systems
- High-performance passband
- Constant group delay
- Hermetically sealed metal package

Terminals

- Gold-plated NiFeCo alloy

Metal package DIP 16

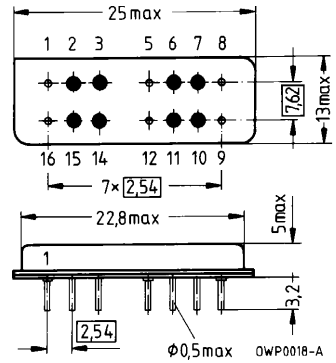

Dimensions in mm, approx. weight 4,2 g

Pin configuration

- | | |
|--------------------|-----------------|
| 3 | Input |
| 2 | Input – ground |
| 11 | Output |
| 10 | Output – ground |
| 1, 5, 8, 9, 12, 16 | Case – ground |
| 6, 7, 14, 15 | Not connected |

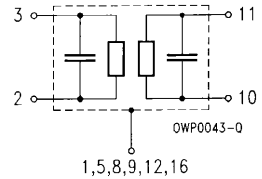

Type	Ordering code	Marking
B 2569	B39700-B2569-E110	Type, date code, pin 1

Electrostatic Sensitive Device (ESD)

Maximum ratings

Ambient temperature	T_A	- 25/+ 85	°C	—
Storage temperature	T_{stg}	- 40/+ 85	°C	—
DC voltage	V_{DC}	0	V	—
Source power	P_s	15	dBm	source impedance 50 Ω

Characteristics

Ambient temperature	$T_A = 25\text{ °C}$
Source impedance	$Z_S = 50\ \Omega$
Load impedance	$Z_L = 50\ \Omega$
Group delay aperture	1 MHz

		min.	typ.	max.	
Center frequency (center between 6 dB points)	f_c	69,85	70,0	70,15	MHz
Insertion attenuation at f_c	α_c	—	30,0	31,0	dB
Deviation from theoretical frequency response $\Delta\alpha$ $f_c \dots f_c \pm 0,8 \cdot f_Y$ $f_c \pm 0,8 \cdot f_Y \dots f_c \pm 1,1 \cdot f_Y$		—	$\pm 0,15$	$\pm 0,2$	dB
		—	$\pm 0,2$	$\pm 0,3$	dB
Relative attenuation (relative to α_c) 6,00 ... 58,00 MHz 58,00 ... 58,80 MHz 81,20 ... 86,50 MHz 86,50 ... 110,00 MHz	α_{rel}	40,0	45,0	—	dB
		35,0	40,0	—	dB
		30,0	35,0	—	dB
		35,0	40,0	—	dB
Reflected wave signal suppression 1,0 μ s ... 2,7 μ s after main pulse		50,0	55,0	—	dB
Group delay at f_c	τ_c	—	1,54	—	μ s
Group delay ripple (ρ -p) 62,00 ... 78,00 MHz	$\Delta\tau$	—	4	7	ns
		—	4	7	ns
Nyquist frequency	f_Y	—	7,755	—	MHz
Roll-off-factor	a	—	0,4	—	
Partitioning factor	ρ	—	0,5	—	MHz
sinx/x compensation factor	k	—	1,0	—	
Temperature coefficient of frequency	TC_f	—	- 87	—	ppm/K

Theoretical frequency response:

$$H(x) = (S(x))^{\rho} / (\text{sinc}(x \cdot \pi/2))^k$$

$$S(x) = \begin{cases} 1 & \text{for } |x| \leq 1 - a \\ (1 + \cos(\pi \cdot (|x| - 1 + a)/2a))/2 & \text{for } 1 - a < |x| < 1 + a \\ 0 & \text{for } |x| \geq 1 + a \end{cases}$$

$$x = (f - f_c)/f_Y$$

Frequency response

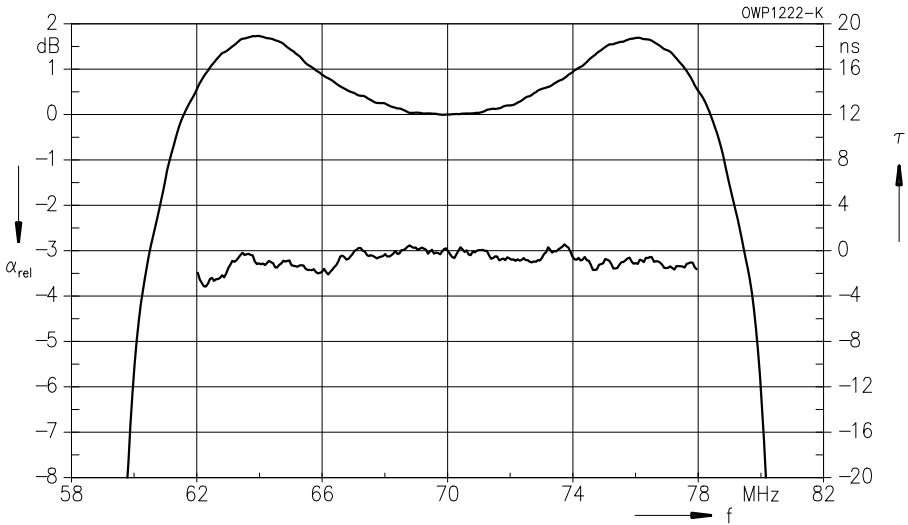
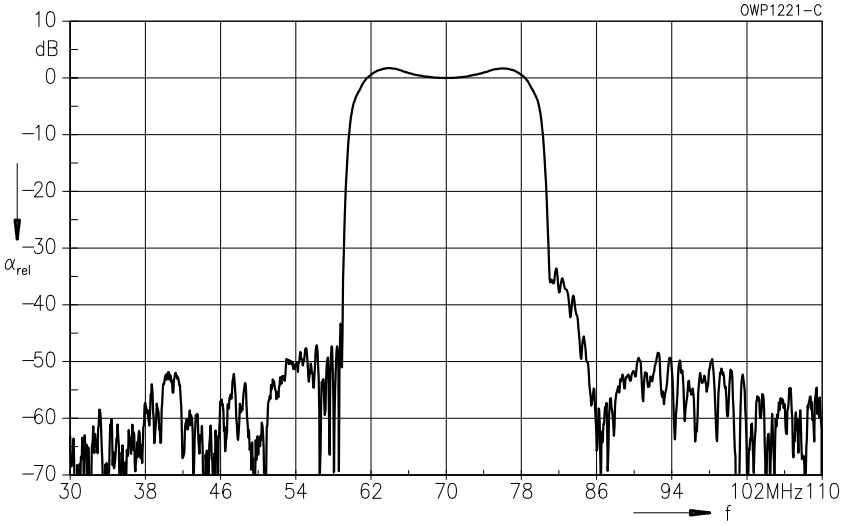

Features

- Spectrum-shaping filter for digital radio systems
- High-performance passband
- Constant group delay
- Hermetically sealed metal package

Terminals

- Gold-plated NiFeCo alloy

Metal package DIP 16

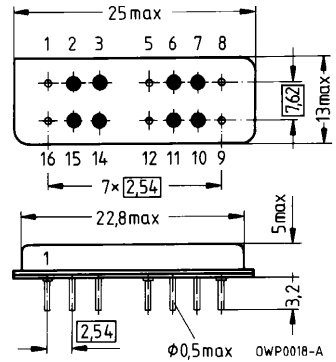

Dimensions in mm, approx. weight 4,2 g

Pin configuration

- | | |
|--------------------|-----------------|
| 3 | Input |
| 2 | Input – ground |
| 11 | Output |
| 10 | Output – ground |
| 1, 5, 8, 9, 12, 16 | Case – ground |
| 6, 7, 14, 15 | Not connected |

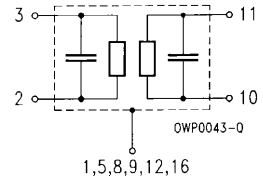

Type	Ordering code	Marking
B 2570	B39700-B2570-E110	Type, date code, pin 1

Electrostatic Sensitive Device (ESD)

Maximum ratings

Ambient temperature	T_A	- 25/+ 85	°C	—
Storage temperature	T_{stg}	- 40/+ 85	°C	—
DC voltage	V_{DC}	0	V	—
Source power	P_s	15	dBm	source impedance 50 Ω

B 2570

70,00 MHz

Characteristics

Ambient temperature	$T_A = 25\text{ °C}$
Source impedance	$Z_S = 50\ \Omega$
Load impedance	$Z_L = 50\ \Omega$
Group delay aperture	1 MHz

		min.	typ.	max.	
Center frequency (center between 6 dB points)	f_c	69,85	70,0	70,15	MHz
Insertion attenuation at f_c	α_c	—	27,0	29,0	dB
Deviation from theoretical frequency response $\Delta\alpha$ $f_c \dots f_c \pm 1,05 \cdot f_Y$ $f_c \pm 1,05 \cdot f_Y \dots f_c \pm 1,1 \cdot f_Y$		—	$\pm 0,1$	$\pm 0,2$	dB
		—	$\pm 0,15$	$\pm 0,3$	dB
Relative attenuation (relative to α_c) 6,00 ... 58,80 MHz 81,20 ... 88,00 MHz 88,00 ... 110,00 MHz	α_{rel}	40,0	45,0	—	dB
		35,0	40,0	—	dB
		40,0	45,0	—	dB
Reflected wave signal suppression 0,9 μ s ... 4,5 μ s after main pulse		50,0	55,0	—	dB
Group delay at f_c	τ_c	—	1,45	—	μ s
Group delay ripple (p-p) 62,00 ... 78,00 MHz	$\Delta\tau$	—	3	6	ns
Nyquist frequency	f_Y	—	7,755	—	MHz
Roll-off-factor	a	—	0,4	—	
Partitioning factor	ρ	—	0,5	—	
Temperature coefficient of frequency	TC_f	—	- 87	—	ppm/K

Theoretical frequency response:

$$H(x) = (S(x))^p$$

$$S(x) = \begin{cases} 1 & \text{for } |x| \leq 1 - a \\ (1 + \cos(\pi \cdot (|x| - 1 + a)/2a))/2 & \text{for } 1 - a < |x| < 1 + a \\ 0 & \text{for } |x| \geq 1 + a \end{cases}$$

$$x = (f - f_c)/f_Y$$

Frequency response

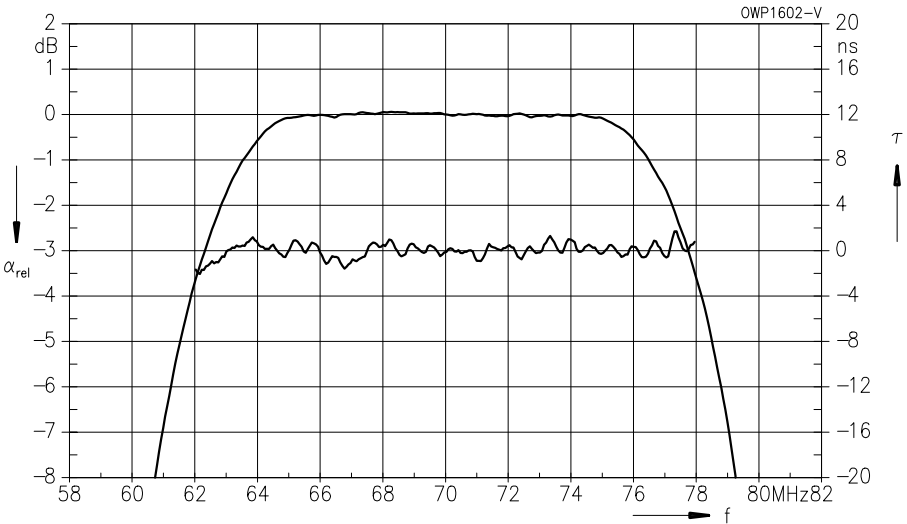
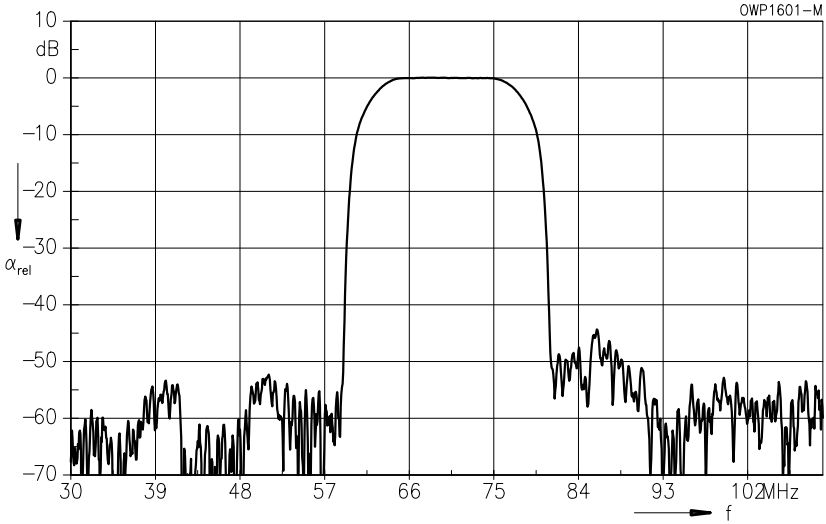

Features

- Spectrum-shaping filter for digital radio systems
- High-performance passband
- Constant group delay
- Hermetically sealed metal package

Terminals

- Gold-plated NiFeCo alloy

Metal package DIP 16

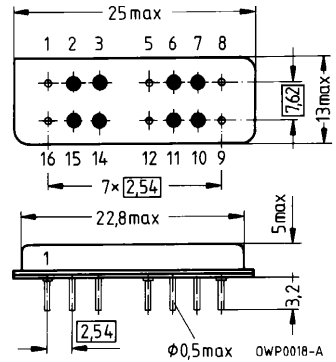

Dimensions in mm, approx. weight 4,2 g

Pin configuration

- | | |
|--------------------|-----------------|
| 3 | Input |
| 2 | Input – ground |
| 11 | Output |
| 10 | Output – ground |
| 1, 5, 8, 9, 12, 16 | Case – ground |
| 6, 7, 14, 15 | Not connected |

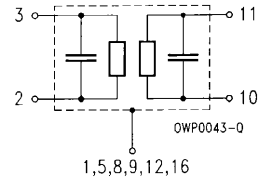

Type	Ordering code	Marking
B 2579	B39161-B2579-E110	Type, date code, pin 1

Electrostatic Sensitive Device (ESD)

Maximum ratings

Ambient temperature	T_A	- 25/+ 85	°C	—
Storage temperature	T_{stg}	- 40/+ 85	°C	—
DC voltage	V_{DC}	0	V	—
Source power	P_s	15	dBm	source impedance 50 Ω

Characteristics

Ambient temperature $T_A = 45\text{ °C}$
 Source impedance $Z_S = 50\ \Omega$
 Load impedance $Z_L = 50\ \Omega$

		min.	typ.	max.	
Center frequency (center between 6 dB points)	f_c	157,30	157,50	157,70	MHz
Insertion attenuation at f_c	α_c	25,8	26,8	27,8	dB
Deviation from theoretical frequency response (tilt removed)	$\Delta\alpha$				
	$f_c \dots f_c \pm f_Y$	—	$\pm 0,1$	$\pm 0,2$	dB
Pass band tilt		—	0,02	—	dB/MHz
Deviation from linear phase	$\Delta\phi$				
	$f_c \dots f_c \pm f_Y$	—	$\pm 0,75$	$\pm 1,0$	°
Relative attenuation (relative to α_c)	α_{rel}				
	85,00 ... 138,00 MHz	43,0	50,0	—	dB
	177,00 ... 215,00 MHz	41,0	50,0	—	dB
Reflected wave signal suppression 0,8 μ s ... 4,8 μ s after main pulse		50,0	55,0	—	dB
Group delay at f_c	τ_c	—	1,23	—	μ s
Nyquist frequency	f_Y	—	13,52	—	MHz
Roll-off-factor	a	—	0,32	—	
Partitioning factor	ρ	—	0,5	—	
sinx/x compensation factor	k	—	0,5	—	
Temperature coefficient of frequency	TC_f	—	- 87	—	ppm/K

Theoretical frequency response:

$$H(x) = (S(x))^{\rho} / (\text{sinc}(x \cdot \pi/2))^k$$

$$S(x) = \begin{cases} 1 & \text{for } |x| \leq 1 - a \\ (1 + \cos(\pi \cdot (|x| - 1 + a)/2a))/2 & \text{for } 1 - a < |x| < 1 + a \\ 0 & \text{for } |x| \geq 1 + a \end{cases}$$

$$x = (f - f_c)/f_Y$$

B 2579
157,50 MHz

Frequency response

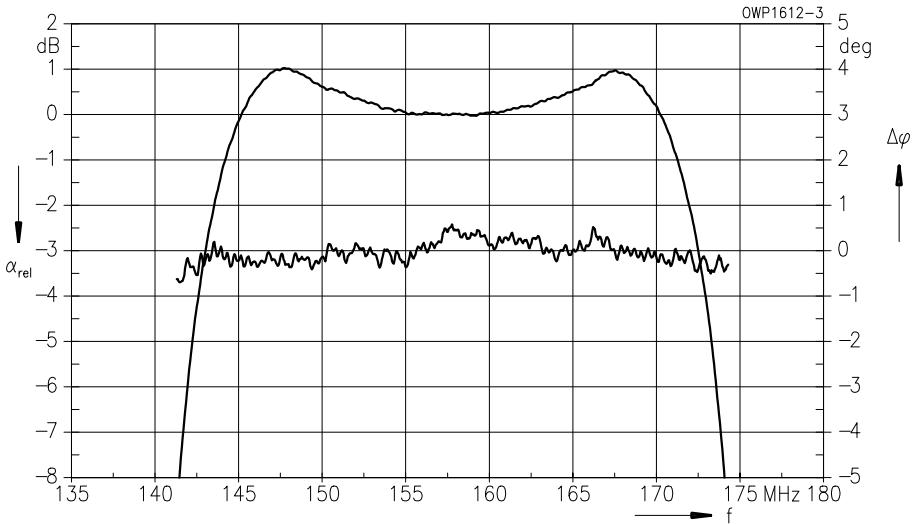
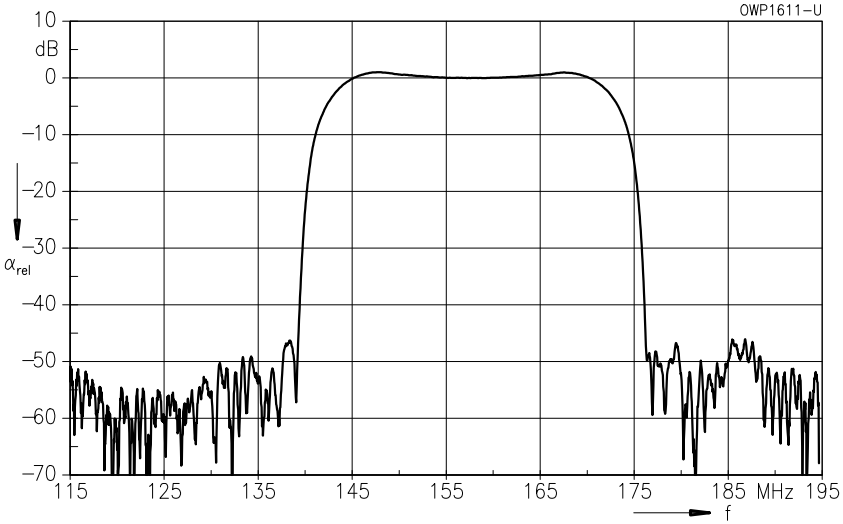

Bandpass Filters

Survey

f_c ¹⁾ MHz	B_{3dB} MHz	B_{40dB} MHz	α_{rel} (min.) dB	Standard ²⁾	Package	Type	Page ³⁾
36,00	1,35	2,25 ⁴⁾	30	DAB	SIP 6 M	B 589	#
36,20	2,7	4,0 ⁴⁾	32	DCR	SIP 5 K	X 6967 M	#
38,912	1,25	2,1 ⁴⁾	28	DAB	SIP 6 M	B 512	304
44,00	1,7	2,9 ⁴⁾	34	Interactive TV	SIP 5 K	X 6959 M	307
45,00	0,27	0,81	50	GSM	DIP 24-03	B 1507	#
60,00	20,1	24,1 ⁴⁾	33	DSS	SIP 5 K	X 6956 M	310
70,00	1,62	3,79	38	—	DIP 16	B 504	313
	11,3	7,5	43	—	DIP 16	B 519	#
	2,5	4,0	42	—	DIP 16	B 590	#
118,00	11,9	15,55	45	—	DIP 16	B 521	316
140,00	2,6	7,0	42	—	DIP 16	B 1529	#
287,35	1,07	2,6 ⁴⁾	39	—	DIP 16	B 1505	319
439,85	1,9	4,1	40	—	TO 8	B 558	322

1) For explanation of symbols see individual data sheets or index on page [347](#)

2) For explanation of standards see individual data sheets or index on page [349](#)

3) Filters marked by the sign # are only listed in the survey. Detailed information on these types upon request.

4) 30 dB bandwidth

Standard

- DAB
Digital audio broadcasting

Metal package SIP 6 M

Features

- Bandpass filter for DAB applications
- Constant group delay
- Hermetically sealed metal package

Terminals

- Tinned NiFeCo alloy

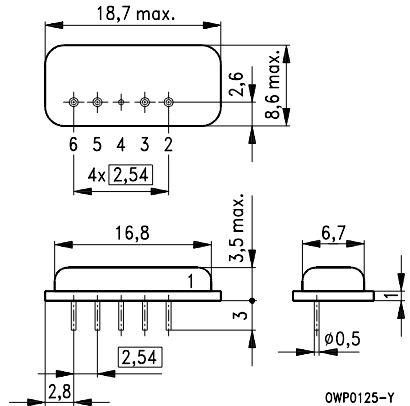

Dimensions in mm, approx. weight 3,0 g

Pin configuration

- 2 Input
- 3 Input – ground
- 5 Output
- 6 Output
- 4 Case – ground

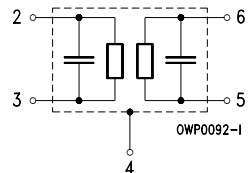

Type	Ordering code	Marking
B 512	B39390-B512-X110	Type, date code, pin 1

Electrostatic Sensitive Device (ESD)

Maximum ratings

Ambient temperature	T_A	- 25/+ 85	°C	—
Storage temperature	T_{stg}	- 40/+ 85	°C	—
DC voltage	V_{DC}	0	V	—
Source power	P_s	15	dBm	source impedance 50 Ω

Characteristics

Ambient temperature $T_A = 25\text{ °C}$
 Source impedance $Z_S = 50\ \Omega$ and matching network
 Load impedance $Z_L = 50\ \Omega$ and matching network
 Group delay aperture 80 kHz

		min.	typ.	max.	
Nominal frequency	f_N	—	38,912	—	MHz
Insertion attenuation at f_N	α_N	—	22,00	—	dB
Pass bandwidth					
$\alpha_{rel} \leq 3\text{ dB}$	$B_{3\text{dB}}$	1,15	1,25	1,35	MHz
$\alpha_{rel} \leq 10\text{ dB}$	$B_{10\text{dB}}$	—	1,60	1,75	MHz
$\alpha_{rel} \leq 20\text{ dB}$	$B_{20\text{dB}}$	—	1,90	2,05	MHz
$\alpha_{rel} \leq 30\text{ dB}$	$B_{30\text{dB}}$	—	2,10	—	MHz
Relative attenuation (relative to α_N)					
Lower sidelobe	30,00 ... 37,40 MHz	α_{rel} 38,00	41,00	—	dB
Upper sidelobe	40,40 ... 42,40 MHz	28,00	31,00	—	dB
	42,40 ... 50,00 MHz	34,00	37,00	—	dB
Reflected wave signal suppression					
	2,0 μs ... 6,0 μs after main pulse	40,0	45,0	—	dB
Group delay at f_N	τ_N	—	1,75	—	μs
Group delay ripple (p-p)	38,30 ... 39,50 MHz $\Delta\tau$	—	25	—	ns
Temperature coefficient of frequency	TC_f	—	-0,035	—	ppm/K ²

Matching network:

Input: Serial coil; L 1 = 3,3 μH , Q = 30

Output: Serial coil; L 2 = 6,8 μH , Q = 30

B 512
38,912 MHz

Frequency response

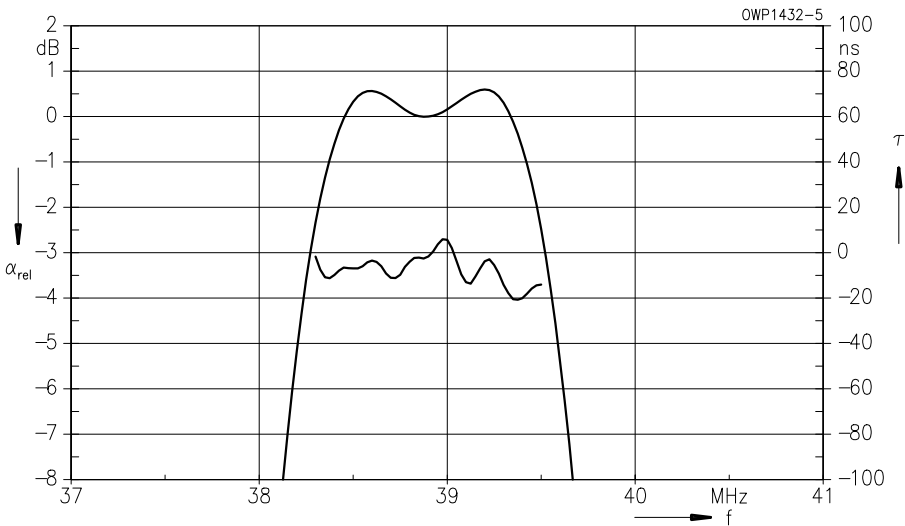
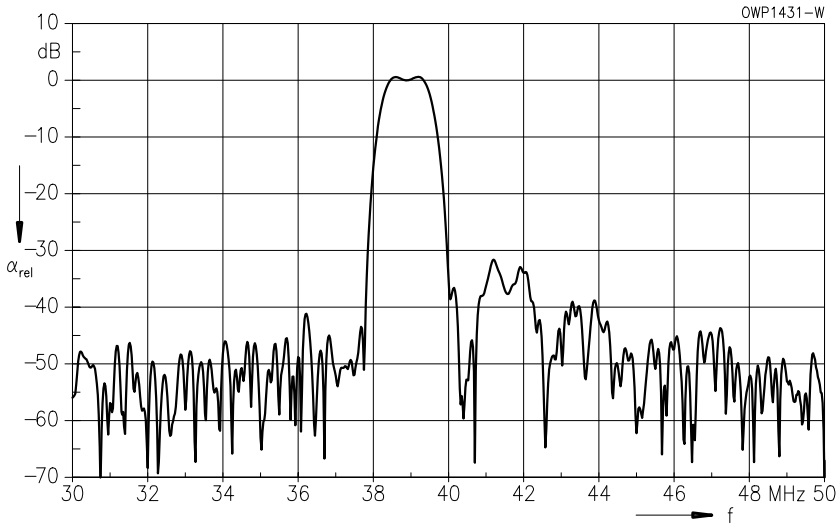

Standard

- Interactive TV

Features

- IF filter for Interactive TV applications
- Low group delay ripple

Terminals

- Tinned CuFe alloy

Plastic package **SIP 5 K**

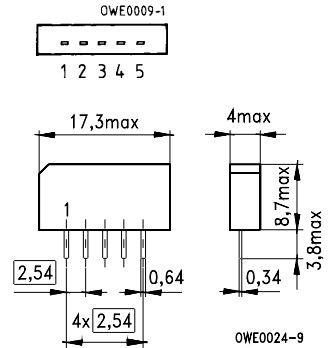

Dimensions in mm, approx. weight 1,0 g

Pin configuration

- 1 Input
- 2 Input – ground
- 3 Chip carrier – ground
- 4 Output
- 5 Output

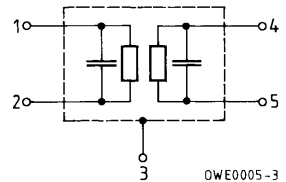

Type	Ordering code	Marking
X 6959 M	B39440-X6959-M100	Type, date code, pin 1

Maximum ratings

Ambient temperature	T_A	- 25/+ 65	°C	—
Storage temperature	T_{stg}	- 25/+ 85	°C	—
DC voltage	V_{DC}	12	V	between any terminals
AC voltage	V_{pp}	10	V	between any terminals

X 6959 M

44,00 MHz

Characteristics

Ambient temperature	$T_A = 25\text{ °C}$
Source impedance	$Z_S = 50\ \Omega$
Load impedance	$Z_L = 2\text{ k}\Omega \parallel 3\text{ pF}$
Group delay aperture	50 kHz

		min.	typ.	max.	
Center frequency (center between 3 dB points)	f_c	—	44,00	—	MHz
Insertion attenuation Reference level for the following data	44,00 MHz α	13,5	15,0	16,5	dB
Pass bandwidth $\alpha_{\text{rel}} \leq 3\text{ dB}$	$B_{3\text{dB}}$	—	1,70	—	MHz
$\alpha_{\text{rel}} \leq 6\text{ dB}$	$B_{6\text{dB}}$	—	2,00	—	MHz
$\alpha_{\text{rel}} \leq 30\text{ dB}$	$B_{30\text{dB}}$	—	2,90	—	MHz
Relative attenuation	α_{rel}				
Lower sidelobe	35,00 ... 41,30 MHz	40,0	45,0	—	dB
	41,30 ... 42,30 MHz	36,0	41,0	—	dB
Upper sidelobe	45,80 ... 47,20 MHz	34,0	40,0	—	dB
	47,20 ... 55,00 MHz	40,0	46,0	—	dB
Group delay ripple (p-p)	$\Delta\tau$				
	43,00 ... 45,00 MHz	—	45	—	ns
Impedance at 44,00 MHz					
Input: $Z_{\text{IN}} = R_{\text{IN}} \parallel C_{\text{IN}}$		—	1,6 \parallel 12,0	—	k Ω \parallel pF
Output: $Z_{\text{OUT}} = R_{\text{OUT}} \parallel C_{\text{OUT}}$		—	0,8 \parallel 3,8	—	k Ω \parallel pF
Temperature coefficient of frequency	TC_f	—	-72	—	ppm/K

Frequency response

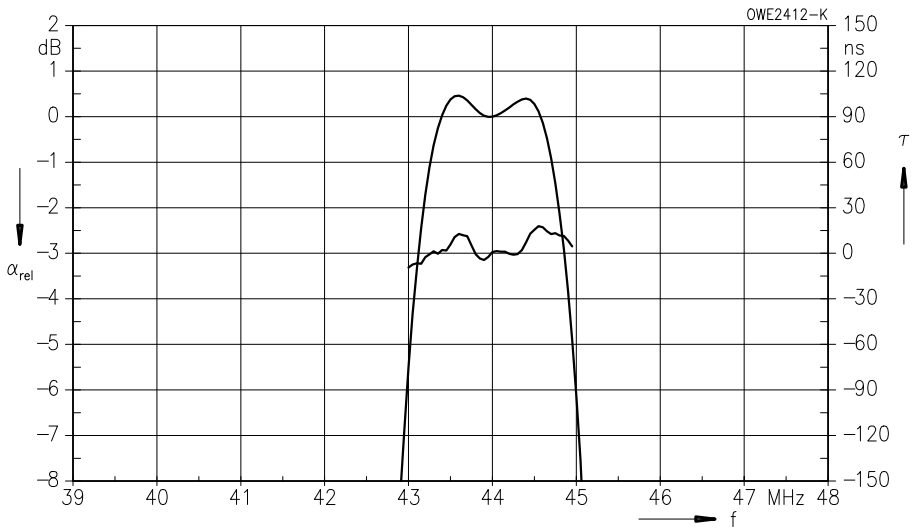
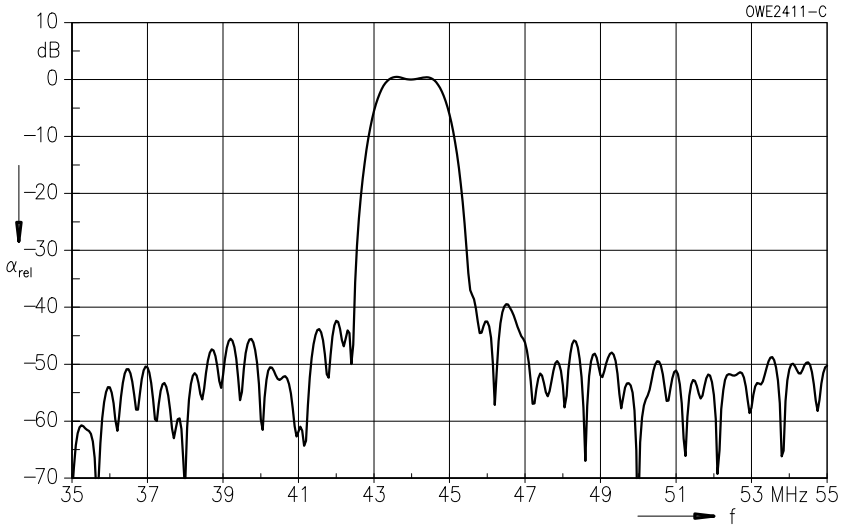

Standard

- DSS
Digital satellite system

Features

- IF filter for DSS receivers
- Constant group delay

Terminals

- Tinned CuFe alloy

Plastic package **SIP 5 K**

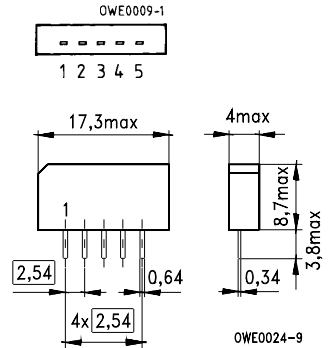

Dimensions in mm, approx. weight 1,0 g

Pin configuration

- 1 Input
- 2 Input – ground
- 3 Chip carrier – ground
- 4 Output
- 5 Output

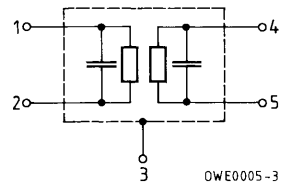

OWE0005-3

Type	Ordering code	Marking
X 6956 M	B39600-X6956-M100	Type, date code, pin 1

Maximum ratings

Ambient temperature	T_A	- 25/+ 65	°C	—
Storage temperature	T_{stg}	- 25/+ 85	°C	—
DC voltage	V_{DC}	12	V	between any terminals
AC voltage	V_{pp}	10	V	between any terminals

Characteristics

Ambient temperature	$T_A = 25\text{ °C}$
Source impedance	$Z_S = 50\ \Omega$
Load impedance	$Z_L = 2\text{ k}\Omega \parallel 3\text{ pF}$
Group delay aperture	3,6 MHz

		min.	typ.	max.	
Insertion attenuation	α				
Reference level for the following data	60,00 MHz	25,5	27,0	28,5	dB
Center frequency	f_c				
(center between 3 dB points)		59,88	60,00	60,12	MHz
Relative attenuation	α_{rel}				
Passband ripple	52,00 ... 68,00 MHz	—	0,35	0,70	dB
Lower sidelobe	40,00 ... 47,50 MHz	34,0	40,0	—	dB
Upper sidelobe	72,50 ... 80,00 MHz	33,0	40,0	—	dB
Pass bandwidth					
$\alpha_{rel} \leq 3\text{ dB}$	$B_{3\text{dB}}$	19,65	20,15	20,65	MHz
$\alpha_{rel} \leq 30\text{ dB}$	$B_{30\text{dB}}$	23,65	24,14	24,65	MHz
Stopband alpha		—	0,20	—	
Reflected wave signal suppression					
0,8 μs ... 6,0 μs after main pulse (test pulse: 250 ns, carrier frequency: 60,00 MHz)		44,0	56,0	—	dB
Feedthrough signal suppression					
1,1 μs ... 1,0 μs before main pulse (test pulse: 250 ns, carrier frequency: 60,00 MHz)		—	56,0	—	dB
Group delay ripple (p-p)	$\Delta\tau$				
51,50 ... 68,50 MHz		—	3	4	ns
Impedance at 60,00 MHz					
Input: $Z_{IN} = R_{IN} \parallel C_{IN}$		—	2,2 \parallel 12,0	—	k Ω \parallel pF
Output: $Z_{OUT} = R_{OUT} \parallel C_{OUT}$		—	2,2 \parallel 3,1	—	k Ω \parallel pF
Temperature coefficient of frequency	TC_f	—	- 72	—	ppm/K

Frequency response

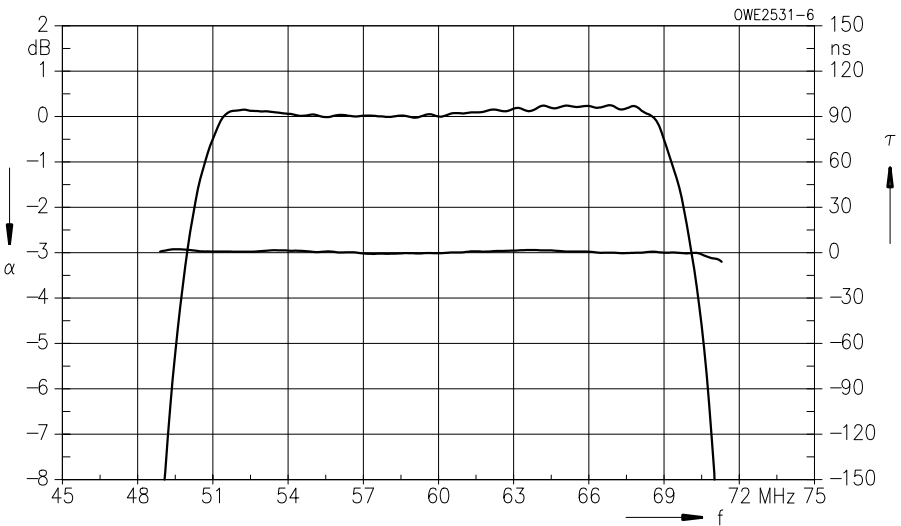
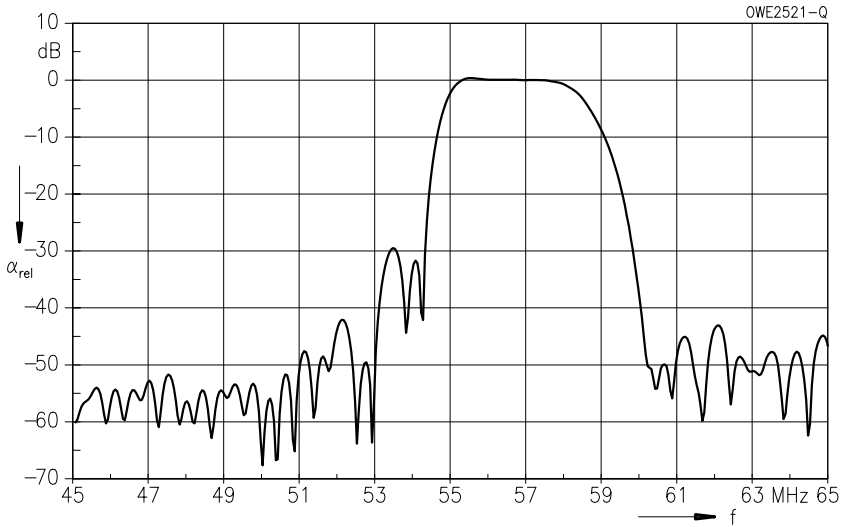

Features

- High-performance IF bandpass filter
- Constant group delay
- Hermetically sealed metal package

Terminals

- Gold-plated NiFeCo alloy

Metal package DIP 16

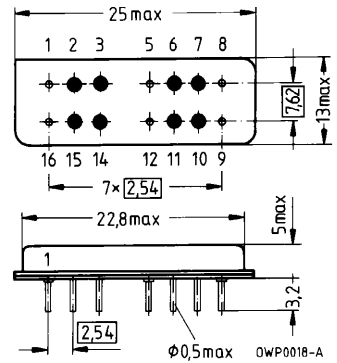

Dimensions in mm, approx. weight 4,2 g

Pin configuration

- | | |
|--------------------|-----------------|
| 3 | Input |
| 2 | Input – ground |
| 11 | Output |
| 10 | Output – ground |
| 1, 5, 8, 9, 12, 16 | Case – ground |
| 6, 7, 14, 15 | Not connected |

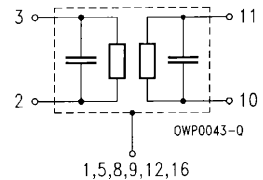

Type	Ordering code	Marking
B 504	B39700-B504-E110	Type, date code, pin 1

Electrostatic Sensitive Device (ESD)

Maximum ratings

Ambient temperature	T_A	- 25/+ 85	°C	—
Storage temperature	T_{stg}	- 40/+ 85	°C	—
DC voltage	V_{DC}	0	V	—
Source power	P_s	15	dBm	source impedance 50 Ω

B 504

70,00 MHz

Characteristics

Ambient temperature	$T_A = 25\text{ °C}$
Source impedance	$Z_S = 50\ \Omega$
Load impedance	$Z_L = 50\ \Omega$
Group delay aperture	400 kHz

		min.	typ.	max.	
Center frequency (center between 3 dB points)	f_c	69,96	70,00	70,04	MHz
Insertion attenuation at f_c	α_c	38,3	39,3	40,3	dB
Pass bandwidth					
$\alpha_{rel} \leq 1\text{ dB}$	$B_{1\text{dB}}$	1,03	1,08	1,13	MHz
$\alpha_{rel} \leq 3\text{ dB}$	$B_{3\text{dB}}$	1,57	1,62	1,67	MHz
$\alpha_{rel} \leq 40\text{ dB}$	$B_{40\text{dB}}$	3,74	3,79	3,84	MHz
Amplitude ripple (p-p) 69,70 ... 70,30 MHz		—	0,3	0,4	dB
Relative attenuation (relative to α_c)	α_{rel}				
25,00 ... 67,90 MHz		50,0	54,0	—	dB
72,10 ... 77,00 MHz		38,0	40,0	—	dB
77,00 ... 100,00 MHz		46,0	52,0	—	dB
Reflected wave signal suppression 1,1 μs ... 6,1 μs after main pulse		55,0	62,0	—	dB
Group delay at f_c	τ_c	—	2,0	—	μs
Group delay ripple (p-p) 68,70 ... 71,30 MHz	$\Delta\tau$	—	4	10	ns
Temperature coefficient of frequency	TC_f	—	- 0,035	—	ppm/K ²
Frequency inversion temperature	T_0	—	25	—	°C

Temperature dependance of f_c : $f_c(T_A) = f_c(T_0) (1 + TC_f(T_A - T_0)^2)$

Frequency response

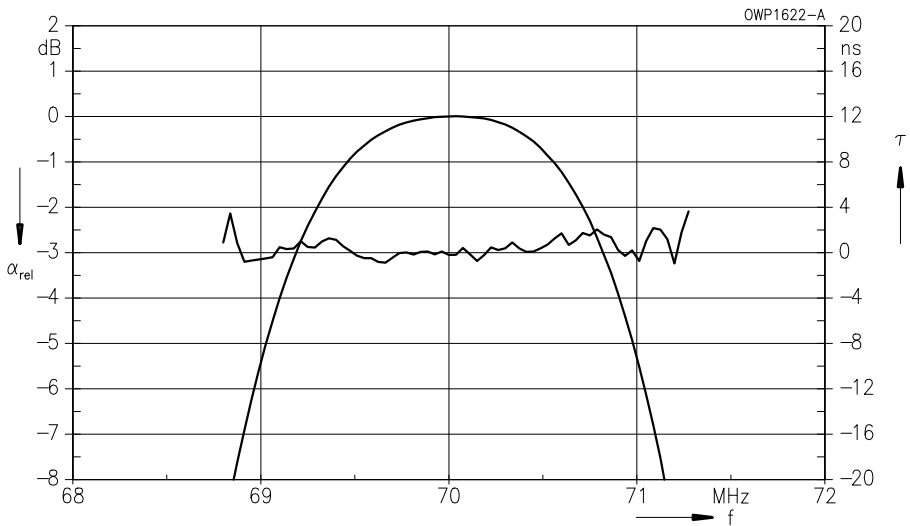
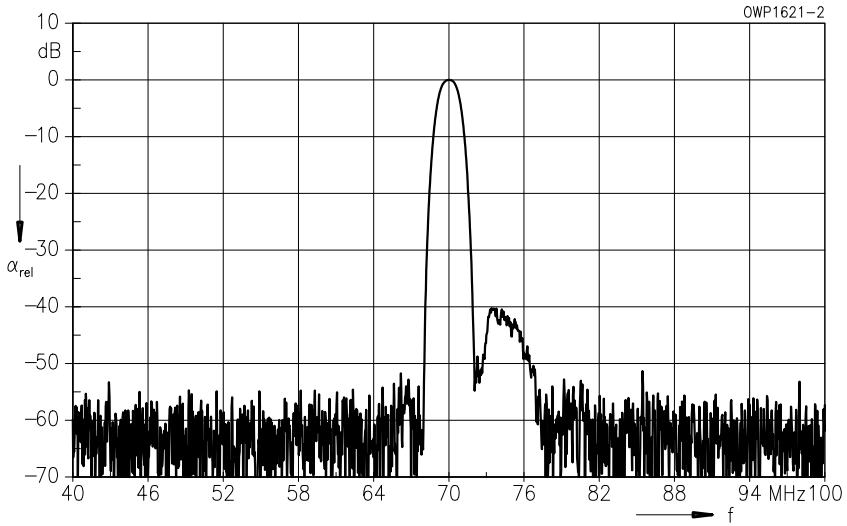

Features

- High-performance IF bandpass filter
- Constant group delay
- Hermetically sealed metal package

Terminals

- Gold-plated NiFeCo alloy

Metal package DIP 16

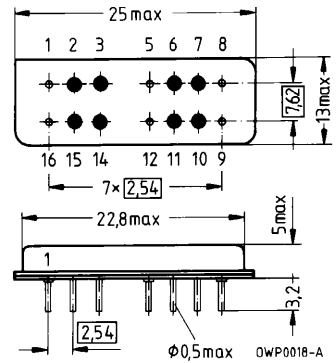

Dimensions in mm, approx. weight 4,2 g

Pin configuration

- | | |
|--------------------|-----------------|
| 3 | Input |
| 2 | Input – ground |
| 11 | Output |
| 10 | Output – ground |
| 1, 5, 8, 9, 12, 16 | Case – ground |

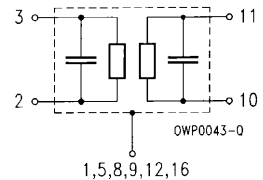

Type	Ordering code	Marking
B 521	B39121-B521-E110	Type, date code, pin 1

Electrostatic Sensitive Device (ESD)

Maximum ratings

Ambient temperature	T_A	- 25/+ 85	°C	—
Storage temperature	T_{stg}	- 40/+ 85	°C	—
DC voltage	V_{DC}	0	V	—
Source power	P_s	15	dBm	source impedance 50 Ω

Characteristics

Ambient temperature	$T_A = 35\text{ °C}$
Source impedance	$Z_S = 50\ \Omega$
Load impedance	$Z_L = 50\ \Omega$
Group delay aperture	200 kHz

		min.	typ.	max.	
Center frequency (center between 3 dB points)	f_c	117,80	118,00	118,20	MHz
Insertion attenuation at f_c	α_c	20,0	22,0	24,0	dB
Amplitude ripple (p-p) 112,80 ... 123,00 MHz		—	0,8	1,0	dB
Pass bandwidth					
$\alpha_{rel} \leq 1\text{ dB}$	$B_{1\text{dB}}$	10,7	10,9	11,1	MHz
$\alpha_{rel} \leq 3\text{ dB}$	$B_{3\text{dB}}$	11,8	11,9	12,0	MHz
$\alpha_{rel} \leq 40\text{ dB}$	$B_{40\text{dB}}$	15,4	15,55	15,7	MHz
Relative attenuation (relative to α_c)	α_{rel}				
100,00 ... 107,00 MHz		50,0	52,0	—	dB
107,00 ... 108,70 MHz		45,0	48,0	—	dB
108,70 ... 109,80 MHz		50,0	55,0	—	dB
126,20 ... 136,00 MHz		50,0	53,0	—	dB
Reflected wave signal suppression 0,9 μs ... 4,7 μs after main pulse		48,0	52,0	—	dB
Group delay at f_c	τ_c	—	1,3	—	μs
Group delay ripple (p-p) 112,00 ... 124,00 MHz	$\Delta\tau$	—	25	35	ns
Temperature coefficient of frequency	TC_f	—	-87	—	ppm/K

Frequency response

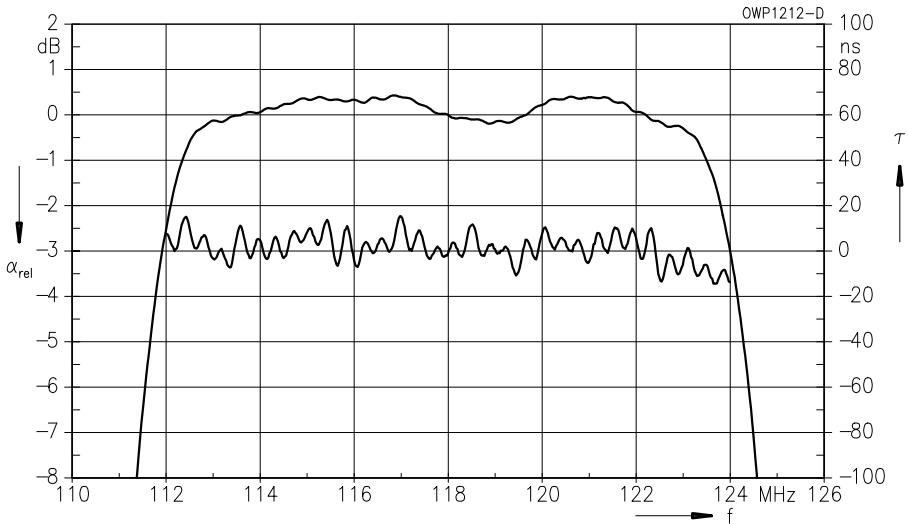
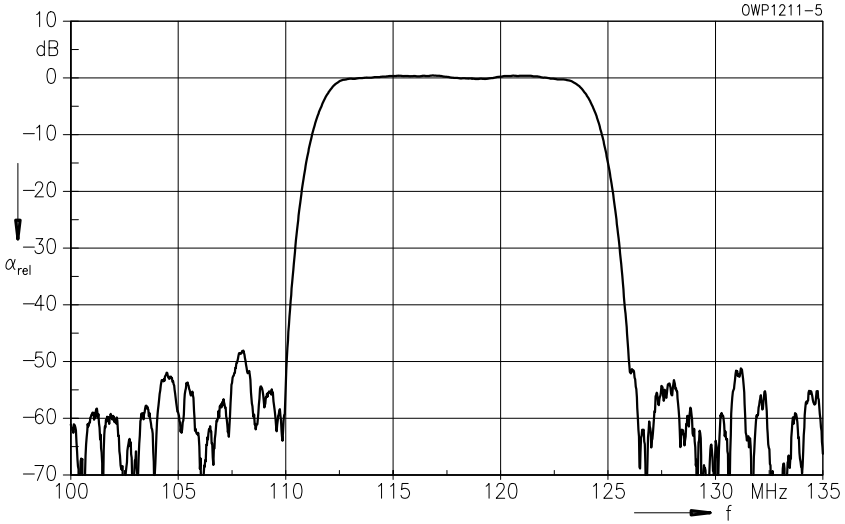

Features

- High-performance IF bandpass filter
- Constant group delay
- Hermetically sealed metal package

Terminals

- Gold-plated NiFeCo alloy

Metal package DIP 16

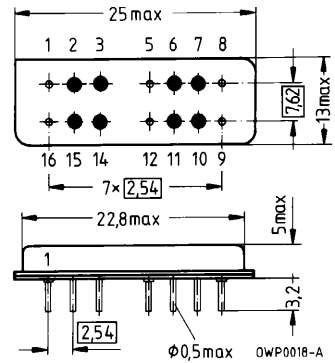

Dimensions in mm, approx. weight 4,2 g

Pin configuration

- | | |
|--------------------|-----------------|
| 3 | Input |
| 2 | Input – ground |
| 11 | Output |
| 10 | Output – ground |
| 1, 5, 8, 9, 12, 16 | Case – ground |

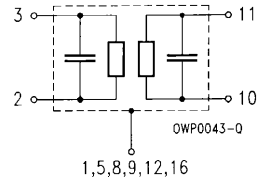

Type	Ordering code	Marking
B 1505	B39291-B1505-E110	Type, date code, pin 1

Electrostatic Sensitive Device (ESD)

Maximum ratings

Ambient temperature	T_A	- 25/+ 85	°C	—
Storage temperature	T_{stg}	- 40/+ 85	°C	—
DC voltage	V_{DC}	0	V	—
Source power	P_s	15	dBm	source impedance 50 Ω

B 1505

287,35 MHz

Characteristics

Ambient temperature	$T_A = 25\text{ °C}$
Source impedance	$Z_S = 50\ \Omega$
Load impedance	$Z_L = 50\ \Omega$
Group delay aperture	120 kHz

		min.	typ.	max.	
Center frequency (center between 3 dB points)	f_c	287,25	287,35	287,45	MHz
Insertion attenuation at f_c	α_c	19,5	20,5	21,5	dB
Pass bandwidth					
$\alpha_{rel} \leq 1\text{ dB}$	$B_{1\text{dB}}$	0,625	0,645	0,665	MHz
$\alpha_{rel} \leq 3\text{ dB}$	$B_{3\text{dB}}$	1,04	1,07	1,10	MHz
$\alpha_{rel} \leq 30\text{ dB}$	$B_{30\text{dB}}$	2,59	2,62	2,65	MHz
Relative attenuation (relative to α_c)	α_{rel}				
45,00 ... 280,00 MHz		55,0	60,0	—	dB
280,00 ... 285,70 MHz		39,0	43,0	—	dB
288,80 ... 295,00 MHz		40,0	43,0	—	dB
295,00 ... 400,00 MHz		48,0	52,0	—	dB
Reflected wave signal suppression 1,4 μs ... 4,6 μs after main pulse		40,0	48,0	—	dB
Group delay at f_c	τ_c	—	1,3	—	μs
Group delay ripple (p-p) 286,50 ... 288,00 MHz	$\Delta\tau$	—	30	50	ns
Temperature coefficient of frequency	TC_f	—	-0,035	—	ppm/K ²
Frequency inversion temperature	T_0	—	20	—	°C

Temperature dependence of f_c : $f_c(T_A) = f_c(T_0) (1 + TC_f(T_A - T_0)^2)$

Frequency response

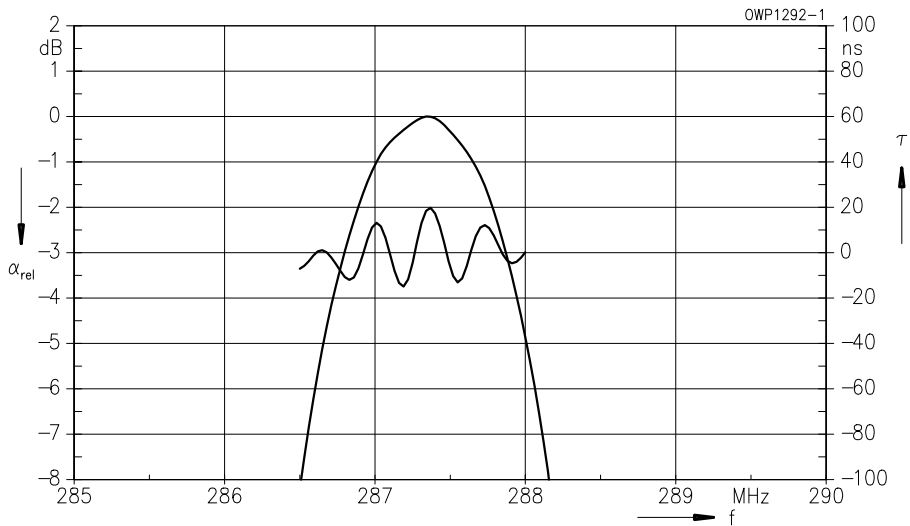
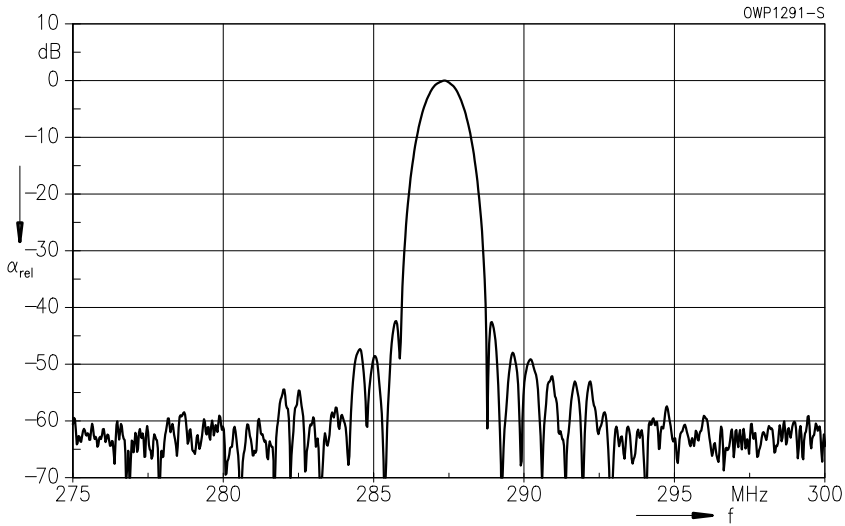

Features

- High-performance IF bandpass filter
- Constant group delay
- Hermetically sealed metal package

Terminals

- Gold-plated NiFeCo alloy

Metal package TO 8

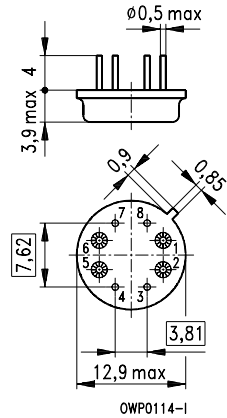

Dimensions in mm, approx. weight 1,7 g

Pin configuration

- 1 Input
- 2 Input – ground
- 5 Output
- 6 Output – ground
- 3, 4, 7, 8 Case – ground

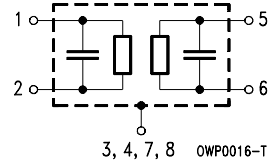

Type	Ordering code	Marking
B 558	B39441-B558-C210	Type, date code

Electrostatic Sensitive Device (ESD)

Maximum ratings

Ambient temperature	T_A	- 25/+ 85	°C	—
Storage temperature	T_{stg}	- 40/+ 85	°C	—
DC voltage	V_{DC}	0	V	—
Source power	P_s	15	dBm	source impedance 50 Ω

Characteristics

Ambient temperature	$T_A = 25\text{ °C}$
Source impedance	$Z_S = 50\ \Omega$
Load impedance	$Z_L = 50\ \Omega$
Group delay aperture	100 kHz

		min.	typ.	max.	
Center frequency (center between 3 dB points)	f_c	439,6	439,85	440,1	MHz
Insertion attenuation at f_c	α_c	—	21,0	22,0	dB
Amplitude ripple (p-p) 439,70 ... 440,00 MHz	$\Delta\alpha$	—	0,2	0,4	dB
Pass bandwidth					
$\alpha_{rel} \leq 1\text{ dB}$	$B_{1\text{dB}}$	1,25	1,37	—	MHz
$\alpha_{rel} \leq 3\text{ dB}$	$B_{3\text{dB}}$	1,80	1,90	—	MHz
$\alpha_{rel} \leq 40\text{ dB}$	$B_{40\text{dB}}$	—	4,10	4,30	MHz
Relative attenuation (relative to α_c)	α_{rel}				
390,00 ... 434,85 MHz		42,0	47,0	—	dB
434,85 ... 437,50 MHz		40,0	45,0	—	dB
442,20 ... 444,85 MHz		40,0	45,0	—	dB
444,85 ... 490,00 MHz		42,0	47,0	—	dB
Reflected wave signal suppression 1,0 μs ... 3,0 μs after main pulse		40,0	45,0	—	dB
Group delay at f_c	τ_c	1050	1090	1130	ns
Group delay ripple (p-p) 439,70 ... 440,00 MHz	$\Delta\tau$	—	20	25	ns
Temperature coefficient of frequency	TC_f	—	- 0,03	—	ppm/K ²
Frequency inversion temperature	T_0	10	20	30	°C

Temperature dependence of f_c : $f_c(T_A) = f_c(T_0) (1 + TC_f(T_A - T_0)^2)$

Frequency response

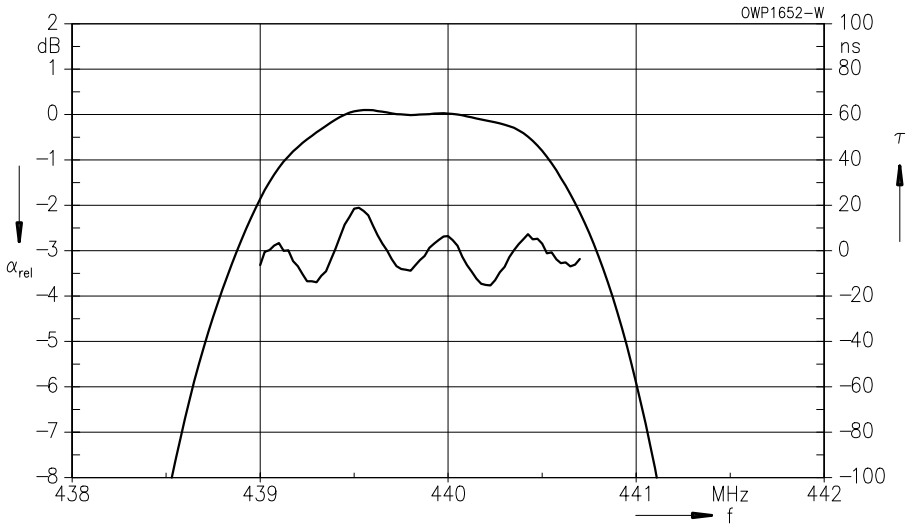
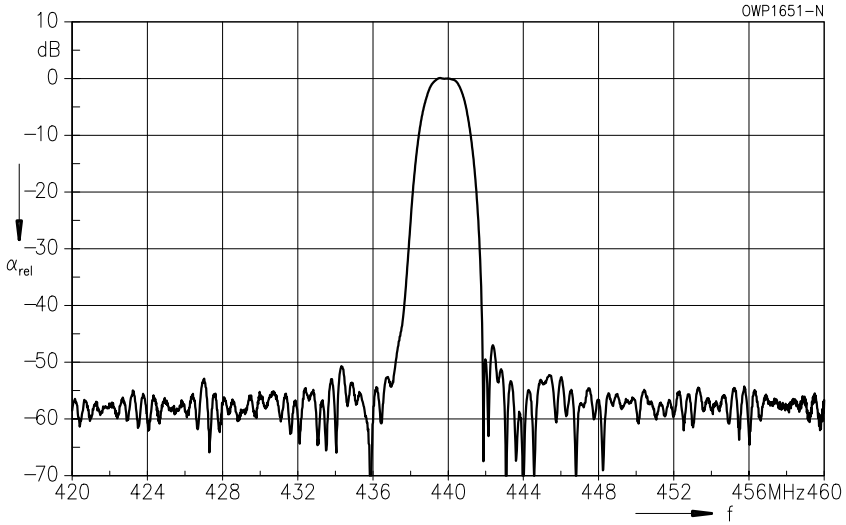

Clock Recovery Filters

Survey

f_c ¹⁾	Δf_c	B_{3dB}	α_c (max.)	τ	Package	Type	Page ²⁾
MHz	kHz	kHz	dB	ns			
51,840	± 16	450	29,5	1520	DIP 16	B 5545	#
139,264	± 40	850	21,0	820	TO 8	B 5505	#
155,520	± 31	610	18,5	1130	TO 8	B 5533	326
	± 31	230	19,5	2200	DIP 16	B 5549	#
167,118	± 33	600	17,0	1180	TO 8	B 5506	#
181,043	± 37	600	17,5	1085	TO 8	B 5504	#
622,080	± 150	925	19,5	720	TO 39	B 5531	329
	± 150	2930	20,5	270	TO 8	B 5547	#
659,157	± 157	1460	18,0	580	TO 8	B 5513	#
2488,320	± 870	6300 ³⁾	21,0	155	TO 39	B 5534	#

1) For explanation of symbols see individual data sheets or index of symbols on page [347](#)

2) Filters marked by the sign # are only listed in the survey. Detailed information on these types upon request.

3) 6 dB bandwidth

Features

- Passive or active timing recovery for digital transmission systems
- Hermetically sealed metal package

Terminals

- Gold-plated NiFeCo alloy

Metal package TO 8

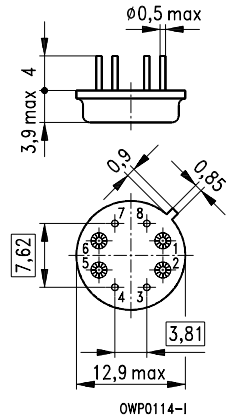

Dimensions in mm, approx. weight 1,7 g

Pin configuration

- 1 Input
- 2 Input – ground
- 5 Output
- 6 Output – ground
- 3, 4, 7, 8 Case – ground

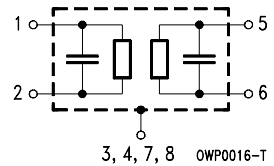

Type	Ordering code	Marking
B 5533	B39161-B5533-C210	Type, date code

Electrostatic Sensitive Device (ESD)

Maximum ratings

Ambient temperature	T_A	- 45/+ 85	°C	—
Storage temperature	T_{stg}	- 45/+ 85	°C	—
DC voltage	V_{DC}	5	V	—
Source power	P_s	0	dBm	source impedance 50 Ω

Characteristics

Ambient temperature	$T_A = 25\text{ °C}$
Source impedance	$Z_S = 50\ \Omega$
Load impedance	$Z_L = 50\ \Omega$
Group delay aperture	300 kHz

		min.	typ.	max.	
Center frequency (center between 3 dB points)	f_c	155,489	155,520	155,551	MHz
Insertion attenuation at f_c	α_c	16,0	17,0	18,5	dB
Pass bandwidth $\alpha_{rel} \leq 3\text{ dB}$	B_{3dB}	580	610	640	kHz
Phase at 155,52 MHz	φ_N	—	70	—	°
Relative attenuation (relative to α_c) First sidelobes	α_{rel}	23	25	—	dB
Group delay at f_c	τ_c	1100	1130	1160	ns
Ageing of f_c		—	—	+50/-100	ppm
Temperature coefficient of frequency	TC_f	—	- 0,03	—	ppm/K ²
Frequency inversion temperature	T_0	80	90	100	° C

Temperature dependence of f_c : $f_c(T_A) = f_c(T_0) (1 + TC_f (T_A - T_0)^2)$

Phase tolerance $\Delta\varphi_N$: $\Delta\varphi_N = -\Delta f_c \cdot \tau_{c,max} \cdot 360\text{ °}$

B 5533
155,52 MHz

Frequency response

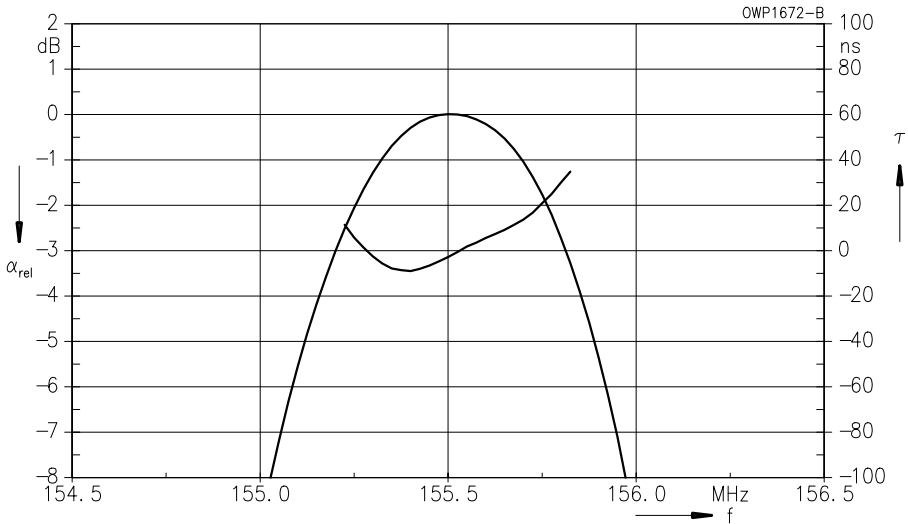
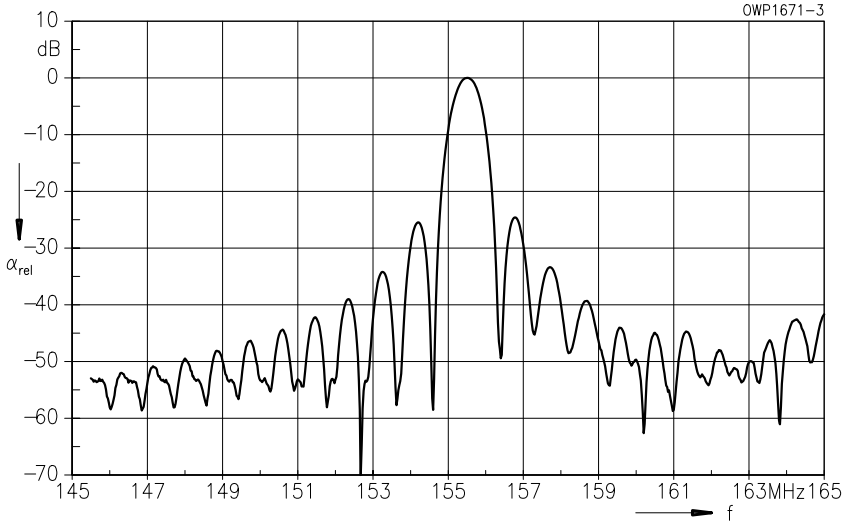

Features

- Passive or active timing recovery for digital transmission systems
- Hermetically sealed metal package

Terminals

- Gold-plated NiFeCo alloy

Metal package TO 39

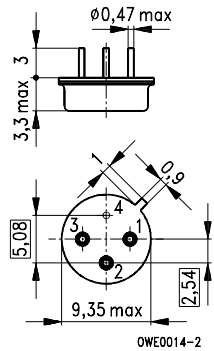

Dimensions in mm, approx. weight 1,0 g

Pin configuration

- 1 Input
- 2 Not connected
- 3 Output
- 4 Input – ground
Output – ground
Case – ground

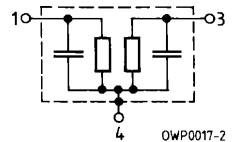

Type	Ordering code	Marking
B 5531	B39621-B5531-B210	Type, date code

Electrostatic Sensitive Device (ESD)

Maximum ratings

Ambient temperature	T_A	- 45/+ 85	°C	—
Storage temperature	T_{stg}	- 45/+ 85	°C	—
DC voltage	V_{DC}	5	V	—
Source power	P_s	0	dBm	source impedance 50 Ω

B 5531
622,08 MHz

Characteristics

Ambient temperature	$T_A = 25\text{ °C}$
Source impedance	$Z_S = 50\ \Omega$
Load impedance	$Z_L = 50\ \Omega$
Group delay aperture	250 kHz

		min.	typ.	max.	
Center frequency (center between 6 dB points)	f_c	621,93	622,08	622,23	MHz
Insertion attenuation at f_c	α_c	16,5	18,0	19,5	dB
Pass bandwidth $\alpha_{rel} \leq 3\text{ dB}$	$B_{3\text{dB}}$	840	925	1010	kHz
Phase at 622,05 MHz	φ_N	—	0	—	°
Relative attenuation (relative to α_c) First sidelobes	α_{rel}	22,0	24,0	—	dB
Group delay at f_c	τ_c	660	720	780	ns
Aging of f_c		—	—	+50/–100	ppm
Temperature coefficient of frequency	TC_f	—	– 0,03	—	ppm/K ²
Frequency inversion temperature	T_0	25	35	45	° C

Temperature dependence of f_c : $f_c(T_A) = f_c(T_0) (1 + TC_f (T_A - T_0)^2)$

Phase tolerance $\Delta\varphi_N$: $\Delta\varphi_N = -\Delta f_c \cdot \tau_{c,\text{max}} \cdot 360\text{ °}$

Frequency response

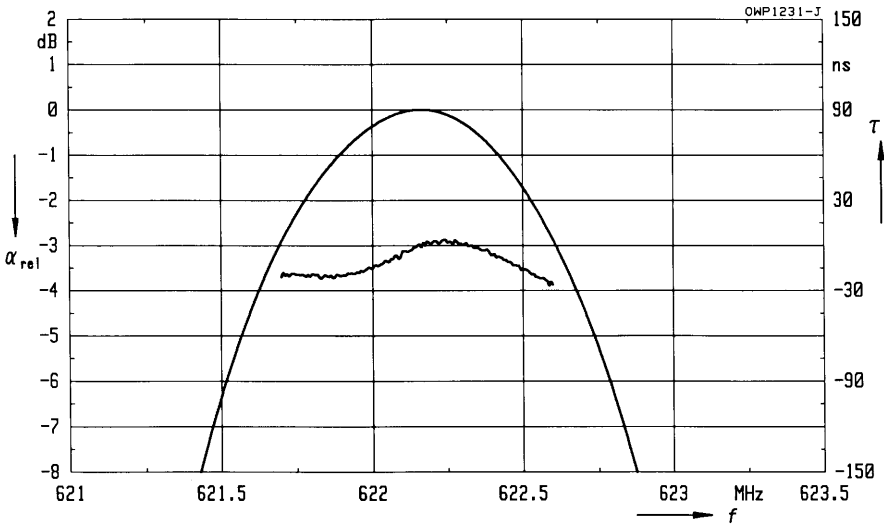
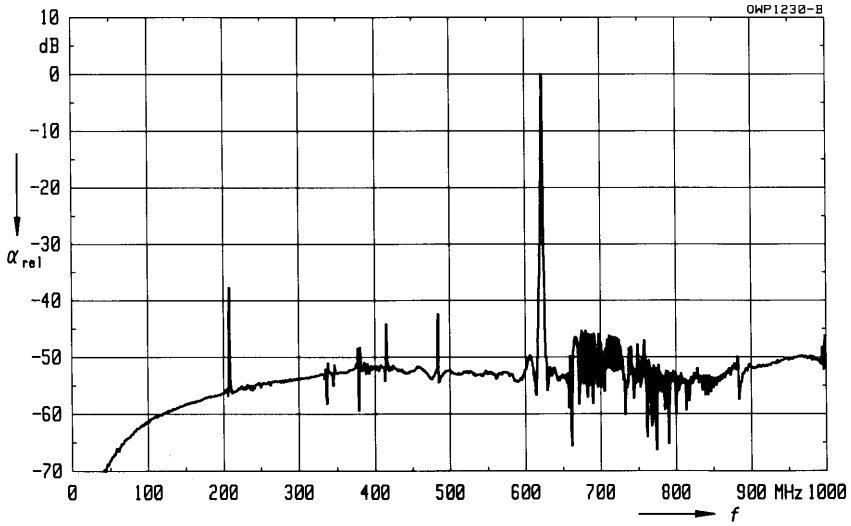



Siemens Matsushita Components

All varistors from SCS stock

Our number is the right number...

...for varistors right for your application and right to your door.

- ▶ Untaped disks S05 through S20 with rated voltages from 11 to 460 V
- ▶ **New:** taped disks S05 through S14 with rated voltages from 14 to 300 V
- ▶ **New:** SMDs in sizes 0603 through 2220 with rated voltages from 4 to 60 V.

Of course, just ask and you can also have block and strap varistors as well as PowerDisks and energy elements.

SCS – dependable, fast and competent









Resonators



Survey

Center frequency MHz	Tolerance kHz	Unloaded Q_U	Insertion attenuation dB	Package	Type	Page ¹⁾
-------------------------	------------------	----------------	--------------------------------	---------	------	--------------------

1-port resonators

314,50	75	12300	2,0	TO 39	R 660	#
	100	15000	1,5	QCC 8 	R 706	#
315,00	75	12300	2,0	TO 39	R 639	#
	85	15000	1,5	QCC 8 	R 705	#
417,50	100	9000	1,4	QCC 8 	R 704	#
418,00	75	10500	1,8	TO39	R 643	#
	75	9000	1,4	QCC 8 	R 703	334
423,22	75	11000	1,8	TO 39	R 644	#
433,42	75	10500	1,8	TO 39	R 647	#
	75	8200	1,6	QCC 8 	R 702	#
433,92	75	10500	1,7	TO 39	R 641	336
	75	8200	1,7	QCC 8 	R 701	#

2-port resonators

213,80	64	10000	9,1	TO 39	R 2637	#
224,50	67	9300	8,5	TO 39	R 2523	#
304,35	75	8400	7,3	TO 39	R 2653	#
315,05	100	7550	5,5	TO 39	R 2622	#
403,55	120	6700	7,5	TO 39	R 2526	#
407,35	100	8800	8,6	TO 39	R 2635	#
414,25	100	6800	7,0	TO 39	R 2620	#
418,00	80	6700	7,5	TO 39	R 2528	#
	75	7200	9,2	QCC 8 	R 2702	338
418,05	100	7400	8,3	TO 39	R 2630	#
423,22	75	6800	7,3	TO 39	R 2531	#
433,92	75	7200	7,8	TO 39	R 2632	340
	75	7800	9,2	QCC 8 	R 2701	#
849,25	300	4900	11,0	TO 39	R 2533	#

Frontend filters for remote control

314,00	150	700	2,5	TO 39	B 3532	#
315,00	150	700	2,5	TO 39	B 3531	#
403,55	150	950	2,5	TO 39	B 3533	#
433,92	150	950	2,3	TO 39	B 3530	343

1) Types marked by the sign # are only listed in the survey. Detailed information upon request.

Features

- 1-port resonator
- Hermetically sealed ceramic SMD package

Terminals

- Gold-plated Ni

Ceramic package QCC 8

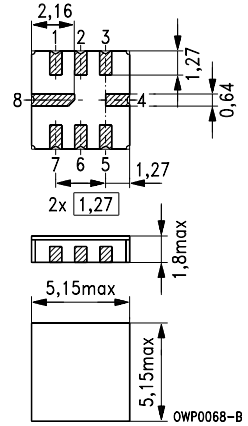

Dimensions in mm, approx. weight 0,13 g

Pin configuration

- 2 Input 1
- 6 Ground
- 4, 8 Ground (case)

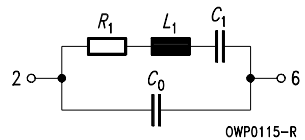

Type	Ordering code	Marking
R 703	B39421-R703-Z010	Type, date code

Electrostatic Sensitive Device (ESD)

Maximum ratings

Ambient temperature	T_A	- 45/+ 85	°C	—
Storage temperature	T_{stg}	- 45/+ 85	°C	—
DC voltage	V_{DC}	12	V	between any terminals
AC voltage	V_{pp}	12	V	between any terminals
Power dissipation	P_{max}	0	dBm	—

Characteristics

Ambient temperature $T_A = 25\text{ °C}$
 Source impedance $Z_S = 50\ \Omega$
 Load impedance $Z_L = 50\ \Omega$

		min.	typ.	max.	
Center frequency	f_c	417,925	418,000	418,075	MHz
Minimum insertion attenuation	α_{\min}	—	1,4	2,0	dB
Unloaded quality factor	Q_U	6000	9000	—	
Ageing of f_c		—	—	± 50	ppm
Equivalent circuit elements					
Motional capacitance	C_1	—	2,0	—	fF
Motional inductance	L_1	—	72,5	—	μH
Motional resistance	R_1	—	23,0	—	Ω
Parallel capacitance	C_0	—	3,4	—	pF
Temperature coefficient of frequency	TC_f	—	- 0,03	—	ppm/K ²
Frequency inversion point	T_0	20	—	50	$^{\circ}\text{C}$

Center frequency is defined as maximum of the real part of the admittance

Temperature dependence of f_c : $f_c(T_A) = f_c(T_0)(1 + TC_f(T_A - T_0)^2)$

Features

- 1-port resonator

Metal package TO 39

Terminals

- Gold-plated NiFeCo alloy

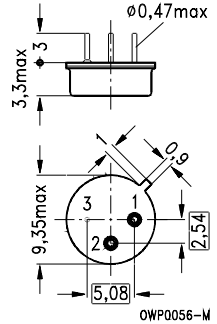

Dimensions in mm, approx. weight 1,0 g

Pin configuration

- 1 Input 1
- 2 Ground
- 3 Ground

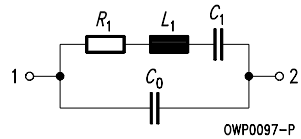

Type	Ordering code	Marking
R 641	B39431-R641-B110	Type, date code

Electrostatic Sensitive Device (ESD)

Maximum ratings

Ambient temperature	T_A	- 45/+ 85	°C	—
Storage temperature	T_{stg}	- 45/+ 85	°C	—
DC voltage	V_{DC}	12	V	between any terminals
AC voltage	V_{pp}	12	V	between any terminals
Power dissipation	P_{max}	0	dBm	—

Characteristics

Ambient temperature	$T_A = 25\text{ °C}$
Source impedance	$Z_S = 50\ \Omega$
Load impedance	$Z_L = 50\ \Omega$

		min.	typ.	max.	
Center frequency	f_c	433,845	433,920	433,995	MHz
Minimum insertion attenuation	α_{\min}	—	1,4	2,4	dB
Unloaded quality factor	Q_U	6000	10500	—	
Ageing of f_c		—	—	±50	ppm
Equivalent circuit elements					
Motional capacitance	C_1	—	1,2	—	fF
Motional inductance	L_1	—	112,1	—	μH
Motional resistance	R_1	—	26	—	Ω
Parallel capacitance	C_0	—	3,6	—	pF
Temperature coefficient of frequency	TC_f	—	-0,03	—	ppm/K ²
Frequency inversion point	T_0	20	—	50	°C

Center frequency is defined as maximum of the real part of the admittance

Temperature dependence of f_c : $f_c(T_A) = f_c(T_0)(1 + TC_f(T_A - T_0)^2)$

Features

- 2-port resonator
- Hermetically sealed SMD package

Terminals

- Gold-plated NiFeCo alloy

Ceramic package QCC 8

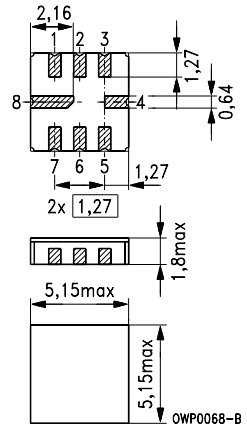

Dimensions in mm, approx. weight 0,13 g

Pin configuration

- 2 Input
- 6 Output
- 7 Ground (input)
- 3 Ground (output)

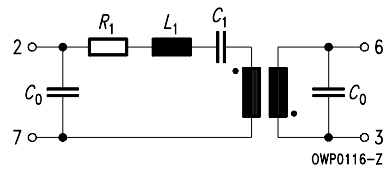

Type	Ordering code	Marking
R 2702	B39421-R2702-Z010	Type, date code

Electrostatic Sensitive Device (ESD)

Maximum ratings

Ambient temperature	T_A	- 45/+ 85	°C	—
Storage temperature	T_{stg}	- 45/+ 85	°C	—
DC voltage	V_{DC}	12	V	between any terminals
AC voltage	V_{pp}	12	V	between any terminals
Power dissipation	P_{max}	0	dBm	—

Characteristics

Ambient temperature $T_A = 25\text{ °C}$
 Source impedance $Z_S = 50\ \Omega$
 Load impedance $Z_L = 50\ \Omega$

		min.	typ.	max.	
Center frequency (center between 3 dB points)	f_c	417,925	418,000	418,075	MHz
Insertion attenuation at f_c	α	—	9,2	10,5	dB
Phase at f_c	φ	—	160	—	°el.
Loaded quality factor	Q_L	5000	7200	—	
Unloaded quality factor	Q_U	8000	10200	—	
Ageing of f_c		—	—	± 50	ppm
Equivalent circuit elements					
Motional capacitance	C_1	—	0,15	—	fF
Motional inductance	L_1	—	0,943	—	mH
Motional resistance	R_1	—	240	—	Ω
Parallel capacitance	C_0	—	2,2	—	pF
Temperature coefficient of frequency	TC_f	—	- 0,03	—	ppm/K ²
Frequency inversion point	T_0	—	40	—	°C

Center frequency is defined as maximum of the real part of the admittance
 Temperature dependence of f_c : $f_c(T_A) = f_c(T_0)(1 + TC_f(T_A - T_0)^2)$

Frequency response

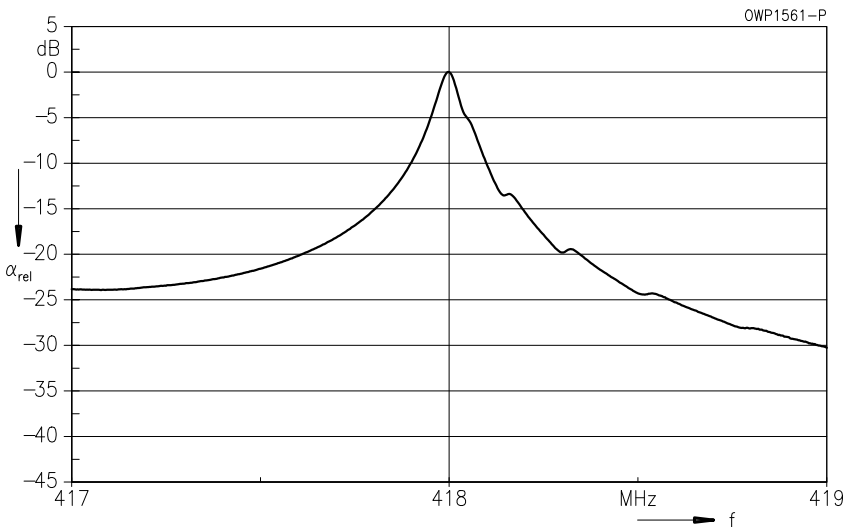

Features

- 2-port resonator

Terminals

- Gold-plated NiFeCo alloy

Metal package TO 39

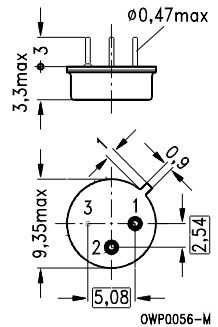

Dimensions in mm, approx. weight 1,0 g

Pin configuration

- 1 Input 1
- 2 Input 2
- 3 Ground

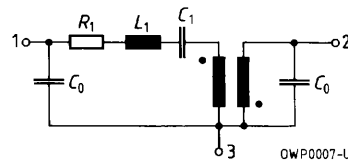

Type	Ordering code	Marking
R 2632	B39431-R2632-B110	Type, date code

Electrostatic Sensitive Device (ESD)

Maximum ratings

Ambient temperature	T_A	- 45/+ 85	°C	—
Storage temperature	T_{stg}	- 45/+ 85	°C	—
DC voltage	V_{DC}	12	V	between any terminals
AC voltage	V_{pp}	12	V	between any terminals
Power dissipation	P_{max}	0	dBm	—

Characteristics

Ambient temperature $T_A = 25\text{ }^\circ\text{C}$
 Source impedance $Z_S = 50\ \Omega$
 Load impedance $Z_L = 50\ \Omega$

		min.	typ.	max.	
Center frequency (center between 3 dB points)	f_c	433,845	433,920	433,995	MHz
Insertion attenuation at f_c	α	—	7,8	9,5	dB
Phase at f_c	φ	—	160	—	$^\circ\text{el.}$
Loaded quality factor	Q_L	5000	7200	—	
Unloaded quality factor	Q_U	9000	12200	—	
Ageing of f_c		—	—	± 50	ppm
Equivalent circuit elements					
Motional capacitance	C_1	—	0,20	—	fF
Motional inductance	L_1	—	0,67	—	mH
Motional resistance	R_1	—	145	—	Ω
Parallel capacitance	C_0	1,4	1,8	2,0	pF
Temperature coefficient of frequency	TC_f	—	- 0,03	—	ppm/K ²
Frequency inversion point	T_0	35	40	45	$^\circ\text{C}$

Center frequency is defined as maximum of the real part of the admittance

Temperature dependence of f_c : $f_c(T_A) = f_c(T_0)(1 + TC_f(T_A - T_0)^2)$

Note

For use as 1-port resonator connect pin 1 and pin 2:

Pin configuration

- 1,2 Input
- 3 Ground

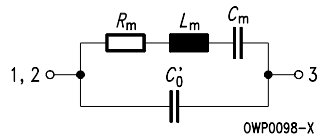

The equivalent circuit elements are calculated as follows:

$$R_m = R_1/4 \quad L_m = L_1/4 \quad C_m = 4 \cdot C_1 \quad C_0' = 2 \cdot C_0$$

R 2632
433,92 MHz

Frequency response

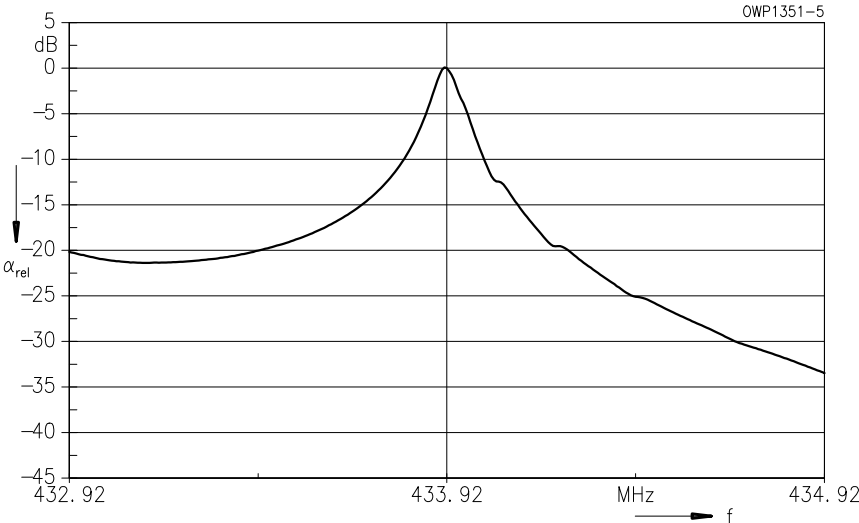

Features

- Resonator filter for remote control receivers

Metal package TO 39

Terminals

- Gold-plated NiFeCo alloy

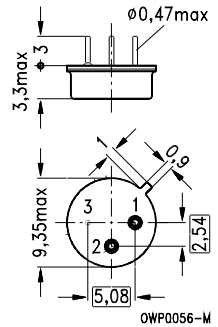

Dimensions in mm, approx. weight 1,0 g

Pin configuration

- 1 Input
- 2 Output
- 3 Ground

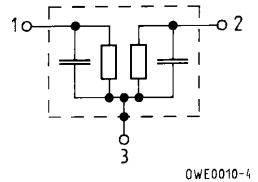

Type	Ordering code	Marking
B 3530	B39431-B3530-B110	Type, date code

Electrostatic Sensitive Device (ESD)

Maximum ratings

Ambient temperature	T_A	- 45/+ 85	°C	—
Storage temperature	T_{stg}	- 45/+ 85	°C	—
DC voltage	V_{DC}	0	V	between any terminals
AC voltage	V_{pp}	12	V	between any terminals
Power dissipation	P_{max}	0	dBm	—

B 3530

433,92 MHz

Characteristics

Ambient temperature
 Source impedance
 Load impedance

$T_A = 25\text{ °C}$
 $Z_S = 50\ \Omega$ and matching network
 $Z_L = 50\ \Omega$ and matching network

		min.	typ.	max.	
Center frequency (center between 3 dB points)	f_c	433,770	433,920	434,070	MHz
Insertion attenuation at f_c	α	—	2,3	4,0	dB
Pass bandwidth ($\alpha_{rel} \leq 3\text{ dB}$)	B_{3dB}	880	950	1000	kHz
Relative attenuation	α_{rel}				
10,00 ... 300,00 MHz		45	60	—	dB
300,00 ... 426,00 MHz		40	50	—	dB
444,00 ... 550,00 MHz		40	50	—	dB
550,00 ... 1000,00 MHz		45	60	—	dB
Ageing of f_c		—	—	± 50	ppm
Temperature coefficient of frequency ¹⁾	TC_f	—	-0,03	—	ppm/K ²
Frequency inversion point	T_0	—	30	—	°C

Temperature dependence of f_c : $f_c(T_A) = f_c(T_0)(1 + TC_f(T_A - T_0)^2)$

Matching network:

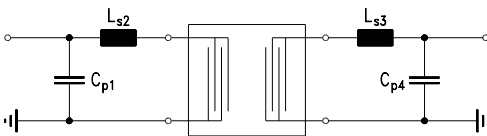

$C_{p1} = 8,2\text{ pF}$
 $L_{s2} = 62\text{ nH}$
 $L_{s3} = 62\text{ nH}$
 $C_{p4} = 8,2\text{ pF}$

0WP0060-F

Frequency response

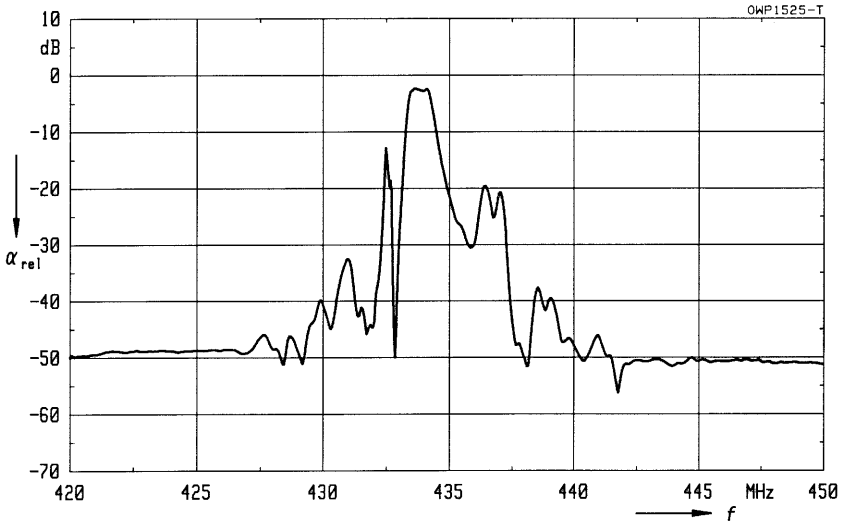



Siemens Matsushita Components

Inductive ferrite components
from SCS stock

Transformation at its best

Not just one-off solutions but complete ones designed precisely to a requirements profile are more in demand than ever. So we are offering surface-mount transformers for power and broadband applications straight from SCS stock:

- ▶ **E 6,3** with small dimensions, low leakage inductance and high electric strength
- ▶ **ER 11** flat and with low leakage inductance
- ▶ **RM 4 LP** for high DC biasing
- ▶ **S interface transformer RM 5** for precise pulse transmission in ISDN terminals
- ▶ **U interface transformer RM 6** for ISDN applications

SCS – dependable, fast and competent



Symbols and Terms

The following symbols and terms are used in the data sheets and in the chapter "General Technical Information":

Symbols Symbole	English English	German Deutsch
a	Roll-off factor	Roll-off-Faktor
B_{dB}	Pass bandwidth ($\alpha_{\text{rel}} \leq x$ dB)	Durchlaßbandbreite ($\alpha_{\text{rel}} \leq x$ dB)
C	Capacitance	Kapazität
C_0	Parallel capacitance	Parallelkapazität
C_1	Motional capacitance	Dynamische Kapazität
C_{IN}	Input capacitance	Eingangskapazität
C_{OUT}	Output capacitance	Ausgangskapazität
ESD	Electrostatic Sensitive Device	Elektrostatisch gefährdetes Bauelement
f	Frequency	Frequenz
f_c	Center frequency	Mittenfrequenz
f_N	Nominal frequency	Nennfrequenz
f_Y	Nyquist frequency	Nyquistfrequenz
k	$\sin x/x$ compensation factor	$\sin x/x$ Kompensationsfaktor
L	Inductance	Induktivität
L_1	Motional inductance	Dynamische Induktivität
P_{max}	Power dissipation	Verlustleistung
P_{IN}	Input power	Eingangsleistung
P_S	Source power (source impedance 50 Ω)	Generatorleistung (Quellimpedanz 50 Ω)
p	Partitioning factor	Aufteilungsfaktor
Q	Quality factor	Güte
Q_L	Loaded quality factor	Betriebsgüte
Q_U	Unloaded quality factor	Leerlaufgüte
R	Resistance	Widerstand
R_1	Motional resistance	Resonanzwiderstand
R_{IN}	Input resistance	Eingangswiderstand
R_{OUT}	Output resistance	Ausgangswiderstand
T_0	Frequency inversion temperature	Frequenzumkehrtemperatur
T_A	Ambient temperature	Umgebungstemperatur
T_{stg}	Storage temperature	Lagertemperatur
TC_f	Temperature coefficient of frequency	Temperaturkoeffizient der Frequenz
t	Time	Zeit
V_{DC}	DC voltage	Gleichspannung

Symbols and Terms

Symbols Symbole	English English	German Deutsch
V_{pp}	AC voltage (p-p)	Wechselspannung (Spitze-Spitze)
Z_{IN}	Input impedance	Eingangsimpedanz
Z_L	Load impedance	Lastimpedanz
Z_{OUT}	Output impedance	Ausgangsimpedanz
Z_S	Source impedance	Quellimpedanz
α	Insertion attenuation	Einfügedämpfung
α_{avg}	Average insertion attenuation	Durchschnittliche Einfügedämpfung
α_c	Insertion attenuation at f_c	Einfügedämpfung bei f_c
α_{max}	Maximum insertion attenuation	Maximale Einfügedämpfung
α_{min}	Minimum insertion attenuation	Minimale Einfügedämpfung
α_N	Insertion attenuation at f_N	Einfügedämpfung bei f_N
α_{rel}	Relative attenuation	Relative Dämpfung
$\Delta\alpha$	Amplitude ripple (p-p)	Amplitudenwelligkeit (Spitze-Spitze)
τ	Group delay	Gruppenlaufzeit
τ_c	Group delay at f_c	Gruppenlaufzeit bei f_c
τ_N	Group delay at f_N	Gruppenlaufzeit bei f_N
$\Delta\tau$	Group delay ripple (p-p) Group delay predistortion	Gruppenlaufzeitwelligkeit (Spitze-Spitze) Gruppenlaufzeitverzerrung
φ_c	Phase at f_c	Phase bei f_c
φ_N	Phase at f_N	Phase bei f_N
$\Delta\varphi$	Deviation from linear phase	Abweichung von der linearen Phase (Spitze-Spitze)
	Ageing of f_c	Alterung von f_c
	Frequency response	Frequenzgang
	Frequency response with recommended matching network	Frequenzgang mit empfohlener Anpaßschaltung
	Group delay aperture	Gruppenlaufzeitapertur
	Pass band tilt	Durchlaßbereich-Schräglage
	Feedthrough signal suppression	Unterdrückung des Übersprechens
	Reflected wave signal suppression	Unterdrückung nachlaufender Signale

Commas used in numerical values denote decimal points.

Abbreviation	Range of validity / Full text
B	Australia
B/G	CCIR, Germany, Europe
D/K	OIRT, eastern standard, China
L/L'	France
I	Great Britain
M	Japan
M/N	FCC, USA, South America
DAB	Digital Audio Broadcasting
DCR	Digital Cable Radio
DSS	Digital Satellite System
AMPS	Mobile telephone, USA (Advanced Mobile Phone System)
CT 1	Cordless telephone, Europe (Cordless Telephone, 1st Generation)
CT 2	Cordless telephone, Europe (Cordless Telephone, 2nd Generation)
CT ISM	Cordless telephone, USA (Cordless Telephone, Industrial, Scientific, Medical)
DECT	Cordless telephone, Europe (Digital European Cordless Telephone)
EGSM	Mobile telephone, Europe (Extended Global System for Mobile Communication)
ETACS	Mobile telephone, Europe, Asia (Extended Total Access Communication System)
GSM	Mobile telephone, Europe (Global System for Mobile Communication)
NTACS	Mobile telephone, Japan (Nippon Total Access Communication System)
PCN	Mobile telephone, Europe (Personal Communication Network)
PCS	Mobile telephone, USA (Personal Communication Services)

Subject Index

A

application notes for resonators	42
oscillation circuits	42
remote control system	44
application notes for TV IF filters	40
matching and driver stage	40
switchable audio filters	41
switchable video/intercarrier filters	40

B

bandpass filters	303
------------------	---------------------

C

characteristics	29
chip size	28
clock recovery filters	325
construction	27

E

echo signals	29
--------------	--------------------

F

feedthrough signals	29
filter design	28
filter impedances	30
frequency domain	29
frequency response	30

G

group delay	30
-------------	--------------------

I

IF filters for audio applications	217
IF filters for intercarrier applications	47
IF filters for quasi/split sound applications	115
IF filters for video applications	181
input transducer	27

O

operating principles	27
output transducer	27

P

phase velocity	28
pulse response	29

R

reflections	29
resonators	333

S

satellite filters	247
spectrum-shaping filters	293
spurious signals	29
step signal	39

T

temperature coefficient of frequency	33
testing	33
final measurements	33
insertion attenuation	33
pulse response	35
relative attenuation	35
scatter	35
test circuits	36
test set-up	36
TV test signals	38
time domain	29
transducer	27
triple-transit echo	29
TTE	29

V

vestigial sideband filters	273
----------------------------	---------------------

Numerics

2T signal	38
-----------	--------------------