

Power Semiconductor Module

Leading Solution

In the field of electric power solutions, producing a wide variety of products that are based on power supply technology and are highly competitive both in Korea and overseas.

Using technology that it has accumulated over more than 30 years in the electric power industry, LSIS develops, produces, and supplies a whole range of products related to power plants, power transmission & distribution, equipment for electricity users, and electric power it to overseas markets as well as within Korea.

LSIS electric equipment products are developed under the quality-first principle. Year on year, its sales in the global market have increased by 30 to 40 percent.

LSIS develops and produces various products in the field of power solutions.



Power Semiconductor Module.

Optimize your application designs : Less power loss! Save cost and time!

LSIS sets the long term goal as “**Total solution provider in power semiconductors**”, providing system solutions based on power semiconductors. LSIS is now producing and going to develop a low-cost and high-performance **Power Semiconductor Modules** for Industry applications, Power supplies, Renewable energy, Automotive and Home appliances.

Our product portfolio includes:

● Application Specific Power Module

- Simple Solution Power Module(SISPM™)
IGBT : 4-Pack
MOSFET : 2-Pack, 4-Pack, 6-Pack
- Eco Friendly Power Module(EFPM™)
MOSFET : 2-Pack, 6-Pack

● Standard Power Module

- Super Solution Power Module(SUSPM™)
IGBT : 1-Pack, 2-Pack, Chopper
DIODE : Single, Series, Common Cathode, Common Anode
- Simple Solution Power Module(SISPM™)
IGBT : 1 Φ CI, 3 Φ CI, 1 Φ CIB, 3 Φ CIB, 6-Pack

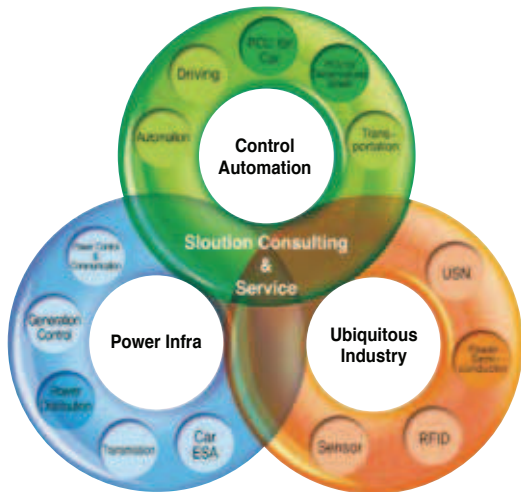

LSIS is continually discovering the new industry for the future and industrializing it.



Manufacturing Plant_Cheonan City, Korea



Head Office_Anyang City, Korea



R&D Center_Anyang City, Korea



Manufacturing Line_Cheonan City, Korea



Standard IGBT Modules

SUSPM™

Super Solution Power Modules

1-Pack, 2-Pack and Buck/Boost chopper SUSPM™ product lines for industrial applications.

These power modules are compact design with flexibility and optimized performance for each application with high reliability, which meets customers' requirements.

SUSPM™ product lines offer three standard package types (34mm, 48mm, 62mm) with the latest IGBT technology. And they cover the current range from 50A (@Tc≥80°C) to 400A (@Tc≥80°C) at 600V, 1200V and 1700V.

LS Industrial Systems provides two types of products. One is with ESD protection between Gate and Emitter, the other is without ESD protection.

Features

- Optimized characteristics for each applications
- Embedded ESD protection function (Option)
- Very low $V_{CE(sat)}$ with positive temperature coefficient

Application

- Industrial Motor Drives
- Welding machine
- Power supplies (including UPS)
- Induction Heating
- Medical



SUSPM™ Topology

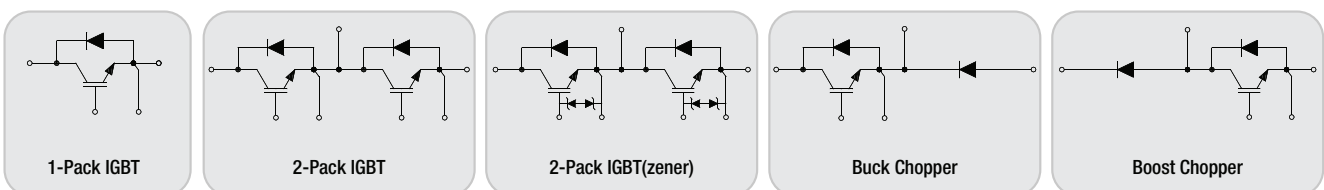

Special Functions



ESD Protection

- Protection the gate from the failure due to Electrostatic Discharge (ESD)

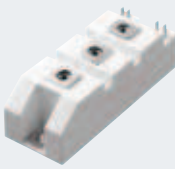
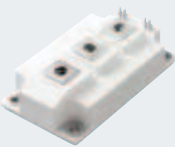
■ 1-Pack / Chopper IGBT Modules

	Configuration	600V		1200V				
		Trench F/S	Trench F/S	Trench F/S	SPT+	Trench F/S		
SUSPM1  94mm x 34mm x 30mm	Chopper -BO : BOOST -BU : BUCK	75A	LUR75G604B0 LUR75G604BU		LUR75G1204B0 LUR75G1204BU			
		100A	LUR100G604B0 LUR100G604BU		LUR100G1204B0 LUR100G1204BU			
		150A	LUR150G604B0 LUR150G604BU		LUR150G1204B0 LUR150G1204BU			
		200A	LUR200G604B0 LUR200G604BU					
SUSPM3  108mm x 62mm x 30mm	Chopper -BO : BOOST -BU : BUCK	150A			LWR150G1204B0 LWR150G1204BU			
		200A	LWR200G604B0 LWR200G604BU		LWR200G1204B0 LWR200G1204BU			
		300A	LWR300G604B0 LWR300G604BU		LWR300G1204B0 LWR300G1204BU			
		400A	LWR400G604B0 LWR400G604BU				LWR400G1207B0 LWR400G1207BU	
	1-Pack IGBT	200A						
		300A						LWA300G1207
		400A						LWA400G1207
		600A		LWA600G603				

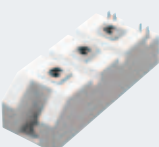
■ 2-Pack IGBT Modules

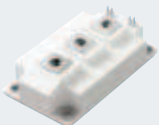
	Configuration	600V		1200V			1700V		
		Planar NPT	Trench F/S	Planar NPT	Trench F/S	SPT+	Trench F/S	Trench F/S	
SUSPM1  94mm x 34mm x 30mm		50A		LUH50G1202Z	LUH50G1204	LUH50G1201Z		LUH50G1703Z	
		75A	LUH75G602Z	LUH75G604	LUH75G1202Z	LUH75G1204	LUH75G1201Z	LUH75G1203Z	LUH75G1703Z
		100A	LUH100G602Z	LUH100G604	LUH100G1202Z	LUH100G1204	LUH100G1201Z	LUH100G1203Z	
		150A		LUH150G604		LUH150G1204			
		200A		LUH200G604					
SUSPM2  94mm x 48mm x 30mm		100A						L VH100G1703Z	
		150A	L VH150G602Z		L VH150G1202Z	L VH150G1204	L VH150G1201Z	L VH150G1203Z	L VH150G1703Z
		200A	L VH200G602Z		L VH200G1202Z	L VH200G1204	L VH200G1201Z	L VH200G1203Z	
		300A		L VH300G604					
SUSPM3  108mm x 62mm x 30mm		100A		L WH100G1202	L WH100G1204	L WH100G1201			
		150A		L WH150G1202	L WH150G1204	L WH150G1201	L WH150G1203		
		200A		L WH200G1202	L WH200G1204	L WH200G1201	L WH200G1203	L WH200G1703	
		300A		L WH300G604		L WH300G1204	L WH300G1201	L WH300G1203	L WH300G1703
400A		L WH400G604				L WH400G1207			



Standard Diode Modules

SUSPM™

Super Solution Power Modules

Standard diode modules based on SUSPM™ provide design flexibility and optimized performance for welding machines and power supplies with high reliability. Two types of package (34mm and 48mm) with latest diode technology cover current range from 150A to 300A at 600V.

Features

- Very low forward voltage drop
- Ultra fast and soft reverse recovery

Application

- Welding Machine
- Power Supply



Diode module Topology

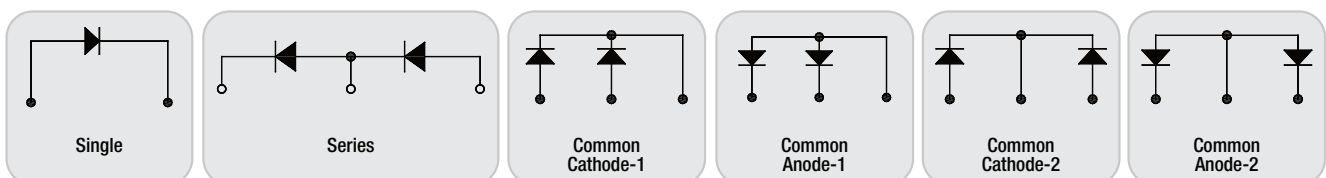



▪ Diode Modules

			Configuration	Common Terminal	600V
SUSPM1	 94mm x 34mm x 30mm	150A	Common Cathode	1	LUF150D60C1
				2	LUF150D60C2
		200A	Common Anode	1	LUF150D60A1
				2	LUF150D60A2
			Common Cathode	1	LUF200D60C1
				2	LUF200D60C2
		300A	Common Anode	1	LUF200D60A1
	2		LUF200D60A2		
	300A	Single		LUF300D60	
SUSPM2	 94mm x 48mm x 30mm	300A	Common Cathode	1	LVF300D60C1
				2	LVF300D60C2
		300A	Common Anode	1	LVF300D60A1
				2	LVF300D60A2
		300A	Series		LVF300D60S1

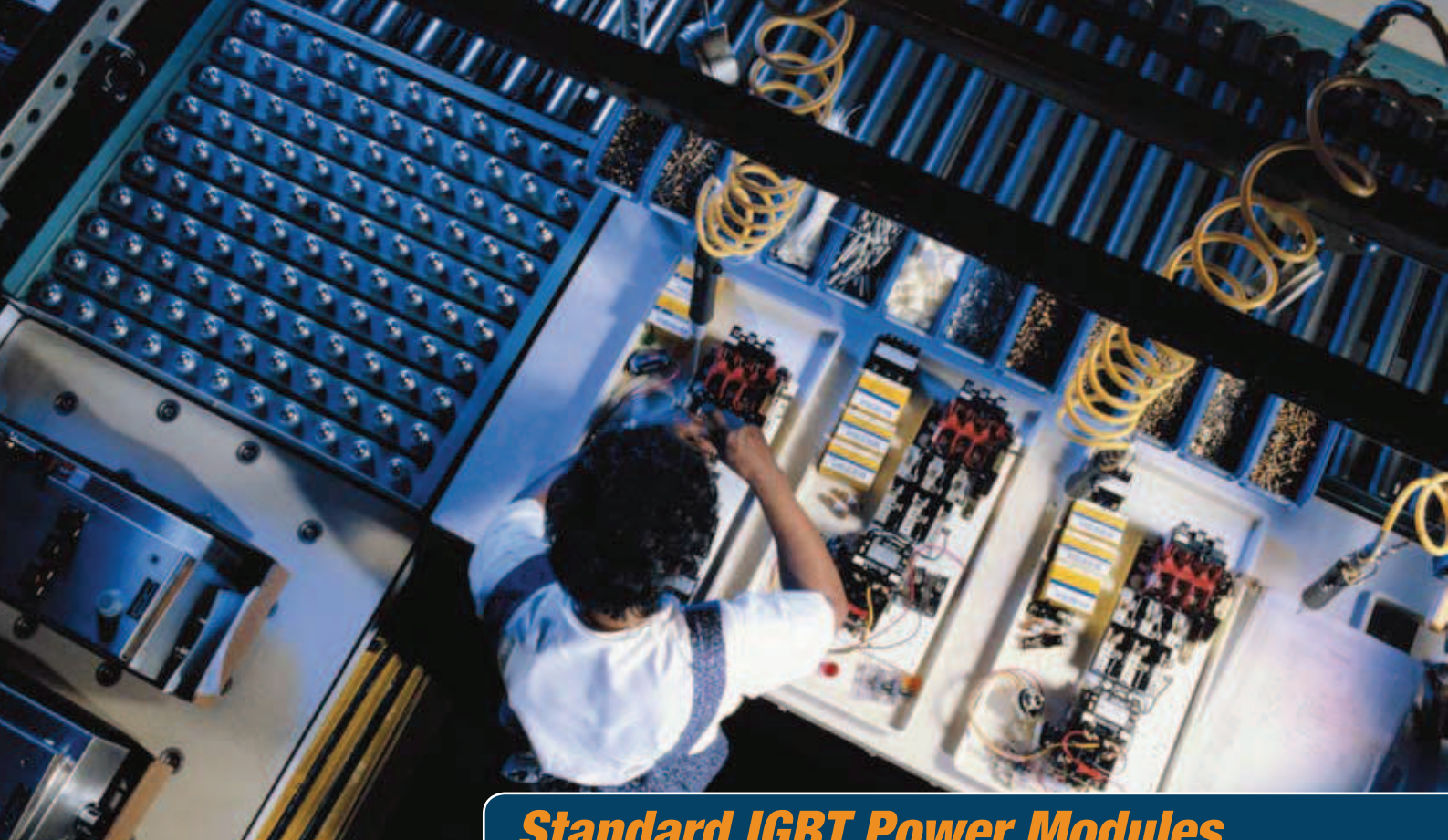

Standard IGBT Power Modules

SISPM™

Simple Solution Power Modules

CI / CIB Modules

CI and CIB SISPM™ Product lines for motor drive applications.

SISPM™ CIB modules have compact design with flexibility and optimized performance for each application with high reliability, which meets customers' requirements. SISPM™ product Line-up with two package types of SISPM0 and SISPM1 cover current range from 6A to 50A (@Tc ≥ 80°C) at 600V and 1200V. SISPM™ product Line-up with two different topologies cover various customer system requirements

- CI : 1Φ or 3Φ Converter + Inverter
- CIB : 1Φ or 3Φ Converter + Brake + Inverter

Features

- Various configurations
- The latest IGBT technology
- Operation frequency
 - Inverter & Brake up to 15kHz

Application

- General Purpose Inverter
- Servo Drive
- Sewing Machine
- Treadmill

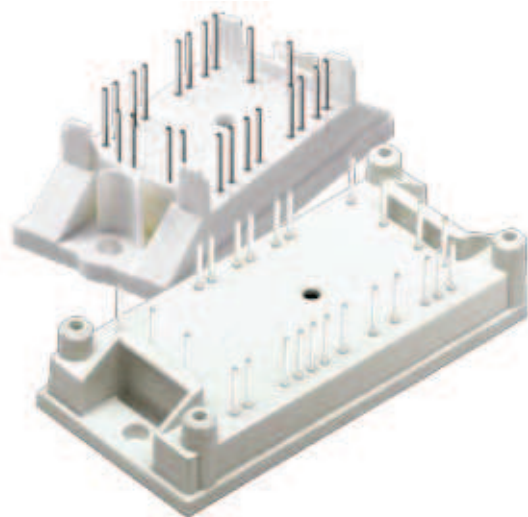

CI & CIB Modules Topology

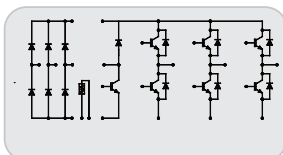
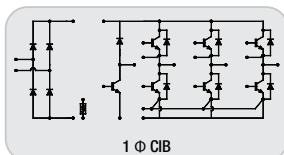
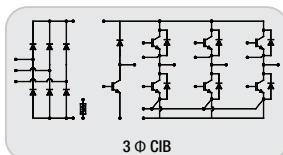
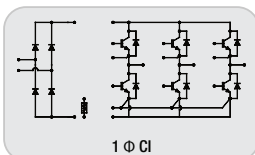
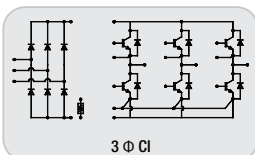

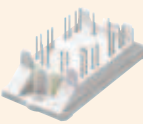
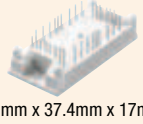

■ CI IGBT Modules

	Phase	Configuration	600V		1200V	
			Trench F/S	Trench F/S	Planar NPT	Trench F/S
			Low Vce(sat) Low Eoff	Low Vce(sat)	Low Eoff	Low Vce(sat)
SISPM0 (17mm)  55mm x 32.6mm x 17mm	3Φ	CI				LFP8G1207
						LFP15G1207
SISPM1 (17mm)  82mm x 37.4mm x 17mm	1Φ	CI				
			LEL15G604			

■ CIB (PIM) IGBT Modules

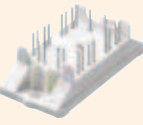
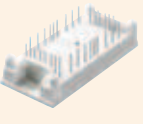
	Phase	Configuration	600V		1200V	
			Trench F/S	Trench F/S	Planar NPT	Trench F/S
			Low Vce(sat) Low Eoff	Low Vce(sat)	Low Eoff	Low Vce(sat)
SISPM0 (17mm)  55mm x 32.6mm x 17mm	3Φ	CIB (PIM)				LFC4G1207
				LFC6G603		LFC8G1207
				LFC10G603		LFC10G1207
				LFC15G603		
				LFC20G603		
				LFC30G603		
SISPM1 (17mm)  82mm x 37.4mm x 17mm	3Φ	CIB (PIM)	LEC6G604			LEC10G1207
			LEC10G604			LEC15G1207
			LEC15G604			
			LEC20G604			LEC25G1207
				LEC30G603		
				LEC50G603		



Application Specific Power Modules

SISPM™

Simple Solution Power Modules

Application Specific Power Modules

2-Pack, 4-Pack and 6-Pack Application Specific Product lines based on SISPM™ for Power supplies , welding machines, battery vehicles and charger applications

Application Specific Power Modules are consisted of MOSFETs or IGBTs and enable customers design products compact, flexible, optimized performance for each application with high reliability. SISPM1 covers current range from 30A to 400A(@Tc ≥ 80°C) at 75V, 100V, 150V, 500V, 600V, 900V and 1200V

Features

- Latest MOSFET and IGBT Technology
- Very low Rds(on)
- Operation frequency
 - MOSFET Modules : Up to 100kHz
 - IGBT Modules : Up to 40kHz
- Included temperature sensor

Application

- Battery Vehicles
- Battery Charger
- Power Supplies (including UPS)
- Welding machine
- Solar Energy

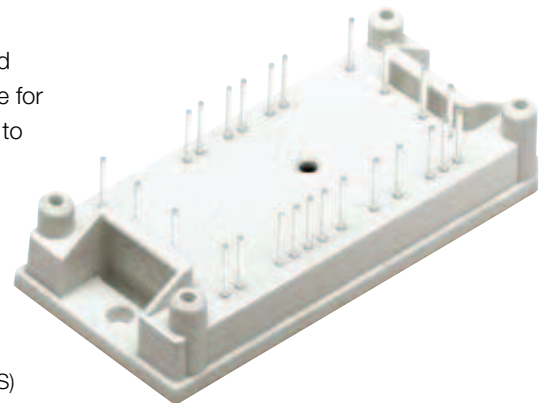

2-PACK MOSFET Modules

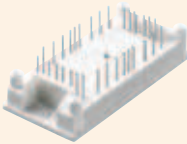
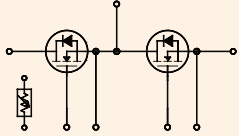
			75V	100V	150V	
SISPM1	 82mm x 37.4mm x 17mm		100A		LEH100M156	
			200A	LEH200M076	LEH200M106	LEH200M156
			400A	LEH400M076	LEH400M106	

4-Pack MOSFET Modules

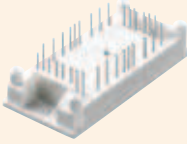
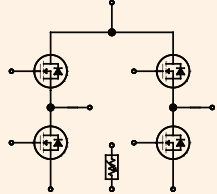
			500V	900V
SISPM1	 82mm x 37.4mm x 17mm		30A	LEF30M90T
			45A	LEF45M50T
			60A	LEF60M50T

6-Pack MOSFET Modules

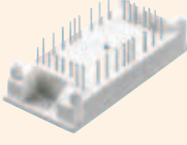
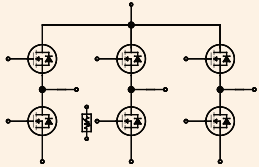
			75V	100V	150V
SISPM1	 82mm x 37.4mm x 17mm		100A		LEI100M156
			200A	LEI200M076	LEI200M106

4-Pack IGBT Modules

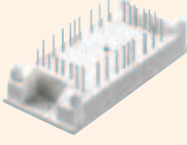
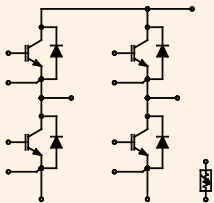
			600V	1200V	
			Planar NPT	Planar NPT	
SISPM1	 82mm x 37.4mm x 17mm		50A	LEF50G602	LEF50G1202
			75A	LEF75G602	LEF75G1202
			100A	LEF100G602	



Application Specific Power Modules

EFPM™ Eco Friendly Power Modules

EFPM1

EFPM™ product line for Battery Vehicle, Solar energy and Power supplies.

These power modules are consisted of MOSFETs and meet customers' requirements for compact design, flexibility, and optimized performance for each application with high reliability. EFPM1 covers the different current range from 300A to 600A(@Tc ≥ 80°C) at 75V, 100V and 150V

Features

- Low loss & High ruggedness MOSFET
 - Low Rds(ON)
 - Enhanced body diode dv/dt, di/dt capability
 - Improved gate, avalanche, dynamic dv/dt ruggedness
- Half bridge configuration
- Insulated package without copper base plate
- Fully characterized capacitance & avalanche SOA
- Included temperature sensor



Application

- Battery Vehicles and charger
- Solar Energy
- Power supplies

2-PACK MOSFET Modules

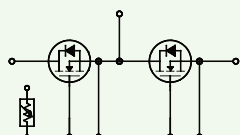
		75V	100V	150V	
EFPM1	 122mm x 45mm x 20.5mm		300A		LMH300M156
			400A		LMH400M156
			500A		LMH500M156
			600A	LMH600M076	LMH600M106



EFPM2

EFPM™ product line for Battery Vehicle, Solar energy and Power supplies

These power modules are consisted of MOSFETs, which meet the customers' requirements for compact design, flexibility and optimized performance for each application with high reliability . EFPM2 covers the different current range from 200A to 800A (@Tc=80°C) at 75V, 100V and 150V

Features

- Low loss & High ruggedness MOSFET
 - Low R_{DS(ON)}
 - Enhanced body diode dv/dt, di/dt capability
 - Improved gate, avalanche, dynamic dv/dt ruggedness
- 6-pack configuration
- Insulated package with copper base plate
- Fully characterized capacitance & avalanche SOA
- Included temperature sensor

Application

- Battery Vehicles and charger
- Solar Energy
- Power supplies

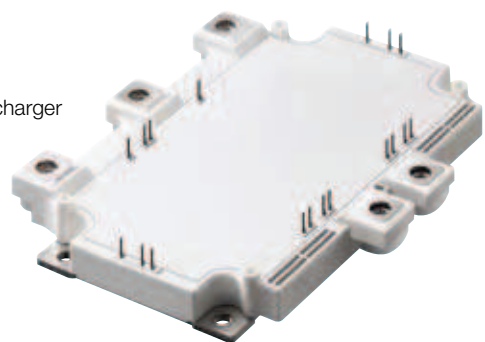

▪ 6-PACK MOSFET Modules

		75V	100V	150V
EFPM2	<p>122mm x 45mm x 20.5mm</p>			LNI200M156
				LNI300M156
		LNI400M076	LNI400M106	LNI400M156
		LNI600M076	LNI600M106	
		LNI800M076	LNI800M106	

* Note) Red color : MP from Dec. 2012





LSIS Module Application

Welding Machines	15 page
High Frequency Application (including IH)	17 page
Power Supplies (including UPS)	18 page
Industrial Motor Drive	19 page
Battery Vehicle Application	20 page

For Welding Machines

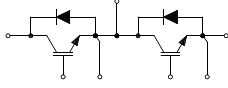
2-Pack IGBT Modules

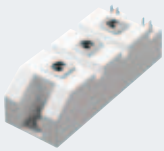

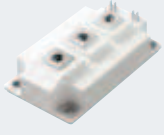
			600V		1200V			1700V	
			Planar NPT	Trench F/S	Planar NPT	Trench F/S	SPT+	Trench F/S	Trench F/S
			Low Eoff	Low Vce(sat) Low Eoff	Low Eoff	Low Vce(sat) Low Eoff	Low Vce(sat)	Low Vce(sat)	Low Vce(sat)
SUSPM1	 94mm x 34mm x 30mm	50A			LUH50G1202Z	LUH50G1204	LUH50G1201Z		LUH50G1703Z
		75A	LUH75G602Z	LUH75G604	LUH75G1202Z	LUH75G1204	LUH75G1201Z	LUH75G1203Z	LUH75G1703Z
		100A	LUH100G602Z	LUH100G604	LUH100G1202Z	LUH100G1204	LUH100G1201Z	LUH100G1203Z	
		150A		LUH150G604		LUH150G1204			
		200A		LUH200G604					
SUSPM2	 94mm x 48mm x 30mm	100A							LWH100G1703Z
		150A	LWH150G602Z		LWH150G1202Z	LWH150G1204	LWH150G1201Z	LWH150G1203Z	LWH150G1703Z
		200A	LWH200G602Z		LWH200G1202Z	LWH200G1204	LWH200G1201Z	LWH200G1203Z	
		300A		LWH300G604					
SUSPM3	 108mm x 62mm x 30mm	100A			LWH100G1202	LWH100G1204	LWH100G1201		
		150A			LWH150G1202	LWH150G1204	LWH150G1201	LWH150G1203	
		200A			LWH200G1202	LWH200G1204	LWH200G1201	LWH200G1203	LWH200G1703
		300A		LWH300G604		LWH300G1204	LWH300G1201	LWH300G1203	LWH300G1703
		400A		LWH400G604				LWH400G1207	

4-Pack IGBT Modules

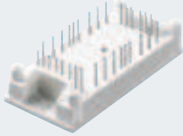
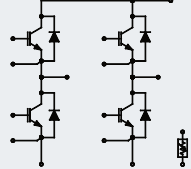

				600V	1200V
				Planar NPT	Planar NPT
SISPM1	 82mm x 37.4mm x 17mm		50A	LEF50G602	LEF50G1202
			75A	LEF75G602	LEF75G1202
			100A	LEF100G602	

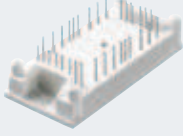
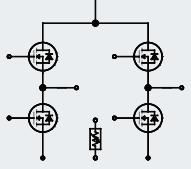
4-Pack MOSFET Modules

				500V	900V
				Planar GATE	Planar GATE
SISPM1	 82mm x 37.4mm x 17mm		30A		LEF30M90T
			45A	LEF45M50T	
			60A	LEF60M50T	

For Welding Machines

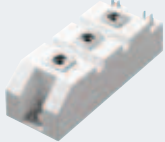
Diode Modules

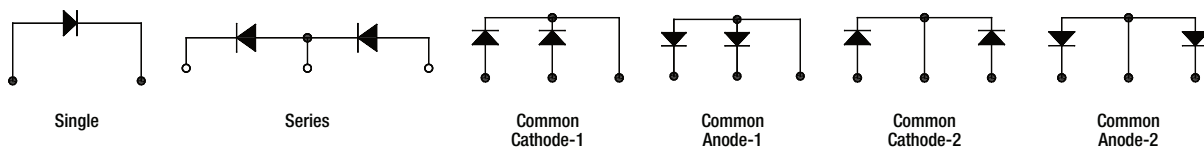

			Configuration	Common Terminal	600V
SUSPM1	 94mm x 34mm x 30mm	150A	Common Cathode	1	LUF150D60C1
				2	LUF150D60C2
			Common Anode	1	LUF150D60A1
				2	LUF150D60A2
		200A	Common Cathode	1	LUF200D60C1
				2	LUF200D60C2
		300A	Common Anode	1	LUF200D60A1
	2		LUF200D60A2		
SUSPM2	 94mm x 48mm x 30mm	300A	Common Cathode	1	LVF300D60C1
				2	LVF300D60C2
			Common Anode	1	LVF300D60A1
				2	LVF300D60A2
		300A	Series		LVF300D60S1

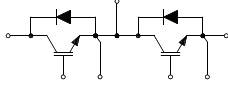

For High Frequency Application (including IH)

2-Pack IGBT Modules

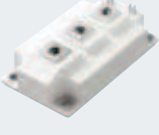

		600V		1200V			
		Planar NPT	Trench F/S	Planar NPT	Trench F/S	Trench F/S	
		Low Eoff	Low Vce(sat) Low Eoff	Low Eoff	Low Vce(sat) Low Eoff	Low Vce(sat)	
SUSPM1	 94mm x 34mm x 30mm	50A		LUH50G1202Z	LUH50G1204		
		75A	LUH75G602Z	LUH75G604	LUH75G1202Z	LUH75G1204	
		100A	LUH100G602Z	LUH100G604	LUH100G1202Z	LUH100G1204	
		150A		LUH150G604		LUH150G1204	
		200A		LUH200G604			
SUSPM2	 94mm x 48mm x 30mm	150A	L VH150G602Z		L VH150G1202Z	L VH150G1204	
		200A	L VH200G602Z		L VH200G1202Z	L VH200G1204	
		300A		L VH300G604			
		400A		L VH400G604			
SUSPM3	 108mm x 62mm x 30mm	100A			L WH100G1202	L WH100G1204	
		150A			L WH150G1202	L WH150G1204	
		200A			L WH200G1202	L WH200G1204	
		300A		L WH300G604		L WH300G1204	
		400A		L WH400G604			L WH400G1207

4-Pack IGBT Modules

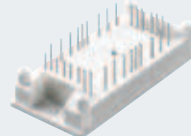
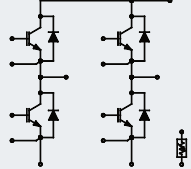
		600V		1200V	
		Planar NPT		Planar NPT	
SISPM1	 82mm x 37.4mm x 17mm		50A	LEF50G602	LEF50G1202
			75A	LEF75G602	LEF75G1202
			100A	LEF100G602	

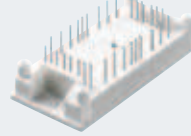
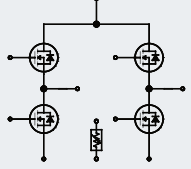

4-Pack MOSFET Modules

		500V		900V	
		Planar GATE		Planar GATE	
SISPM1	 82mm x 37.4mm x 17mm		30A		LEF30M90T
			45A	LEF45M50T	
			60A	LEF60M50T	

For Power Supplies (including UPS)

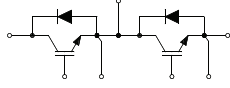
■ 2-Pack IGBT Modules

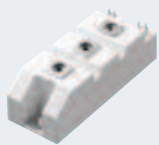

			600V			1200V				
			Planar NPT	Trench F/S	Trench F/S	Planar NPT	Trench F/S	SPT+	Trench F/S	
			Low Eoff	Low Vce(sat) Low Eoff	Low Vce(sat)	Low Eoff	Low Vce(sat) Low Eoff	Low Vce(sat)	Low Vce(sat)	
SUSPM1		94mm x 34mm x 30mm	50A				LUH50G1202Z	LUH50G1204	LUH50G1201Z	
			75A	LUH75G602Z	LUH75G604		LUH75G1202Z	LUH75G1204	LUH75G1201Z	LUH75G1203Z
			100A	LUH100G602Z	LUH100G604		LUH100G1202Z	LUH100G1204	LUH100G1201Z	LUH100G1203Z
			150A		LUH150G604					
			200A		LUH200G604					
SUSPM2		94mm x 48mm x 30mm	150A	L VH150G602Z			L VH150G1202Z	L VH150G1204	L VH150G1201Z	L VH150G1203Z
			200A	L VH200G602Z			L VH200G1202Z	L VH200G1204	L VH200G1201Z	L VH200G1203Z
			300A		L VH300G604	L VH300G603Z				
			400A		L VH400G604	L VH400G603Z				
SUSPM3		108mm x 62mm x 30mm	100A				L WH100G1202	L WH100G1204	L WH100G1201	
			150A				L WH150G1202	L WH150G1204	L WH150G1201	L WH150G1203
			200A				L WH200G1202	L WH200G1204	L WH200G1201	L WH200G1203
			300A		L WH300G604	L WH300G603		L WH300G1204	L WH300G1201	L WH300G1203
			400A		L WH400G604	L WH400G603				L WH400G1207

■ 4-Pack IGBT Modules

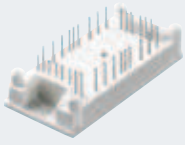
					600V	1200V
					Planar NPT	Planar NPT
					SISPM1	
				75A	LEF75G602	LEF75G1202
				100A	LEF100G602	

■ 4-Pack MOSFET Modules

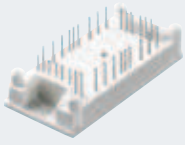
					500V	900V
					Planar GATE	Planar GATE
					SISPM1	
				45A	LEF45M50T	
				60A	LEF60M50T	

For Industrial Motor Drives

1-Pack / Chopper IGBT Modules

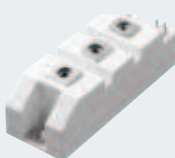
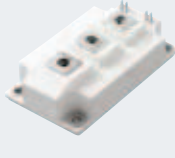
			Configuration	600V		1200V		
				Trench F/S	Trench F/S	Trench F/S	SPT+	Trench F/S
				Low Vce(sat) Low Eoff	Low Vce(sat)	Low Vce(sat) Low Eoff	Low Vce(sat)	Low Vce(sat)
SUSPM1	 94mm x 34mm x 30mm	75A	Chopper -BO : BOOST -BU : BUCK	LUR75G604B0 LUR75G604BU		LUR75G1204B0 LUR75G1204BU		
		100A		LUR100G604B0 LUR100G604BU		LUR100G1204B0 LUR100G1204BU		
		150A		LUR150G604B0 LUR150G604BU		LUR150G1204B0 LUR150G1204BU		
		200A		LUR200G604B0 LUR200G604BU				
SUSPM3	 108mm x 62mm x 30mm	150A	Chopper -BO : BOOST -BU : BUCK			LWR150G1204B0 LWR150G1204BU		
		200A		LWR200G604B0 LWR200G604BU		LWR200G1204B0 LWR200G1204BU		
		300A		LWR300G604B0 LWR300G604BU		LWR300G1204B0 LWR300G1204BU		
		400A	LWR400G604B0 LWR400G604BU				LWR400G1207B0 LWR400G1207BU	
		200A	1-Pack IGBT					
		300A						LWA300G1207
		400A						LWA400G1207
600A		LWA600G603						

2-Pack IGBT Modules

			600V		1200V		1700V	
			Trench F/S	Trench F/S	Trench F/S	SPT+	Trench F/S	
			Low Vce(sat) Low Eoff	Low Vce(sat)	Low Vce(sat) Low Eoff	Low Vce(sat)	Low Vce(sat)	
SUSPM1	 94mm x 34mm x 30mm	50A			LUH50G1204	LUH50G1201Z		LUH50G1201Z
		75A	LUH75G604	LUH75G603Z	LUH75G1204	LUH75G1201Z	LUH75G1203Z	LUH75G1703Z
		100A	LUH100G604	LUH100G603Z	LUH100G1204	LUH100G1201Z	LUH100G1203Z	
			LUH150G604	LUH150G603Z				
SUSPM2	 94mm x 48mm x 30mm	100A						LVH100G1703Z
		150A			LVH150G1204	LVH150G1201Z	LVH150G1203Z	LVH150G1703Z
		200A			LVH200G1204	LVH200G1201Z	LVH200G1203Z	
		300A	LVH300G604	LVH300G603Z				
		400A	LVH400G604	LVH400G603Z				
SUSPM3	 108mm x 62mm x 30mm	100A			LWH100G1204	LWH100G1201		
		150A			LWH150G1204	LWH150G1201	LWH150G1203	
		200A			LWH200G1204	LWH200G1201	LWH200G1203	LWH200G1703
		300A	LWH300G604	LWH300G603	LWH300G1204	LWH300G1201	LWH300G1203	LWH300G1703
400A	LWH400G604	LWH400G603			LWH400G1207			

For Industrial Motor Drives

CI IGBT Modules

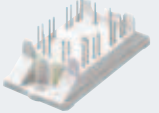
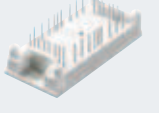

				600V		1200V	
				Trench F/S	Trench F/S	Planar NPT	Trench F/S
				Low Vce(sat) Low Eoff	Low Vce(sat)	Low Eoff	Low Vce(sat)
SISPM0 (17mm)	 55mm x 32.6mm x 17mm	8A	3Φ	CI			LFP8G1207
		10A					
		15A					LFP15G1207
		20A					
		25A					
SISPM1 (17mm)	 82mm x 37.4mm x 17mm	8A	1Φ	CI			
		10A					
		15A			LEL15G604		
		20A					

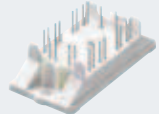
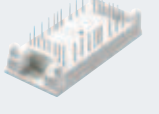
CIB (PIM) IGBT Modules

				600V		1200V	
				Trench F/S	Trench F/S	Planar NPT	Trench F/S
				Low Vce(sat) Low Eoff	Low Vce(sat)	Low Eoff	Low Vce(sat)
SISPM0 (17mm)	 55mm x 32.6mm x 17mm	4A	3Φ	CIB (PIM)			LFC4G1207
		6A				LFC6G603	
		8A					LFC8G1207
		10A				LFC10G603	LFC10G1207
		15A				LFC15G603	
		20A				LFC20G603	
		30A				LFC30G603	
SISPM1 (17mm)	 82mm x 37.4mm x 17mm	4A	3Φ	CIB (PIM)			
		6A			LEC6G604		
		10A			LEC10G604		LEC10G1207
		15A			LEC15G604		LEC15G1207
		20A			LEC20G604		
		25A					LEC25G1207
		30A				LEC30G603	
		50A				LEC50G603	

For Battery Vehicle Application

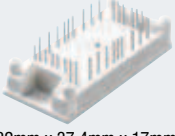
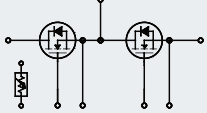
2-PACK MOSFET Modules for E-Scooter, Golf cars, NEV, Forklift and Charger

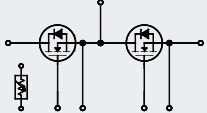
			Configuration	75V	100V	150V
SISPM1	 82mm x 37.4mm x 17mm		100A			LEH100M156
			200A	LEH200M076	LEH200M106	LEH200M156
			400A	LEH400M076	LEH400M106	
EFPM1	 122mm x 45mm x 20.5mm		300A			LMH300M156
			400A			LMH400M156
			500A			LMH500M156
			600A	LMH600M076	LMH600M106	

6-PACK MOSFET Modules for E-Scooter, Fan drive

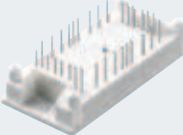
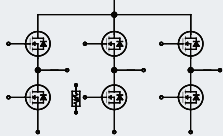
			Configuration	75V	100V	150V
SISPM1	 82mm x 37.4mm x 17mm		100A			LEI100M156
			200A	LEI200M076	LEI200M106	

6-PACK MOSFET Modules for Golf cars, NEV, Forklift

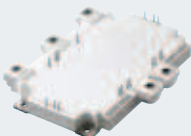
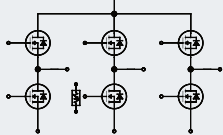
			Configuration	75V	100V	150V
EFPM2	 122mm x 45mm x 20.5mm		200A			LNI200M156
			300A			LNI300M156
			400A	LNI400M076	LNI400M106	LNI400M156
			600A	LNI600M076	LNI600M106	
			800A	LNI800M076	LNI800M106	

* Note) Red color : MP from Dec. 2012

1/2-Pack IGBT Modules for EV Quick chargers

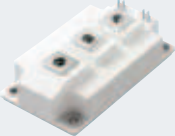
		Configuration	600V		1200V	Trench F/S	
			Trench F/S	Trench F/S	SPT+		
			Low Vce(sat) Low Eoff	Low Vce(sat)	Low Vce(sat)		
SUSPM3	 108mm x 62mm x 30mm	200A					
		300A	1-Pack IGBT				LWA300G1207
		400A					LWA400G1207
		600A		LWA600G603			
		200A	2-Pack IGBT				
		300A		LWH300G604	LWH300G603	LWH300G1204	LWH300G1201
400A		LWH400G604	LWH400G603			LWH400G1207	

SUSPM™ Package Dimension

SUSPM1 Package

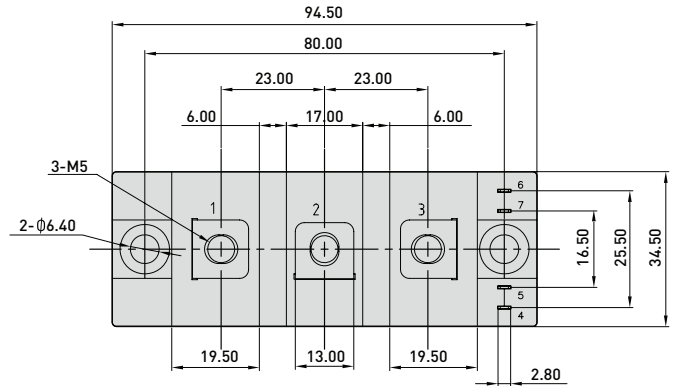
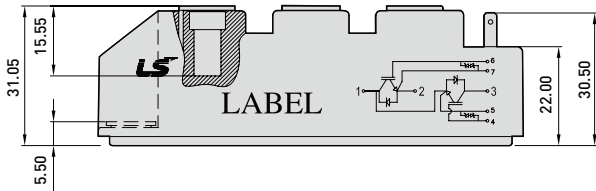

SUSPM2 Package

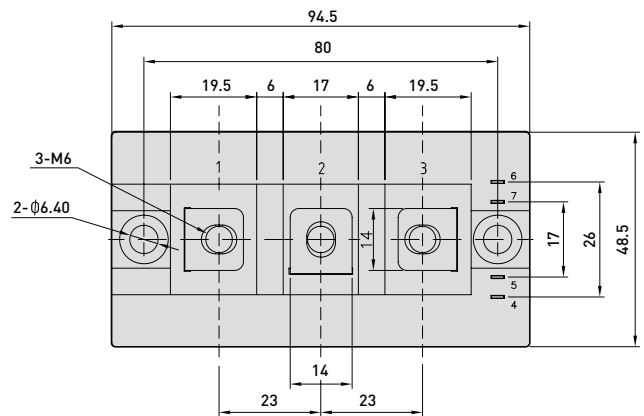
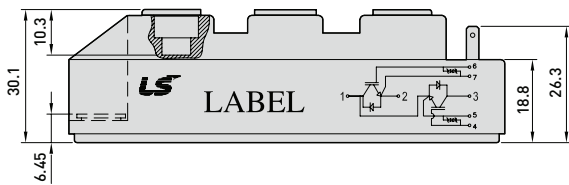

SUSPM3 Package

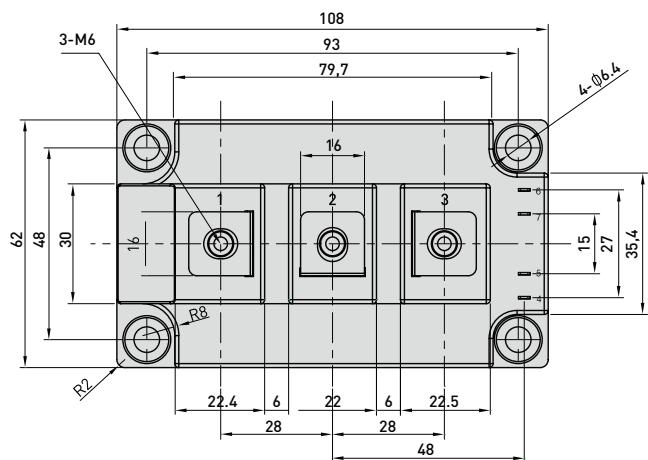
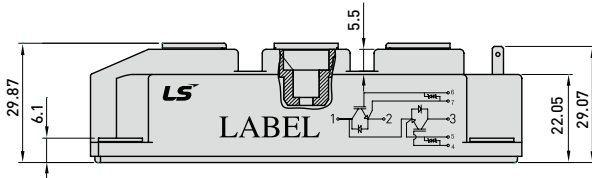

SISPMTM Package Dimension

SISPM0 3 ϕ CI / 3 ϕ CIB

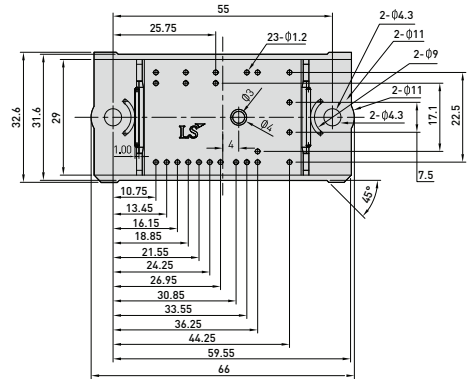
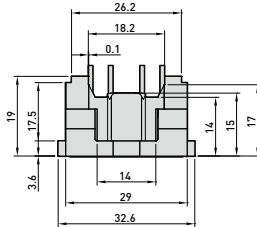
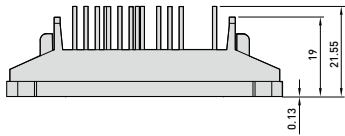

SISPM1 1 ϕ CI / 3 ϕ CIB

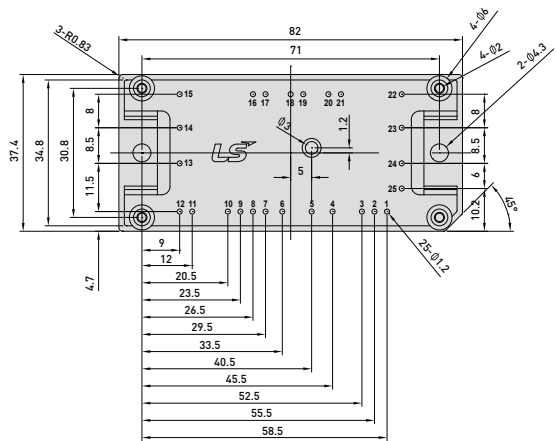
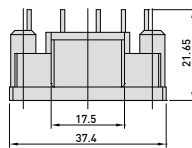
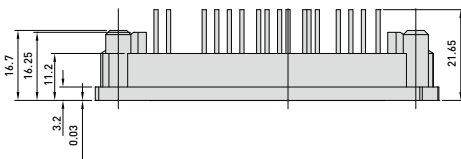

SISPM1 2PACK MOSFET / 4PACK IGBT

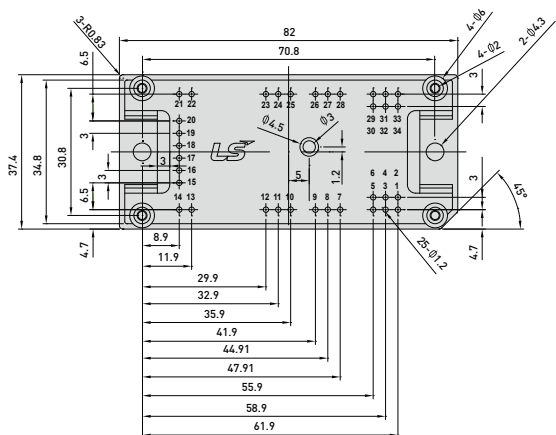
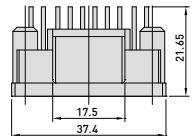
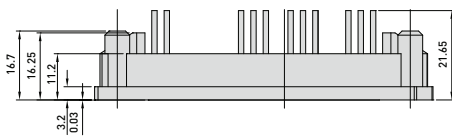

SISPMTM Package Dimension

SISPM1 4PACK MOSFET

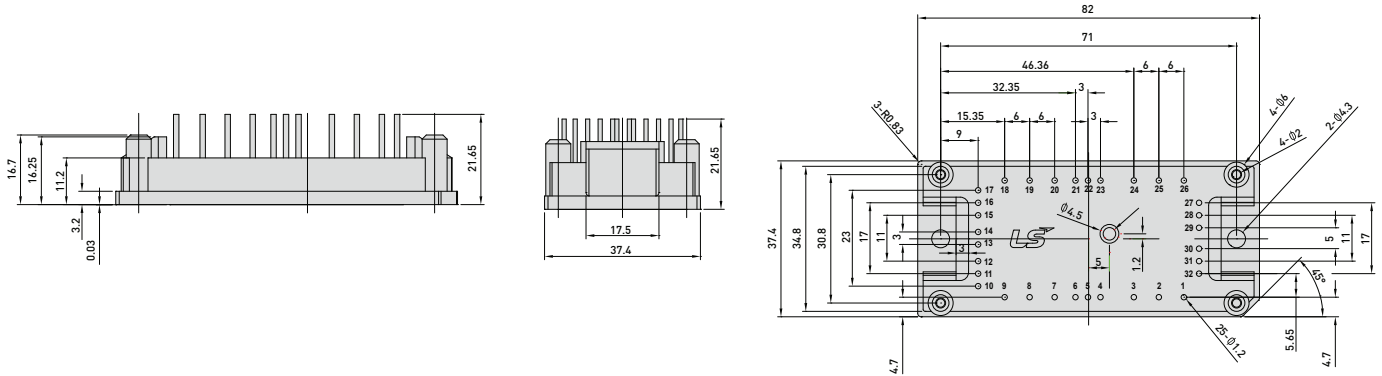

SISPM1 6PACK MOSFET

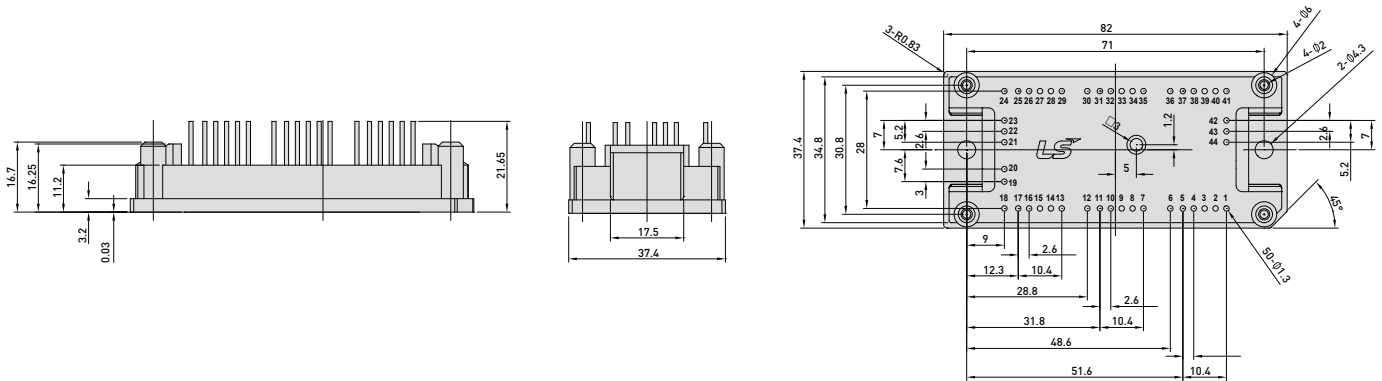

SISPM1 6PACK IGBT

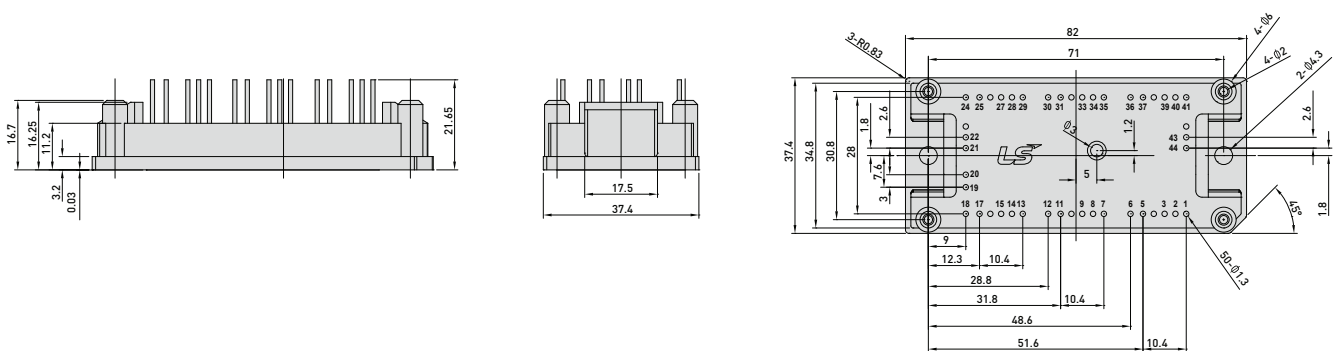

Memo

A large, empty rectangular area with rounded corners, intended for taking notes or a memo.



Ordering information

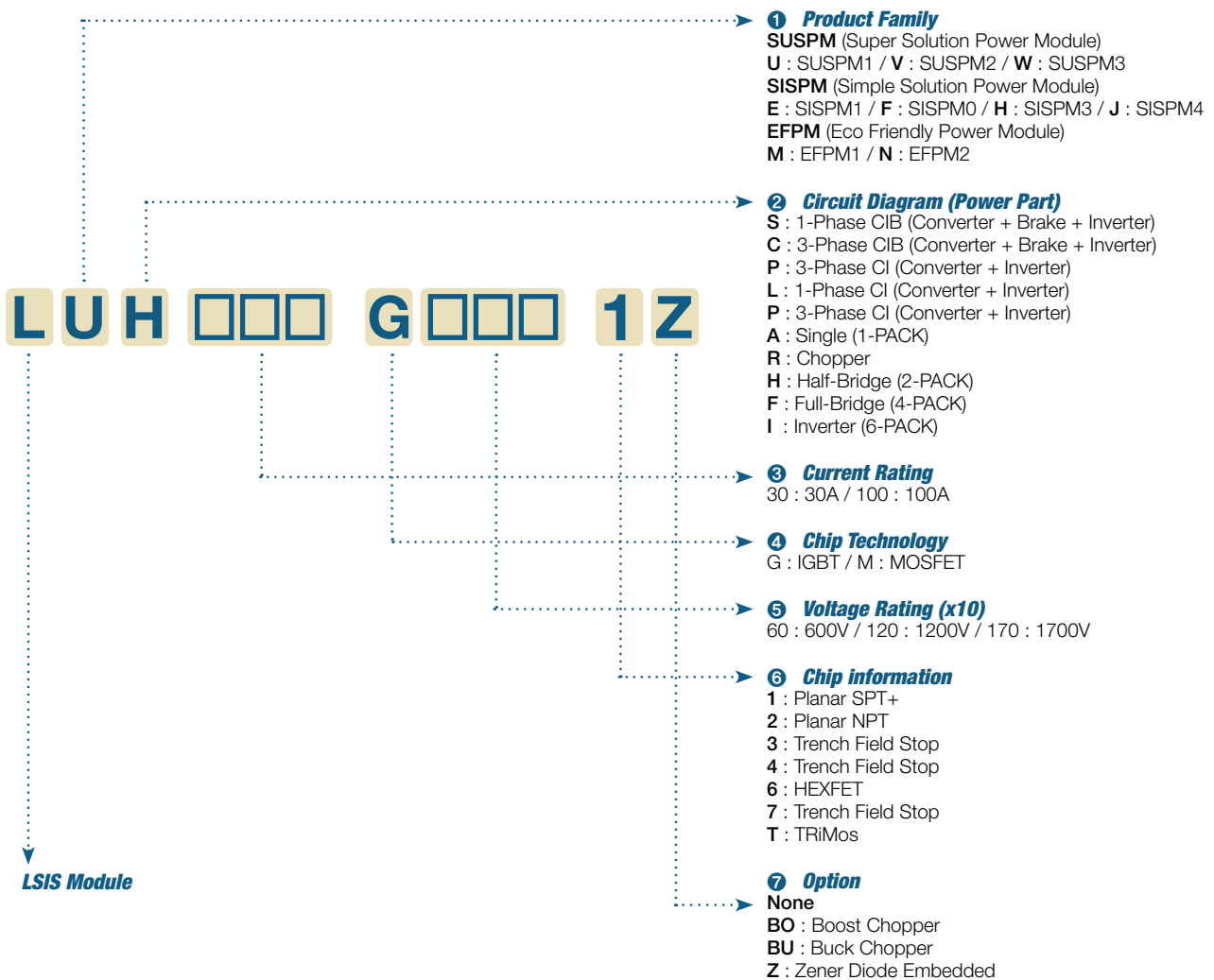



This catalogue was produced using environmentally-friendly paper recommended by environmental organizations.

Green Innovators of Innovation



Safety Instructions

- For your safety, please read user's manual thoroughly before operating.
- Contact the nearest authorized service facility for examination, repair, or adjustment.
- Please contact qualified service technician when you need maintenance. Do not disassemble or repair by yourself!
- Any maintenance and inspection shall be performed by the personnel having expertise concerned.



© 2008. LSIS. All Rights Reserved.

www.lsis.biz

Head Office

LS Tower, 127, LS-ro, Hoggie-dong, Dongan-gu, Anyang-si, Gyeonggi-do, 431-848, Korea
Tel : +82-2-1544-2080 Fax : +82-2-3660-7021

Sales contacts

- Korea (Hyoungnam Kim)
TEL : +82-2-2034-4606 / E-mail : hnkim@lsis.biz
- China / Singapore / Iran / Japan (Philku Kang)
TEL : +82-2-2034-4087 / E-mail : pkang@lsis.biz
- India / America (North & South) (Sunhee Lee)
TEL : +82-2-2034-4457 / E-mail : shleep@lsis.biz
- Europe (Dongrin Han)
TEL : +82-2-2034-4971 / E-mail : dhan@lsis.biz

Marketing contacts

- Hyoungnam Kim
TEL : +82-2-2034-4606 / E-mail : hnkim@lsis.biz

Sales Reps and Distributors

Korea

- SeJong SanJun Co.,Ltd.**
343-7, Gasan-Dong, Geumcheon-Gu, Seoul, Korea, 153-802
Tel : +82 2 6346 0123 / + 82 10 6289 7748 Fax : + 82 6346 1230 Email : sks@sejongsls.co.kr
- KHT (Keumho Technology)**
Rm, A-408, Techno Plaza, Jeonpo1-dong, Busanjin-gu, Busan, Korea
Tel : +82 51 818 0098 Fax : +82 51 818 0028 Email : keumho@keumhocorp.com
- MyungSung Semitech**
379, 3Fl, Jihoon building, 3464-39, Seocho-dong, Seocho-gu, Seoul, Korea
Tel : +82 2 3474 3220 Fax : +82 2 3474 3266 Email : chung1574@naver.com
- San Tech Korea**
#3203, Changshin College, 1 Hapsung2-dong, Masan city, Gyeongnam, Korea
Tel : +82 55 253 7203 Fax : +82 55 250 1393 Email : jpleehic@naver.com

China

- 易達電子有限公司(Edal Electronics Co.,Ltd)**
Jay-He (PM)_ 中国深圳市 深南大道6015号本原大厦18A
Tel : +86-13500052092 Email : jayhe@edal.com.hk www.edal.com.hk
- 深圳中鹏科技有限公司(Shenzhen Bright Future Technology Co.,Ltd)**
William Wu (CEO)_ 中国深圳市 福田区泰然4路雪松大厦A座7A
Tel : +86-13632897810 Email : lliam@szzhongpeng.com www.szzhongpeng.com
- 晴翔电子科技有限公司(Sun-Fly Electronics Technology Ltd)**
Rocky Zhang (CEO)_ 中国深圳市 南山区深南大道10128号 南山软件园东塔608室
Tel : +86-13502898396 Email : rocky.zhang@sunflyhk.com www.sun-fly.com.cn
- 汇贤科技有限公司(Wiseworld Power Ltd.)**
Terence Chan (PM)_ 中国深圳市 福田中心区福华三路168号 深圳国际商会中心24楼2408室
Tel : +86-13556811475 terence.chan@wiseworldpower.com www.wiseworldpower.com
- 杭州控释科技有限公司(Hangzhou Conease Technology Co.,Ltd)**
Pei Zheng Wei (CEO)_ 中国杭州江干区天城路176号白云大厦1幢2001室
Tel : +86-15306589109 Fax : +86-18868719137 Email : wxpz@yaho.com.cn

France

Eurocomposant
1, rue René Caudron, F-78960 Voisins Le Bretonneux
Tel : +33 (0)1 30 64 95 15 E-mail : contact@eurocomposant.fr

Germany, Italy, Switeland, Denmark, Austria, Belgium, Netherland

MSC Vertriebs GmbH
Industriestr. 16 , 76297 Stutensee, Germany
Tel : +49 7249 910 129 Fax : +49 7249 910 216 E-mail : power-devices@msc-ge.com

Germany, Sweden, Norway, Denmark, Finland, Baltic countries, Italy

R3Tec GmbH
Körnerstrasse 9, 55120 Mainz, Germany
Tel +49 (0) 6131/885 98 03 E-mail info@r3tec.de

India

- Rectifier House (India) Pvt.Limited**
Shop No. 5, 'A' wing, Vora Plaza, Navghar, Vasai Rd. (E), Dist. Thane - 401 202, India
Tel : +91 22 2387 6249 E-mail : rectifier@vsnl.com
- Millennium Semiconductors**
17/18/19, 2nd Floor, Mahalaxmi Heights, Mumbai-Pune Road, Pimpri, Pune 411 018, Maharashtra, India.
Tel : +91-20 2748 4800, 2748 4900 / 2748 4500 E-mail : millenniumsemi@vsnl.net

Iran

Eamen Tablo Eng Co.
No2. 4th Alley, Sabouchi Street, Bheshti Ave, Tehran, Iran
Tel : +98 21 8876 8001 Fax : +98 21 88768655 E-mail : info@eamentablo.com

Singapore, Philippines, Indonesia, Thailand

Fuji-Shanhong Power Solutions Pte Ltd
169 Kaki Bukit Avenue 1, Shun Li Industrial Park, #03-00, Singapore 416019
Tel : +65 6745 8343 Email : info@fuji-shanhong.com

Spain

Rectificadores Guasch, S.A.
Ciutat de Granada,80, 08005 Barcelona, Spain
Tel : +34 93 309 8891 E-mail : guasch@e-guasch.com

UK

- Neutron Ltd**
Unit T3, Delta House, Fircroft Way, Edenbridge, Kent TN8 6EL, UK
Tel : +44 1732 868646 E-mail : chris@neutronltd.co.uk
- Delta Components (Rep)**
Unit T3, Delta House, Fircroft Way, Edenbridge, Kent TN8 6EL, UK
Tel : +44 1732 865435 E-mail : sales@deltacomponents.com

Brazil

Capitolio Semiconductors
Alameda dos Pamaris N°188-Moema São Paulo, SP, Brazil
Tel : +55 11 5090 4500 Email : diogo@capitoliosemic.com.br