



ATmega3209/4809 – 48-pin Data Sheet

megaAVR® 0-series

Introduction

The ATmega3208/3209/4808/4809 microcontrollers of the megaAVR® 0-series are using the AVR® processor with hardware multiplier, running at up to 20 MHz, with a wide range of Flash sizes up to 48 KB, up to 6 KB of SRAM, and 256 bytes of EEPROM in 28-, 32-, or 48-pin package. The series uses the latest technologies from Microchip with a flexible and low-power architecture including Event System and SleepWalking, accurate analog features and advanced peripherals.

The devices described here offer Flash sizes from 32 KB to 48 KB in a 48-pin package.

Features

- AVR® CPU
 - Single-cycle I/O access
 - Two-level interrupt controller
 - Two-cycle hardware multiplier
- Memories
 - Up to 48 KB In-system self-programmable Flash memory
 - 256B EEPROM
 - Up to 6 KB SRAM
 - Write/Erase endurance:
 - Flash 10,000 cycles
 - EEPROM 100,000 cycles
 - Data retention: 20 Years at 85°C
- System
 - Power-on Reset (POR) circuit
 - Brown-out Detection (BOD)
 - Clock options:
 - 20 MHz low power internal oscillator with fuse-protected frequency setting
 - 32.768 kHz Ultra Low Power (ULP) internal oscillator
 - 32.768 kHz external crystal oscillator
 - External clock input
 - Single pin Unified Program Debug Interface (UPDI)
 - Three sleep modes:
 - Idle with all peripherals running and mode for immediate wake-up time
 - Standby
 - Configurable operation of selected peripherals

ATmega3209/4809 – 48-pin Data Sheet

- SleepWalking peripherals
 - Power Down with limited wake-up functionality
- Peripherals
 - One 16-bit Timer/Counter type A with dedicated period register, three compare channels (TCA)
 - Four 16-bit Timer/Counter type B with input capture (TCB)
 - One 16-bit Real Time Counter (RTC) running from external crystal or internal RC oscillator
 - Four USART with fractional baud rate generator, autobaud, and start-of-frame detection
 - Master/slave Serial Peripheral Interface (SPI)
 - Dual mode Master/Slave TWI with dual address match
 - Standard mode (Sm, 100 kHz)
 - Fast mode (Fm, 400 kHz)
 - Fast mode plus (Fm+, 1 MHz)
 - Event System for CPU independent and predictable inter-peripheral signaling
 - Configurable Custom Logic (CCL) with up to four programmable Lookup Tables (LUT)
 - One Analog Comparator (AC) with scalable reference input
 - One 10-bit 150 ksps Analog to Digital Converter (ADC)
 - Five selectable internal voltage references: 0.55V, 1.1V, 1.5V, 2.5V, and 4.3V
 - CRC code memory scan hardware
 - Optional automatic scan after reset
 - Watchdog Timer (WDT) with Window Mode, with separate on-chip oscillator
 - External interrupt on all general purpose pins
- I/O and Packages:
 - 41 programmable I/O lines
 - 48-pin UQFN 6x6 and TQFP 7x7
- Temperature Range: -40°C to 125°C
- Speed Grades:
 - 0-5 MHz @ 1.8V – 5.5V
 - 0-10 MHz @ 2.7V – 5.5V
 - 0-20 MHz @ 4.5V – 5.5V, -40°C to 105°C

Table of Contents

Introduction.....	1
Features.....	1
1. Ordering Information.....	5
2. Block Diagram.....	6
3. Pinout.....	7
3.1. 48-pin QFN/TQFP.....	7
4. I/O Multiplexing and Considerations.....	8
4.1. Multiplexed Signals.....	8
5. Electrical Characteristics.....	10
5.1. Absolute Maximum Ratings	10
5.2. General Operating Ratings	10
5.3. Power Considerations.....	11
5.4. Power Consumption.....	12
5.5. Peripherals Power Consumption.....	13
5.6. BOD and POR Characteristics.....	14
5.7. External Reset Characteristics.....	15
5.8. Oscillators and Clocks.....	15
5.9. I/O Pin Characteristics.....	18
5.10. VREF.....	19
5.11. ADC.....	20
5.12. AC.....	23
5.13. UPDI Timing.....	24
6. Typical Characteristics.....	25
6.1. Power Consumption.....	25
6.2. GPIO.....	33
6.3. VREF Characteristics.....	40
6.4. BOD Characteristics.....	42
6.5. ADC Characteristics.....	45
6.6. AC Characteristics.....	55
6.7. OSC20M Characteristics.....	57
6.8. OSCULP32K Characteristics.....	59
7. Package Drawings.....	61
7.1. 48 pin TQFP.....	61
8. Conventions.....	63
8.1. Memory Size and Type.....	63
8.2. Frequency and Time.....	63

ATmega3209/4809 – 48-pin Data Sheet

9. Data Sheet Revision History.....	64
9.1. Rev. A - 02/2018.....	64
The Microchip Web Site.....	65
Customer Change Notification Service.....	65
Customer Support.....	65
Product Identification System.....	66
Microchip Devices Code Protection Feature.....	66
Legal Notice.....	66
Trademarks.....	67
Quality Management System Certified by DNV.....	67
Worldwide Sales and Service.....	68

1. Ordering Information

Find available ordering options online at microchipdirect.com, or contact your local sales representative.

2. Block Diagram

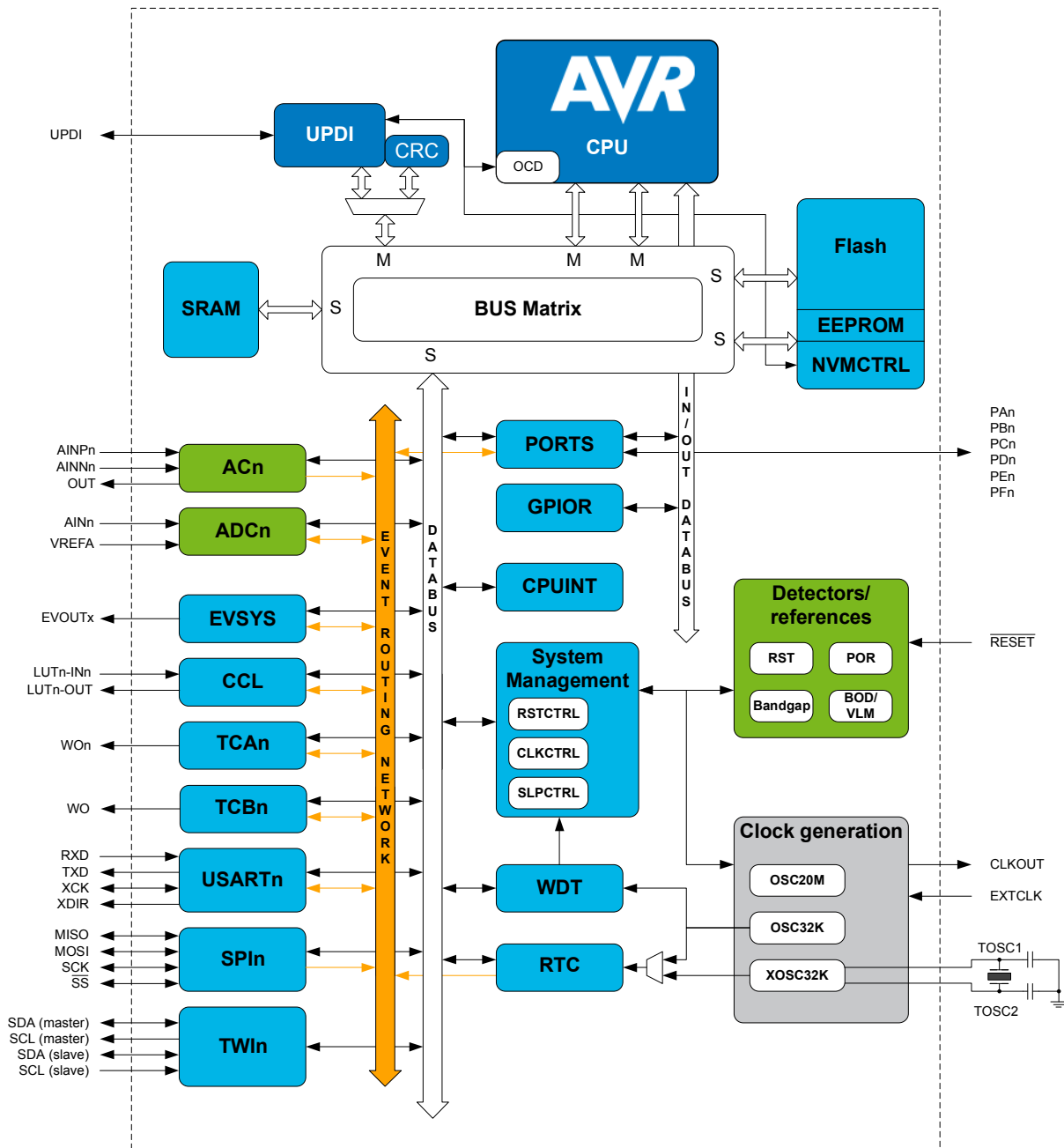

3. Pinout

3.1 48-pin QFN/TQFP

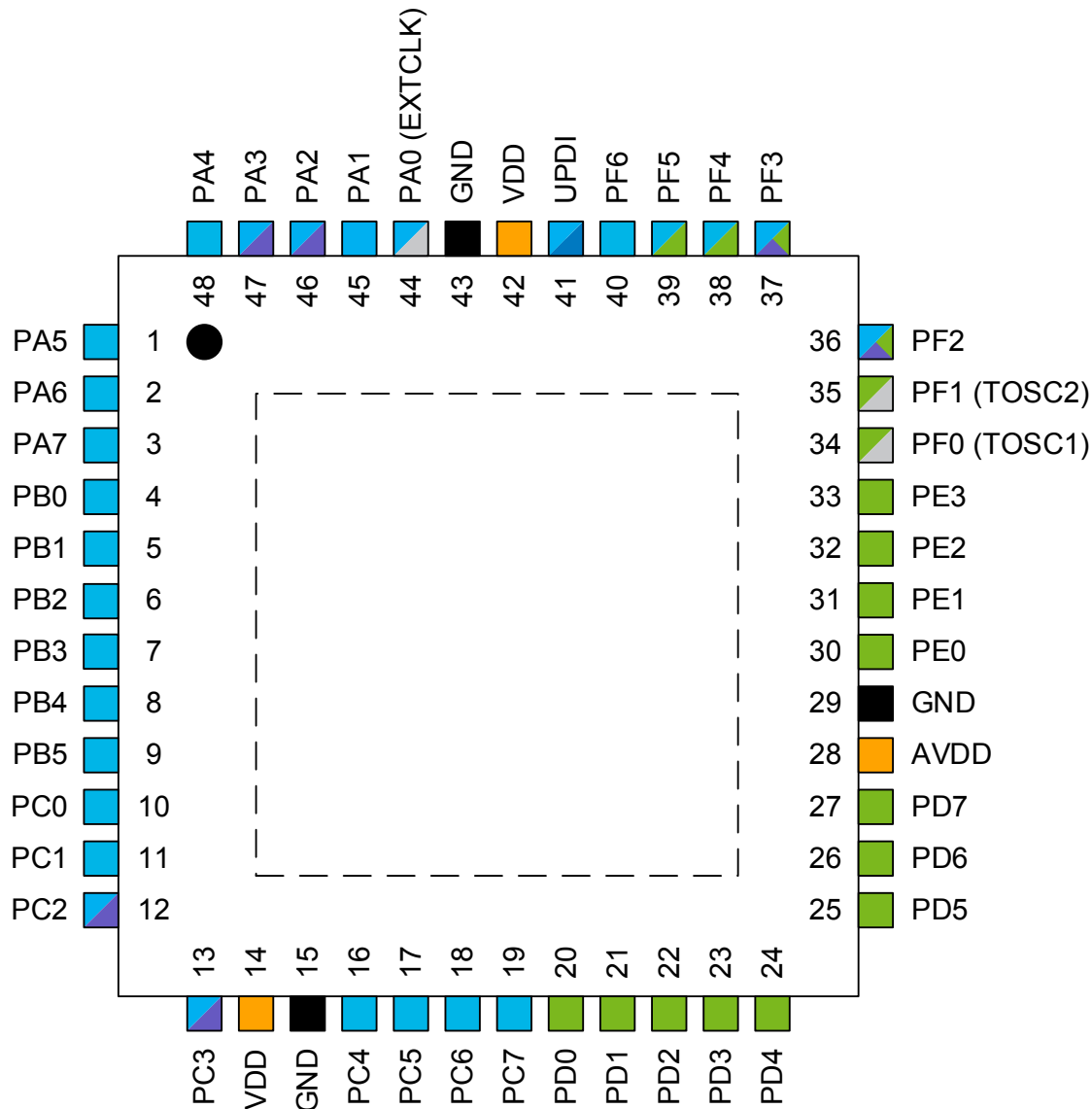

Power

- Input supply
- Ground
- GPIO on VDD power domain
- GPIO on AVDD power domain

Functionality

- Programming, debug
- Clock, crystal
- TWI
- Digital functions only
- Analog functions

ATmega3209/4809 – 48-pin Data Sheet

I/O Multiplexing and Considerations

4. I/O Multiplexing and Considerations

4.1 Multiplexed Signals

QFN48/ TQFP48	Pin name ^(1,2)	Special	ADC0	AC0	USARTn	SPI0	TWI0	TCA0	TCBn	Other	CCL-LUTn
44	PA0	EXTCLK			0,TxD			0-W00			0-IN0
45	PA1				0,RxD			0-W01			0-IN1
46	PA2	TWI			0,XCK		SDA(MS)	0-W02	0-W0	EVOUTA	0-IN2
47	PA3	TWI			0,XDIR		SCL(MS)	0-W03	1-W0		0-OUT
48	PA4				0,TxD ⁽³⁾	MOSI		0-W04			
1	PA5				0,RxD ⁽³⁾	MISO		0-W05			
2	PA6				0,XCK ⁽³⁾	SCK					0-OUT ⁽³⁾
3	PA7	CLKOUT		OUT	0,XDIR ⁽³⁾	SS				EVOUTA ⁽³⁾	
4	PB0				3,TxD			0-W00 ⁽³⁾			
5	PB1				3,RxD			0-W01 ⁽³⁾			
6	PB2				3,XCK			0-W02 ⁽³⁾		EVOUtb	
7	PB3				3,XDIR			0-W03 ⁽³⁾			
8	PB4				3,TxD ⁽³⁾			0-W04 ⁽³⁾	2-W0 ⁽³⁾		
9	PB5				3,RxD ⁽³⁾			0-W05 ⁽³⁾	3-W0		
10	PC0				1,TxD	MOSI ⁽³⁾		0-W00 ⁽³⁾	2-W0		1-IN0
11	PC1				1,RxD	MISO ⁽³⁾		0-W01 ⁽³⁾	3-W0 ⁽³⁾		1-IN1
12	PC2	TWI			1,XCK	SCK ⁽³⁾	SDA(MS) ⁽³⁾	0-W02 ⁽³⁾		EVOUtc	1-IN2
13	PC3	TWI			1,XDIR	SS ⁽³⁾	SCL(MS) ⁽³⁾	0-W03 ⁽³⁾			1-OUT
14	VDD										
15	GND										
16	PC4				1,TxD ⁽³⁾			0-W04 ⁽³⁾			
17	PC5				1,RxD ⁽³⁾			0-W05 ⁽³⁾			
18	PC6				1,XCK ⁽³⁾						1-OUT ⁽³⁾
19	PC7				1,XDIR ⁽³⁾					EVOUtc ⁽³⁾	
20	PD0		AIN0					0-W00 ⁽³⁾			2-IN0
21	PD1		AIN1	P3				0-W01 ⁽³⁾			2-IN1
22	PD2		AIN2	P0				0-W02 ⁽³⁾		EVOUtd	2-IN2
23	PD3		AIN3	N0				0-W03 ⁽³⁾			2-OUT
24	PD4		AIN4	P1				0-W04 ⁽³⁾			
25	PD5		AIN5	N1				0-W05 ⁽³⁾			
26	PD6		AIN6	P2							2-OUT ⁽³⁾
27	PD7	VREFA	AIN7	N2						EVOUtd ⁽³⁾	
28	AVDD										
29	GND										
30	PE0		AIN8			MOSI ⁽³⁾		0-W00 ⁽³⁾			
31	PE1		AIN9			MISO ⁽³⁾		0-W01 ⁽³⁾			
32	PE2		AIN10			SCK ⁽³⁾		0-W02 ⁽³⁾		EVOUte	
33	PE3		AIN11			SS ⁽³⁾		0-W03 ⁽³⁾			
34	PF0	TOSC1			2,TxD			0-W00 ⁽³⁾			3-IN0
35	PF1	TOSC2			2,RxD			0-W01 ⁽³⁾			3-IN1
36	PF2	TWI	AIN12		2,XCK		SDA(S) ⁽³⁾	0-W02 ⁽³⁾		EVOUtf	3-IN2
37	PF3	TWI	AIN13		2,XDIR		SCL(S) ⁽³⁾	0-W03 ⁽³⁾			3-OUT

ATmega3209/4809 – 48-pin Data Sheet

I/O Multiplexing and Considerations

QFN48/ TQFP48	Pin name ^(1,2)	Special	ADC0	AC0	USARTn	SPI0	TWI0	TCA0	TCBn	Other	CCL-LUTn
38	PF4		AIN14		2,TxD ⁽³⁾			0-WO4 ⁽³⁾	0-WO ⁽³⁾		
39	PF5		AIN15		2,RxD ⁽³⁾			0-WO5 ⁽³⁾	1-WO ⁽³⁾		
40	PF6	RESET			2,XCK ⁽³⁾						3-OUT ⁽³⁾
41	UPDI										
42	VDD										
43	GND										

Note:

1. Pin names are of type Pxn, with x being the PORT instance (A,B,C, ...) and n the pin number. Notation for signals is PORTx_PINn. All pins can be used as event input.
2. All pins can be used for external interrupt, where pins Px2 and Px6 of each port have full asynchronous detection.
3. Alternate pin positions. For selecting the alternate positions, refer to the PORTMUX documentation.

5. Electrical Characteristics

5.1 Absolute Maximum Ratings

Stresses beyond those listed in this section may cause permanent damage to the device. This is a stress rating only and functional operation of the device at these or other conditions beyond those indicated in the operational sections of this specification is not implied. Exposure to absolute maximum rating conditions for extended periods may affect device reliability.

Table 5-1. Absolute Maximum Ratings

Symbol	Description	Conditions	Min.	Max.	Unit
V _{DD}	Power Supply Voltage		-0.5	6	V
I _{VDD}	Current into a V _{DD} pin	T _A =[-40, 85]°C	-	200	mA
		T _A =[85, 125]°C	-	100	mA
I _{GND}	Current out of a GND pin	T _A =[-40, 85]°C	-	200	mA
		T _A =[85, 125]°C	-	100	mA
V _{PIN}	Pin voltage with respect to GND		-0.5	V _{DD} +0.5	V
I _{PIN}	I/O pin sink/source current		-40	40	mA
I _{C1} ⁽¹⁾	I/O pin injection current except for the RESET pin	V _{pin} <GND-0.6V or 5.5V<V _{pin} ≤6.1V 4.9V<V _{DD} ≤5.5V	-1	1	mA
I _{C2} ⁽¹⁾	I/O pin injection current except for the RESET pin	V _{pin} <GND-0.6V or V _{pin} ≤5.5V V _{DD} ≤4.9V	-15	15	mA
T _{storage}	Storage temperature		-65	150	°C

Note:

- If V_{PIN} is lower than GND-0.6V, then a current limiting resistor is required. The negative DC injection current limiting resistor is calculated as $R = (GND-0.6V - V_{pin})/I_{Cn}$.
 - If V_{PIN} is greater than V_{DD}+0.6V, then a current limiting resistor is required. The positive DC injection current limiting resistor is calculated as $R = (V_{pin}-(V_{DD}+0.6V))/I_{Cn}$.

5.2 General Operating Ratings

The device must operate within the ratings listed in this section in order for all other electrical characteristics and typical characteristics of the device to be valid.

Table 5-2. General Operating Conditions

Symbol	Description	Condition	Min.	Max.	Unit
V _{DD}	Operating Supply Voltage		1.8 ⁽¹⁾	5.5	V
T _A	Operating temperature range	Standard temperature range	-40	125	°C

Note:

- Operation is guaranteed down to 1.8V or VBOD with BODLEVEL=1.8V, whichever is lower.

ATmega3209/4809 – 48-pin Data Sheet

Electrical Characteristics

Table 5-3. Operating Voltage and Frequency

Symbol	Description	Condition	Min.	Max. ⁽¹⁾	Unit
f _{CLK_CPU}	Nominal operating system clock frequency	V _{DD} =[1.8, 5.5]V T _A =[-40, 105]°C ⁽²⁾	0	5	MHz
		V _{DD} =[2.7, 5.5]V T _A =[-40, 105]°C ⁽³⁾	0	10	
		V _{DD} =[4.5, 5.5]V T _A =[-40, 105]°C ⁽⁴⁾	0	20	
		V _{DD} =[2.7, 5.5]V T _A =[-40, 125]°C ⁽³⁾	0	8	
		V _{DD} =[4.5, 5.5]V T _A =[-40, 125]°C ⁽³⁾	0	16	

Note:

1. Operation is guaranteed 5% above the maximum frequency.
2. Operation is guaranteed down to BOD triggering level, V_{BOD} with BODLEVEL=1.8V.
3. Operation is guaranteed down to BOD triggering level, V_{BOD} with BODLEVEL=2.7V.
4. Operation is guaranteed down to BOD triggering level, V_{BOD} with BODLEVEL=4.3V.

The maximum CPU clock frequency depends on V_{DD}. As shown in the following figure, the Maximum Frequency vs. V_{DD} is linear between 1.8V < V_{DD} < 2.7V and 2.7V < V_{DD} < 4.5V

Figure 5-1. Maximum Frequency vs. V_{DD} for [-40, 105]°C

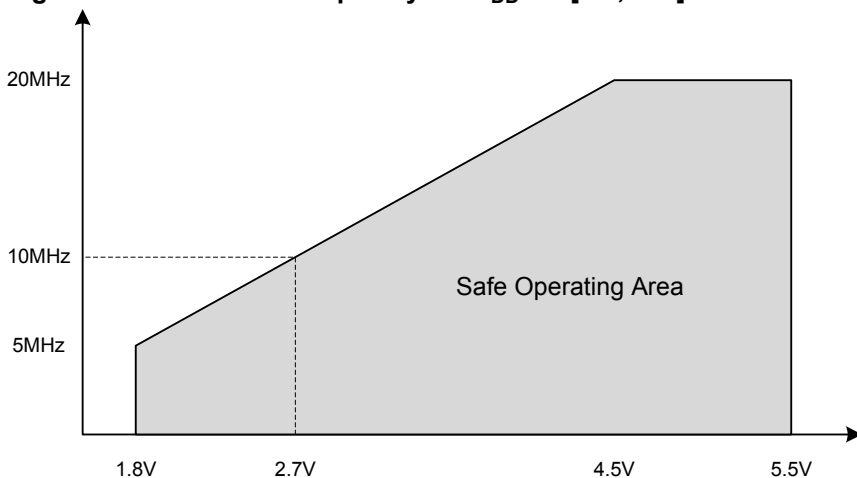

5.3 Power Considerations

The average die junction temperature, T_J (in °C) is given from the formula

$$T_J = T_A + P_D * R_{\theta JA}$$

ATmega3209/4809 – 48-pin Data Sheet

Electrical Characteristics

where P_D is the total power dissipation.

The total thermal resistance of a package ($R_{\theta JA}$) can be separated into two components, $R_{\theta JC}$ and $R_{\theta CA}$, representing the barrier to heat flow from the semiconductor junction to the package (case) surface ($R_{\theta JC}$) and from the case to the outside ambient air ($R_{\theta CA}$). These terms are related by the equation:

$$R_{\theta JA} = R_{\theta JC} + R_{\theta CA}$$

$R_{\theta JC}$ is device related and cannot be influenced by the user. However, $R_{\theta CA}$ is user dependent and can be minimized by thermal management techniques such as heat sinks, ambient air cooling, and thermal convection. Thus, good thermal management on the part of the user can significantly reduce $R_{\theta CA}$ so that $R_{\theta JA}$ approximately equals $R_{\theta JC}$.

The power dissipation curve is negatively sloped as ambient temperature increase. The maximum power dissipation is therefore at minimum ambient temperature while the highest junction temperature occurs at the maximum ambient temperature.

Table 5-4. Power Dissipation and Junction Temperature vs Temperature

Package	T_A Range	$R_{\theta JA}$ ($^{\circ}C/W$)	P_D (W) typical	$T_J - T_A$ ($^{\circ}C$) typical
QFN48	-40 $^{\circ}C$ to 125 $^{\circ}C$		1.0	
TQFP48	-40 $^{\circ}C$ to 125 $^{\circ}C$		1.0	

5.4 Power Consumption

The values are measured power consumption under the following conditions, except where noted:

- $V_{DD}=3V$
- $T_A=25^{\circ}C$
- OSC20M used as system clock source, except where otherwise specified
- System power consumption measured with peripherals disabled and without I/O drive.

Table 5-5. Power Consumption in Active and Idle Mode

Mode	Description	Condition	V_{DD}	Typ.	Max.	Unit
Active	Active power consumption	$f_{CLK_CPU}=20$ MHz (OSC20M)	$V_{DD}=5V$	8.5	-	mA
		$f_{CLK_CPU}=10$ MHz (OSC20M div2)	$V_{DD}=5V$	4.3	-	mA
			$V_{DD}=3V$	2.3	-	mA
			$V_{DD}=2V$	0.75	-	mA
		$f_{CLK_CPU}=5$ MHz (OSC20M div4)	$V_{DD}=5V$	2.15	-	mA
			$V_{DD}=3V$	1.2	-	mA
			$V_{DD}=2V$	0.75	-	mA
		$f_{CLK_CPU}=32$ KHz (OSCULP32K)	$V_{DD}=5V$	16.4	-	μA
			$V_{DD}=3V$	9.0	-	μA
$V_{DD}=2V$	6.0		-	μA		
Idle	Idle power consumption	$f_{CLK_CPU}=20$ MHz (OSC20M)	$V_{DD}=5V$	2.8	-	mA
		$f_{CLK_CPU}=10$ MHz (OSC20M div2)	$V_{DD}=5V$	1.4	-	mA

ATmega3209/4809 – 48-pin Data Sheet

Electrical Characteristics

Mode	Description	Condition	Typ.	Max.	Unit
		$V_{DD}=3V$	0.8	-	mA
		$f_{CLK_CPU}=5\text{ MHz (OSC20M div4)}$	$V_{DD}=5V$ 0.7	-	mA
		$V_{DD}=3V$	0.4	-	mA
		$V_{DD}=2V$	0.25	-	mA
		$f_{CLK_CPU}=32\text{ KHz (OSCULP32K)}$	$V_{DD}=5V$ 5.6	-	μA
		$V_{DD}=3V$	2.8	-	μA
		$V_{DD}=2V$	1.8	-	μA

Table 5-6. Power Consumption in Power-Down, Standby and Reset Mode

Mode	Description	Condition	Typ. 25°C	Max. 85°C	Max. 125°C	Unit
Standby	Standby power consumption	RTC running at 1.024 kHz from external XOSC32K (CL=7.5pF)	$V_{DD}=3V$ 0.69	-	-	μA
		RTC running at 1.024 kHz from internal OSCULP32K	$V_{DD}=3V$ 0.65	TBD	TBD	μA
Power Down/ Standby	Power down/Standby power consumption are the same when all peripherals are stopped	All peripherals stopped	$V_{DD}=3V$ 0.10	TBD	TBD	μA
Reset	Reset power consumption	RESET line pulled low	$V_{DD}=3V$ 100	-	-	μA

5.5 Peripherals Power Consumption

The table below can be used to calculate the additional current consumption for the different I/O peripherals in the various operating modes.

Operating conditions:

- $V_{DD}=3V$
- $T=25^{\circ}C$
- OSC20M at 1 MHz used as system clock source, except where otherwise specified.

Table 5-7. Peripherals Power Consumption

Peripheral	Conditions	Typ. ⁽¹⁾	Unit
BOD	Continuous	19	μA
	Sampling @ 1 kHz	1.2	
TCA	16-bit count @ 1 MHz	12.6	μA

ATmega3209/4809 – 48-pin Data Sheet

Electrical Characteristics

Peripheral	Conditions	Typ. ⁽¹⁾	Unit
TCB	16-bit count @ 1 MHz	7.4	μA
RTC	16-bit count @ OSCULP32K	1.2	μA
WDT (including OSCULP32K)		0.7	μA
OSC20M		125	μA
AC	Fast Mode ⁽²⁾	92	μA
	Low Power Mode ⁽²⁾	45	μA
ADC	50 ksps	325	μA
	100 ksps	340	μA
XOSC32K	C _L =7.5 pF	0.5	μA
OSCULP32K		0.4	μA
USART	Enable @ 9600 Baud	13	μA
SPI (Master)	Enable @ 100 kHz	2.1	μA
TWI (Master)	Enable @ 100 kHz	23.9	μA
TWI (Slave)	Enable @ 100 kHz	17.1	μA
Flash programming	Erase Operation	1.5	mA
	Write Operation	3.0	

Note:

1. Current consumption of the module only. To calculate the total power consumption of the system, add this value to the base value in section “Power Consumption”.
2. CPU in Standby mode.

5.6 BOD and POR Characteristics

Table 5-8. Power Supply Characteristics

Symbol	Description	Condition	Min.	Typ.	Max.	Unit
SRON	Power-on Slope		-	-	100	V/ms

Table 5-9. Power On Reset (POR) Characteristics

Symbol	Description	Condition	Min.	Typ.	Max.	Unit
V _{POR}	POR threshold voltage on V _{DD} falling	V _{DD} falls/rises at 0.5V/ms or slower	0.8	-	1.6	V
	POR threshold voltage on V _{DD} rising		1.4	-	1.8	

ATmega3209/4809 – 48-pin Data Sheet

Electrical Characteristics

Table 5-10. Brownout Detection (BOD) Characteristics

Symbol	Description	Condition	Min.	Typ.	Max.	Unit
V _{BOD}	BOD detection level (falling)	BODLEVEL=1.8V	1.71	1.78	1.85	V
		BODLEVEL=2.7V	2.45	2.60	2.75	
		BODLEVEL=4.3V	4.05	4.25	4.45	
V _{HYS}	Hysteresis	BODLEVEL=1.8V	-	25	-	mV
		BODLEVEL=2.7V	-	40	-	
		BODLEVEL=4.3V	-	80	-	
t _{BOD}	Detection time	Continuous	-	7	-	μs
		Sampled, 1 kHz	-	1	-	ms
		Sampled, 125 Hz	-	8	-	
t _{startup}	Start-up time	Time from enable to ready	-	40	-	μs
ΔV _{LVD}	Interrupt level 0	Percentage above the selected BOD level	-	4	-	%
	Interrupt level 1		-	13	-	
	Interrupt level 2		-	25	-	

5.7 External Reset Characteristics

Table 5-11. External Reset Characteristics

Mode	Description	Condition	Min.	Typ.	Max.	Unit
V _{VIH_RST}	Input Voltage for $\overline{\text{RESET}}$		0.7×V _{DD}	-	V _{DD} +0.2	V
V _{VIL_RST}	Input Low Voltage for $\overline{\text{RESET}}$		-0.2	-	0.3×V _{DD}	
t _{MIN_RST}	Minimum pulse width on $\overline{\text{RESET}}$ pin		300	-	-	ns
R _{p_RST}	$\overline{\text{RESET}}$ pull-up resistor	V _{Reset} =0V	20	35	50	kΩ

5.8 Oscillators and Clocks

Operating conditions:

- V_{DD}=3V, except where specified otherwise.

Table 5-12. 20 MHz Internal Oscillator (OSC20M) Characteristics

Symbol	Description	Condition	Min.	Typ.	Max.	Unit	
f _{OSC20M}	Factory calibration frequency	FREQSEL=0	T _A =25°C, 3.0V		16		MHz
		FREQSEL=1			20		
f _{CAL}	Frequency calibration range	OSC16M ⁽²⁾		14.5	17.5	MHz	
		OSC20M ⁽²⁾		18.5	21.5	MHz	

ATmega3209/4809 – 48-pin Data Sheet

Electrical Characteristics

Symbol	Description	Condition	Min.	Typ.	Max.	Unit	
	Factory calibration accuracy		$T_A=25^{\circ}\text{C}$, 3.0V	TBD	± 0.75	TBD	%
E_{TOTAL}	Total error with 16 MHz frequency selection	From target frequency	$T_A=[0, 70]^{\circ}\text{C}$, $V_{\text{DD}}=[1.8, 3.6]\text{V}$	TBD	± 2	TBD	%
			Full operation range	TBD	± 3	TBD	
	Total error with 20 MHz frequency selection	From target frequency	$T_A=[0, 70]^{\circ}\text{C}$, $V_{\text{DD}}=[1.8, 3.6]\text{V}$	TBD	± 2	TBD	
			Full operation range	TBD	± 3	TBD	
E_{DRIFT}	Accuracy with 16 MHz Frequency Selection relative to the factory-stored frequency value	Factory calibrated $V_{\text{DD}}=3\text{V}^{(1)}$	$T_A=[0, 70]^{\circ}\text{C}$, $V_{\text{DD}}=[1.8, 5.5]\text{V}$	TBD	± 1.5	TBD	%
	Accuracy with 20 MHz Frequency Selection relative to the factory-stored frequency value	Factory calibrated $V_{\text{DD}}=3\text{V}^{(1)}$	$T_A=[0, 70]^{\circ}\text{C}$, $V_{\text{DD}}=[1.8, 5.5]\text{V}$	TBD	± 1.5	TBD	
Δf_{OSC20M}	Calibration step size			-	0.75	-	%
D_{OSC20M}	Duty cycle			-	50	-	%
t_{startup}	Start-up time	Within 2% accuracy		-	12	-	μs

Note:

1. See also the description of OSC20M on calibration.
2. Oscillator Frequencies above speed specification must be divided so that CPU clock always is within specification.

Table 5-13. 32.768 kHz Internal Oscillator (OSCULP32K) Characteristics

Symbol	Description	Condition	Condition	Min.	Typ.	Max.	Unit
$f_{\text{OSCULP32K}}$	Factory calibration frequency				32.768		kHz
	Factory calibration accuracy		$T_A=25^{\circ}\text{C}$, 3.0V	-3	± 2	3	%
E_{TOTAL}	Total error from target frequency	Factory calibrated	$T_A=[0, 70]^{\circ}\text{C}$, $V_{\text{DD}}=[1.8, 3.6]\text{V}$	-10	± 5	+10	%
			Full operation range	-30	± 10	+30	
$D_{\text{OSCULP32K}}$	Duty cycle				50		%
t_{startup}	Start-up time			-	250	-	μs

ATmega3209/4809 – 48-pin Data Sheet

Electrical Characteristics

Table 5-14. 32.768 kHz External Crystal Oscillator (XOSC32K) Characteristics

Symbol	Description	Condition	Min.	Typ.	Max.	Unit
f_{out}	Frequency		-	32.768	-	kHz
$t_{startup}$	Startup time	$C_L=7.5$ pF	-	300	-	ms
		$C_L=12.5$ pF	-	TBD	-	
C_L	Crystal load capacitance		7.5	-	12.5	pF
C_{TOSC1}	Parasitic capacitor load		-	5.5	-	pF
C_{TOSC2}			-	5.5	-	pF
ESR	Equivalent Series Resistance - Safety Factor=3	$C_L=7.5$ pF	-	-	80	k Ω
		$C_L=12.5$ pF	-	-	40	

Figure 5-2. External Clock Waveform Characteristics

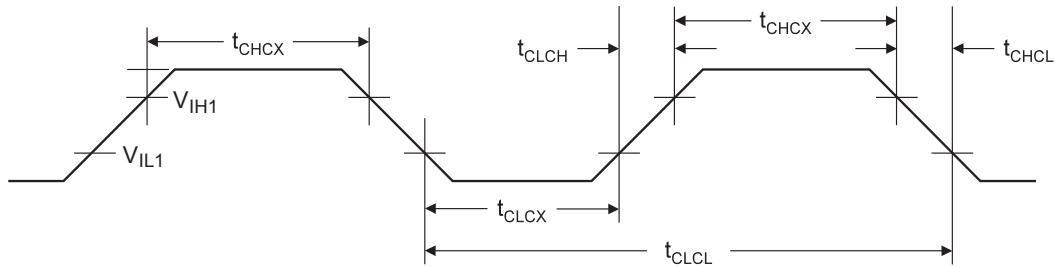

Table 5-15. External Clock Characteristics

Symbol	Description	Condition	$V_{DD}=[1.8, 5.5]$ V		$V_{DD}=[2.7, 5.5]$ V		Unit		
			Min.	Max.	Min.	Max.		Min.	Max.
f_{CLCL}	Frequency		0	5.0	0.0	10.0	0.0	20.0	MHz
t_{CLCL}	Clock Period		200	-	100	-	50	-	ns
t_{CHCX}	High Time		80	-	40	-	20	-	ns
t_{CLCX}	Low Time		80	-	40	-	20	-	ns
t_{CLCH}	Rise Time (for maximum frequency)		-	40	-	20	-	10	ns
t_{CHCL}	Fall Time (for maximum frequency)		-	40	-	20	-	10	ns
Δt_{CLCL}	Change in period from one clock cycle to the next		-	20	-	20	-	20	%

ATmega3209/4809 – 48-pin Data Sheet

Electrical Characteristics

5.9 I/O Pin Characteristics

Table 5-16. I/O Pin Characteristics ($T_A=[-40, 85]^{\circ}\text{C}$, $V_{DD}=[1.8, 5.5]\text{V}$ unless otherwise noted)

Symbol	Description	Condition	Min.	Typ.	Max.	Unit
V_{IL}	Input Low Voltage		-0.2	-	$0.3 \times V_{DD}$	V
V_{IH}	Input High Voltage		$0.7 \times V_{DD}$	-	$V_{DD} + 0.2\text{V}$	V
I_{IH} / I_{IL}	I/O pin Input Leakage Current	$V_{DD}=5.5\text{V}$, Pin high	-	< 0.05	-	μA
		$V_{DD}=5.5\text{V}$, Pin low	-	< 0.05	-	
V_{OL}	I/O pin drive strength	$V_{DD}=1.8\text{V}$, $I_{OL}=1.5\text{ mA}$	-	-	0.36	V
		$V_{DD}=3.0\text{V}$, $I_{OL}=7.5\text{ mA}$	-	-	0.6	
		$V_{DD}=5.0\text{V}$, $I_{OL}=15\text{ mA}$	-	-	1	
V_{OH}	I/O pin drive strength	$V_{DD}=1.8\text{V}$, $I_{OH}=1.5\text{ mA}$	1.44	-	-	V
		$V_{DD}=3.0\text{V}$, $I_{OH}=7.5\text{ mA}$	2.4	-	-	
		$V_{DD}=5.0\text{V}$, $I_{OH}=15\text{ mA}$	4	-	-	
I_{total}	Maximum combined I/O sink/ source current per pin group ⁽¹⁾		-	-	100	mA
	Maximum combined I/O sink/ source current per pin group ⁽¹⁾	$T_A=25^{\circ}\text{C}$	-	-	200	
t_{RISE}	Rise time	$V_{DD}=3.0\text{V}$, load=20 pF	-	2.5	-	ns
		$V_{DD}=5.0\text{V}$, load=20 pF	-	1.5	-	
		$V_{DD}=3.0\text{V}$, load=20 pF, slew rate enabled	-	19	-	
		$V_{DD}=5.0\text{V}$, load=20 pF, slew rate enabled	-	9	-	
t_{FALL}	Fall time	$V_{DD}=3.0\text{V}$, load=20 pF	-	2.0	-	ns
		$V_{DD}=5.0\text{V}$, load=20 pF	-	1.3	-	
		$V_{DD}=3.0\text{V}$, load=20 pF, slew rate enabled	-	21	-	
		$V_{DD}=5.0\text{V}$, load=20 pF, slew rate enabled	-	11	-	
C_{pin}	I/O pin capacitance except for TOSC, VREFA, and TWI pins		-	3.5	-	pF
C_{pin}	I/O pin capacitance on TOSC pins		-	4	-	pF
C_{pin}	I/O pin capacitance on TWI pins		-	10	-	pF
C_{pin}	I/O pin capacitance on VREFA pin		-	14	-	pF
R_p	Pull-up resistor		20	35	50	k Ω

ATmega3209/4809 – 48-pin Data Sheet

Electrical Characteristics

Note:

- Pin group A (PA[7:0]), PF[6:2]), pin group B (PB[7:0], PC[7:0]), pin group C (PD:7:0, PE[3:0], PF[1:0]). For 28-pin and 32-pin devices pin group A and B should be seen as a single group. The combined continuous sink/source current for each individual group should not exceed the limits.

5.10 VREF

Table 5-17. Internal Voltage Reference Characteristics

Symbol	Description	Min.	Typ.	Max.	Unit
t_{start}	Start-up time	-	25	-	μ s
$V_{DDINT055V}$	Power supply voltage range for INT055V	1.8	-	5.5	V
$V_{DDINT11V}$	Power supply voltage range for INT11V	1.8	-	5.5	
$V_{DDINT15V}$	Power supply voltage range for INT15V	1.8	-	5.5	
$V_{DDINT25V}$	Power supply voltage range for INT25V	3.0	-	5.5	
$V_{DDINT43V}$	Power supply voltage range for INT43V	4.8	-	5.5	

Table 5-18. ADC Internal Voltage Reference Characteristics⁽¹⁾

Symbol ⁽²⁾	Description	Condition	Min.	Typ.	Max.	Unit
INT11V	Internal reference voltage	$V_{DD}=[1.8V, 3.6V]$ $T=[0 - 105]^{\circ}C$	-2.0		2.0	%
INT055V INT15V INT25V	Internal reference voltage	$V_{DD}=[1.8V, 3.6V]$ $T=[0 - 105]^{\circ}C$	-3.0		3.0	
INT055V INT11V INT15V INT25V INT43V	Internal reference voltage	$V_{DD}=[1.8V, 5.5V]$ $T=[-40 - 125]^{\circ}C$	-5.0		5.0	

Note:

- These values are based on characterization and not covered by production test limits.
- The symbols INTxxV refer to the respective values of the ADC0REFSEL bit field in the VREF.CTRLA register.

Table 5-19. AC Internal Voltage Reference Characteristics⁽¹⁾

Symbol ⁽²⁾	Description	Condition	Min.	Typ.	Max.	Unit
INT055V INT11V	Internal reference voltage	$V_{DD}=[1.8V, 3.6V]$ $T=[0 - 105]^{\circ}C$	-3.0		3.0	%

ATmega3209/4809 – 48-pin Data Sheet

Electrical Characteristics

Symbol ⁽²⁾	Description	Condition	Min.	Typ.	Max.	Unit
INT15V INT25V						
INT055V INT11V INT15V INT25V INT43V	Internal reference voltage	$V_{DD}=[1.8V, 5.5V]$ $T=[-40 - 125]^{\circ}C$	-5.0		5.0	

Note:

1. These values are based on characterization and not covered by production test limits.
2. The symbols INTxxV refer to the respective values of the AC0REFSEL bit field in the VREF.CTRLA register.

5.11 ADC

5.11.1 Internal Reference Characteristics

Operating conditions:

- $V_{DD} = 1.8$ to $5.5V$
- Temperature = $-40^{\circ}C$ to $125^{\circ}C$
- DUTYCYC = 25%
- $CLK_{ADC} = 13 * f_{ADC}$
- SAMPCAP is 10 pF for 0.55V reference, while it is set to 5 pF for $V_{REF} \geq 1.1V$
- Applies for all allowed combinations of V_{REF} selections and Sample Rates unless otherwise noted

Table 5-20. Power Supply, Reference, and Input Range

Symbol	Description	Conditions	Min.	Typ.	Max.	Unit
V_{DD}	Supply voltage	$CLK_{ADC} \leq 1.5$ MHz	1.8	-	5.5	V
		$CLK_{ADC} > 1.5$ MHz	2.7	-	5.5	
V_{REF}	Reference voltage	REFSEL = Internal reference	0.55	-	$V_{DD}-0.5$	V
		REFSEL = External reference	1.1	-	V_{DD}	
		REFSEL = V_{DD}	1.8	-	5.5	
C_{IN}	Input capacitance	SAMPCAP=5 pF	-	5	-	pF
		SAMPCAP=10 pF	-	10	-	
V_{IN}	Input voltage range		0	-	V_{REF}	V
I_{BAND}	Input bandwidth	$1.1V \leq V_{REF}$	-	-	57.5	kHz

ATmega3209/4809 – 48-pin Data Sheet

Electrical Characteristics

Table 5-21. Clock and Timing Characteristics

Symbol	Description	Conditions	Min.	Typ.	Max.	Unit
f_{ADC}	Sample rate	$1.1V \leq V_{REF}$	15	-	115	ksps
		$1.1V \leq V_{REF}$ (8-bit resolution)	15	-	150	
		$V_{REF} = 0.55V$ (10 bits)	7.5	-	20	
CLK_{ADC}	Clock frequency	$V_{REF} = 0.55V$ (10 bits)	100	-	260	kHz
		$1.1V \leq V_{REF}$ (10 bits)	200	-	1500	
		$1.1V \leq V_{REF}$ (8-bit resolution)	200	-	2000	
T_s	Sampling time		2	2	33	CLK_{ADC} cycles
T_{CONV}	Conversion time (latency)	Sampling time = $2 CLK_{ADC}$	8.7	-	50	μs
T_{START}	Start-up time	Internal V_{REF}	-	22	-	μs

Table 5-22. Accuracy Characteristics Internal Reference⁽²⁾

Symbol	Description	Conditions	Min.	Typ.	Max.	Unit	
Res	Resolution		-	10	-	bit	
INL	Integral Non-linearity	REFSEL = INTERNAL $V_{REF} = 0.55V$	$f_{ADC} = 7.7$ ksps	-	1.0	-	LSB
		REFSEL = INTERNAL or VDD	$f_{ADC} = 15$ ksps	-	1.0	-	
		REFSEL = INTERNAL or VDD $1.1V \leq V_{REF}$	$f_{ADC} = 77$ ksps	-	1.0	-	
			$f_{ADC} = 115$ ksps	-	1.2	-	
DNL ⁽¹⁾	Differential Non-linearity	REFSEL = INTERNAL $V_{REF} = 0.55V$	$f_{ADC} = 7.7$ ksps	-	0.6	-	LSB
		REFSEL = INTERNAL $V_{REF} = 1.1V$	$f_{ADC} = 15$ ksps	-	0.4	-	
		REFSEL = INTERNAL or VDD $1.5V \leq V_{REF}$	$f_{ADC} = 15$ ksps	-	0.4	-	
		REFSEL = INTERNAL or VDD $1.1V \leq V_{REF}$	$f_{ADC} = 15$ ksps	-	0.4	-	
			$f_{ADC} = 77$ ksps	-	0.4	-	

ATmega3209/4809 – 48-pin Data Sheet

Electrical Characteristics

Symbol	Description	Conditions	Min.	Typ.	Max.	Unit	
		REFSEL = INTERNAL $1.1V \leq V_{REF}$	$f_{ADC} = 115$ ksps	-	0.5	-	
		REFSEL = VDD $1.8V \leq V_{REF}$	$f_{ADC} = 115$ ksps	-	0.9	-	
EABS	Absolute accuracy	REFSEL = INTERNAL $V_{REF} = 1.1V$	$T = [0-105]^{\circ}C$ $V_{DD} = [1.8V-3.6V]$	-	<10	-	LSB
			$V_{DD} = [1.8V-3.6V]$	-	<15	-	
		REFSEL = VDD		-	2	-	
		REFSEL = INTERNAL		-	<35	-	
EGAIN	Gain error	REFSEL = INTERNAL $V_{REF} = 1.1V$	$T = [0-105]^{\circ}C$ $V_{DD} = [1.8V-3.6V]$	-	± 15	-	LSB
			$V_{DD} = [1.8V-3.6V]$	-	± 20	-	
		REFSEL = VDD		-	2	-	
		REFSEL = INTERNAL		-	± 35	-	
EOFF	Offset error	REFSEL = INTERNAL $V_{REF} = 0.55V$		-	-0.5	-	LSB
		REFSEL = INTERNAL $1.1V \leq V_{REF}$		-	-0.5	-	LSB

Note:

1. A DNL error of less than or equal to 1 LSB ensures a monotonic transfer function with no missing codes.
2. These values are based on characterization and not covered by production test limits.
3. Reference setting and f_{ADC} must fulfill the specification in "Clock and Timing Characteristics" and "Power supply, Reference, and Input Range" tables.

5.11.2 External Reference Characteristics

Operating conditions:

- $V_{DD} = 1.8$ to $5.5V$
- Temperature = $-40^{\circ}C$ to $125^{\circ}C$
- DUTYCYC = 25%
- $CLK_{ADC} = 13 * f_{ADC}$
- SAMPCAP is 5 pF

ATmega3209/4809 – 48-pin Data Sheet

Electrical Characteristics

The accuracy characteristics numbers are based on characterization of the following input reference levels and V_{DD} ranges:

- $V_{ref} = 1.8\text{ V}$, $V_{DD} = 1.8\text{ to }5.5\text{ V}$
- $V_{ref} = 2.6\text{ V}$, $V_{DD} = 2.7\text{ to }5.5\text{ V}$
- $V_{ref} = 4.096\text{ V}$, $V_{DD} = 4.5\text{ to }5.5\text{ V}$
- $V_{ref} = 4.3\text{ V}$, $V_{DD} = 4.5\text{ to }5.5\text{ V}$

Table 5-23. Accuracy Characteristics External Reference⁽²⁾

Symbol	Description	Conditions	Min.	Typ.	Max.	Unit
Res	Resolution		-	10	-	bit
INL	Integral Non-linearity	$f_{ADC}=15\text{ ksps}$	-	0.9	-	LSB
		$f_{ADC}=77\text{ ksps}$	-	0.9	-	
		$f_{ADC}=115\text{ ksps}$	-	1.2	-	
DNL ⁽¹⁾	Differential Non-linearity	$f_{ADC}=15\text{ ksps}$	-	0.2	-	LSB
		$f_{ADC}=77\text{ ksps}$	-	0.4	-	
		$f_{ADC}=115\text{ ksps}$	-	0.8	-	
EABS	Absolute accuracy	$f_{ADC}=15\text{ ksps}$	-	2	-	LSB
		$f_{ADC}=77\text{ ksps}$	-	2	-	
		$f_{ADC}=115\text{ ksps}$	-	2	-	
EGAIN	Gain error	$f_{ADC}=15\text{ ksps}$	-	2	-	LSB
		$f_{ADC}=77\text{ ksps}$	-	2	-	
		$f_{ADC}=115\text{ ksps}$	-	2	-	
E0FF	Offset error		-	-0.5	-	LSB

Note:

1. A DNL error of less than or equal to 1 LSB ensures a monotonic transfer function with no missing codes.
2. These values are based on characterization and not covered by production test limits.

5.12 AC

Table 5-24. Analog Comparator Characteristics

Symbol	Description	Condition	Min.	Typ.	Max.	Unit
V_{IN}	Input Voltage	Low Power Mode	-0.2	-	V_{DD}	V
		High speed mode	-0.2	-	V_{DD}	
C_{IN}	Input Pin Capacitance	PD1 to PD6	-	3.5	-	pF
		PD7	-	14	-	

ATmega3209/4809 – 48-pin Data Sheet

Electrical Characteristics

Symbol	Description	Condition	Min.	Typ.	Max.	Unit
V _{OFF}	Input Offset Voltage, Low Power Mode	0.7V < V _{IN} < (V _{DD} - 0.7V)	TBD	±10	TBD	mV
		V _{IN} = [0V, V _{DD}]	-	±30	-	
	Input Offset Voltage, High-speed Mode	0.7V < V _{IN} < (V _{DD} - 0.7V)	TBD	±5	TBD	
		V _{IN} = [-0.2V, V _{DD}]	-	±20	-	
I _L	Input Leakage Current		-	5	-	nA
T _{START}	Start-up Time		-	1.3	-	µs
V _{HYS}	Hysteresis, High-speed mode	HYSMODE=0x0	-	0	-	mV
		HYSMODE=0x1	-	10	-	
		HYSMODE=0x2	-	25	-	
		HYSMODE=0x3	-	50	-	
t _{PD}	Propagation Delay	25 mV Overdrive, V _{DD} ≥ 2.7V, High speed mode	-	50	-	ns
		25 mV Overdrive, V _{DD} ≥ 2.7V, Low Power Mode	-	150	-	

5.13 UPDI Timing

UPDI Enable Sequence

Symbol	Description	Min.	Max.	Unit
T _{RES}	Duration of Handshake/Break on RESET	10	200	µs
T _{UPDI}	Duration of UPDI.txd=0	10	200	µs
T _{Deb0}	Duration of Debugger.txd=0	0.2	1	µs
T _{DebZ}	Duration of Debugger.txd=z	200	14000	µs

6. Typical Characteristics

6.1 Power Consumption

6.1.1 Supply Currents in Active Mode

Figure 6-1. Active Supply Current vs. Frequency (1-20 MHz) at T=25°C

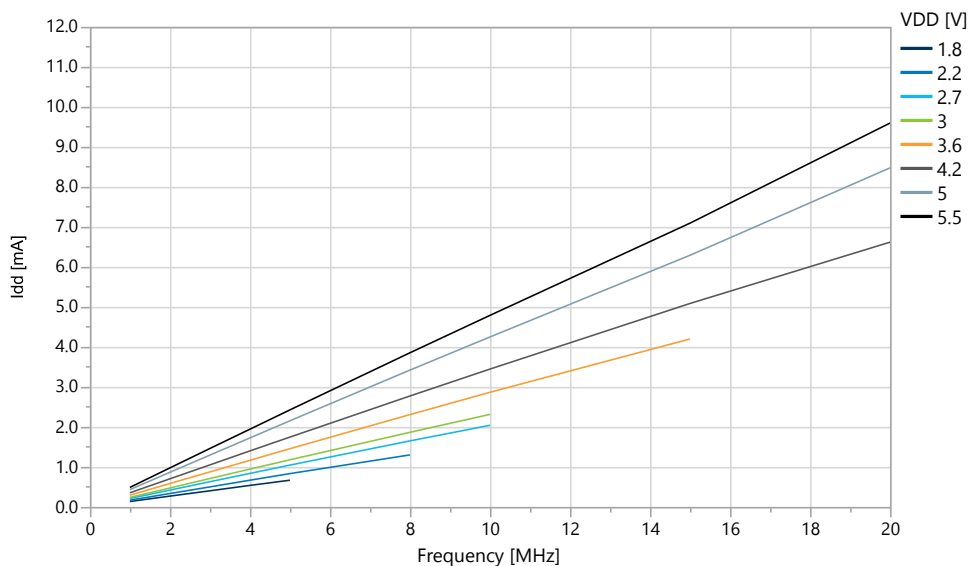
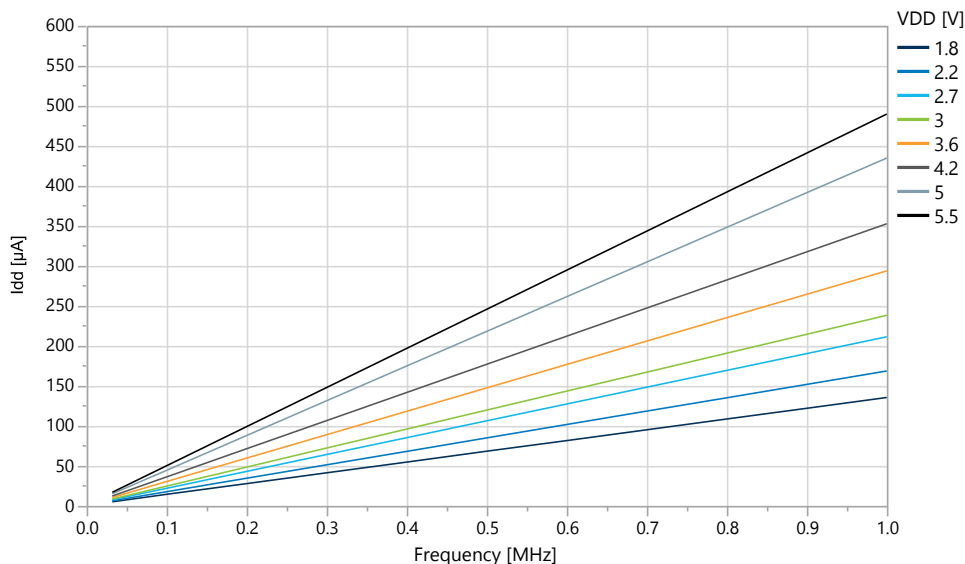

Figure 6-2. Active Supply Current vs. Frequency [0.1, 1.0] MHz at T=25°C



ATmega3209/4809 – 48-pin Data Sheet

Typical Characteristics

Figure 6-3. Active Supply Current vs. Temperature (f=20 MHz OSC20M)

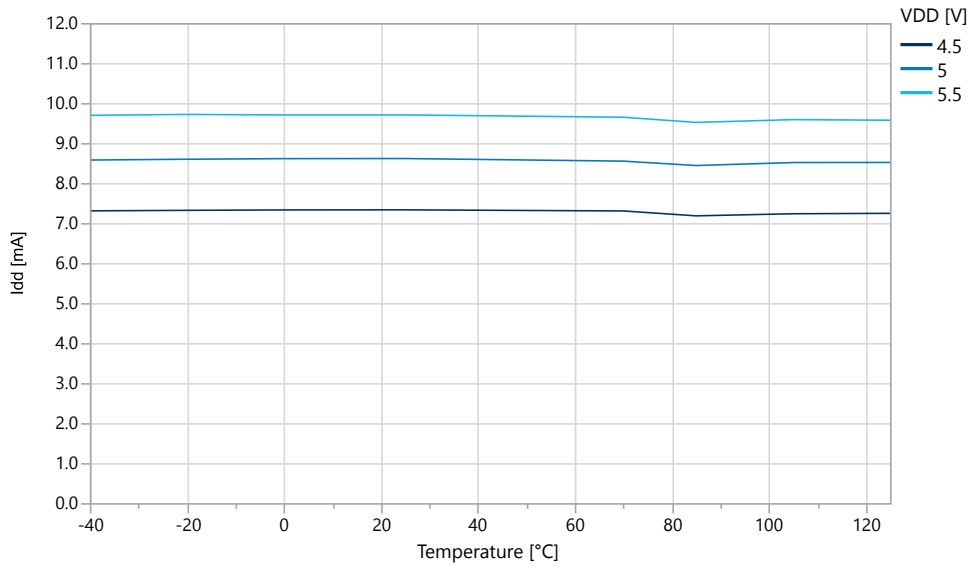

Figure 6-4. Active Supply Current vs. V_{DD} (f=[1.25, 20] MHz OSC20M) at T=25 $^{\circ}\text{C}$

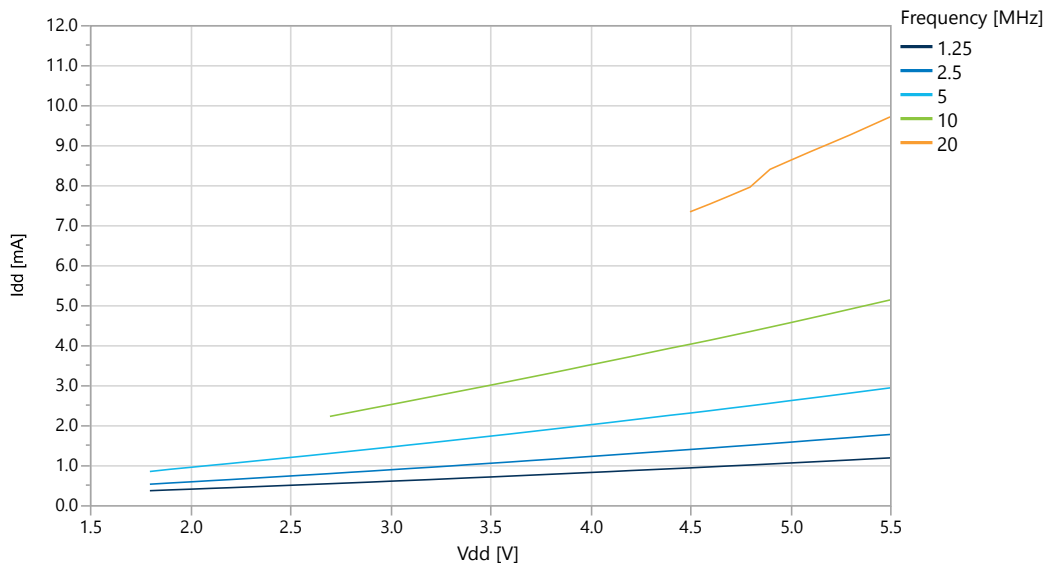
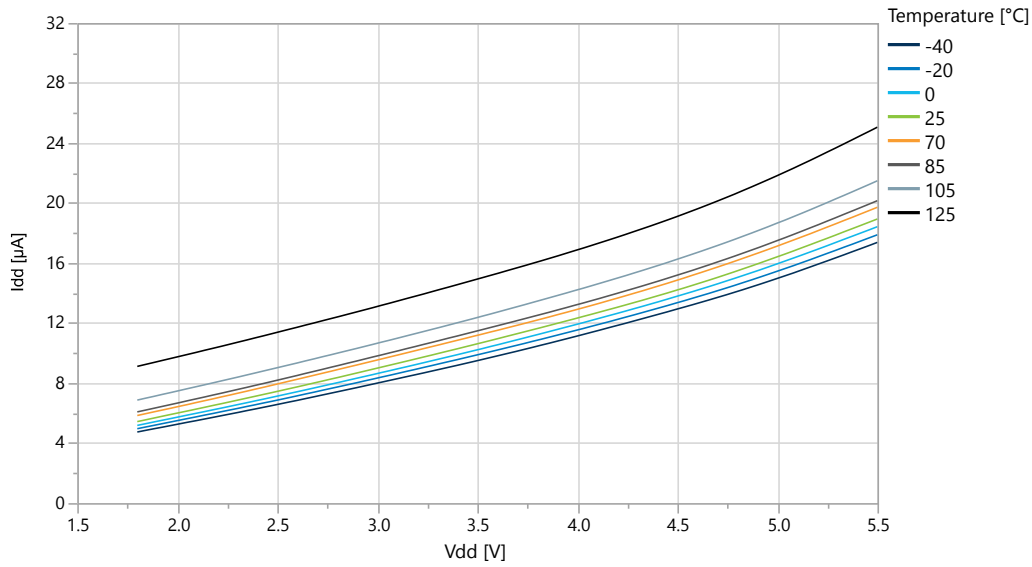
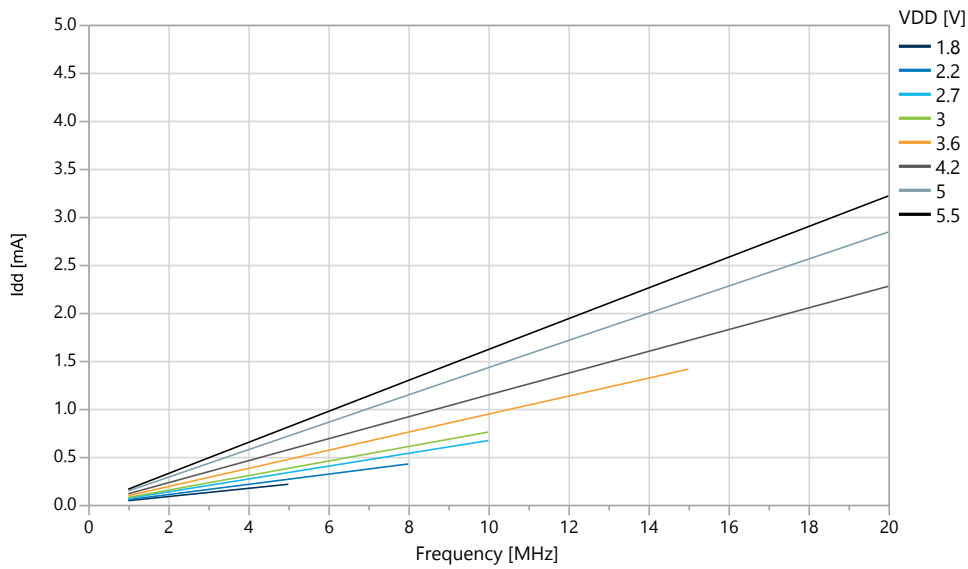

Figure 6-5. Active Supply Current vs. V_{DD} (f=32 KHz OSCULP32K)



6.1.2 Supply Currents in Idle Mode

Figure 6-6. Idle Supply Current vs. Frequency (1-20 MHz) at $T=25^{\circ}C$



ATmega3209/4809 – 48-pin Data Sheet

Typical Characteristics

Figure 6-7. Idle Supply Current vs. Low Frequency (0.1-1.0 MHz) at T=25°C

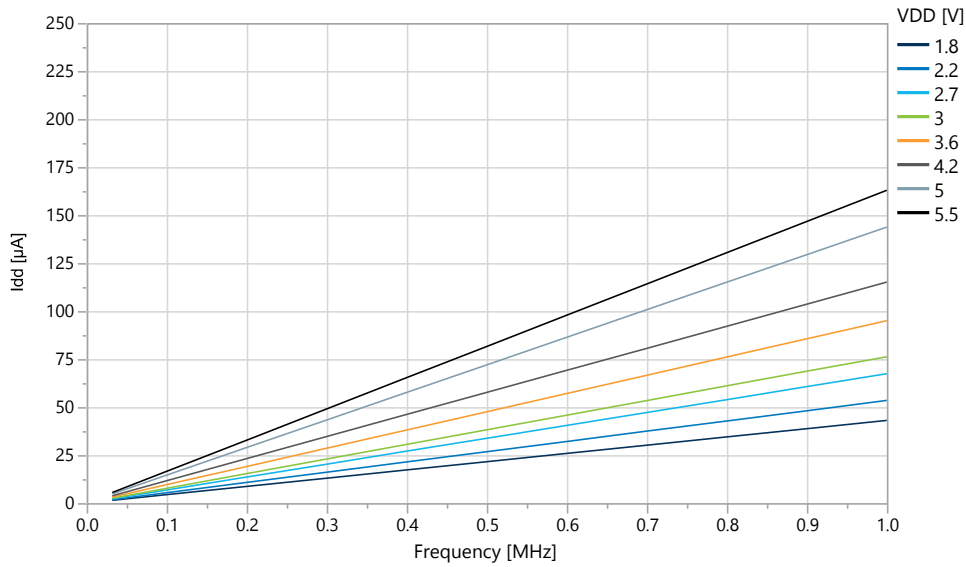

Figure 6-8. Idle Supply Current vs. Temperature (f=20 MHz OSC20M)

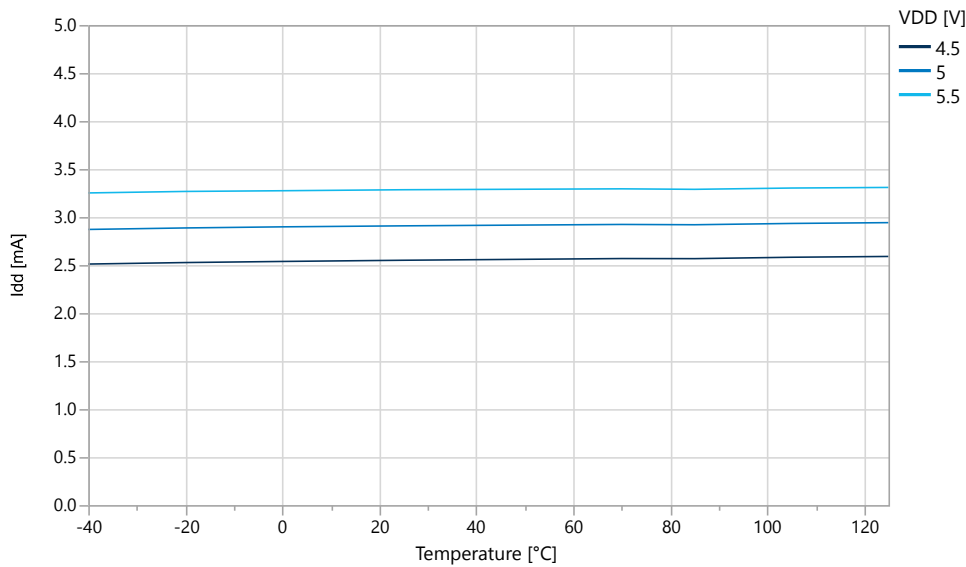
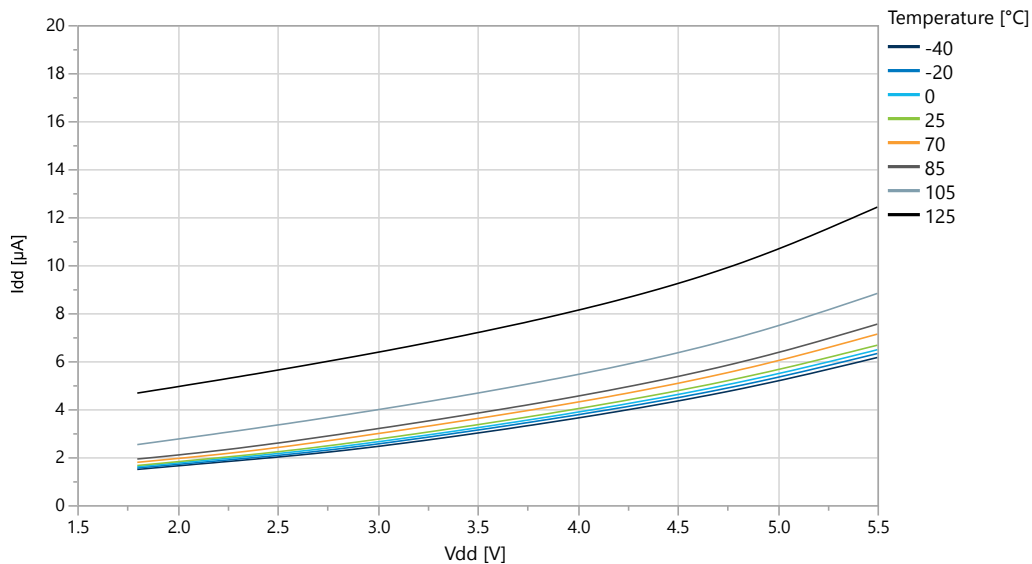
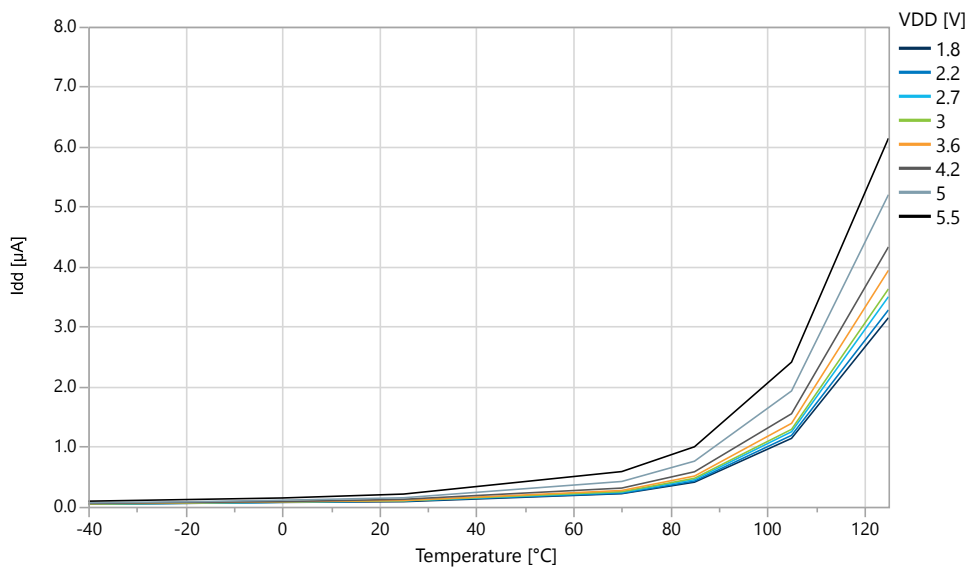

Figure 6-9. Idle Supply Current vs. V_{DD} (f=32 KHz OSCULP32K)



6.1.3 Supply Currents in Power-Down Mode

Figure 6-10. Power-Down Mode Supply Current vs. Temperature (all functions disabled)



ATmega3209/4809 – 48-pin Data Sheet

Typical Characteristics

Figure 6-11. Power-Down Mode Supply Current vs. V_{DD} (all functions disabled)

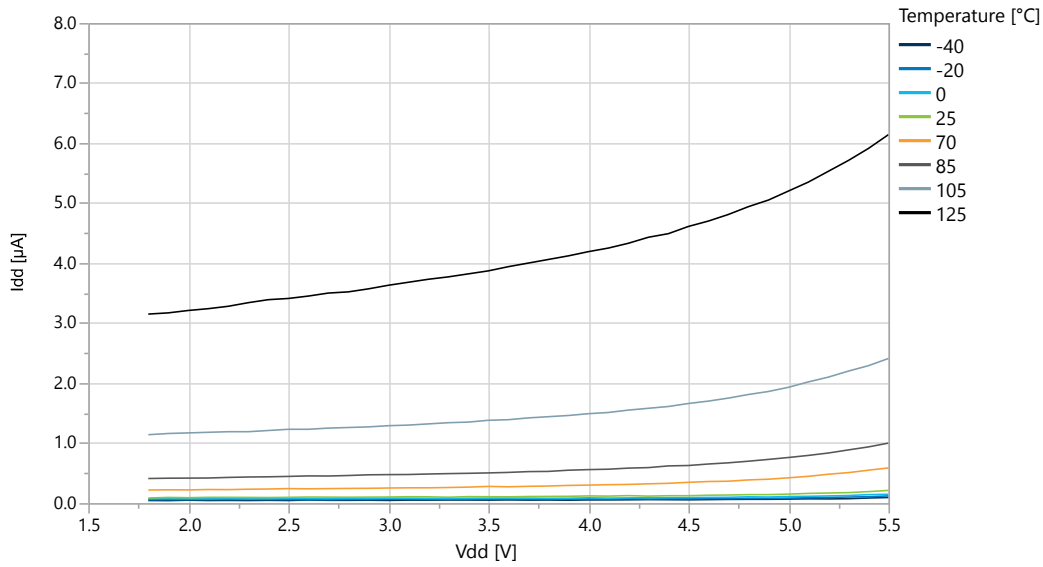
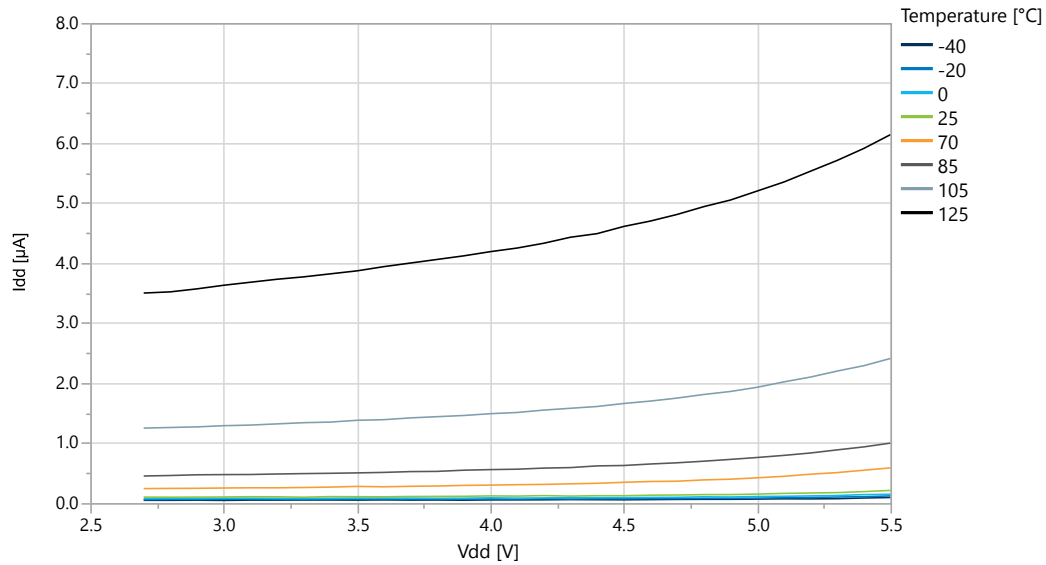

Figure 6-12. Power-Down Mode Supply Current vs. V_{DD} (all functions disabled)



6.1.4 Supply Currents in Standby Mode

Figure 6-13. Standby Mode Supply Current vs. V_{DD} (RTC running with internal OSCULP32K)

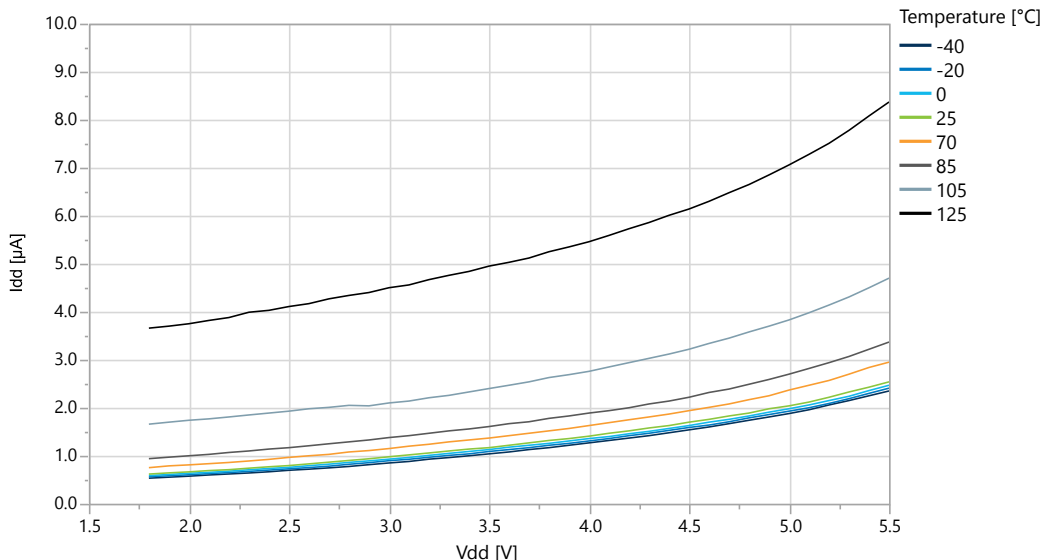

Figure 6-14. Standby Mode Supply Current vs. V_{DD} (Sampled BOD running at 125 Hz)

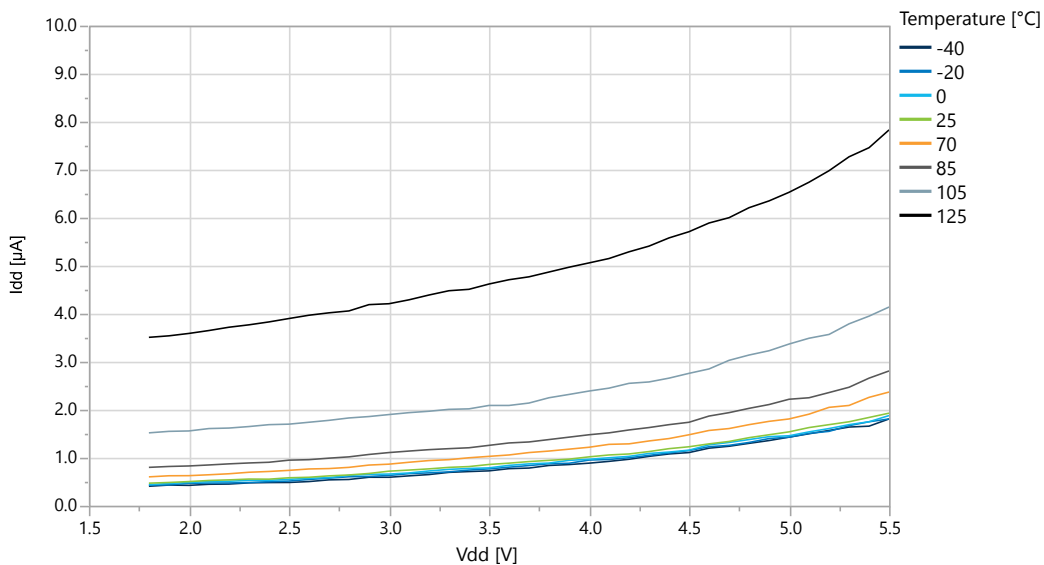
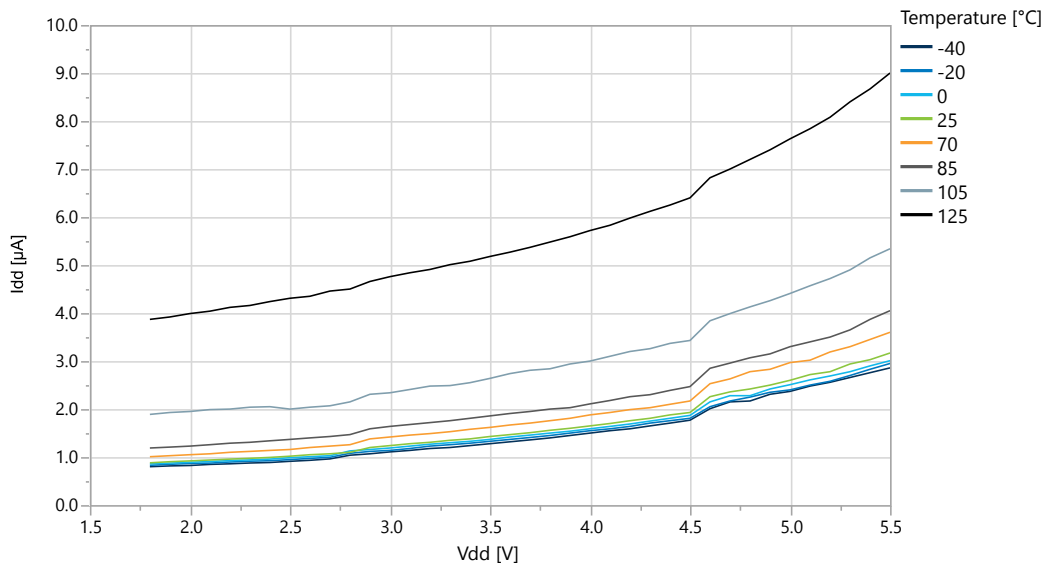
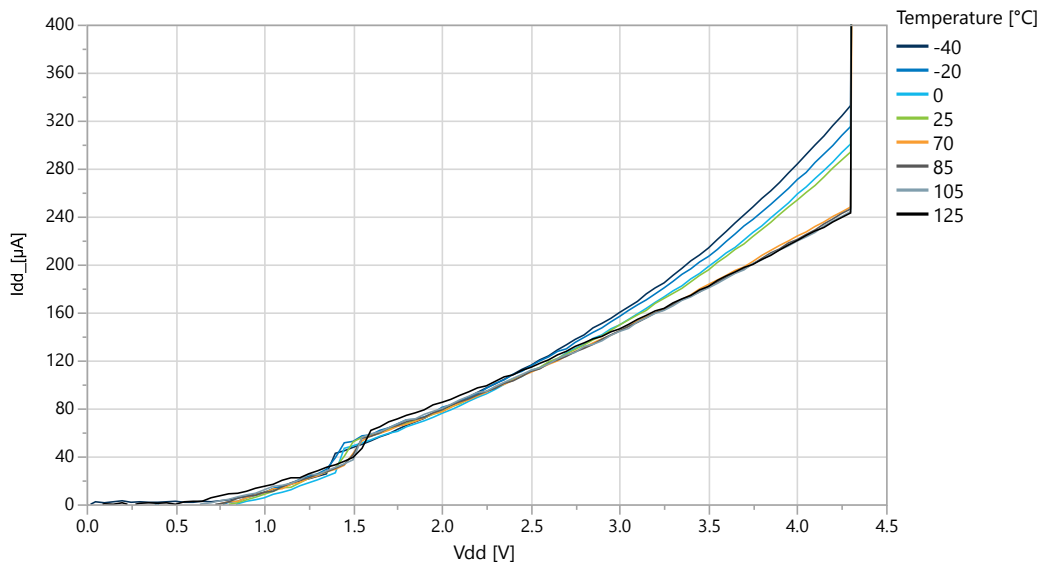

Figure 6-15. Standby Mode Supply Current vs. V_{DD} (Sampled BOD running at 1 kHz)



6.1.5 Power on Supply Currents

Figure 6-16. Power-on Supply Current vs. V_{DD} (BOD enabled at 4.3V level)



6.2 GPIO

GPIO Input Characteristics

Figure 6-17. I/O Pin Input Hysteresis vs. V_{DD}

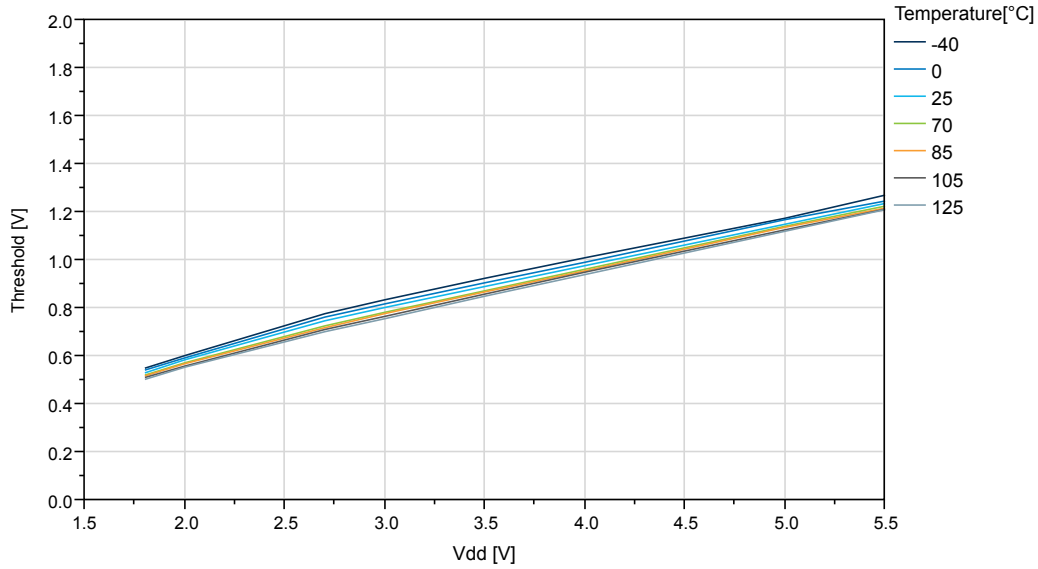

Figure 6-18. I/O Pin Input Threshold Voltage vs. V_{DD} ($T=25^{\circ}\text{C}$)

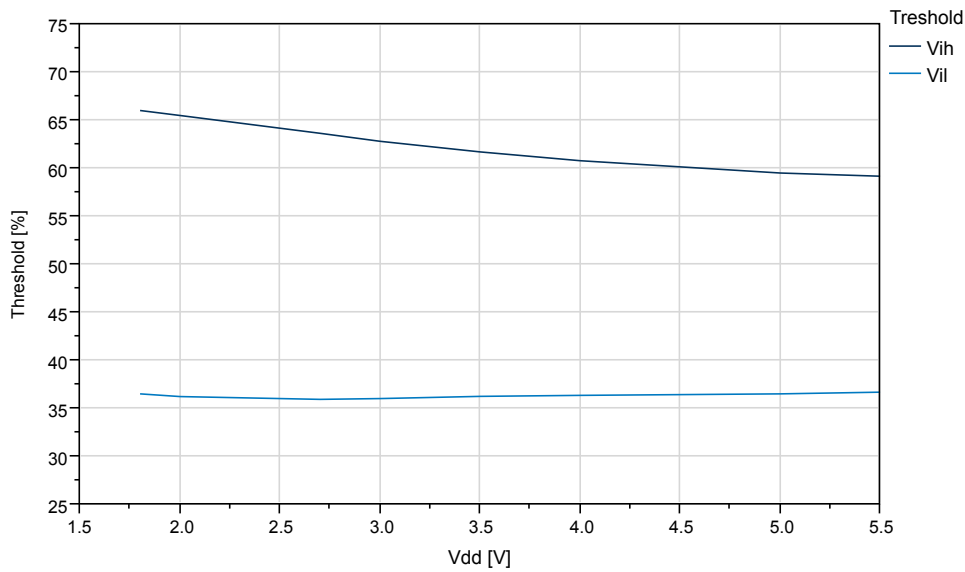

Figure 6-19. I/O Pin Input Threshold Voltage vs. V_{DD} (V_{IH})

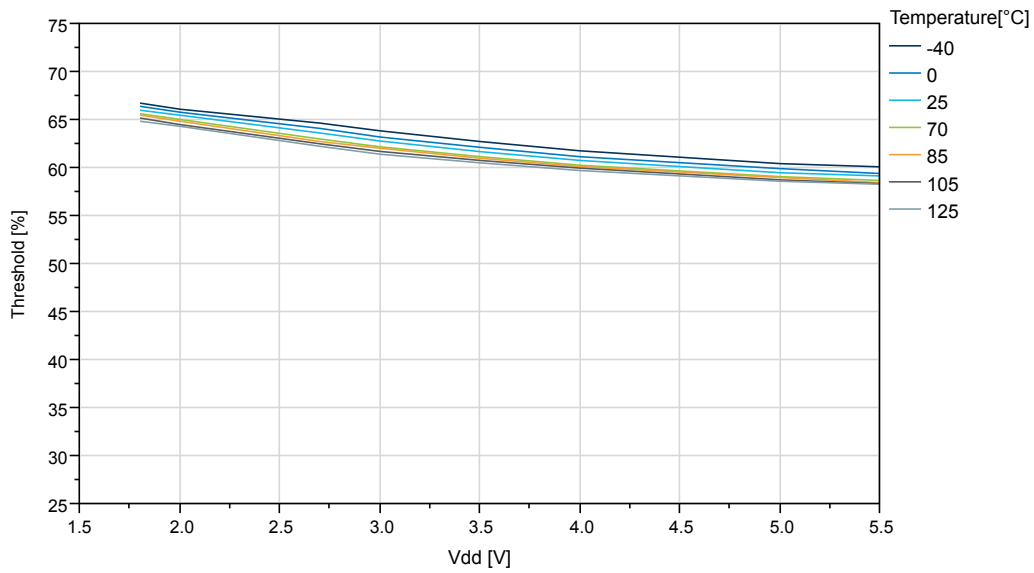
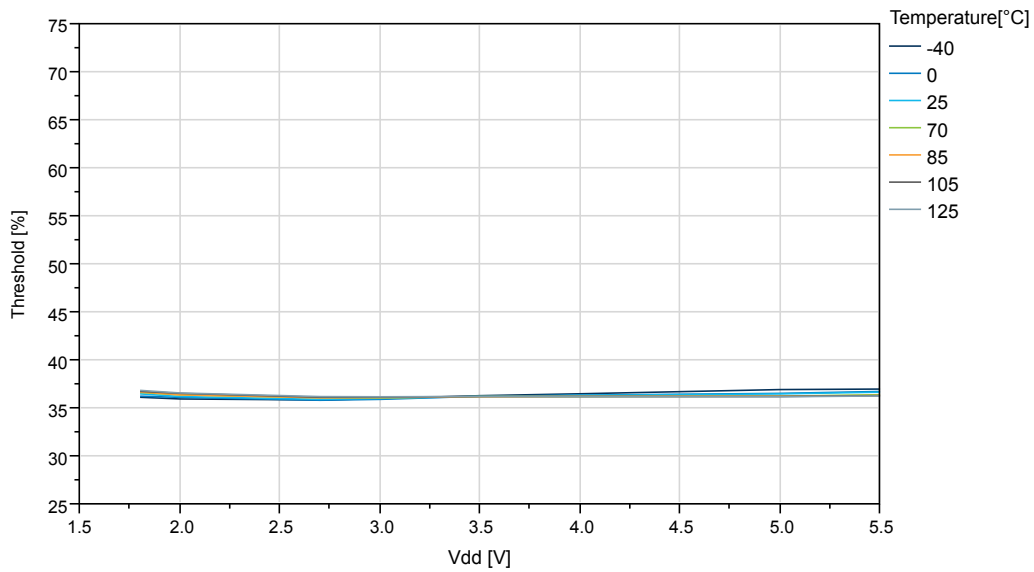

Figure 6-20. I/O Pin Input Threshold Voltage vs. V_{DD} (V_{IL})



GPIO Output Characteristics

Figure 6-21. I/O Pin Output Voltage vs. Sink Current ($V_{DD}=1.8V$)

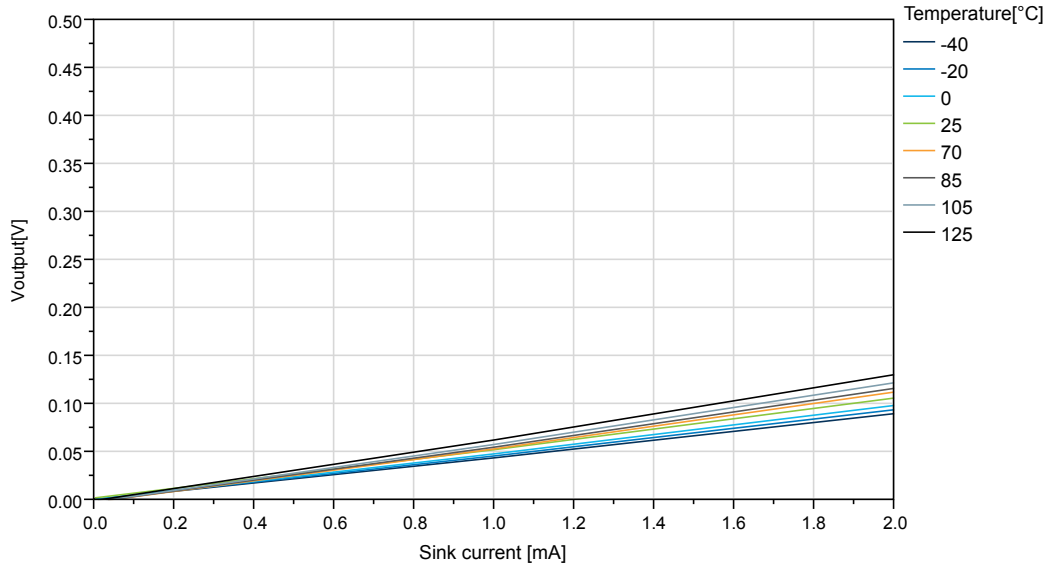
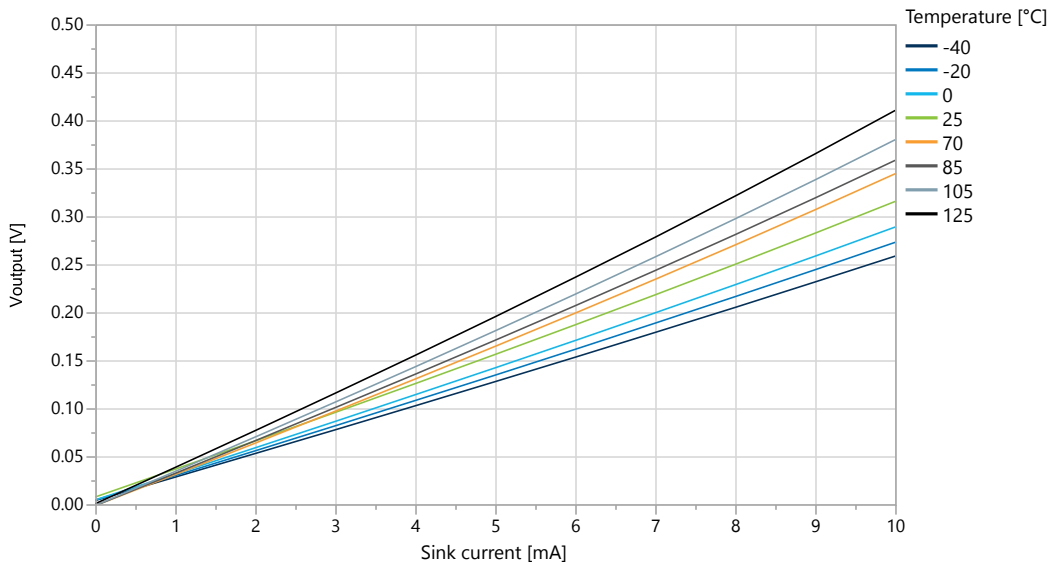

Figure 6-22. I/O Pin Output Voltage vs. Sink Current ($V_{DD}=3.0V$)



ATmega3209/4809 – 48-pin Data Sheet

Typical Characteristics

Figure 6-23. I/O Pin Output Voltage vs. Sink Current ($V_{DD}=5.0V$)

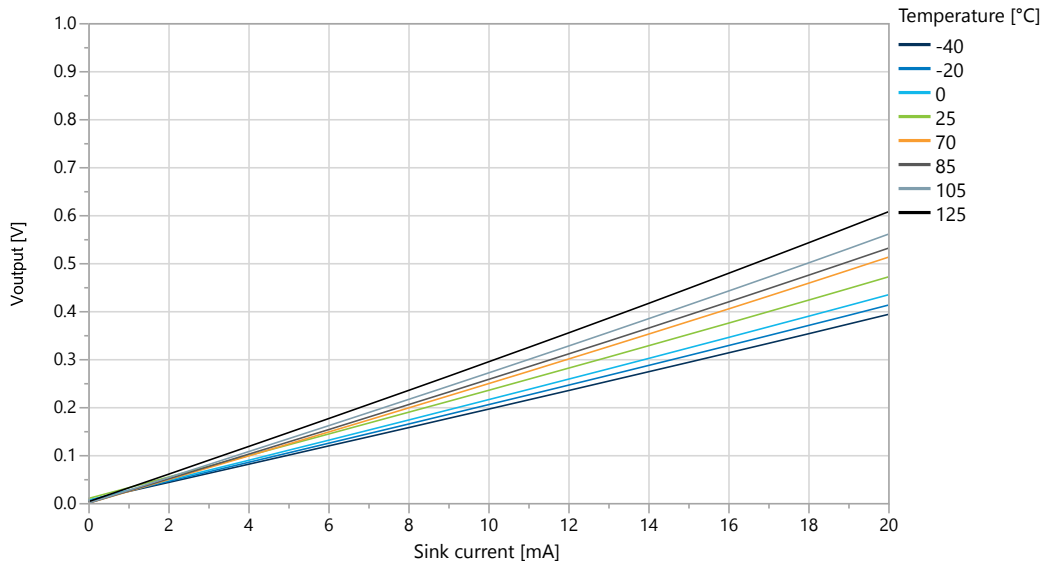
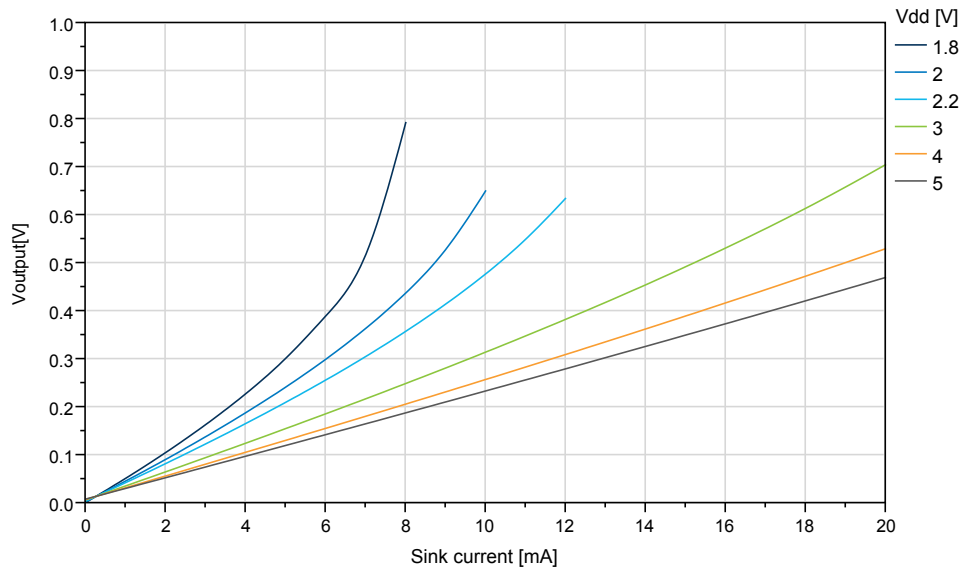

Figure 6-24. I/O Pin Output Voltage vs. Sink Current ($T=25^{\circ}C$)



ATmega3209/4809 – 48-pin Data Sheet

Typical Characteristics

Figure 6-25. I/O Pin Output Voltage vs. Source Current ($V_{DD}=1.8V$)

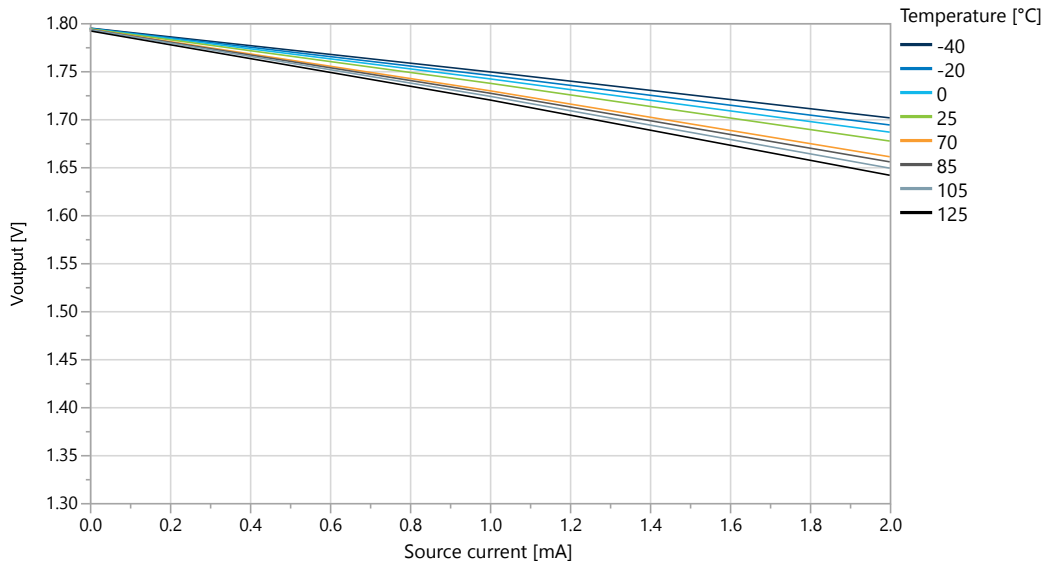
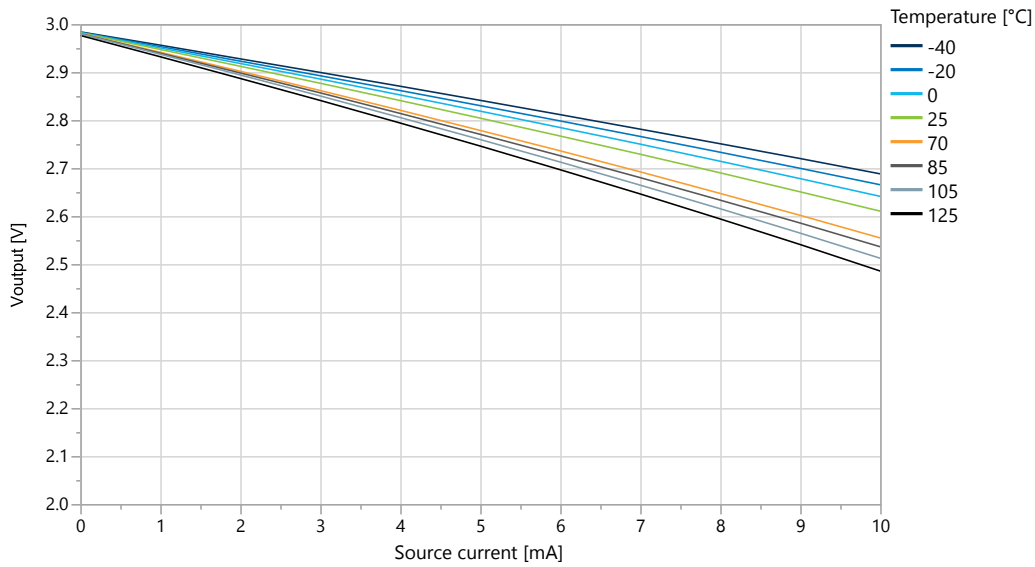

Figure 6-26. I/O Pin Output Voltage vs. Source Current ($V_{DD}=3.0V$)



ATmega3209/4809 – 48-pin Data Sheet

Typical Characteristics

Figure 6-27. I/O Pin Output Voltage vs. Source Current ($V_{DD}=5.0V$)

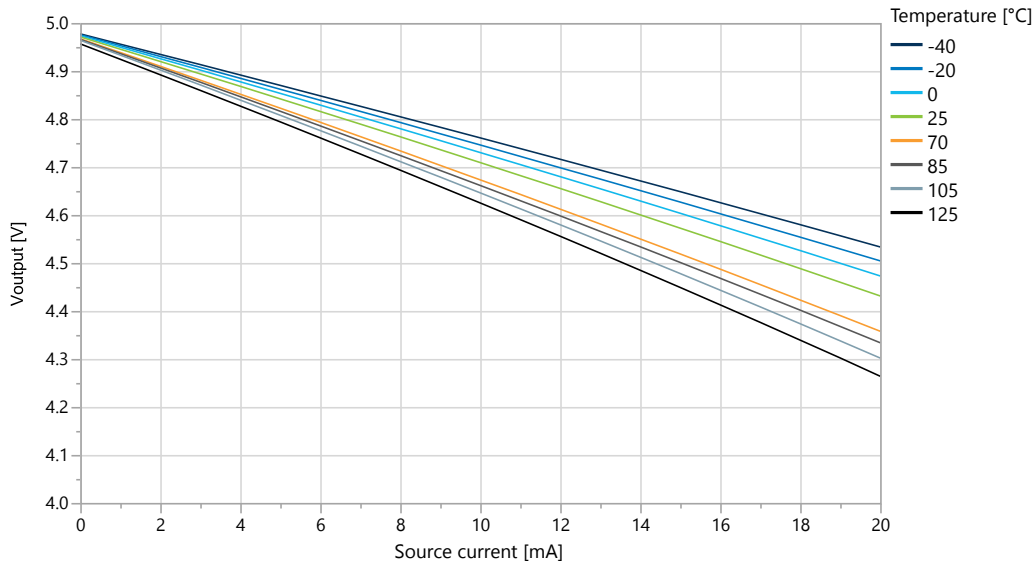
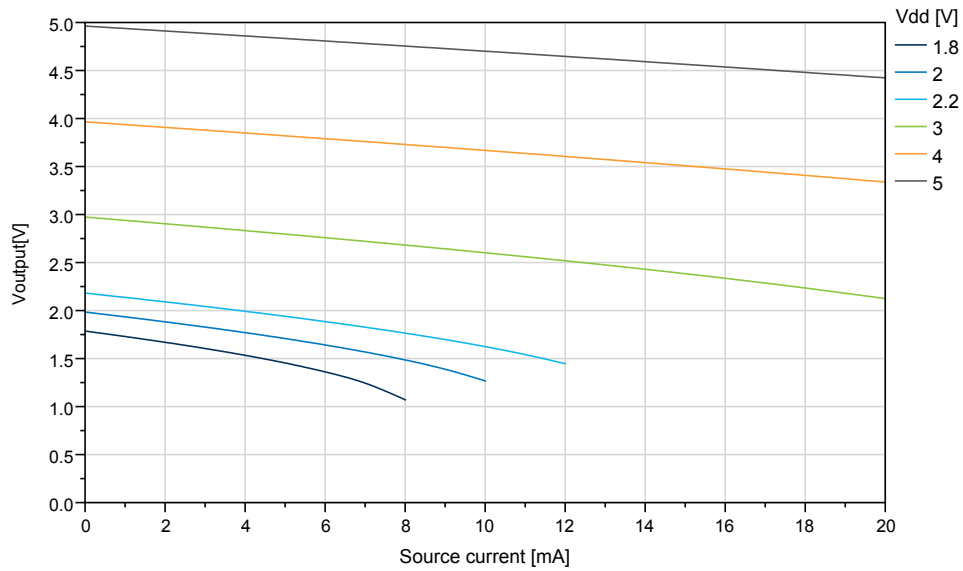

Figure 6-28. I/O Pin Output Voltage vs. Source Current ($T=25^{\circ}C$)



GPIO Pull-Up Characteristics

Figure 6-29. I/O Pin Pull-Up Resistor Current vs. Input Voltage ($V_{DD}=1.8V$)

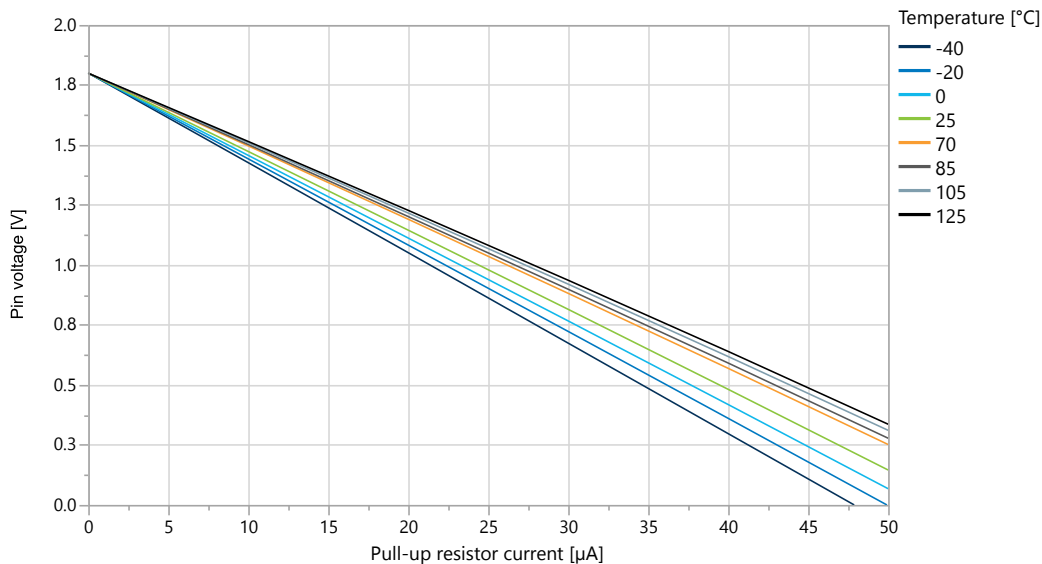

Figure 6-30. I/O Pin Pull-Up Resistor Current vs. Input Voltage ($V_{DD}=3.0V$)

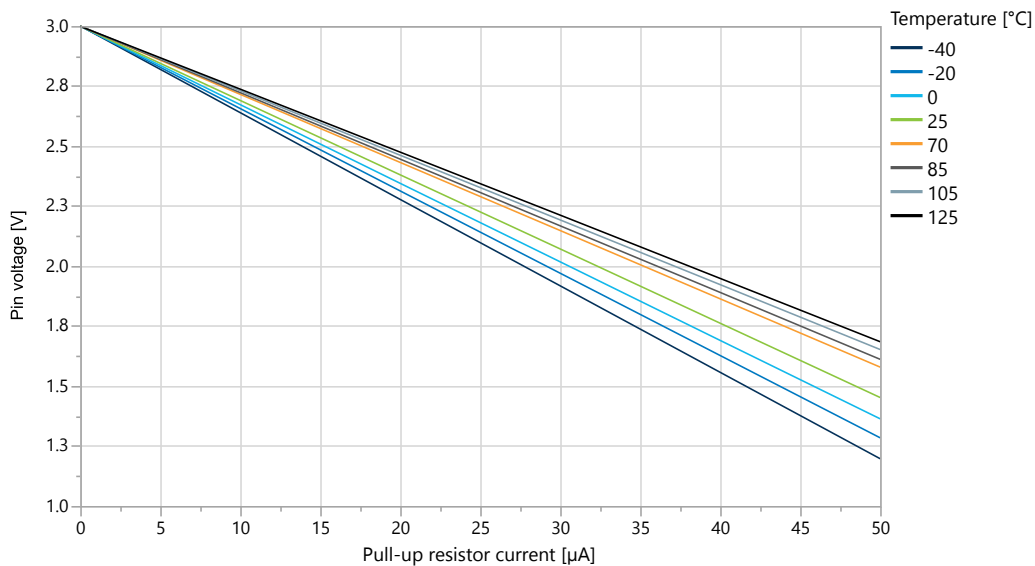
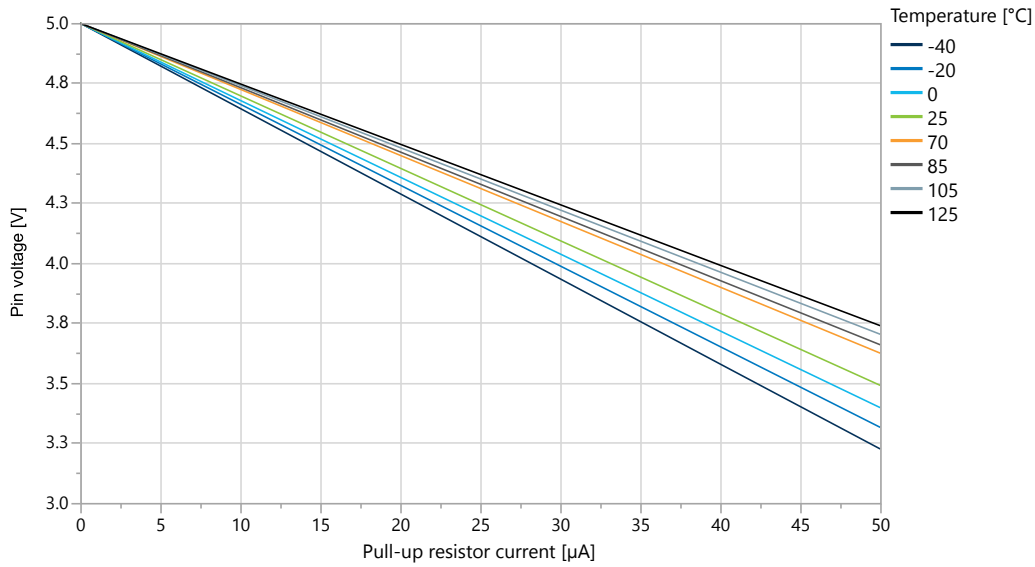

Figure 6-31. I/O Pin Pull-Up Resistor Current vs. Input Voltage ($V_{DD}=5.0V$)



6.3 VREF Characteristics

Figure 6-32. Internal 0.55V Reference vs. Temperature

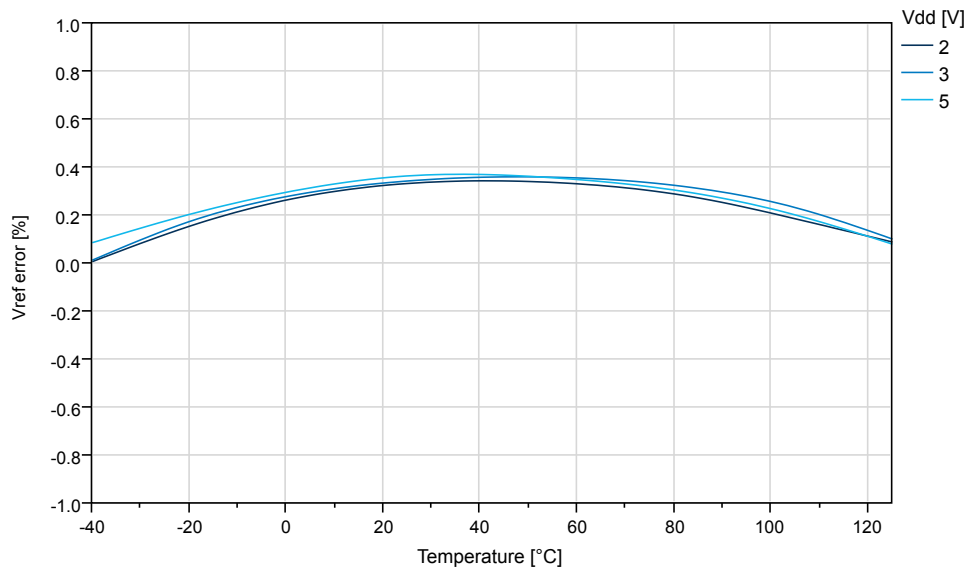

Figure 6-33. Internal 1.1V Reference vs. Temperature

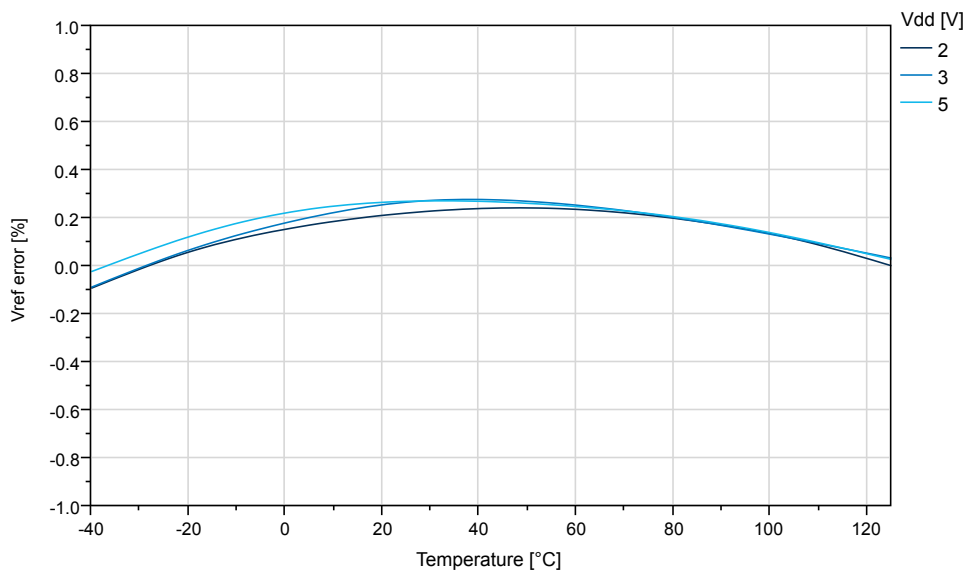

Figure 6-34. Internal 2.5V Reference vs. Temperature

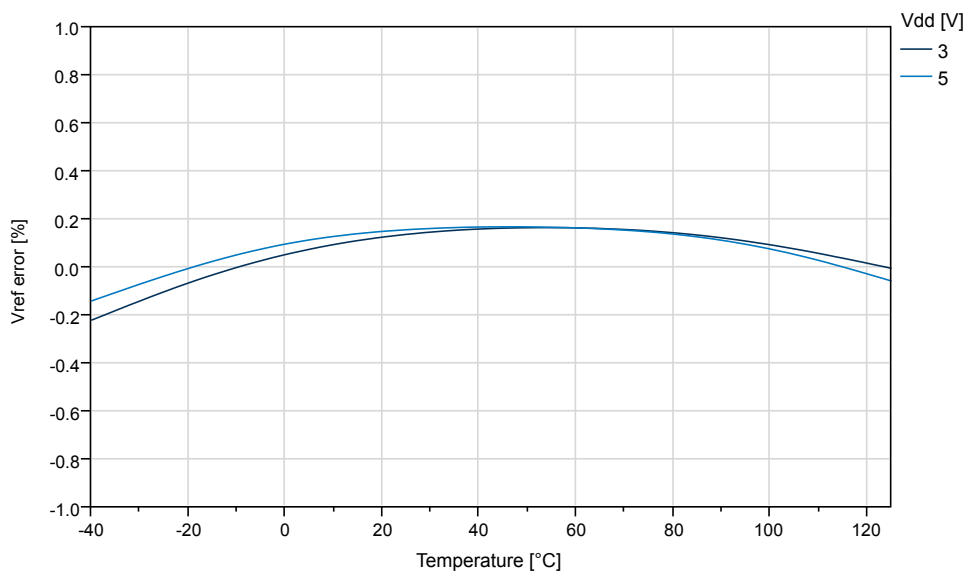
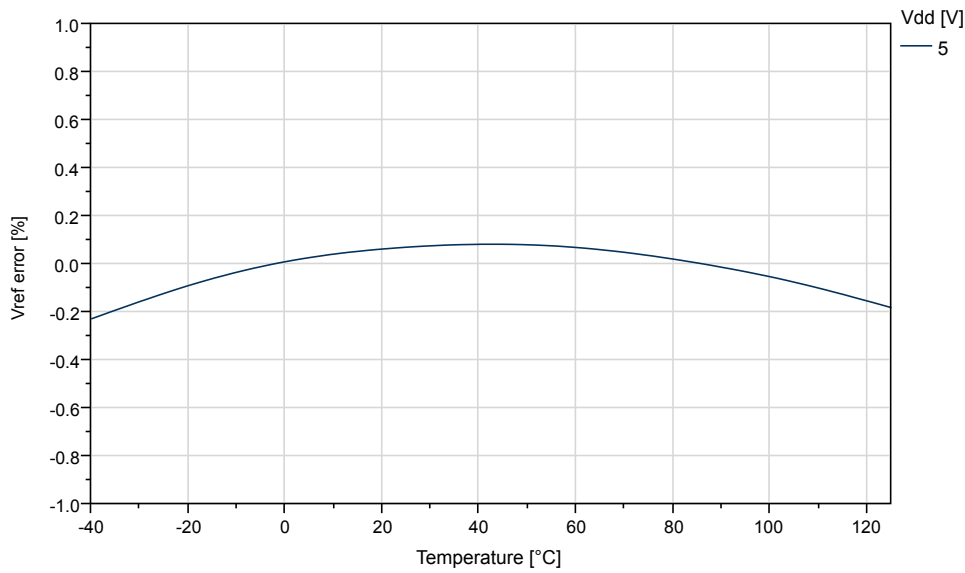

Figure 6-35. Internal 4.3V Reference vs. Temperature



6.4 BOD Characteristics

BOD Current vs. V_{DD}

Figure 6-36. BOD Current vs. V_{DD} (Continuous Mode Enabled)

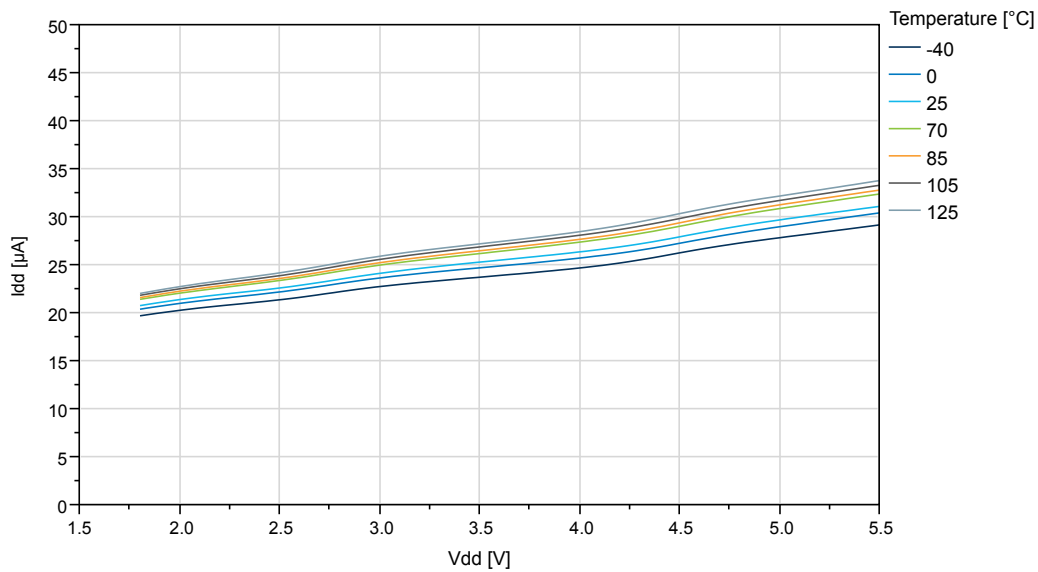

Figure 6-37. BOD Current vs. V_{DD} (Sampled BOD at 125 Hz)

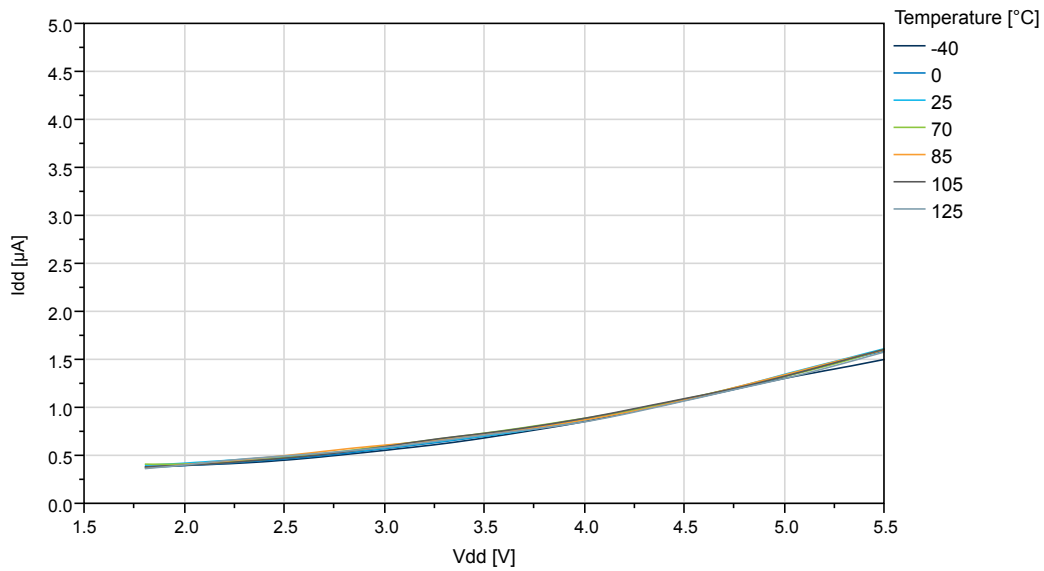
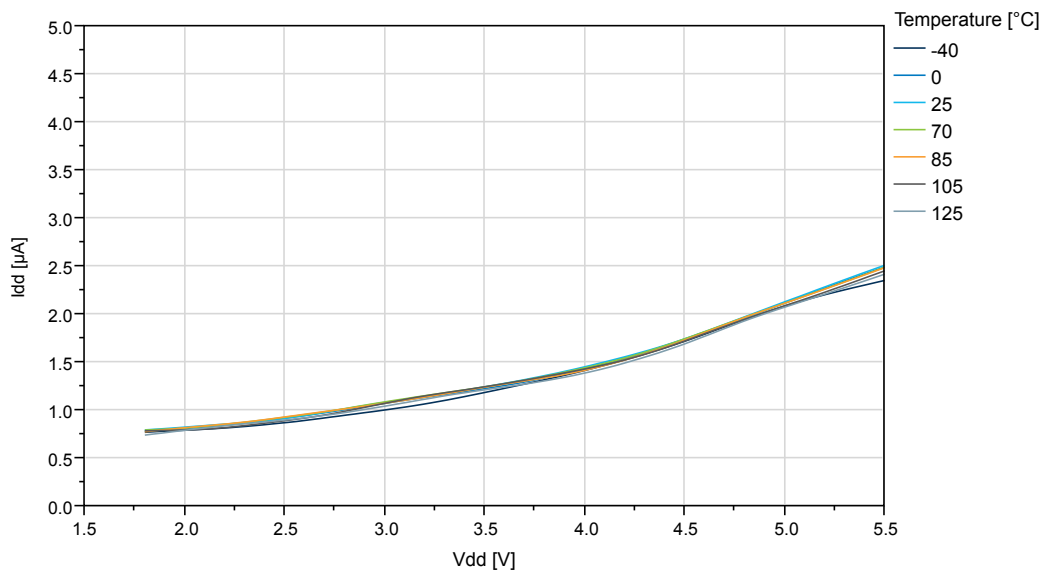

Figure 6-38. BOD Current vs. V_{DD} (Sampled BOD at 1 kHz)



BOD Threshold vs. Temperature

Figure 6-39. BOD Threshold vs. Temperature (Level 1.8V)

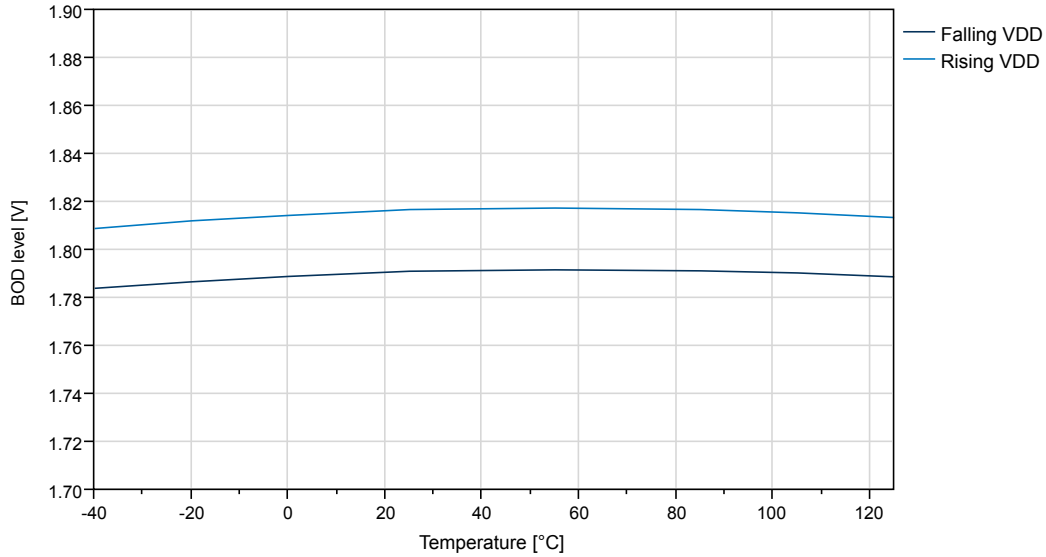

Figure 6-40. BOD Threshold vs. Temperature (Level 2.6V)

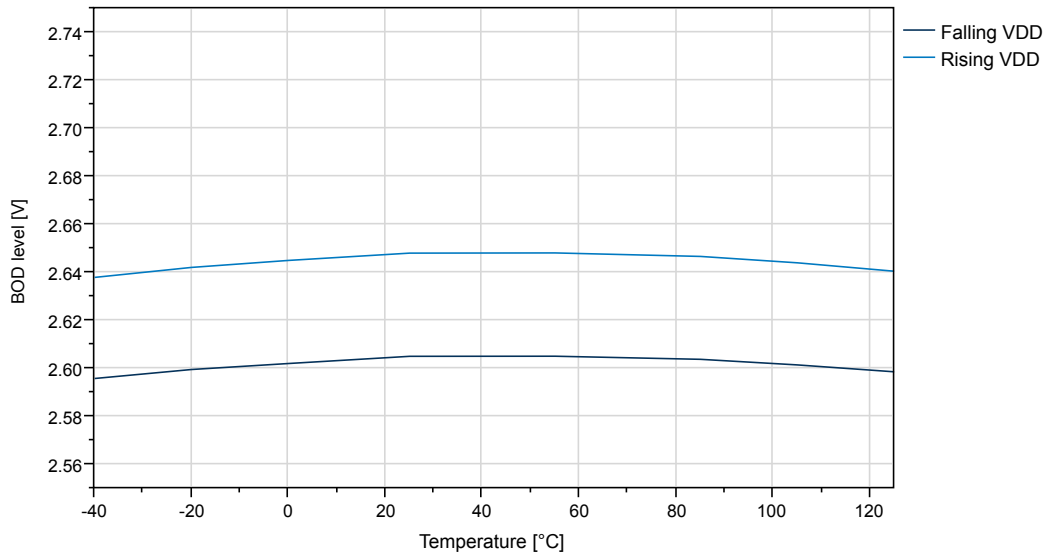
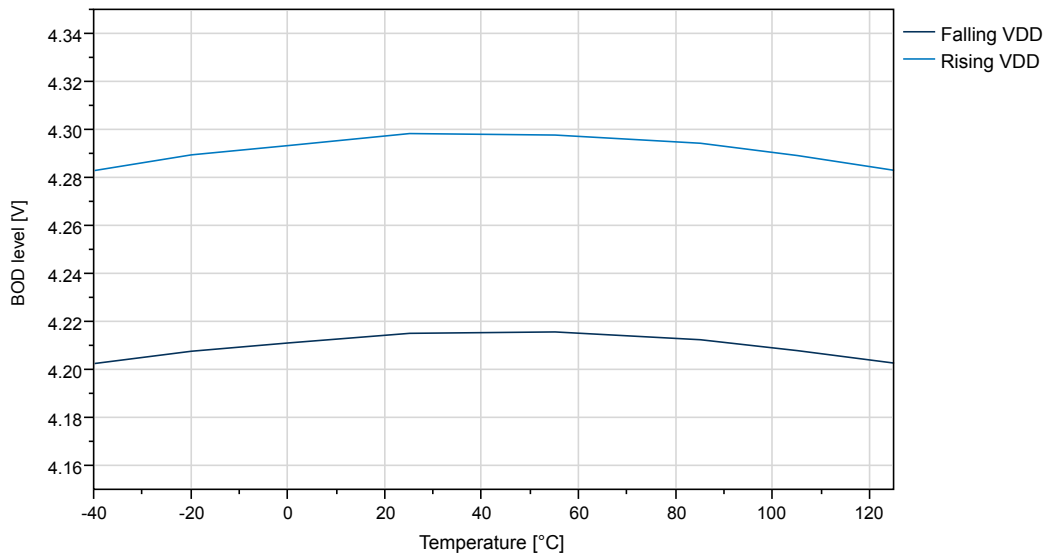
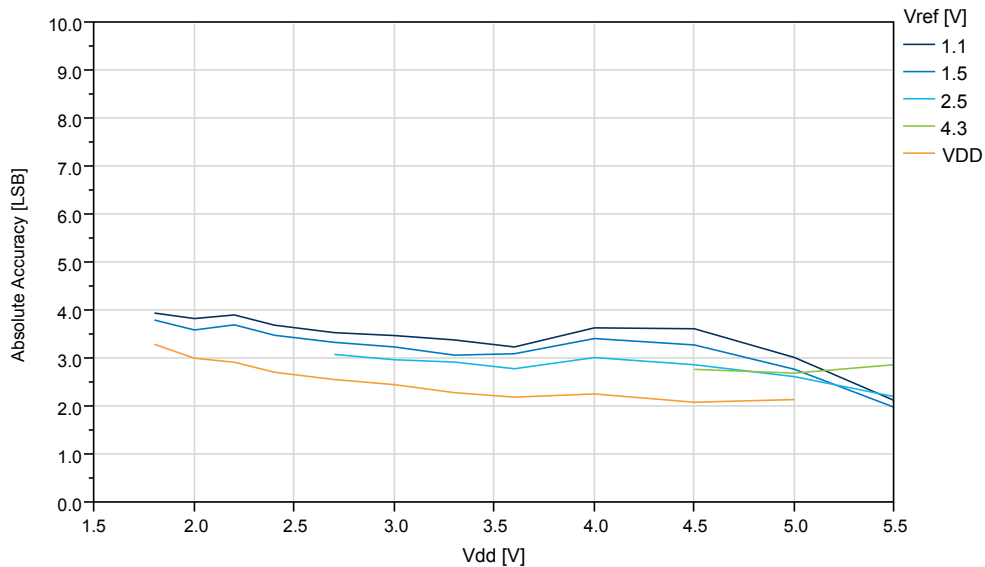

Figure 6-41. BOD Threshold vs. Temperature (Level 4.3V)



6.5 ADC Characteristics

Figure 6-42. Absolute Accuracy vs. V_{DD} ($f_{ADC}=115$ ksps) at $T=25^{\circ}\text{C}$, REFSEL = Internal Reference



ATmega3209/4809 – 48-pin Data Sheet

Typical Characteristics

Figure 6-43. Absolute Accuracy vs. V_{ref} ($V_{DD}=5.0V$, $f_{ADC}=115$ ksp/s), REFSEL = Internal Reference

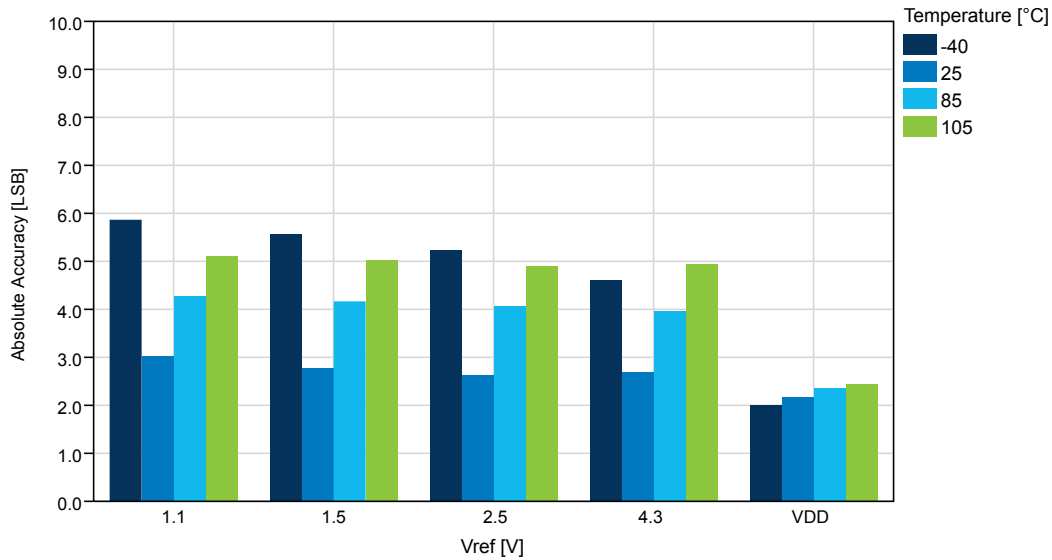
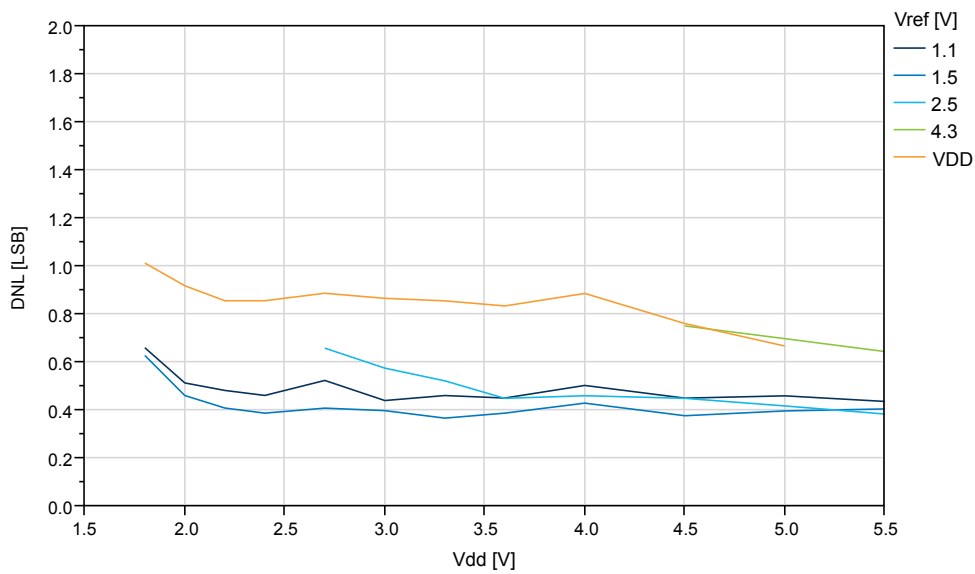

Figure 6-44. DNL Error vs. V_{DD} ($f_{ADC}=115$ ksp/s) at $T=25^{\circ}C$, REFSEL = Internal Reference



ATmega3209/4809 – 48-pin Data Sheet

Typical Characteristics

Figure 6-45. DNL vs. V_{ref} ($V_{DD}=5.0V$, $f_{ADC}=115$ kps), REFSEL = Internal Reference

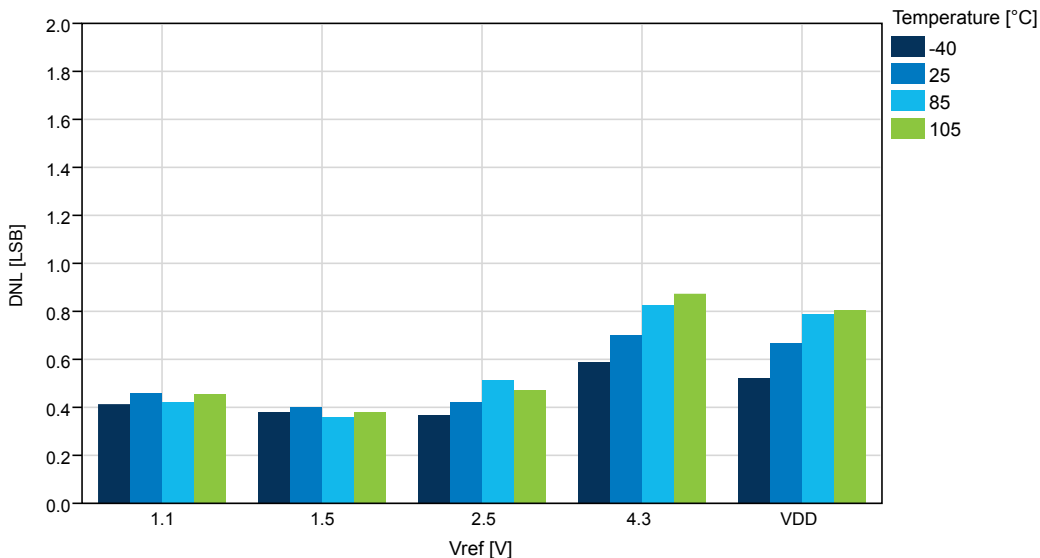
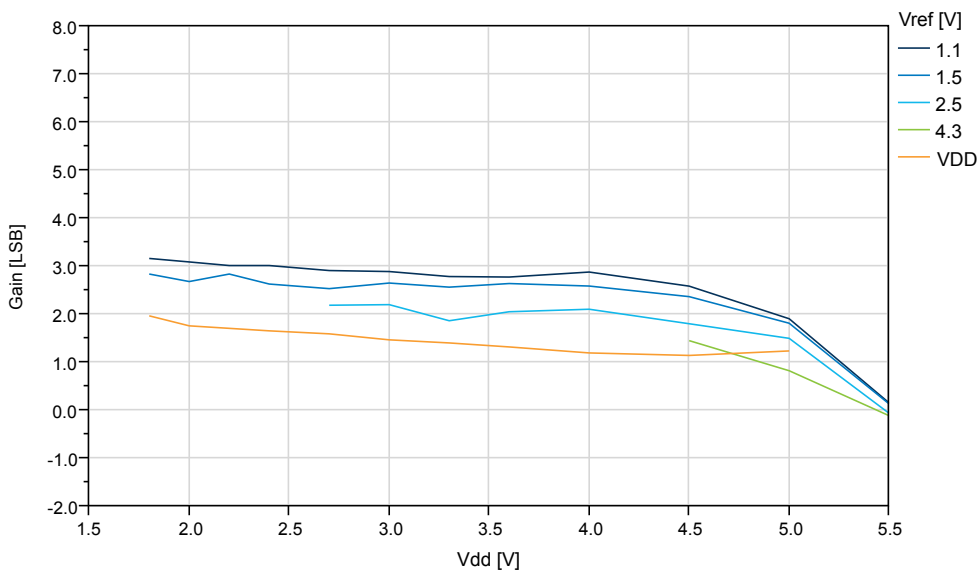

Figure 6-46. Gain Error vs. V_{DD} ($f_{ADC}=115$ kps) at $T=25^{\circ}C$, REFSEL = Internal Reference



ATmega3209/4809 – 48-pin Data Sheet

Typical Characteristics

Figure 6-47. Gain Error vs. V_{ref} ($V_{DD}=5.0V$, $f_{ADC}=115$ ksp/s), REFSEL = Internal Reference

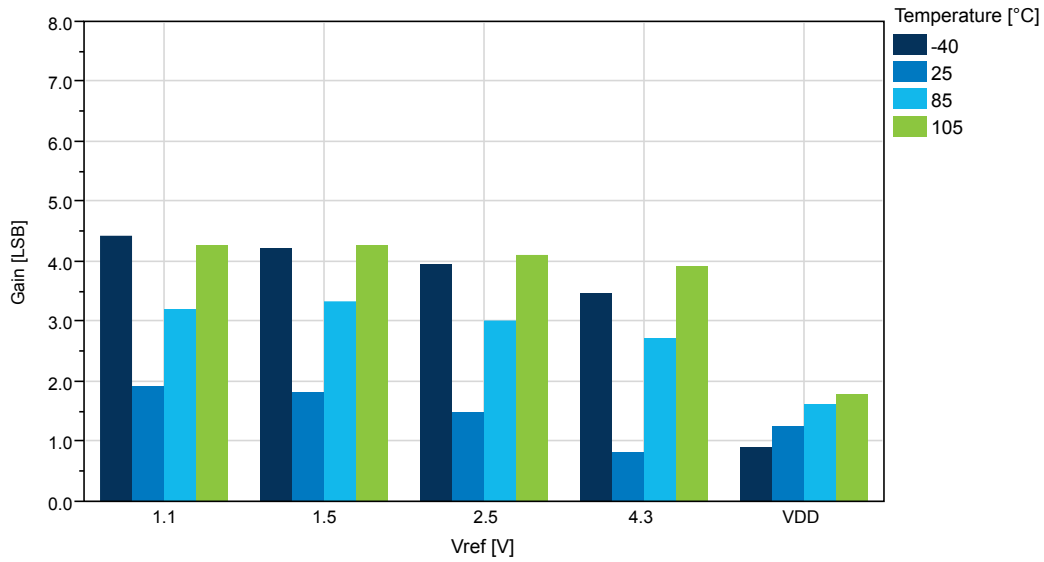
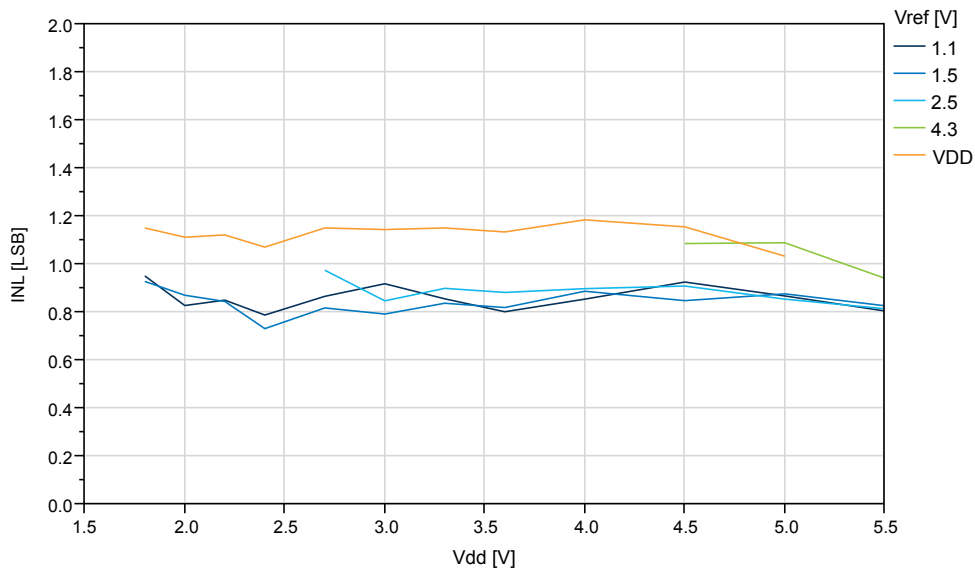

Figure 6-48. INL vs. V_{DD} ($f_{ADC}=115$ ksp/s) at $T=25^{\circ}C$, REFSEL = Internal Reference



ATmega3209/4809 – 48-pin Data Sheet

Typical Characteristics

Figure 6-49. INL vs. V_{ref} ($V_{DD}=5.0V$, $f_{ADC}=115$ ksp/s), REFSEL = Internal Reference

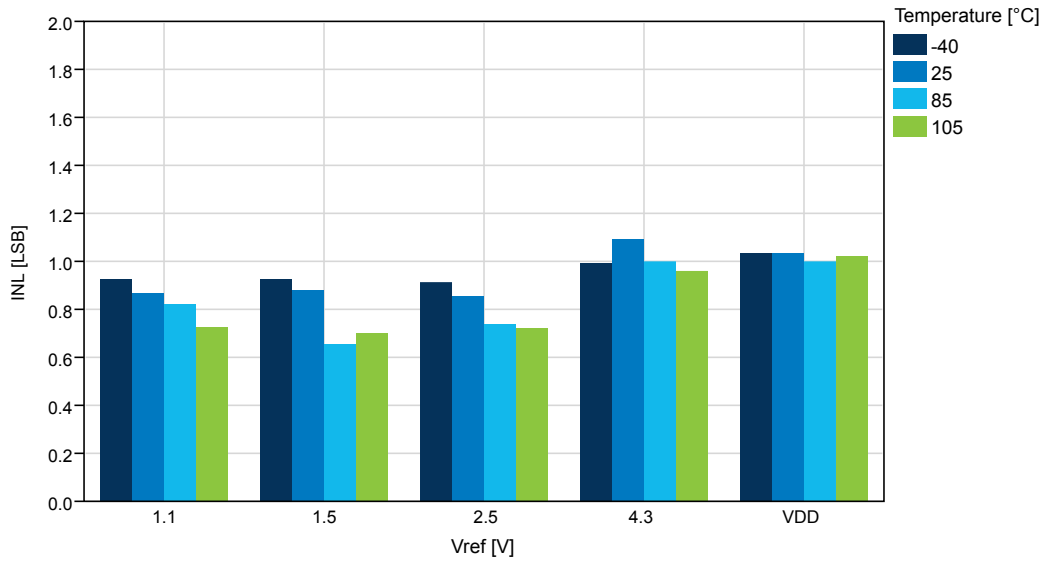
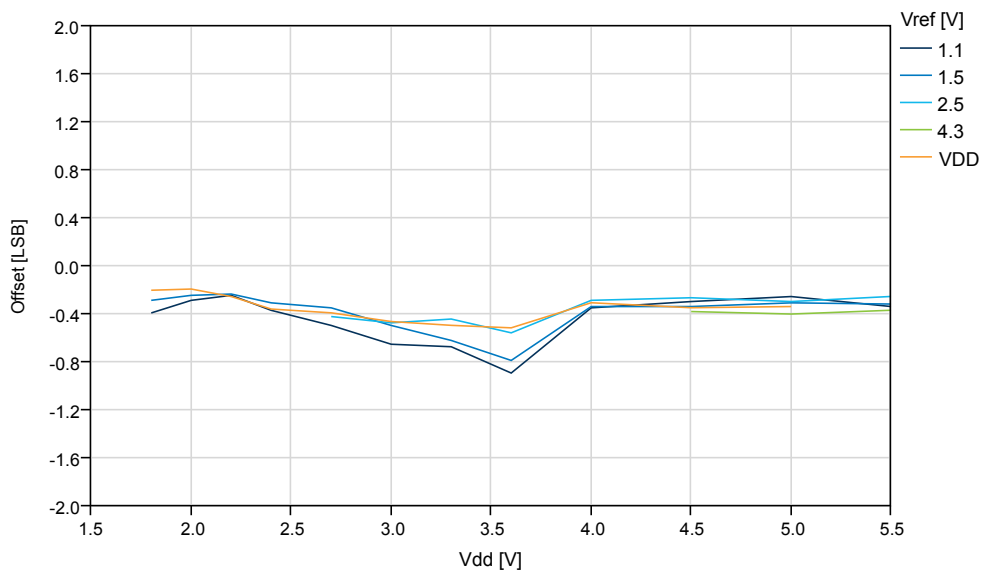

Figure 6-50. Offset Error vs. V_{DD} ($f_{ADC}=115$ ksp/s) at $T=25^{\circ}C$, REFSEL = Internal Reference



ATmega3209/4809 – 48-pin Data Sheet

Typical Characteristics

Figure 6-51. Offset Error vs. V_{ref} ($V_{DD}=5.0V$, $f_{ADC}=115$ kps), REFSEL = Internal Reference

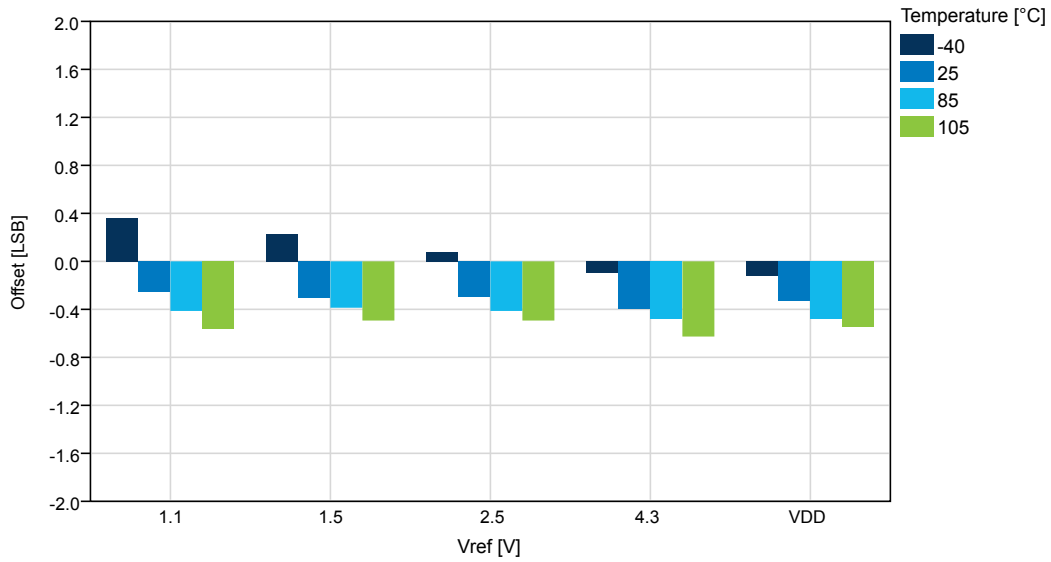
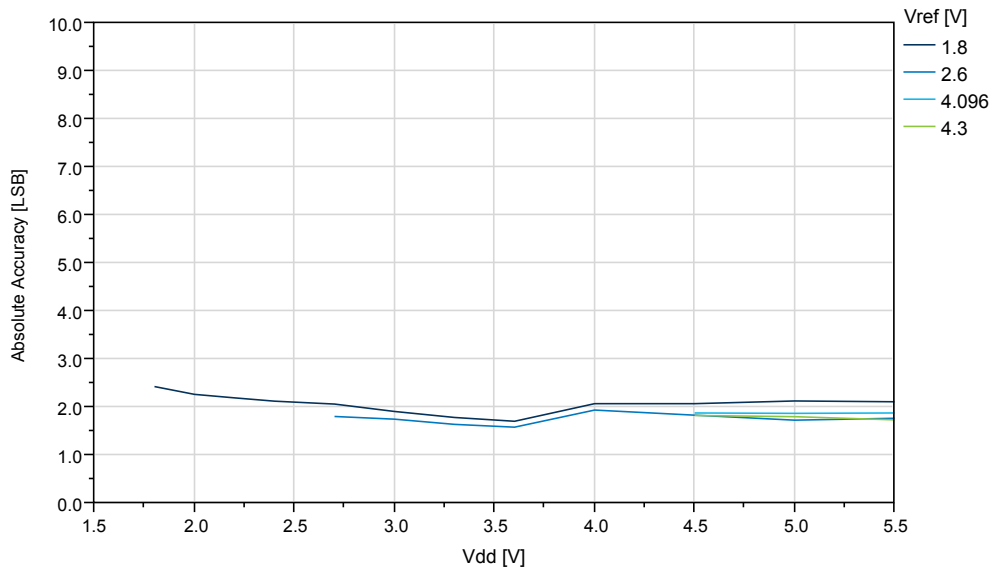

Figure 6-52. Absolute Accuracy vs. V_{DD} ($f_{ADC}=115$ kps, $T=25^{\circ}C$), REFSEL = External Reference



ATmega3209/4809 – 48-pin Data Sheet

Typical Characteristics

Figure 6-53. Absolute Accuracy vs. V_{REF} ($V_{DD}=5.0V$, $f_{ADC}=115$ ksp/s, REFSEL = External Reference)

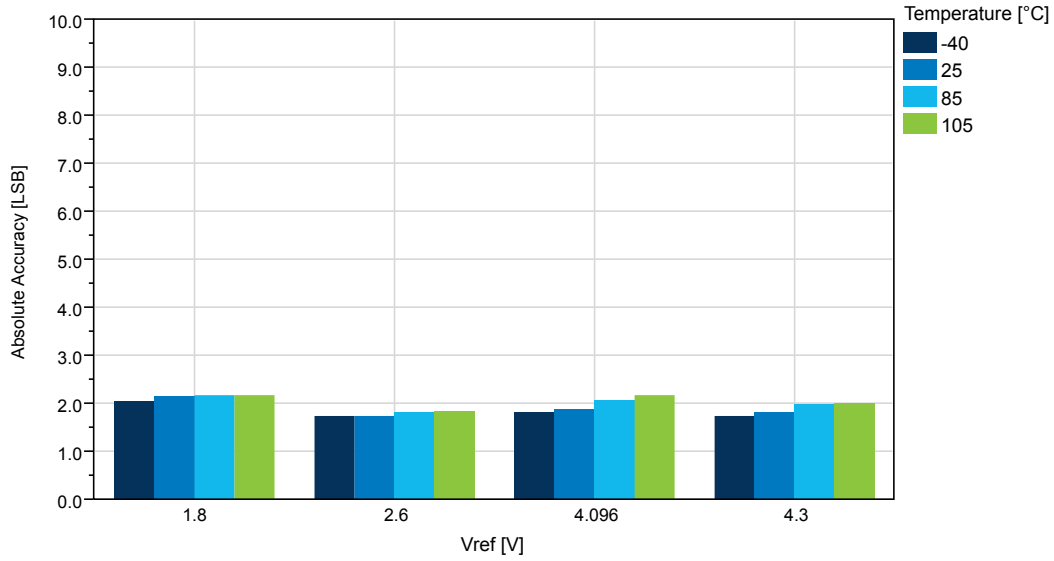
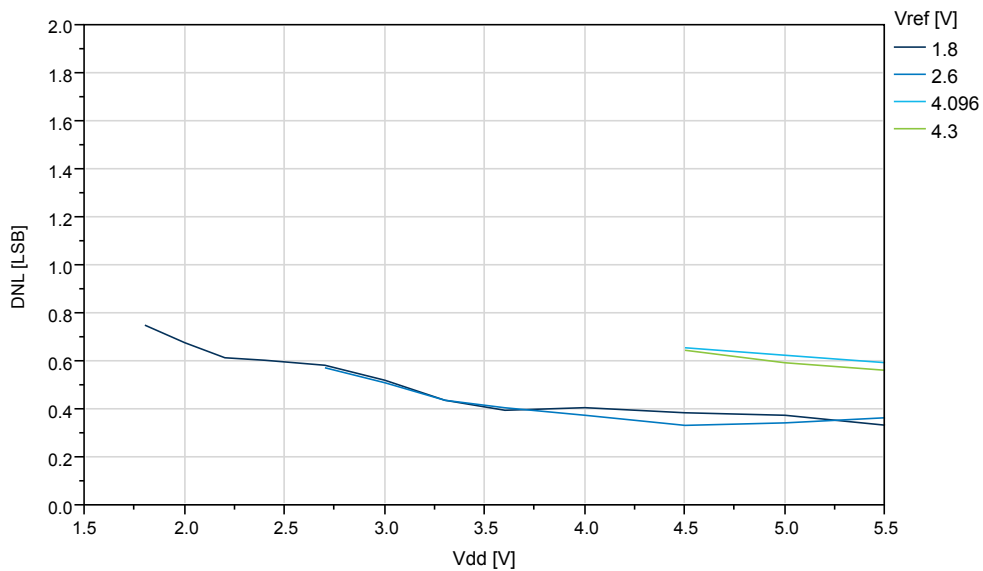

Figure 6-54. DNL vs. V_{DD} ($f_{ADC}=115$ ksp/s, $T=25^{\circ}C$, REFSEL = External Reference)



ATmega3209/4809 – 48-pin Data Sheet

Typical Characteristics

Figure 6-55. DNL vs. V_{REF} ($V_{DD}=5.0V$, $f_{ADC}=115$ ksp/s, REFSEL = External Reference)

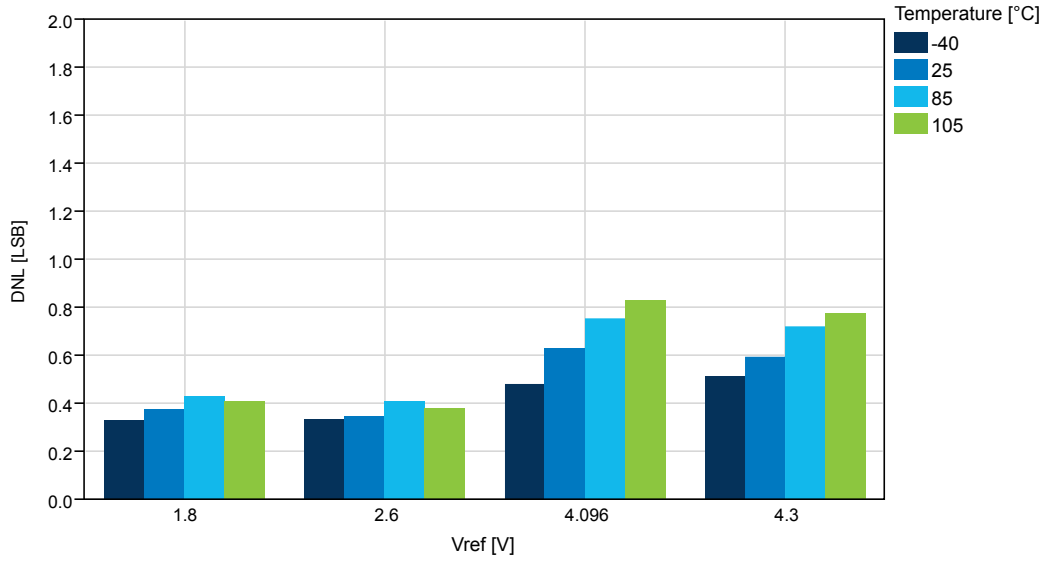
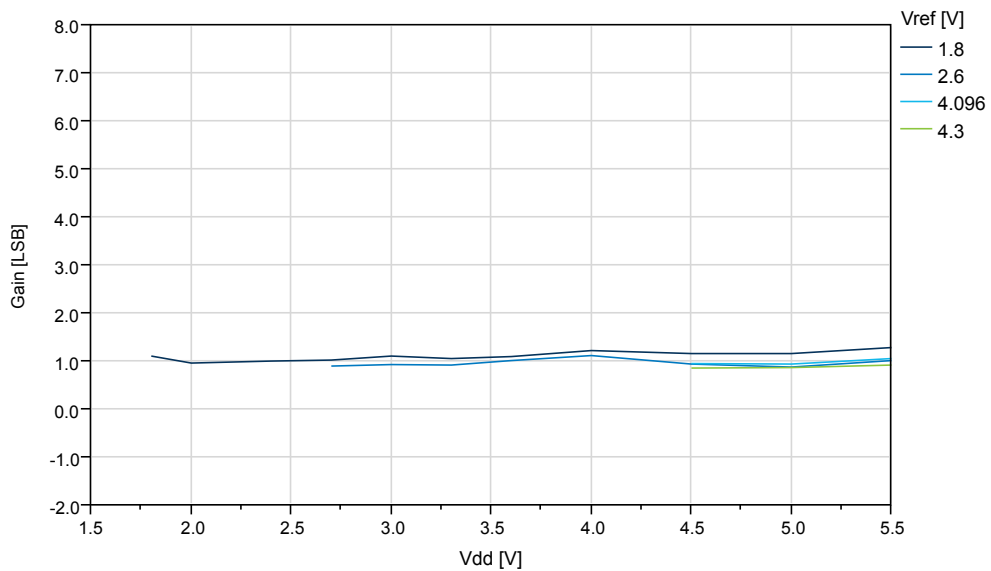

Figure 6-56. Gain vs. V_{DD} ($f_{ADC}=115$ ksp/s, $T=25^{\circ}C$, REFSEL = External Reference)



ATmega3209/4809 – 48-pin Data Sheet

Typical Characteristics

Figure 6-57. Gain vs. V_{REF} ($V_{DD}=5.0V$, $f_{ADC}=115$ ksp/s, REFSEL = External Reference)

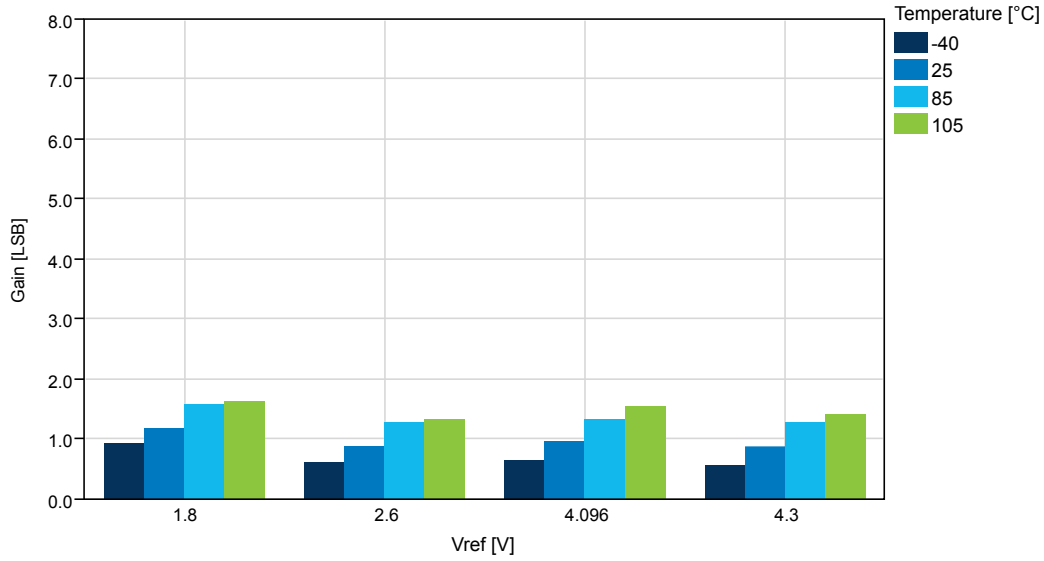
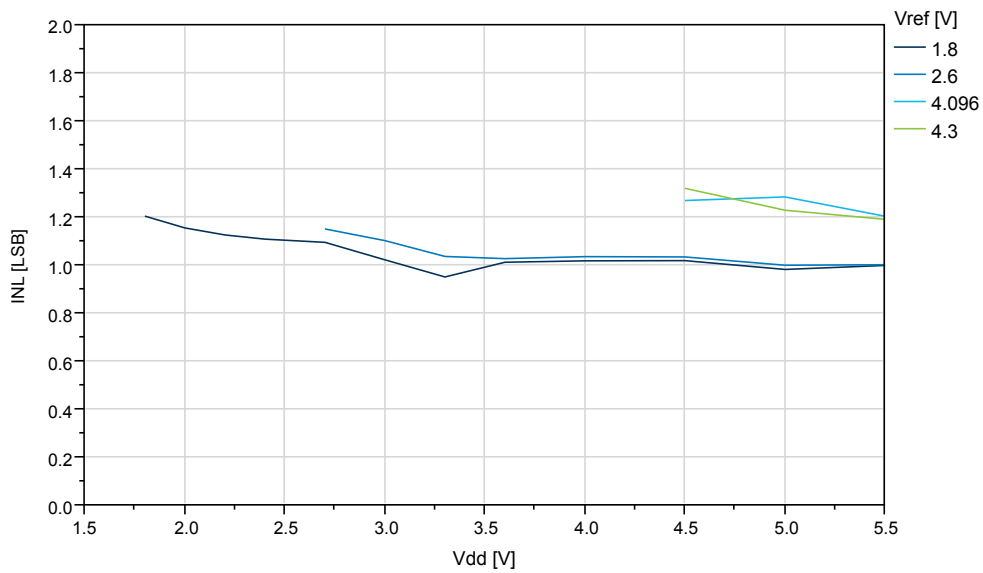

Figure 6-58. INL vs. V_{DD} ($f_{ADC}=115$ ksp/s, $T=25^{\circ}C$, REFSEL = External Reference)



ATmega3209/4809 – 48-pin Data Sheet

Typical Characteristics

Figure 6-59. INL vs. V_{REF} ($V_{DD}=5.0V$, $f_{ADC}=115$ kps, REFSEL = External Reference)

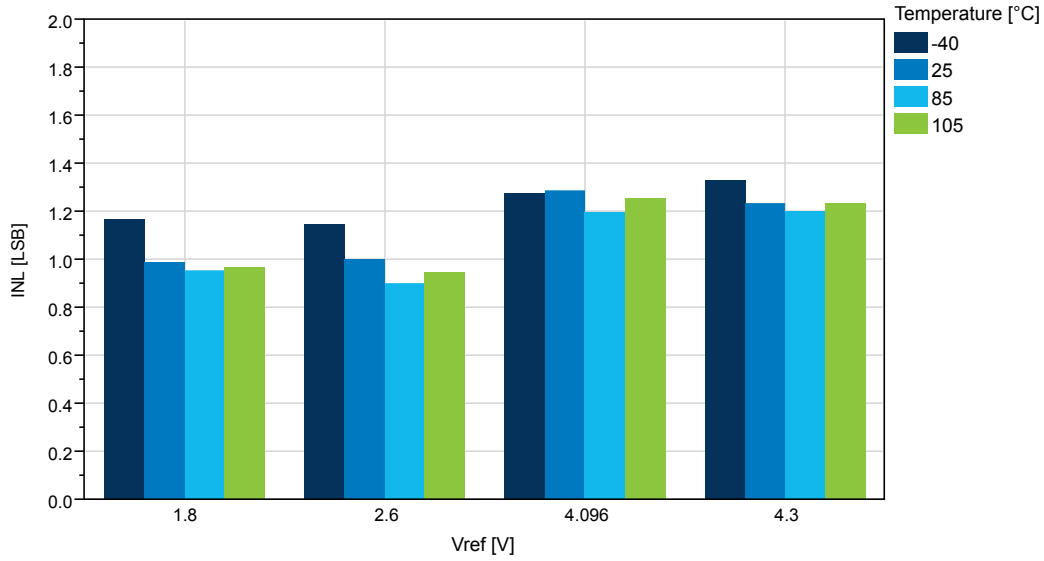

Figure 6-60. Offset vs. V_{DD} ($f_{ADC}=115$ kps, $T=25^{\circ}C$, REFSEL = External Reference)

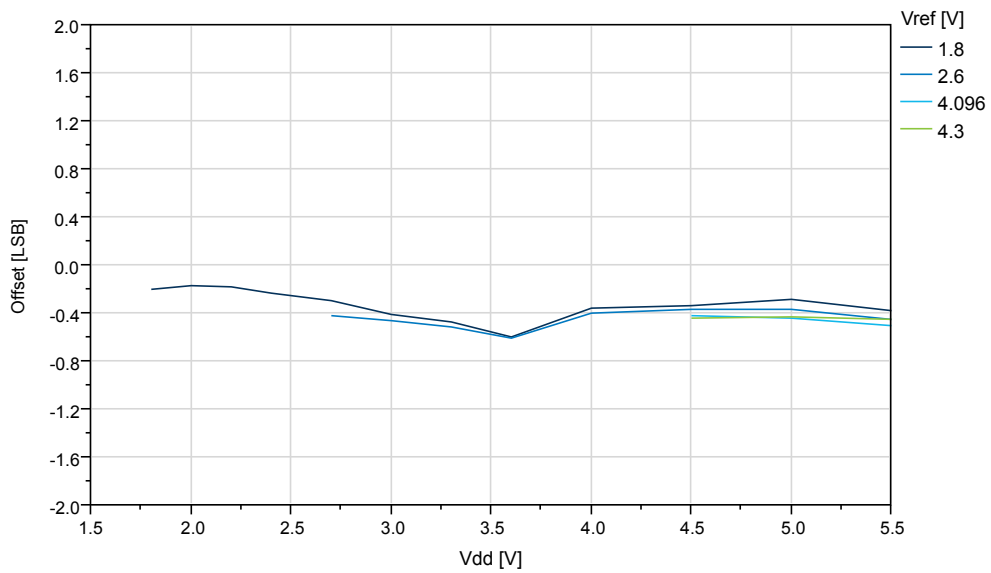
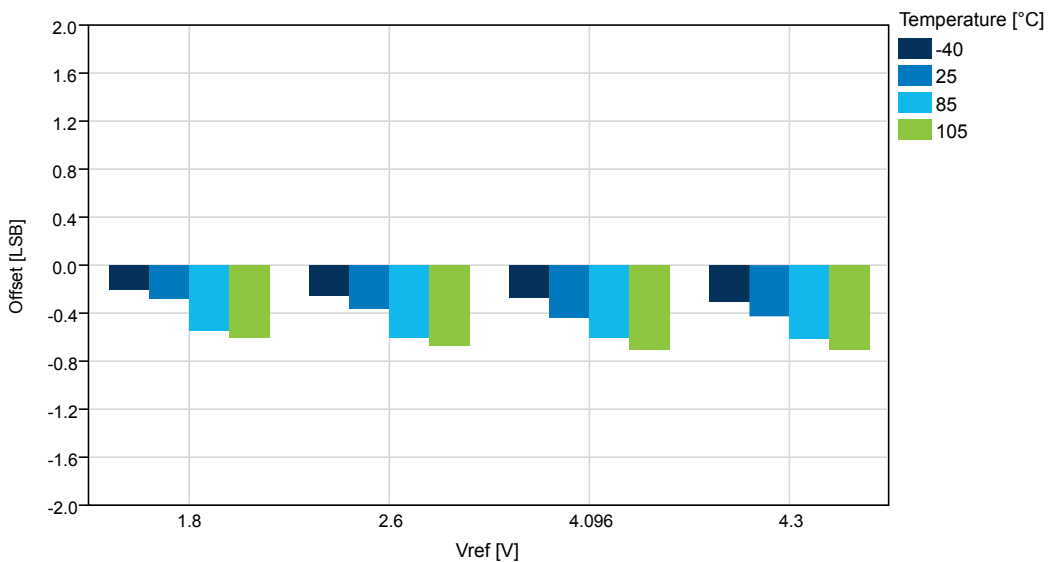
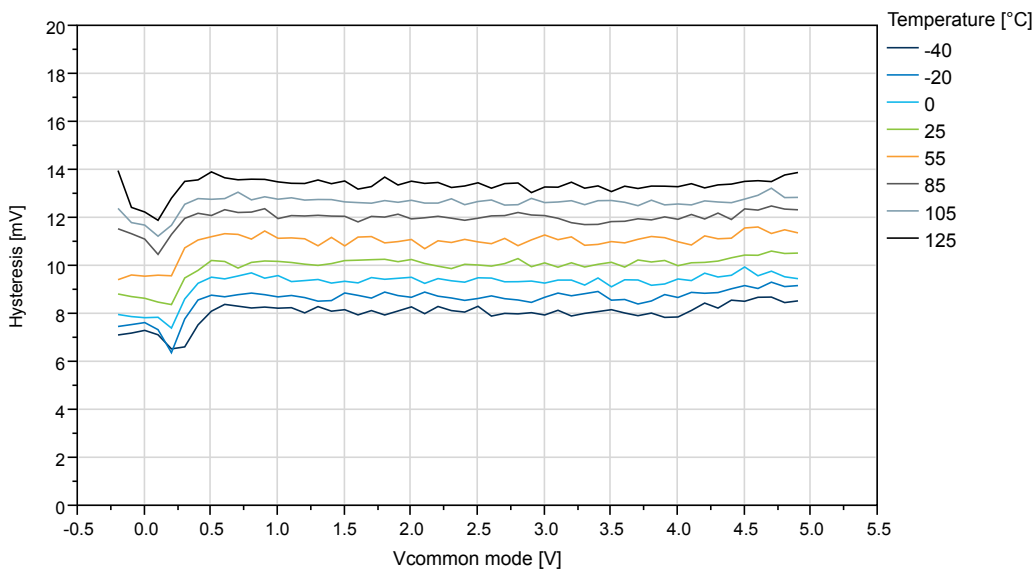

Figure 6-61. Offset vs. V_{REF} ($V_{DD}=5.0V$, $f_{ADC}=115$ ksp/s, REFSEL = External Reference)



6.6 AC Characteristics

Figure 6-62. Hysteresis vs. V_{CM} - 10 mV ($V_{DD}=5V$)



ATmega3209/4809 – 48-pin Data Sheet

Typical Characteristics

Figure 6-63. Hysteresis vs. V_{CM} - 10 mV to 50 mV ($V_{DD}=5V$, $T=25^{\circ}C$)

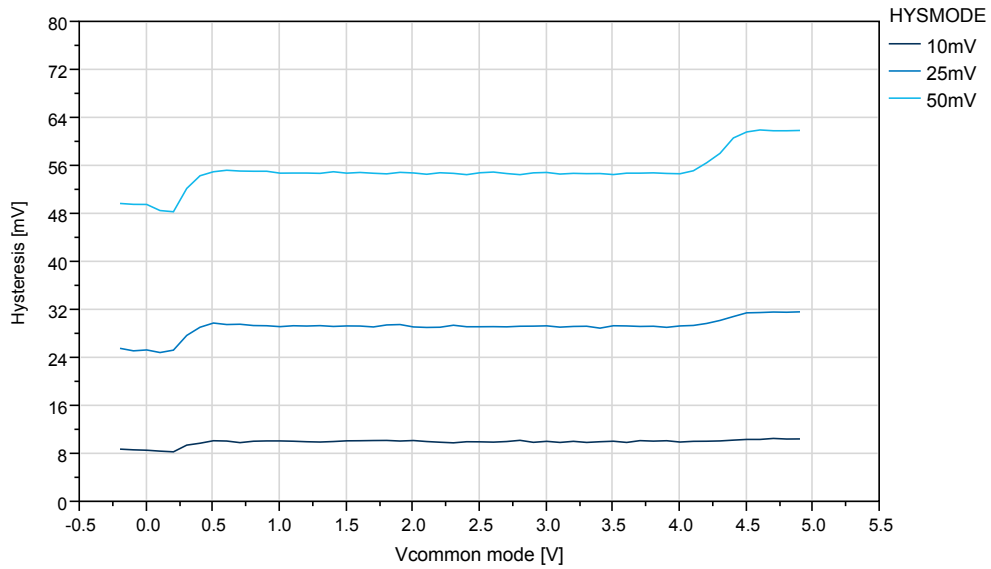

Figure 6-64. Offset vs. V_{CM} - 10 mV ($V_{DD}=5V$)

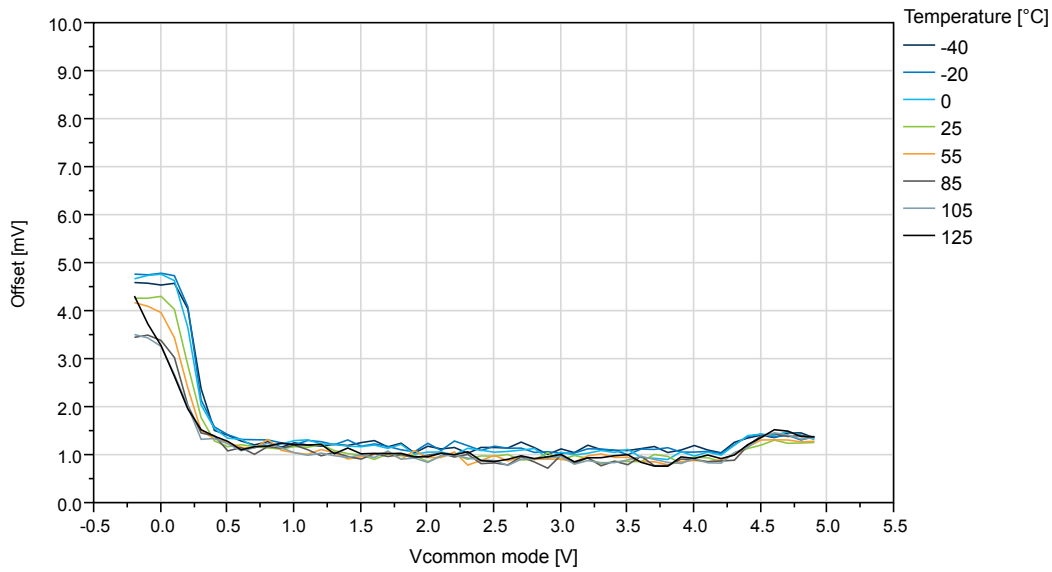
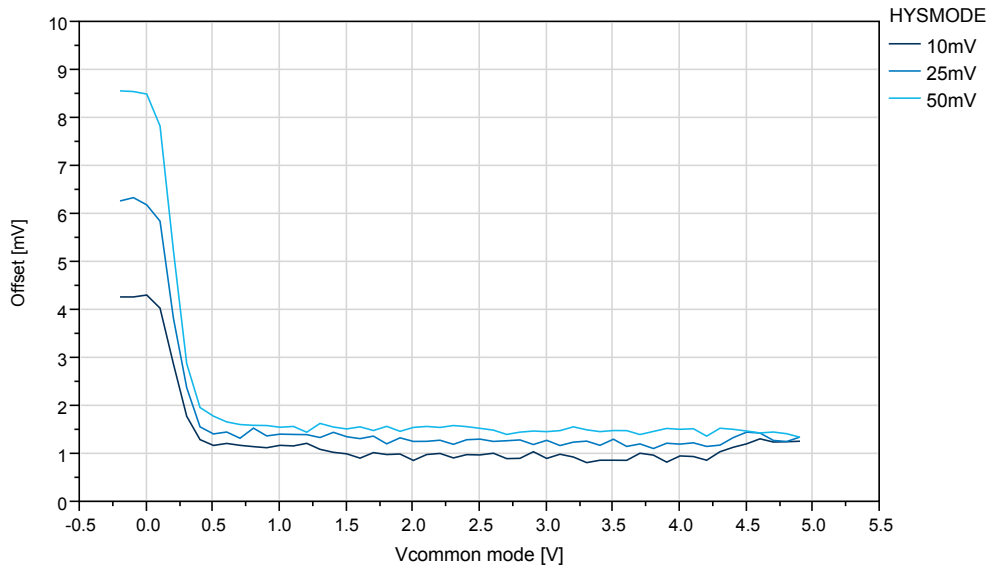
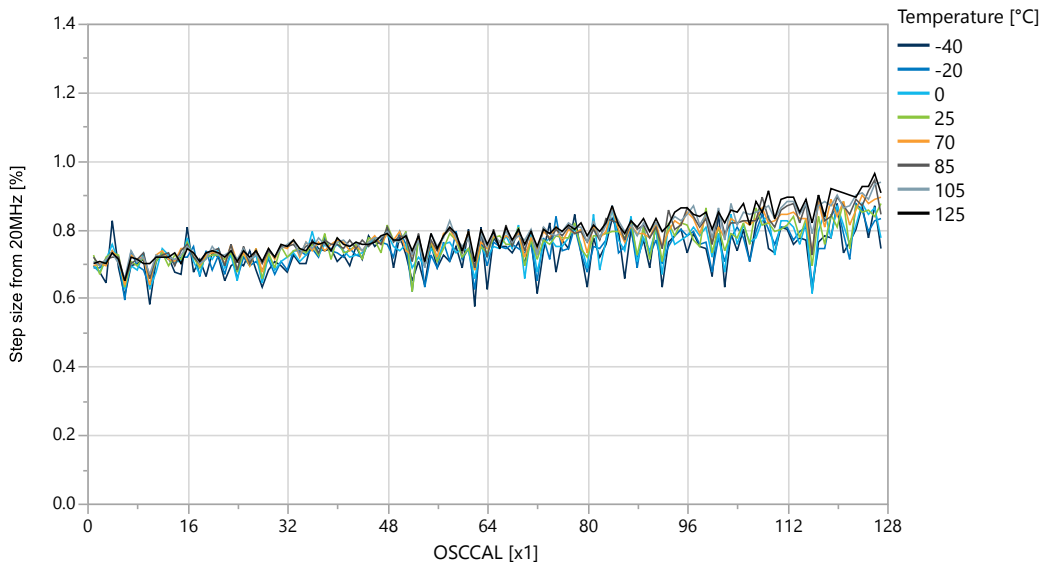

Figure 6-65. Offset vs. V_{CM} - 10 mV to 50 mV ($V_{DD}=5V$, $T=25^{\circ}C$)



6.7 OSC20M Characteristics

Figure 6-66. OSC20M Internal Oscillator: Calibration Stepsize vs. Calibration Value ($V_{DD}=3V$)



ATmega3209/4809 – 48-pin Data Sheet

Typical Characteristics

Figure 6-67. OSC20M Internal Oscillator: Frequency vs. Calibration Value ($V_{DD}=3V$)

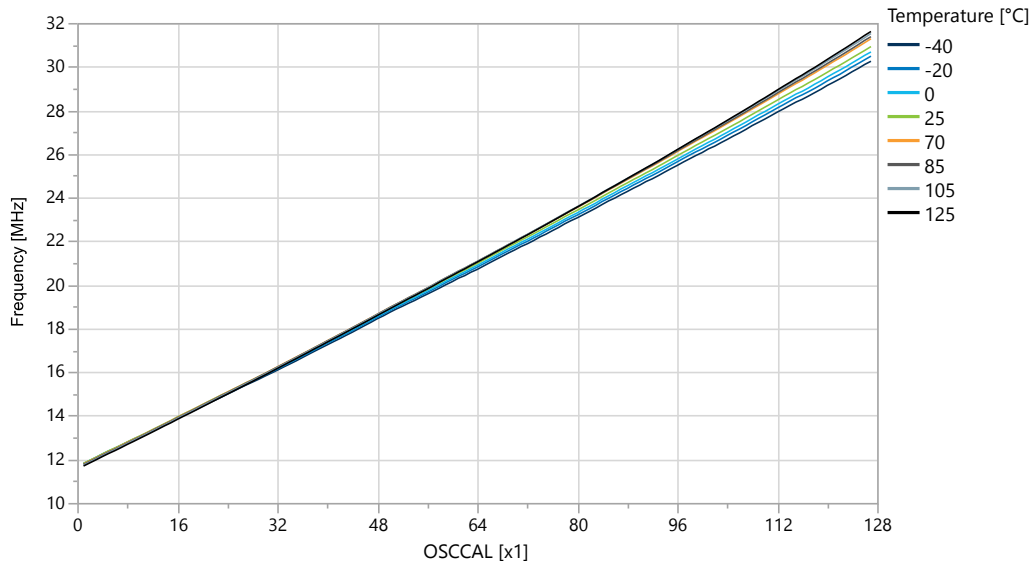

Figure 6-68. OSC20M Internal Oscillator: Frequency vs. Temperature

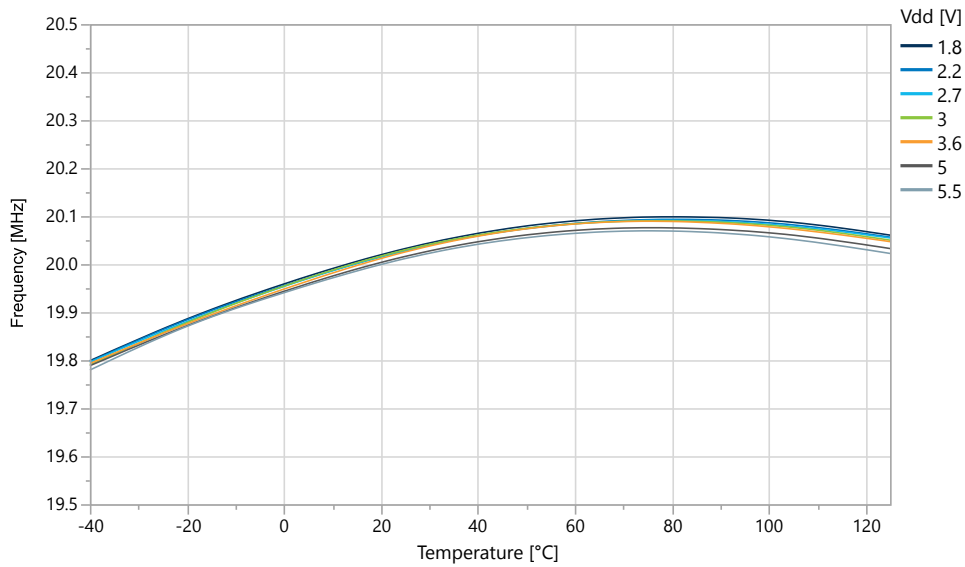
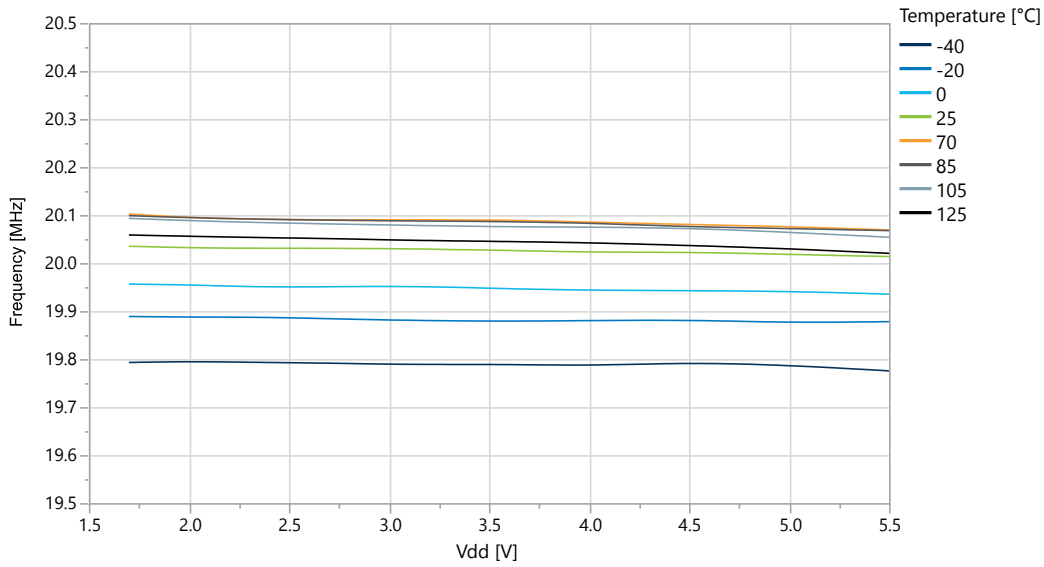
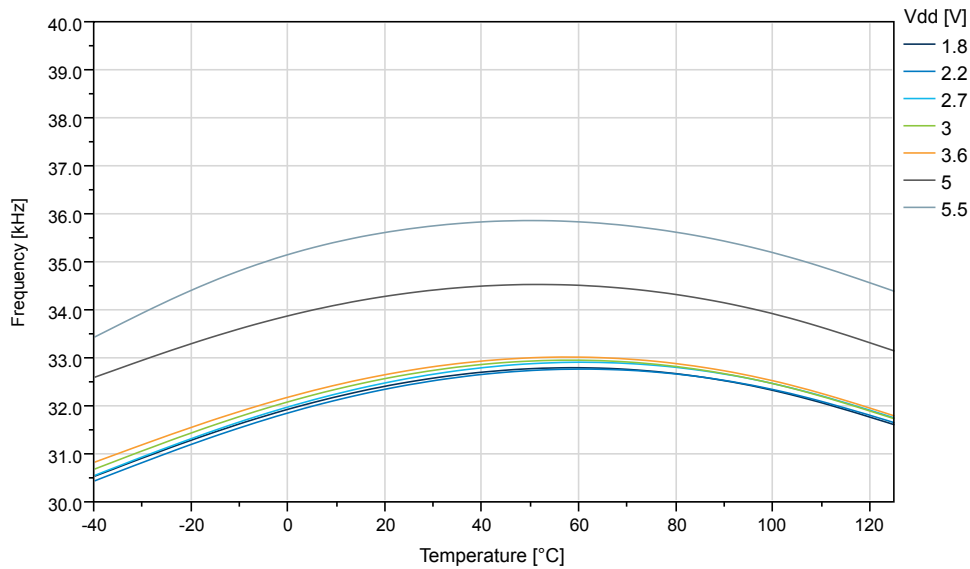

Figure 6-69. OSC20M Internal Oscillator: Frequency vs. V_{DD}



6.8 OSCULP32K Characteristics

Figure 6-70. OSCULP32K Internal Oscillator Frequency vs. Temperature



ATmega3209/4809 – 48-pin Data Sheet

Typical Characteristics

Figure 6-71. OSCULP32K Internal Oscillator Frequency vs. V_{DD}

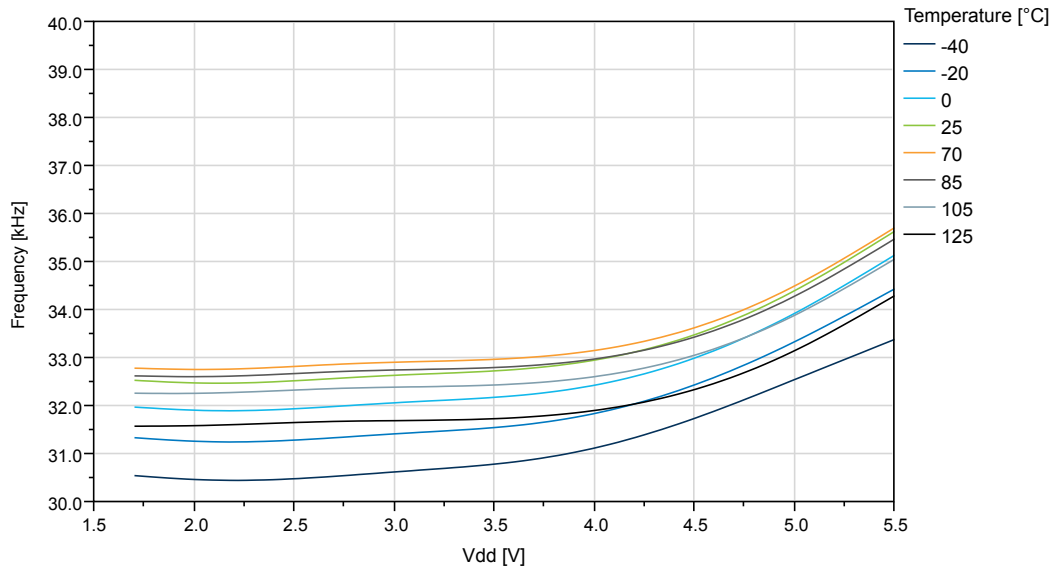

ATmega3209/4809 – 48-pin Data Sheet

Package Drawings

7. Package Drawings

7.1 48 pin TQFP

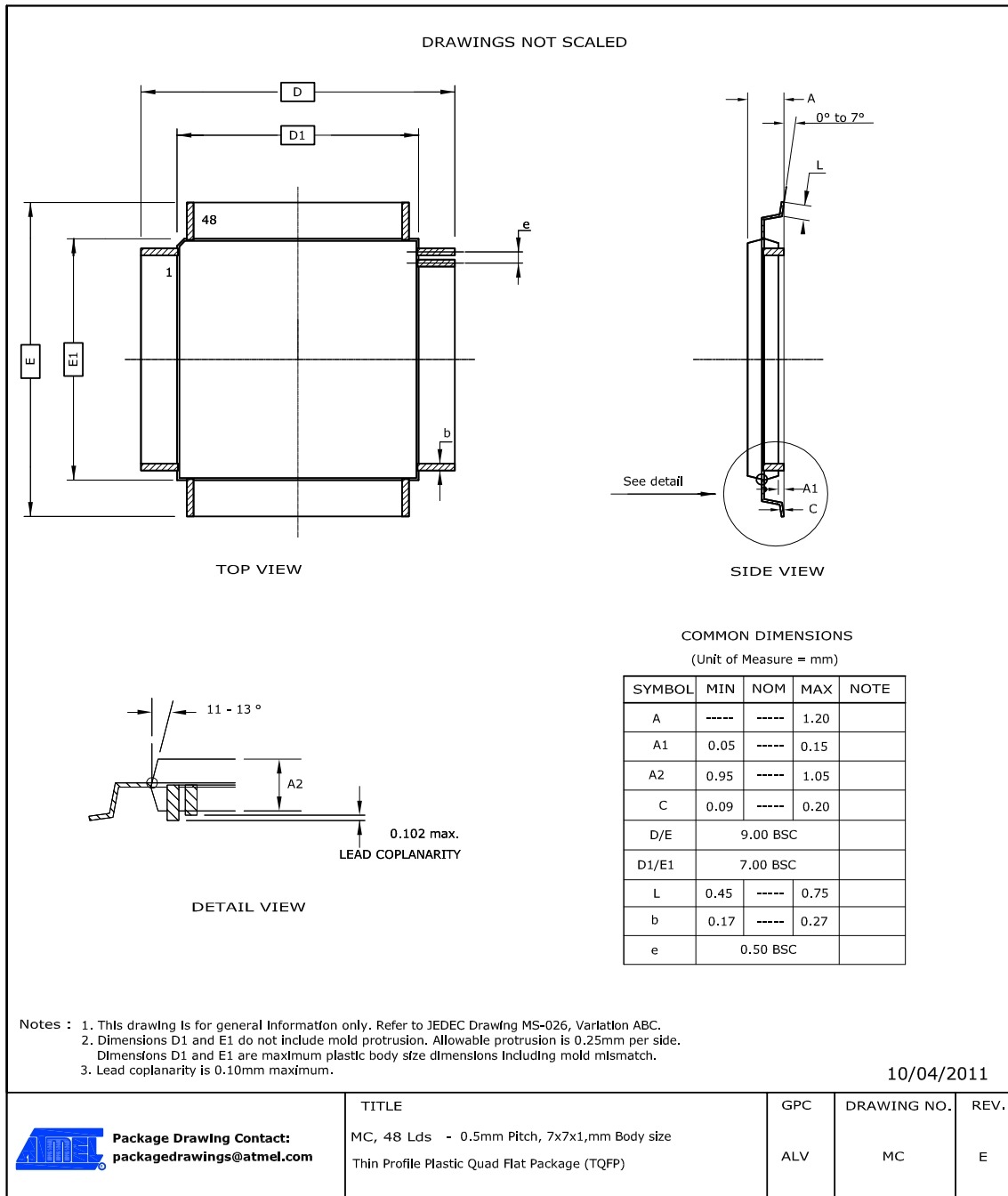

Table 7-1. Device and Package Maximum Weight

140	mg
-----	----

ATmega3209/4809 – 48-pin Data Sheet

Package Drawings

Table 7-2. Package Characteristics

Moisture Sensitivity Level	MSL3
----------------------------	------

Table 7-3. Package Reference

JEDEC Drawing Reference	MS-026
JESD97 Classification	E3

8. Conventions

8.1 Memory Size and Type

Table 8-1. Memory Size and Bit Rate

Symbol	Description
KB	kilobyte ($2^{10} = 1024$)
MB	megabyte ($2^{20} = 1024*1024$)
GB	gigabyte ($2^{30} = 1024*1024*1024$)
b	bit (binary '0' or '1')
B	byte (8 bits)
1 kbit/s	1,000 bit/s rate (not 1,024 bit/s)
1 Mbit/s	1,000,000 bit/s rate
1 Gbit/s	1,000,000,000 bit/s rate
word	16-bit

8.2 Frequency and Time

Table 8-2. Frequency and Time

Symbol	Description
kHz	1 kHz = 10^3 Hz = 1,000 Hz
KHz	1 KHz = 1,024 Hz, 32 KHz = 32,768 Hz
MHz	1 MHz = 10^6 Hz = 1,000,000 Hz
GHz	1 GHz = 10^9 Hz = 1,000,000,000 Hz
s	second
ms	millisecond
μs	microsecond
ns	nanosecond

9. Data Sheet Revision History

Note: The data sheet revision is independent of the die revision and the device variant (last letter of the ordering number).

9.1 Rev. A - 02/2018

Initial release.

The Microchip Web Site

Microchip provides online support via our web site at <http://www.microchip.com/>. This web site is used as a means to make files and information easily available to customers. Accessible by using your favorite Internet browser, the web site contains the following information:

- **Product Support** – Data sheets and errata, application notes and sample programs, design resources, user's guides and hardware support documents, latest software releases and archived software
- **General Technical Support** – Frequently Asked Questions (FAQ), technical support requests, online discussion groups, Microchip consultant program member listing
- **Business of Microchip** – Product selector and ordering guides, latest Microchip press releases, listing of seminars and events, listings of Microchip sales offices, distributors and factory representatives

Customer Change Notification Service

Microchip's customer notification service helps keep customers current on Microchip products. Subscribers will receive e-mail notification whenever there are changes, updates, revisions or errata related to a specified product family or development tool of interest.

To register, access the Microchip web site at <http://www.microchip.com/>. Under "Support", click on "Customer Change Notification" and follow the registration instructions.

Customer Support

Users of Microchip products can receive assistance through several channels:

- Distributor or Representative
- Local Sales Office
- Field Application Engineer (FAE)
- Technical Support

Customers should contact their distributor, representative or Field Application Engineer (FAE) for support. Local sales offices are also available to help customers. A listing of sales offices and locations is included in the back of this document.

Technical support is available through the web site at: <http://www.microchip.com/support>

ATmega3209/4809 – 48-pin Data Sheet

Product Identification System

To order or obtain information, e.g., on pricing or delivery, refer to the factory or the listed sales office.

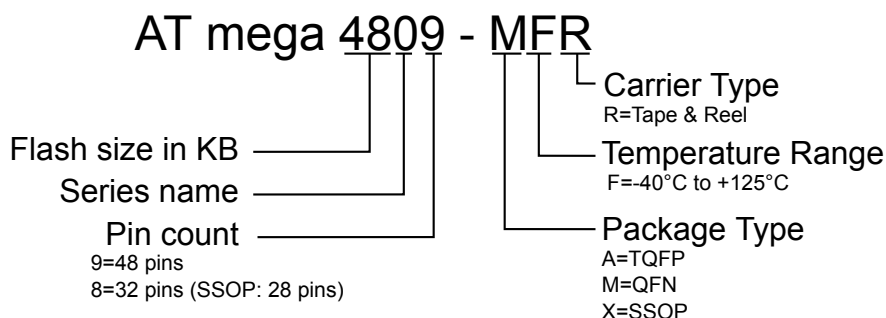

Note: Tape and Reel identifier only appears in the catalog part number description. This identifier is used for ordering purposes and is not printed on the device package. Check with your Microchip Sales Office for package availability with the Tape and Reel option.

Microchip Devices Code Protection Feature

Note the following details of the code protection feature on Microchip devices:

- Microchip products meet the specification contained in their particular Microchip Data Sheet.
- Microchip believes that its family of products is one of the most secure families of its kind on the market today, when used in the intended manner and under normal conditions.
- There are dishonest and possibly illegal methods used to breach the code protection feature. All of these methods, to our knowledge, require using the Microchip products in a manner outside the operating specifications contained in Microchip's Data Sheets. Most likely, the person doing so is engaged in theft of intellectual property.
- Microchip is willing to work with the customer who is concerned about the integrity of their code.
- Neither Microchip nor any other semiconductor manufacturer can guarantee the security of their code. Code protection does not mean that we are guaranteeing the product as "unbreakable."

Code protection is constantly evolving. We at Microchip are committed to continuously improving the code protection features of our products. Attempts to break Microchip's code protection feature may be a violation of the Digital Millennium Copyright Act. If such acts allow unauthorized access to your software or other copyrighted work, you may have a right to sue for relief under that Act.

Legal Notice

Information contained in this publication regarding device applications and the like is provided only for your convenience and may be superseded by updates. It is your responsibility to ensure that your application meets with your specifications. MICROCHIP MAKES NO REPRESENTATIONS OR WARRANTIES OF ANY KIND WHETHER EXPRESS OR IMPLIED, WRITTEN OR ORAL, STATUTORY OR OTHERWISE, RELATED TO THE INFORMATION, INCLUDING BUT NOT LIMITED TO ITS CONDITION, QUALITY, PERFORMANCE, MERCHANTABILITY OR FITNESS FOR PURPOSE. Microchip disclaims all liability arising from this information and its use. Use of Microchip devices in life support and/or safety applications is entirely at the buyer's risk, and the buyer agrees to defend, indemnify and hold harmless Microchip from any and all damages, claims, suits, or expenses resulting

from such use. No licenses are conveyed, implicitly or otherwise, under any Microchip intellectual property rights unless otherwise stated.

Trademarks

The Microchip name and logo, the Microchip logo, AnyRate, AVR, AVR logo, AVR Freaks, BeaconThings, BitCloud, CryptoMemory, CryptoRF, dsPIC, FlashFlex, flexPWR, Heldo, JukeBlox, KeeLoq, KeeLoq logo, Klear, LANCheck, LINK MD, maXStylus, maXTouch, MediaLB, megaAVR, MOST, MOST logo, MPLAB, OptoLyzer, PIC, picoPower, PICSTART, PIC32 logo, Prochip Designer, QTouch, RightTouch, SAM-BA, SpyNIC, SST, SST Logo, SuperFlash, tinyAVR, UNI/O, and XMEGA are registered trademarks of Microchip Technology Incorporated in the U.S.A. and other countries.

ClockWorks, The Embedded Control Solutions Company, EtherSynch, Hyper Speed Control, HyperLight Load, IntelliMOS, mTouch, Precision Edge, and Quiet-Wire are registered trademarks of Microchip Technology Incorporated in the U.S.A.

Adjacent Key Suppression, AKS, Analog-for-the-Digital Age, Any Capacitor, AnyIn, AnyOut, BodyCom, chipKIT, chipKIT logo, CodeGuard, CryptoAuthentication, CryptoCompanion, CryptoController, dsPICDEM, dsPICDEM.net, Dynamic Average Matching, DAM, ECAN, EtherGREEN, In-Circuit Serial Programming, ICSP, Inter-Chip Connectivity, JitterBlocker, KlearNet, KlearNet logo, Mindi, MiWi, motorBench, MPASM, MPF, MPLAB Certified logo, MPLIB, MPLINK, MultiTRAK, NetDetach, Omniscient Code Generation, PICDEM, PICDEM.net, PICkit, PICtail, PureSilicon, QMatrix, RightTouch logo, REAL ICE, Ripple Blocker, SAM-ICE, Serial Quad I/O, SMART-I.S., SQI, SuperSwitcher, SuperSwitcher II, Total Endurance, TSHARC, USBCheck, VariSense, ViewSpan, WiperLock, Wireless DNA, and ZENA are trademarks of Microchip Technology Incorporated in the U.S.A. and other countries.

SQTP is a service mark of Microchip Technology Incorporated in the U.S.A.

Silicon Storage Technology is a registered trademark of Microchip Technology Inc. in other countries.

GestIC is a registered trademark of Microchip Technology Germany II GmbH & Co. KG, a subsidiary of Microchip Technology Inc., in other countries.

All other trademarks mentioned herein are property of their respective companies.

© 2018, Microchip Technology Incorporated, Printed in the U.S.A., All Rights Reserved.

ISBN: 978-1-5224-2713-1

Quality Management System Certified by DNV

ISO/TS 16949

Microchip received ISO/TS-16949:2009 certification for its worldwide headquarters, design and wafer fabrication facilities in Chandler and Tempe, Arizona; Gresham, Oregon and design centers in California and India. The Company's quality system processes and procedures are for its PIC[®] MCUs and dsPIC[®] DSCs, KEELOQ[®] code hopping devices, Serial EEPROMs, microperipherals, nonvolatile memory and analog products. In addition, Microchip's quality system for the design and manufacture of development systems is ISO 9001:2000 certified.

Worldwide Sales and Service

AMERICAS	ASIA/PACIFIC	ASIA/PACIFIC	EUROPE
<p>Corporate Office 2355 West Chandler Blvd. Chandler, AZ 85224-6199 Tel: 480-792-7200 Fax: 480-792-7277 Technical Support: http://www.microchip.com/support Web Address: www.microchip.com</p> <p>Atlanta Duluth, GA Tel: 678-957-9614 Fax: 678-957-1455</p> <p>Austin, TX Tel: 512-257-3370</p> <p>Boston Westborough, MA Tel: 774-760-0087 Fax: 774-760-0088</p> <p>Chicago Itasca, IL Tel: 630-285-0071 Fax: 630-285-0075</p> <p>Dallas Addison, TX Tel: 972-818-7423 Fax: 972-818-2924</p> <p>Detroit Novi, MI Tel: 248-848-4000</p> <p>Houston, TX Tel: 281-894-5983</p> <p>Indianapolis Noblesville, IN Tel: 317-773-8323 Fax: 317-773-5453 Tel: 317-536-2380</p> <p>Los Angeles Mission Viejo, CA Tel: 949-462-9523 Fax: 949-462-9608 Tel: 951-273-7800</p> <p>Raleigh, NC Tel: 919-844-7510</p> <p>New York, NY Tel: 631-435-6000</p> <p>San Jose, CA Tel: 408-735-9110 Tel: 408-436-4270</p> <p>Canada - Toronto Tel: 905-695-1980 Fax: 905-695-2078</p>	<p>Australia - Sydney Tel: 61-2-9868-6733</p> <p>China - Beijing Tel: 86-10-8569-7000</p> <p>China - Chengdu Tel: 86-28-8665-5511</p> <p>China - Chongqing Tel: 86-23-8980-9588</p> <p>China - Dongguan Tel: 86-769-8702-9880</p> <p>China - Guangzhou Tel: 86-20-8755-8029</p> <p>China - Hangzhou Tel: 86-571-8792-8115</p> <p>China - Hong Kong SAR Tel: 852-2943-5100</p> <p>China - Nanjing Tel: 86-25-8473-2460</p> <p>China - Qingdao Tel: 86-532-8502-7355</p> <p>China - Shanghai Tel: 86-21-3326-8000</p> <p>China - Shenyang Tel: 86-24-2334-2829</p> <p>China - Shenzhen Tel: 86-755-8864-2200</p> <p>China - Suzhou Tel: 86-186-6233-1526</p> <p>China - Wuhan Tel: 86-27-5980-5300</p> <p>China - Xian Tel: 86-29-8833-7252</p> <p>China - Xiamen Tel: 86-592-2388138</p> <p>China - Zhuhai Tel: 86-756-3210040</p>	<p>India - Bangalore Tel: 91-80-3090-4444</p> <p>India - New Delhi Tel: 91-11-4160-8631</p> <p>India - Pune Tel: 91-20-4121-0141</p> <p>Japan - Osaka Tel: 81-6-6152-7160</p> <p>Japan - Tokyo Tel: 81-3-6880-3770</p> <p>Korea - Daegu Tel: 82-53-744-4301</p> <p>Korea - Seoul Tel: 82-2-554-7200</p> <p>Malaysia - Kuala Lumpur Tel: 60-3-7651-7906</p> <p>Malaysia - Penang Tel: 60-4-227-8870</p> <p>Philippines - Manila Tel: 63-2-634-9065</p> <p>Singapore Tel: 65-6334-8870</p> <p>Taiwan - Hsin Chu Tel: 886-3-577-8366</p> <p>Taiwan - Kaohsiung Tel: 886-7-213-7830</p> <p>Taiwan - Taipei Tel: 886-2-2508-8600</p> <p>Thailand - Bangkok Tel: 66-2-694-1351</p> <p>Vietnam - Ho Chi Minh Tel: 84-28-5448-2100</p>	<p>Austria - Wels Tel: 43-7242-2244-39 Fax: 43-7242-2244-393</p> <p>Denmark - Copenhagen Tel: 45-4450-2828 Fax: 45-4485-2829</p> <p>Finland - Espoo Tel: 358-9-4520-820</p> <p>France - Paris Tel: 33-1-69-53-63-20 Fax: 33-1-69-30-90-79</p> <p>Germany - Garching Tel: 49-8931-9700</p> <p>Germany - Haan Tel: 49-2129-3766400</p> <p>Germany - Heilbronn Tel: 49-7131-67-3636</p> <p>Germany - Karlsruhe Tel: 49-721-625370</p> <p>Germany - Munich Tel: 49-89-627-144-0 Fax: 49-89-627-144-44</p> <p>Germany - Rosenheim Tel: 49-8031-354-560</p> <p>Israel - Ra'anana Tel: 972-9-744-7705</p> <p>Italy - Milan Tel: 39-0331-742611 Fax: 39-0331-466781</p> <p>Italy - Padova Tel: 39-049-7625286</p> <p>Netherlands - Drunen Tel: 31-416-690399 Fax: 31-416-690340</p> <p>Norway - Trondheim Tel: 47-7289-7561</p> <p>Poland - Warsaw Tel: 48-22-3325737</p> <p>Romania - Bucharest Tel: 40-21-407-87-50</p> <p>Spain - Madrid Tel: 34-91-708-08-90 Fax: 34-91-708-08-91</p> <p>Sweden - Gothenberg Tel: 46-31-704-60-40</p> <p>Sweden - Stockholm Tel: 46-8-5090-4654</p> <p>UK - Wokingham Tel: 44-118-921-5800 Fax: 44-118-921-5820</p>

Mouser Electronics

Authorized Distributor

Click to View Pricing, Inventory, Delivery & Lifecycle Information:

[Microchip:](#)

[ATMEGA4809-AFR](#) [ATMEGA3209-MFR](#) [ATMEGA3209-AFR](#) [ATMEGA4809-MFR](#)