

Preliminary Data

- V_{CE} 1000 V
- I_C 2.5 A
- N channel
- MOS input (voltage-controlled)
- High switch speed
- Very low tail current
- Latch-up free
- Suitable freewheeling diode BAX 280

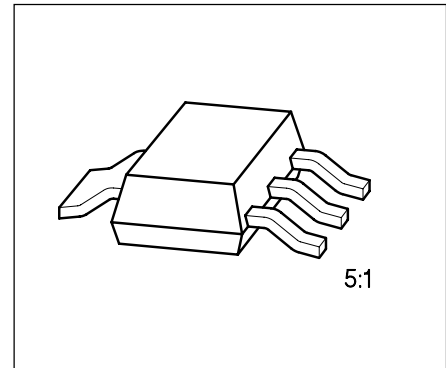

Type	Ordering Code	Tape and Reel Information	Pin Configuration				Marking	Package
			1	2	3	4		
BSP 280	Q67000-S279	E6327: 1000 pcs/reel	G	C	E	C	BSP 280	SOT-223

Maximum Ratings

Parameter	Symbol	Values	Unit
Continuous collector current	I_C	2.5 1.5	A
Soldering point, $T_S = 25\text{ °C}$			
$T_S = 80\text{ °C}$			
Continuous collector current ambient, $T_A = 80\text{ °C}$	I_C	0.5	
Pulsed collector current	$I_{C\text{ puls}}$	3.0	
Soldering point, $T_S = 80\text{ °C}$			
Collector-emitter voltage	V_{CE}	1000	V
Gate-emitter voltage	V_{GE}	± 20	
Power dissipation	P_{tot}	10 1.8	W
Soldering point, $T_S = 80\text{ °C}$			
Ambient $T_A = 25\text{ °C}$			
Operating and storage temperature range	T_j, T_{stg}	- 40 ... + 150	°C
Thermal resistance ¹⁾	chip-ambient R_{thJA} chip-soldering point R_{thJS}	70 6	K/W
DIN humidity category, DIN 40 040	–	E	–
IEC climatic category, DIN IEC 68-1	–	40/150/56	

IGBT = Insulated Gate Bipolar Transistor

¹⁾ Transistor on epoxy pcb 40 mm × 40 mm × 1.5 mm with 6 cm² copper area for drain connection.

Electrical Characteristics

at $T_j = 25\text{ °C}$, unless otherwise specified.

Parameter	Symbol	Values			Unit
		min.	typ.	max.	

Static Characteristics

Collector-emitter breakdown voltage $V_{GE} = 0, I_C = 0.1\text{ mA}$	$V_{(BR)CES}$	1000	–	–	V
Gate threshold voltage $V_{GE} = V_{CE}, I_C = 0.1\text{ mA}$	$V_{GE(th)}$	4.5	5.5	6.5	
Collector-emitter saturation voltage $V_{GE} = 15\text{ V}, I_C = 0.5\text{ A}$ $T_j = 25\text{ °C}$ $T_j = 125\text{ °C}$ $T_j = 150\text{ °C}$	$V_{CE(sat)}$	–	1.8	–	
$V_{GE} = 15\text{ V}, I_C = 1.5\text{ A}$ $T_j = 25\text{ °C}$ $T_j = 125\text{ °C}$ $T_j = 150\text{ °C}$		–	2.1	–	
		–	2.2	3.0	
		–	2.8	3.3	
		–	3.8	4.3	
		–	4.0	4.5	
Zero gate voltage collector current $V_{CE} = 1000\text{ V}, V_{GE} = 0$ $T_j = 25\text{ °C}$ $T_j = 125\text{ °C}$	I_{CES}	–	1	25	μA
		–	–	100	
Gate-emitter leakage current $V_{GE} = 20\text{ V}, V_{CE} = 0$	I_{GES}	–	0.1	100	nA

Dynamic Characteristics

Forward transconductance $V_{CE} = 20\text{ V}, I_C = 1.5\text{ A}$	g_{fs}	–	0.6	–	S
Input capacitance $V_{CE} = 0, V_{GE} = 25\text{ V}, f = 1\text{ MHz}$	C_{iss}	–	225	–	pF
Output capacitance $V_{CE} = 0, V_{GE} = 25\text{ V}, f = 1\text{ MHz}$	C_{oss}	–	25	–	
Reverse transfer capacitance $V_{CE} = 0, V_{GE} = 25\text{ V}, f = 1\text{ MHz}$	C_{rss}	–	13	–	
Turn-on delay time $V_{CC} = 600\text{ V}, V_{GE} = 15\text{ V}, R_{G(on)} = 25\text{ }\Omega, I_C = 1.5\text{ A}$	$t_{d(on)}$	–	20	–	ns
Rise time $V_{CC} = 600\text{ V}, V_{GE} = 15\text{ V}, R_{G(on)} = 25\text{ }\Omega, I_C = 1.5\text{ A}$	t_r	–	15	–	

Electrical Characteristics (cont'd)

at $T_j = 25\text{ }^\circ\text{C}$, unless otherwise specified.

Parameter	Symbol	Values			Unit
		min.	typ.	max.	
Turn-on losses $V_{CC} = 600\text{ V}$, $V_{GE} = 15\text{ V}$, $R_{G(off)} = 25\text{ }\Omega$, $I_C = 1.5\text{ A}$	E_{on}	–	0.3	–	mWs
Turn-off delay time $V_{CC} = 600\text{ V}$, $V_{GE} = 15\text{ V}$, $R_{G(off)} = 25\text{ }\Omega$, $I_C = 1.5\text{ A}$	$t_{d(off)}$	–	120	–	ns
Fall time $V_{CC} = 600\text{ V}$, $V_{GE} = 15\text{ V}$, $R_{G(off)} = 25\text{ }\Omega$, $I_C = 1.5\text{ A}$	t_f	–	20	–	
Total turn-off losses $V_{CC} = 600\text{ V}$, $V_{GE} = 15\text{ V}$, $R_{G(off)} = 25\text{ }\Omega$, $I_C = 1.5\text{ A}$	E_{off}	–	0.2	–	mWs

Package Outline

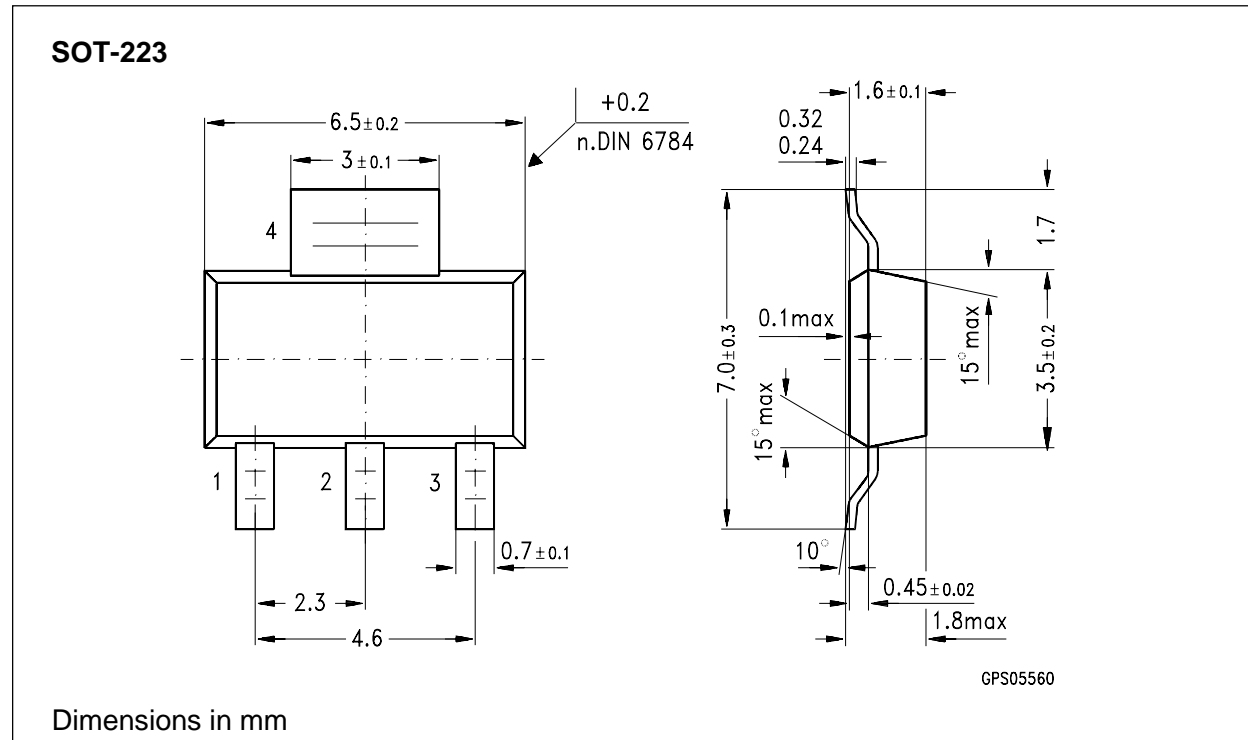

Characteristics
at $T_j = 25\text{ }^\circ\text{C}$, unless otherwise specified.

Typ. output characteristics $I_C = f(V_{CE})$
parameter: $t_p = 80\text{ }\mu\text{s}$

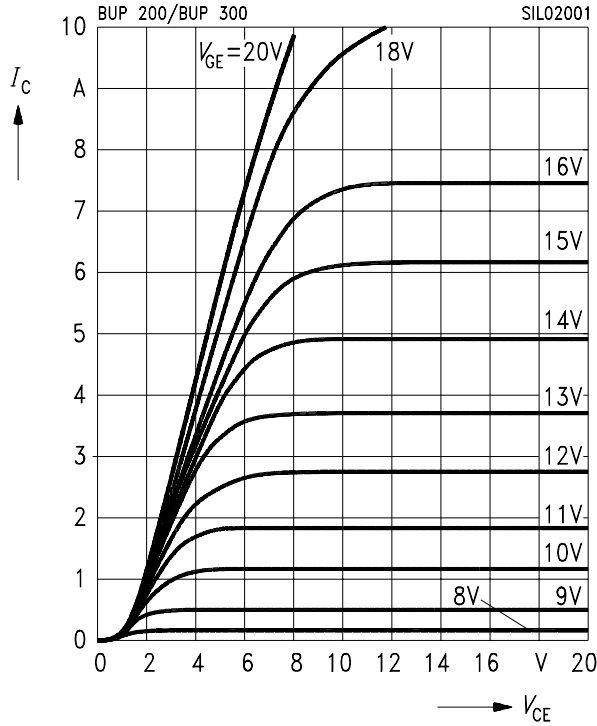

Typ. transfer characteristics $I_C = f(V_{GE})$
parameter: $t_p = 80\text{ }\mu\text{s}$, $V_{CE} = 20\text{ V}$

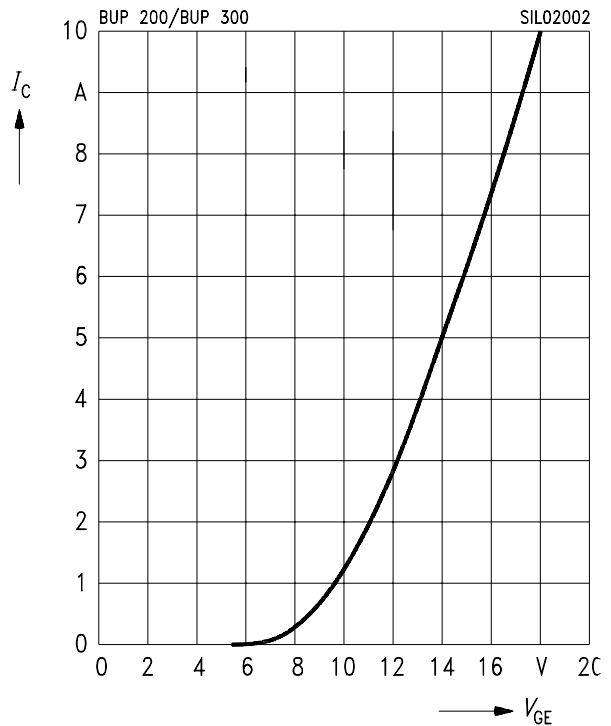

Typ. capacitances $C = f(V_{CE})$
parameter: $V_{GE} = 0\text{ V}$, $f = 1\text{ MHz}$

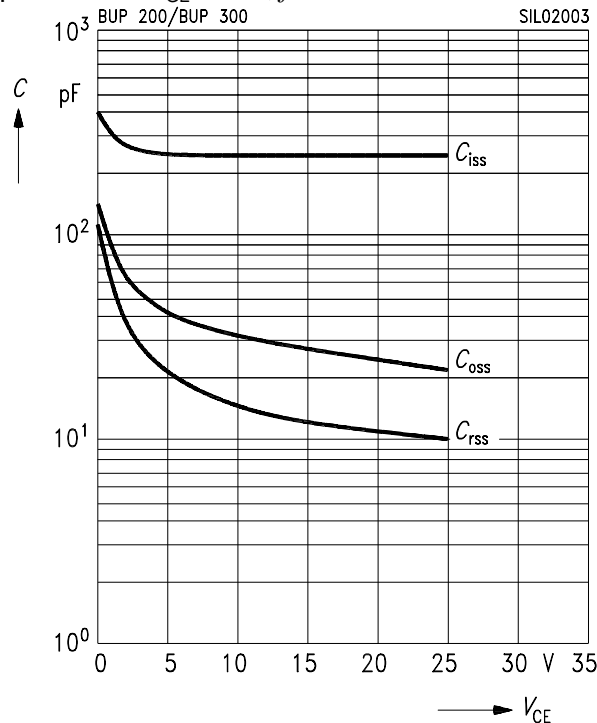

Typ. saturation characteristics
 $V_{CE(sat)} = f(V_{GE})$; parameter: $T_j = 25\text{ }^\circ\text{C}$

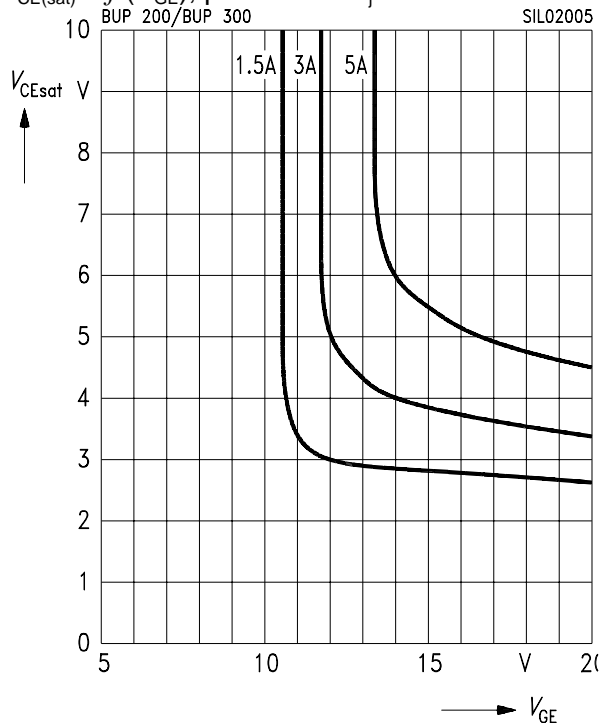

Typ. saturation characteristic

$V_{CE(sat)} = f(V_{GE})$; parameter: $T_j = 125\text{ °C}$

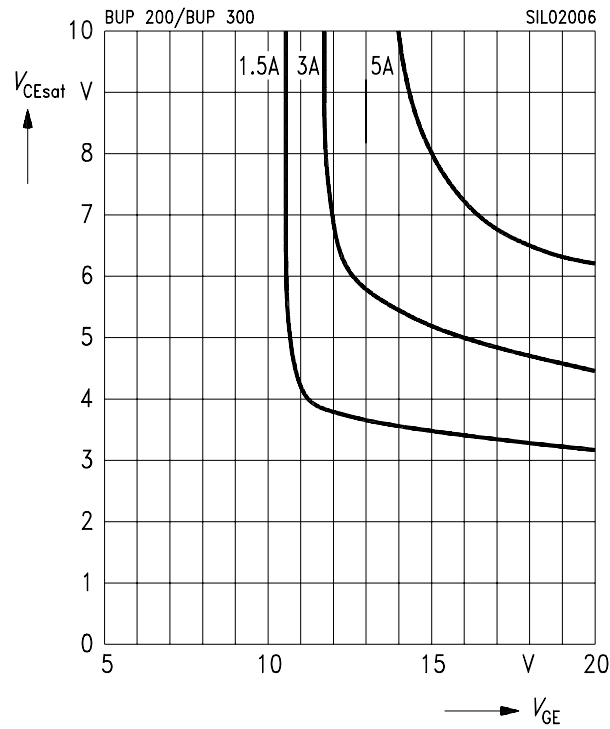

Typ. gate charge $V_{GE} = f(Q_{Gate})$

parameter: $I_{C plus} = 1\text{ A}$

