

FEATURES

- Very low offset voltage**
125 μV maximum
- Supply current: 215 μA /amp typical**
- Input bias current: 200 pA maximum**
- Low input offset voltage drift: 1.2 $\mu\text{V}/^\circ\text{C}$ maximum**
- Very low voltage noise: 11 $\text{nV}/\sqrt{\text{Hz}}$**
- Operating temperature: -40°C to $+125^\circ\text{C}$**
- Rail-to-rail output swing**
- Unity gain stable**
- $\pm 2.5\text{ V}$ to $\pm 15\text{ V}$ operation**

APPLICATIONS

- Portable precision instrumentation
- Laser diode control loops
- Strain gage amplifiers
- Medical instrumentation
- Thermocouple amplifiers

GENERAL DESCRIPTION

The AD8622 is a dual, precision rail-to-rail output operational amplifier with a low supply current of only 350 μA maximum over temperature and supply voltages. It also offers ultralow offset, drift, and voltage noise combined with very low input bias current over the full operating temperature range.

With typical offset voltage of only 10 μV , offset drift of 0.5 $\mu\text{V}/^\circ\text{C}$, and noise of only 0.2 μV p-p (0.1 Hz to 10 Hz), it is perfectly suited for applications where large error sources cannot be tolerated. Many systems can take advantage of the low noise, dc precision, and rail-to-rail output swing provided by the AD8622 to maximize the signal-to-noise ratio and dynamic range for low power operation. The AD8622 is specified for the extended industrial temperature range of -40°C to $+125^\circ\text{C}$ and is available in lead-free SOIC and MSOP packages.

PIN CONFIGURATIONS

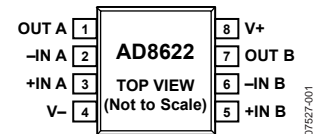

Figure 1. 8-Lead Narrow-Body SOIC

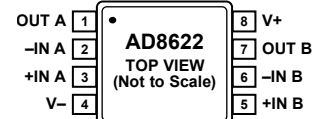

Figure 2. 8-Lead MSOP

Table 1. Low Power Op Amps

Supply	40 V	36 V	12 V to 16 V	5 V
Single	OP97	OP777 OP1177	OP196 AD8663	AD8603
Dual	OP297	OP727 OP2177 AD706	OP296 AD8667	AD8607
Quad	OP497	OP747 OP4177 AD704	OP496 AD8669	AD8609

Rev. 0

Information furnished by Analog Devices is believed to be accurate and reliable. However, no responsibility is assumed by Analog Devices for its use, nor for any infringements of patents or other rights of third parties that may result from its use. Specifications subject to change without notice. No license is granted by implication or otherwise under any patent or patent rights of Analog Devices. Trademarks and registered trademarks are the property of their respective owners.

TABLE OF CONTENTS

Features	1	ESD Caution.....	5
Applications.....	1	Typical Performance Characteristics	6
Pin Configurations	1	Applications Information	15
General Description	1	Input Protection	15
Revision History	2	Phase Reversal	15
Specifications.....	3	Micropower Instrumentation Amplifier	15
Electrical Characteristics— ± 15 V Operation.....	3	Hall Sensor Signal Conditioning.....	16
Electrical Characteristics— ± 2.5 V Operation.....	4	Simplified Schematic.....	17
Absolute Maximum Ratings.....	5	Outline Dimensions	18
Thermal Resistance	5	Ordering Guide	18

REVISION HISTORY

7/09—Revision 0: Initial Version

SPECIFICATIONS

ELECTRICAL CHARACTERISTICS— ± 15 V OPERATION

$V_S = \pm 15$ V, $V_{CM} = 0$ V, $T_A = +25^\circ\text{C}$, unless otherwise specified.

Table 2.

Parameter	Symbol	Conditions	Min	Typ	Max	Unit
INPUT CHARACTERISTICS						
Offset Voltage	V_{OS}	$-40^\circ\text{C} \leq T_A \leq +125^\circ\text{C}$		10	125	μV
					230	μV
Offset Voltage Drift	$\Delta V_{OS}/\Delta T$	$-40^\circ\text{C} \leq T_A \leq +125^\circ\text{C}$		0.5	1.2	$\mu\text{V}/^\circ\text{C}$
Input Bias Current	I_B	$-40^\circ\text{C} \leq T_A \leq +125^\circ\text{C}$		45	200	pA
					500	pA
Input Offset Current	I_{OS}	$-40^\circ\text{C} \leq T_A \leq +125^\circ\text{C}$		35	200	pA
					500	pA
Input Voltage Range			-13.8		+13.8	V
Common-Mode Rejection Ratio	CMRR	$V_{CM} = -13.8$ V to $+13.8$ V $-40^\circ\text{C} \leq T_A \leq +125^\circ\text{C}$	125	135		dB
			112			dB
Open-Loop Gain	A_{VO}	$R_L = 10$ k Ω , $V_O = -13.5$ V to $+13.5$ V $-40^\circ\text{C} \leq T_A \leq +125^\circ\text{C}$	125	137		dB
			120			dB
Input Resistance, Differential Mode	R_{INDM}			1		G Ω
Input Resistance, Common Mode	R_{INCM}			1		T Ω
Input Capacitance, Differential Mode	C_{INDM}			5.5		pF
Input Capacitance, Common Mode	C_{INCM}			3		pF
OUTPUT CHARACTERISTICS						
Output Voltage High	V_{OH}	$R_L = 100$ k Ω to ground $-40^\circ\text{C} \leq T_A \leq +125^\circ\text{C}$	14.94	14.97		V
			14.84			V
		$R_L = 10$ k Ω to ground $-40^\circ\text{C} \leq T_A \leq +125^\circ\text{C}$	14.86	14.89		V
			14.75			V
Output Voltage Low	V_{OL}	$R_L = 100$ k Ω to ground $-40^\circ\text{C} \leq T_A \leq +125^\circ\text{C}$		-14.97	-14.94	V
					-14.92	V
		$R_L = 10$ k Ω to ground $-40^\circ\text{C} \leq T_A \leq +125^\circ\text{C}$		-14.89	-14.90	V
					-14.80	V
Short-Circuit Current	I_{SC}			± 40		mA
Closed-Loop Output Impedance	Z_{OUT}	$f = 1$ kHz, $A_V = 1$		1.5		Ω
POWER SUPPLY						
Power Supply Rejection Ratio	PSRR	$V_S = \pm 2.0$ V to ± 18.0 V $-40^\circ\text{C} \leq T_A \leq +125^\circ\text{C}$	125	145		dB
			120			dB
Supply Current/Amplifier	I_{SY}	$I_O = 0$ mA $-40^\circ\text{C} \leq T_A \leq +125^\circ\text{C}$		215	250	μA
					350	μA
DYNAMIC PERFORMANCE						
Slew Rate	SR	$R_L = 10$ k Ω , $A_V = 1$		0.48		V/ μs
Gain Bandwidth Product	GBP	$C_L = 35$ pF, $A_V = 1$		600		kHz
Phase Margin	Φ_M	$C_L = 35$ pF, $A_V = 1$		72		Degrees
NOISE PERFORMANCE						
Voltage Noise	e_n p-p	$f = 0.1$ Hz to 10 Hz		0.2		μV p-p
Voltage Noise Density	e_n	$f = 1$ kHz		11		nV/ $\sqrt{\text{Hz}}$
Uncorrelated Current Noise Density	i_n	$f = 1$ kHz		0.15		pA/ $\sqrt{\text{Hz}}$
Correlated Current Noise Density	i_n	$f = 1$ kHz		0.06		pA/ $\sqrt{\text{Hz}}$

AD8622

ELECTRICAL CHARACTERISTICS—±2.5 V OPERATION

$V_S = \pm 2.5$ V, $V_{CM} = 0$ V, $T_A = +25^\circ\text{C}$, unless otherwise specified.

Table 3.

Parameter	Symbol	Conditions	Min	Typ	Max	Unit
INPUT CHARACTERISTICS						
Offset Voltage	V_{OS}	$-40^\circ\text{C} \leq T_A \leq +125^\circ\text{C}$		10	125	μV
					230	μV
Offset Voltage Drift	$\Delta V_{OS}/\Delta T$	$-40^\circ\text{C} \leq T_A \leq +125^\circ\text{C}$		0.5	1.2	$\mu\text{V}/^\circ\text{C}$
Input Bias Current	I_B	$-40^\circ\text{C} \leq T_A \leq +125^\circ\text{C}$		30	200	pA
					400	pA
Input Offset Current	I_{OS}	$-40^\circ\text{C} \leq T_A \leq +125^\circ\text{C}$		25	200	pA
					300	pA
Input Voltage Range		$-40^\circ\text{C} \leq T_A \leq +125^\circ\text{C}$	-1.3		+1.3	V
Common-Mode Rejection Ratio	CMRR	$V_{CM} = -1.3$ V to +1.3 V $-40^\circ\text{C} \leq T_A \leq +125^\circ\text{C}$	110	120		dB
			107			dB
Open-Loop Gain	A_{VO}	$R_L = 10$ k Ω , $V_O = -2.0$ V to +2.0 V $-40^\circ\text{C} \leq T_A \leq +125^\circ\text{C}$	118	135		dB
			109			dB
Input Resistance, Differential Mode	R_{INDM}			1		G Ω
Input Resistance, Common Mode	R_{INCM}			1		T Ω
Input Capacitance, Differential Mode	C_{INDM}			5.5		pF
Input Capacitance, Common Mode	C_{INCM}			3		pF
OUTPUT CHARACTERISTICS						
Output Voltage High	V_{OH}	$R_L = 100$ k Ω to ground $-40^\circ\text{C} \leq T_A \leq +125^\circ\text{C}$	2.45	2.49		V
			2.41			V
		$R_L = 10$ k Ω to ground $-40^\circ\text{C} \leq T_A \leq +125^\circ\text{C}$	2.40	2.45		V
			2.36			V
Output Voltage Low	V_{OL}	$R_L = 100$ k Ω to ground $-40^\circ\text{C} \leq T_A \leq +125^\circ\text{C}$		-2.49	-2.45	V
					-2.41	V
		$R_L = 10$ k Ω to ground $-40^\circ\text{C} \leq T_A \leq +125^\circ\text{C}$		-2.45	-2.40	V
					-2.36	V
Short-Circuit Current	I_{SC}			± 30		mA
Closed-Loop Output Impedance	Z_{OUT}	$f = 1$ kHz, $A_v = 1$		2		Ω
POWER SUPPLY						
Power Supply Rejection Ratio	PSRR	$V_S = \pm 2.0$ V to ± 18.0 V $-40^\circ\text{C} \leq T_A \leq +125^\circ\text{C}$	125	145		dB
			120			dB
Supply Current/Amplifier	I_{SY}	$I_O = 0$ mA $-40^\circ\text{C} \leq T_A \leq +125^\circ\text{C}$		175	225	μA
					310	μA
DYNAMIC PERFORMANCE						
Slew Rate	SR	$R_L = 10$ k Ω , $A_v = 1$		0.28		V/ μs
Gain Bandwidth Product	GBP	$C_L = 35$ pF, $A_v = 1$		580		kHz
Phase Margin	Φ_M	$C_L = 35$ pF, $A_v = 1$		72		Degrees
NOISE PERFORMANCE						
Voltage Noise	e_n p-p	$f = 0.1$ Hz to 10 Hz		0.2		μV p-p
Voltage Noise Density	e_n	$f = 1$ kHz		12		nV/ $\sqrt{\text{Hz}}$
Uncorrelated Current Noise Density	i_n	$f = 1$ kHz		0.15		pA/ $\sqrt{\text{Hz}}$
Correlated Current Noise Density	i_n	$f = 1$ kHz		0.07		pA/ $\sqrt{\text{Hz}}$

ABSOLUTE MAXIMUM RATINGS

Table 4.

Parameter	Rating
Supply Voltage	± 18 V
Input Voltage	$\pm V$ supply
Input Current ¹	± 10 mA
Differential Input Voltage ²	± 10 V
Output Short-Circuit Duration to GND	Indefinite
Storage Temperature Range	-65°C to $+150^{\circ}\text{C}$
Operating Temperature Range	-40°C to $+125^{\circ}\text{C}$
Junction Temperature Range	-65°C to $+150^{\circ}\text{C}$
Lead Temperature (Soldering, 60 sec)	300°C

¹The input pins have clamp diodes to the power supply pins. The input current should be limited to 10 mA or less whenever input signals exceed the power supply rail by 0.5 V.

²Differential input voltage is limited to 10 V or the supply voltage, whichever is less.

Stresses above those listed under Absolute Maximum Ratings may cause permanent damage to the device. This is a stress rating only; functional operation of the device at these or any other conditions above those indicated in the operational section of this specification is not implied. Exposure to absolute maximum rating conditions for extended periods may affect device reliability.

THERMAL RESISTANCE

θ_{JA} is specified for the worst-case conditions, that is, a device soldered in a circuit board for surface-mount packages. This was measured using a standard 4-layer board.

Table 5. Thermal Resistance

Package Type	θ_{JA}	θ_{JC}	Unit
8-Lead SOIC_N (R-8)	158	43	$^{\circ}\text{C}/\text{W}$
8-Lead MSOP (RM-8)	185	53	$^{\circ}\text{C}/\text{W}$

ESD CAUTION



ESD (electrostatic discharge) sensitive device. Charged devices and circuit boards can discharge without detection. Although this product features patented or proprietary protection circuitry, damage may occur on devices subjected to high energy ESD. Therefore, proper ESD precautions should be taken to avoid performance degradation or loss of functionality.

TYPICAL PERFORMANCE CHARACTERISTICS

T_A = 25°C, unless otherwise noted.

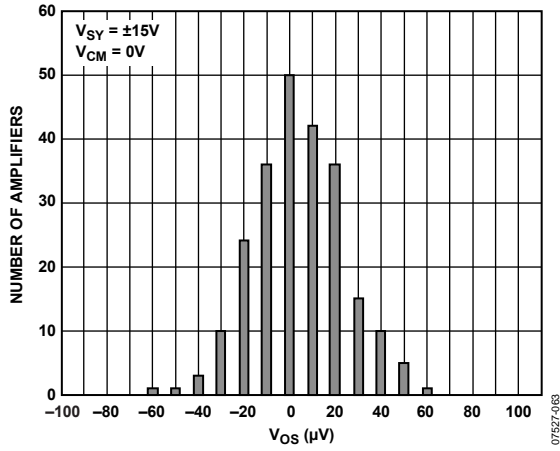

Figure 3. Input Offset Voltage Distribution

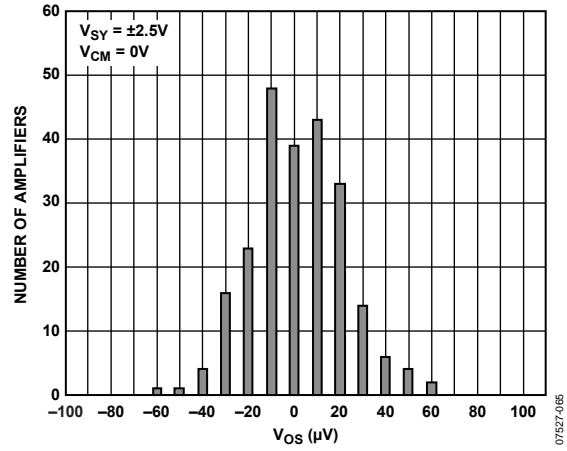

Figure 6. Input Offset Voltage Distribution

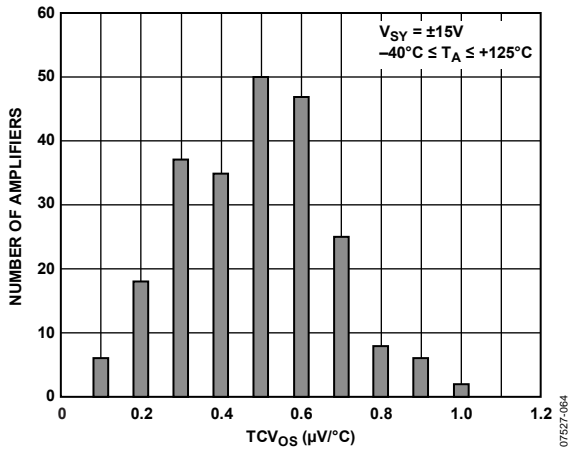

Figure 4. Input Offset Voltage Drift Distribution

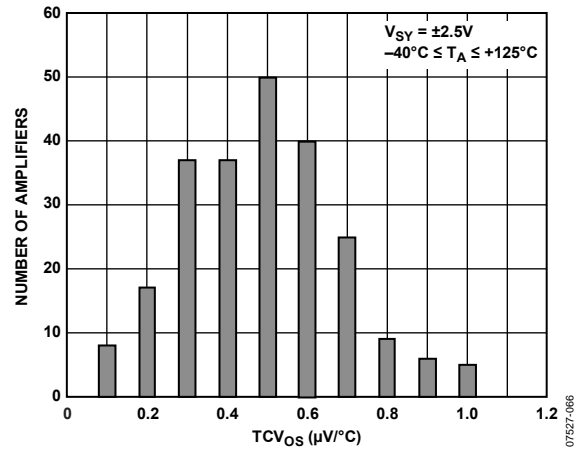

Figure 7. Input Offset Voltage Drift Distribution

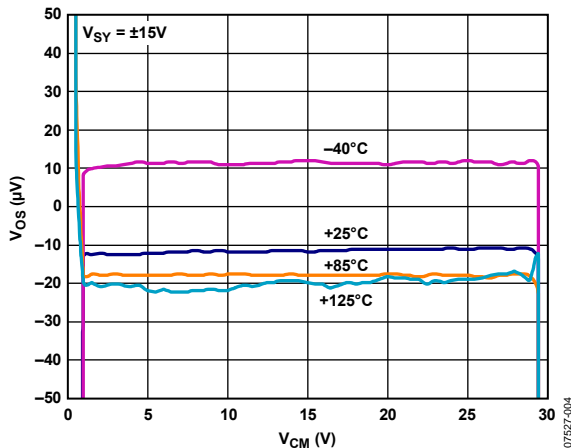

Figure 5. Input Offset Voltage vs. Common-Mode Voltage

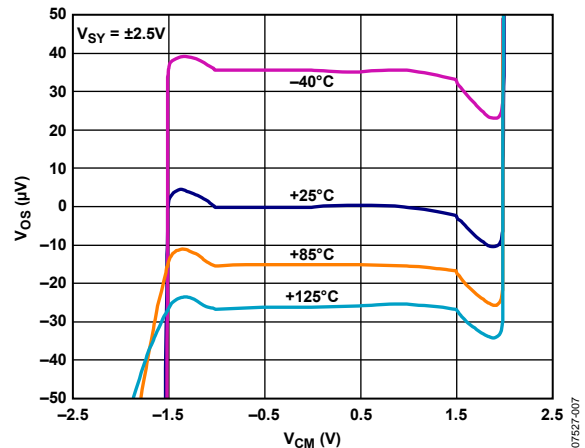

Figure 8. Input Offset Voltage vs. Common-Mode Voltage

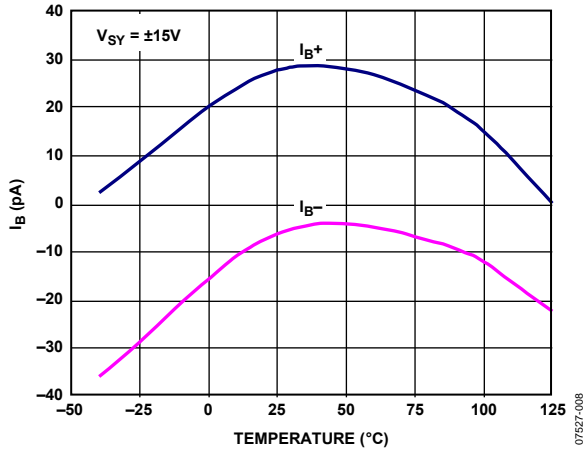

Figure 9. Input Bias Current vs. Temperature

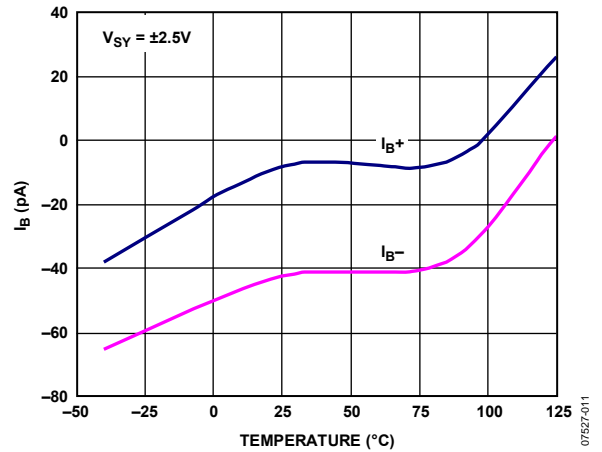

Figure 12. Input Bias Current vs. Temperature

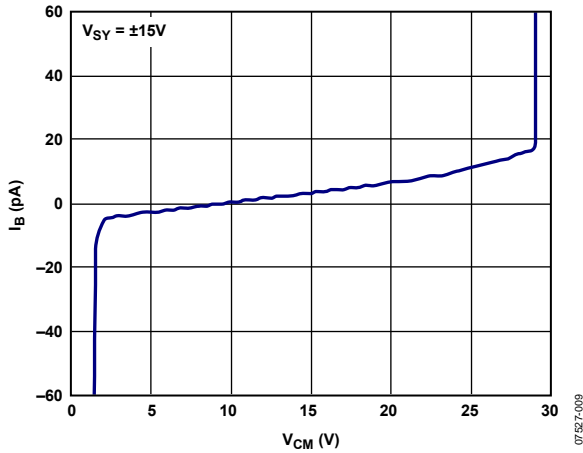

Figure 10. Input Bias Current vs. Common-Mode Voltage

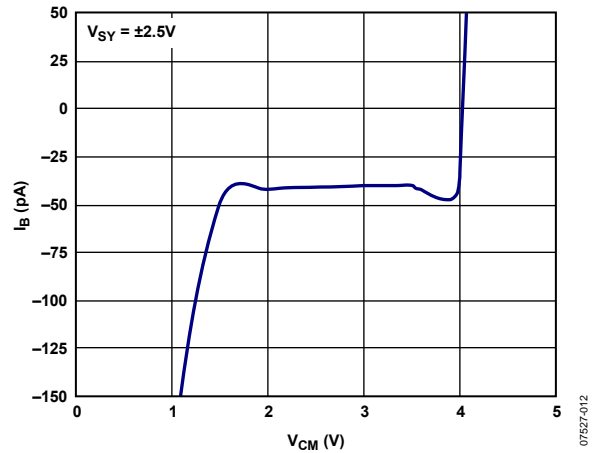

Figure 13. Input Bias Current vs. Common-Mode Voltage

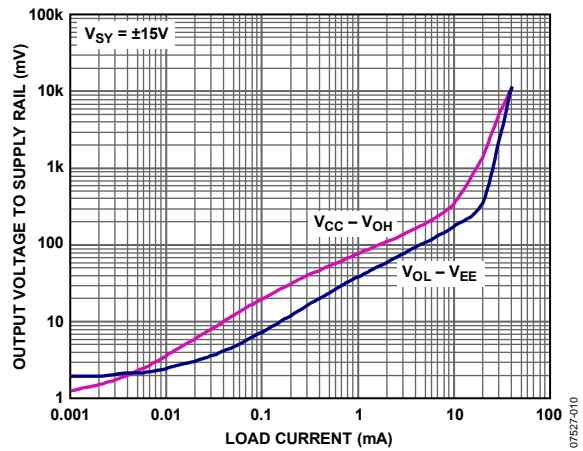

Figure 11. Output Voltage to Supply Rail vs. Load Current

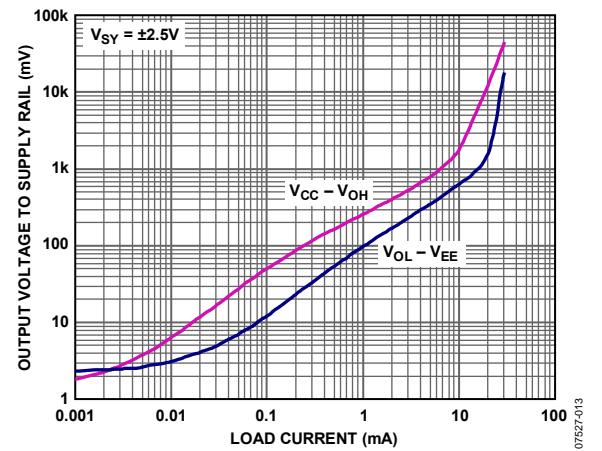

Figure 14. Output Voltage to Supply Rail vs. Load Current

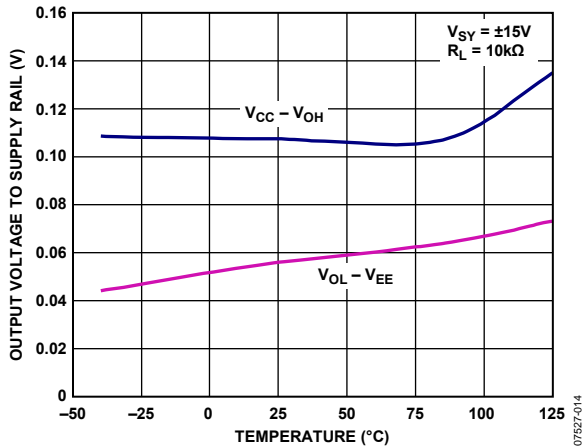

Figure 15. Output Voltage to Supply Rail vs. Temperature

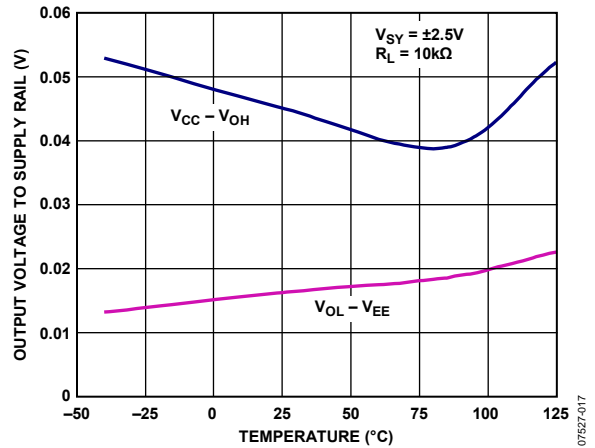

Figure 18. Output Voltage to Supply Rail vs. Temperature

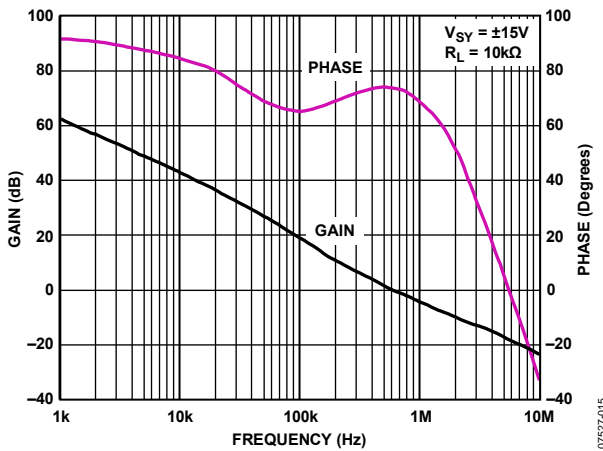

Figure 16. Open-Loop Gain and Phase vs. Frequency

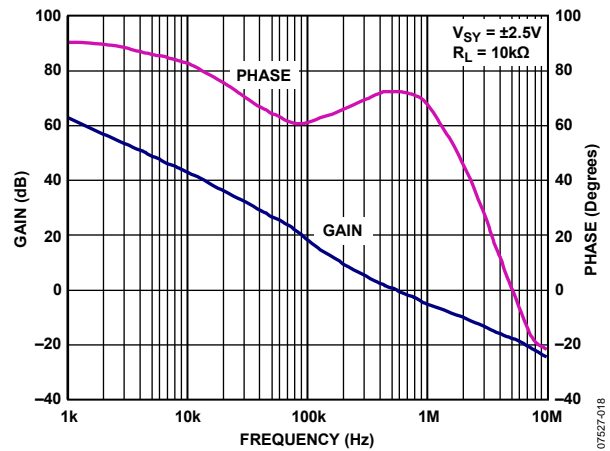

Figure 19. Open-Loop Gain and Phase vs. Frequency

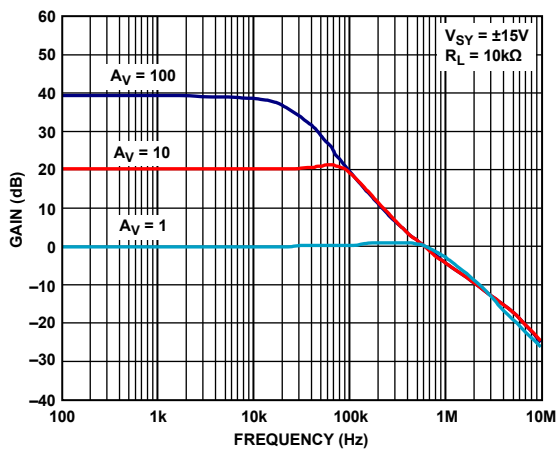

Figure 17. Closed-Loop Gain vs. Frequency

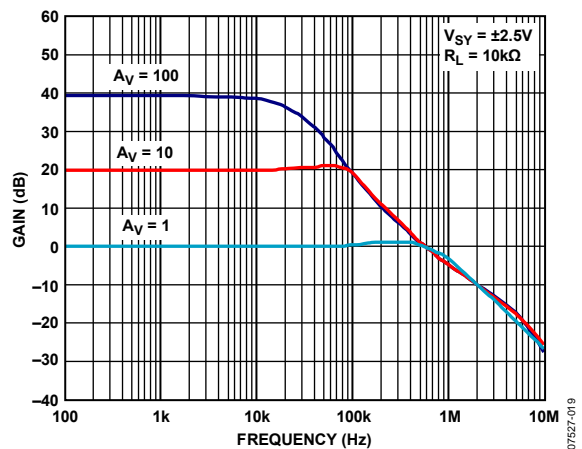

Figure 20. Closed-Loop Gain vs. Frequency

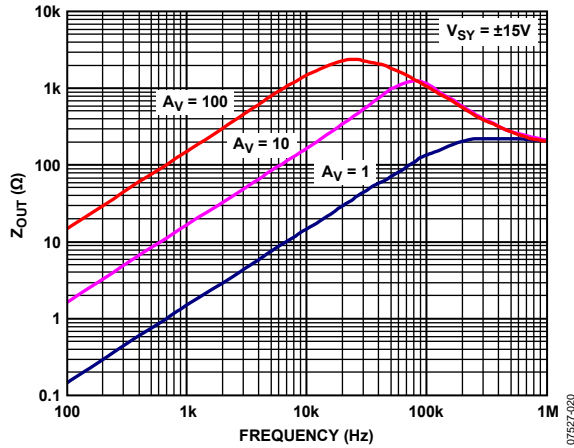

Figure 21. Output Impedance vs. Frequency

07527-020

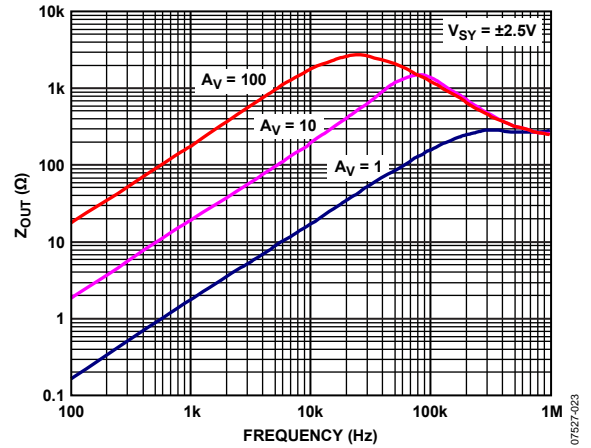

Figure 24. Output Impedance vs. Frequency

07527-023

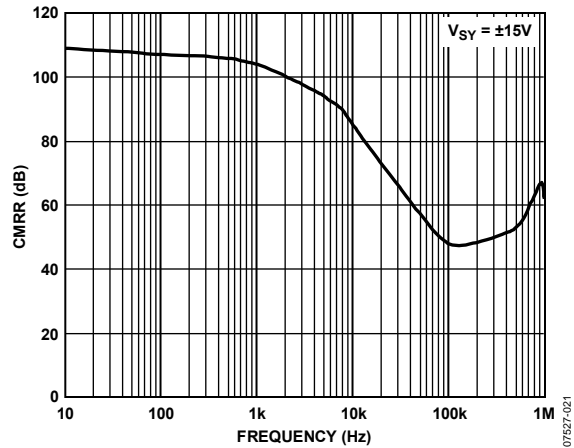

Figure 22. CMRR vs. Frequency

07527-021

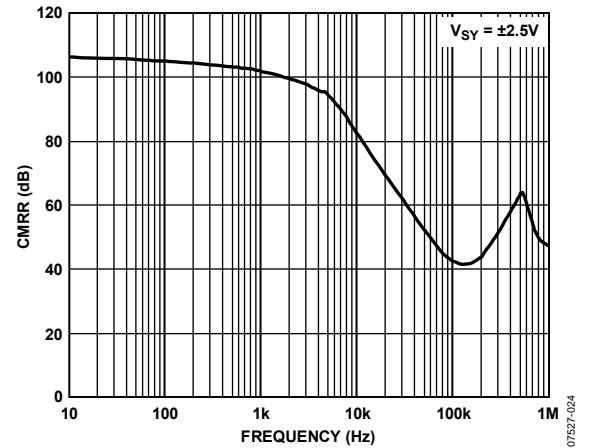

Figure 25. CMRR vs. Frequency

07527-024

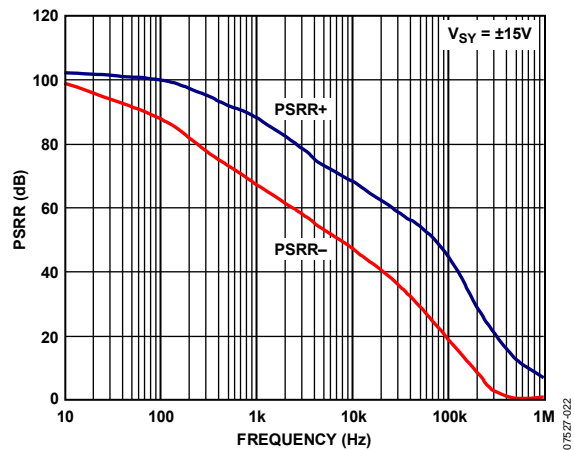

Figure 23. PSRR vs. Frequency

07527-022

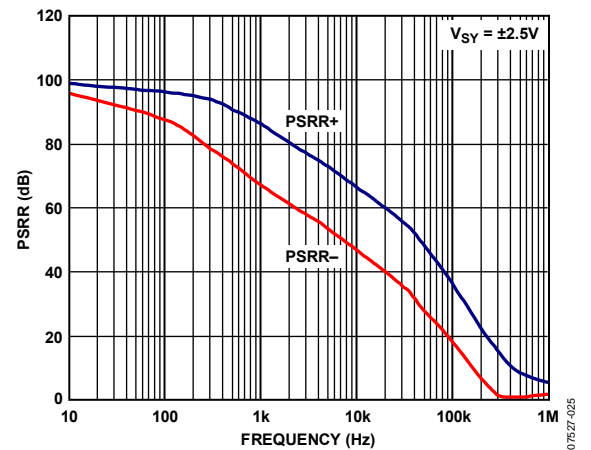

Figure 26. PSRR vs. Frequency

07527-025

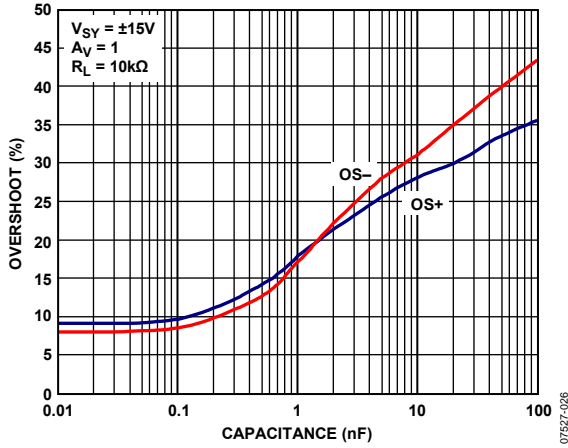

Figure 27. Small-Signal Overshoot vs. Load Capacitance

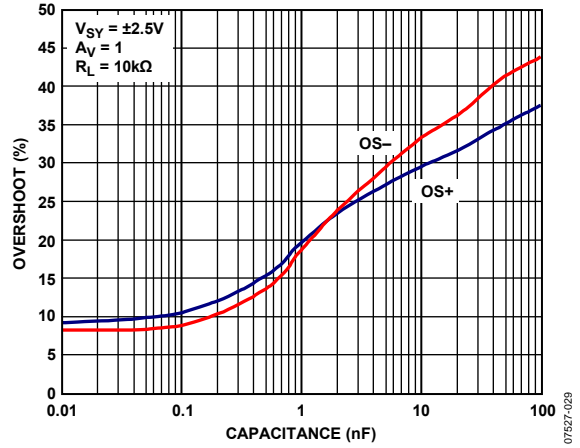

Figure 30. Small-Signal Overshoot vs. Load Capacitance

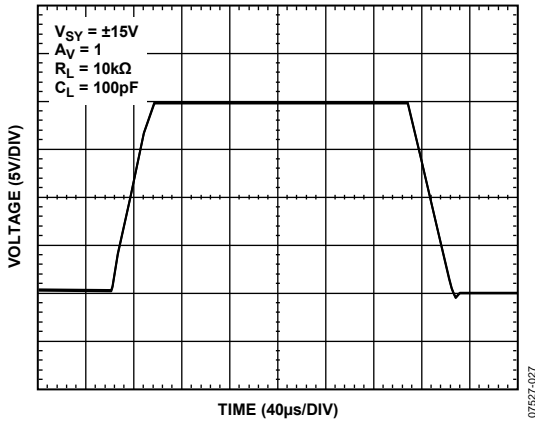

Figure 28. Large-Signal Transient Response

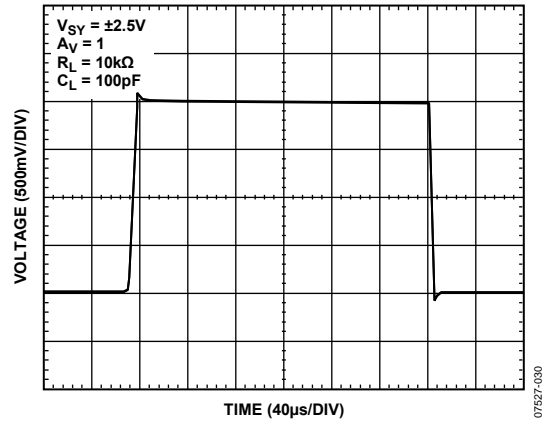

Figure 31. Large-Signal Transient Response

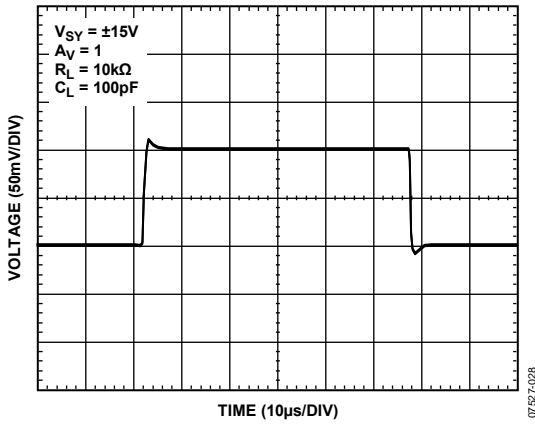

Figure 29. Small-Signal Transient Response

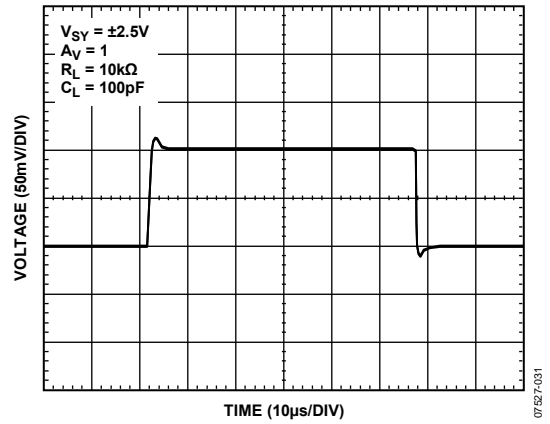

Figure 32. Small-Signal Transient Response

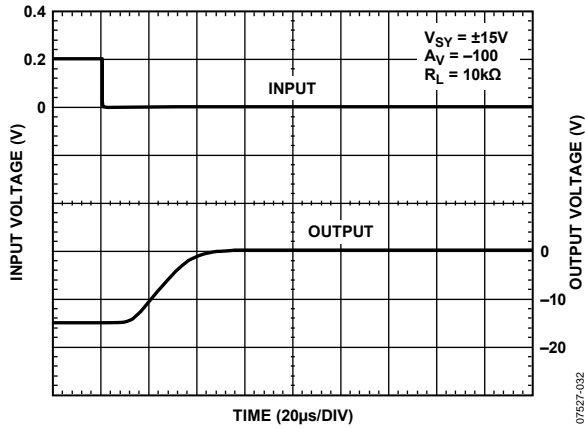

Figure 33. Negative Overload Recovery

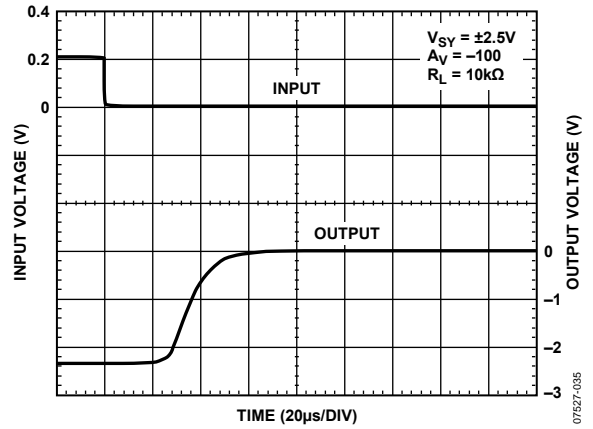

Figure 36. Negative Overload Recovery

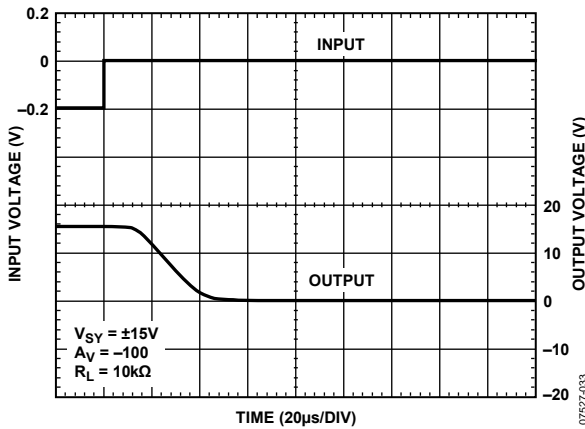

Figure 34. Positive Overload Recovery

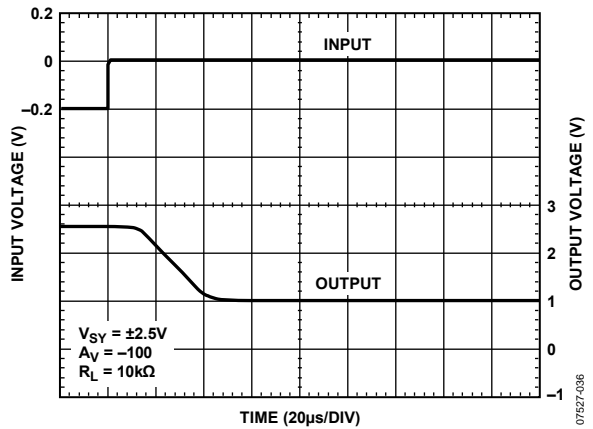

Figure 37. Positive Overload Recovery

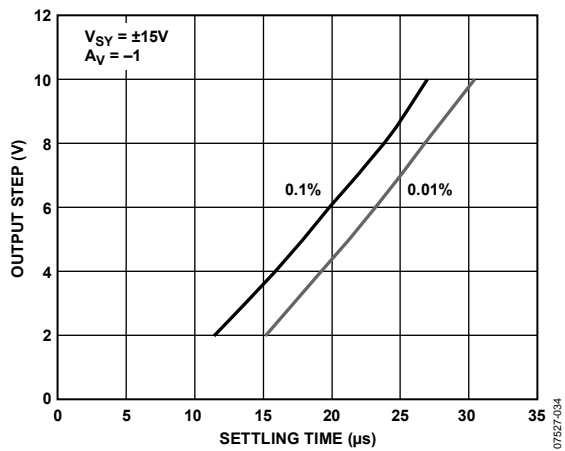

Figure 35. Output Step vs. Settling Time

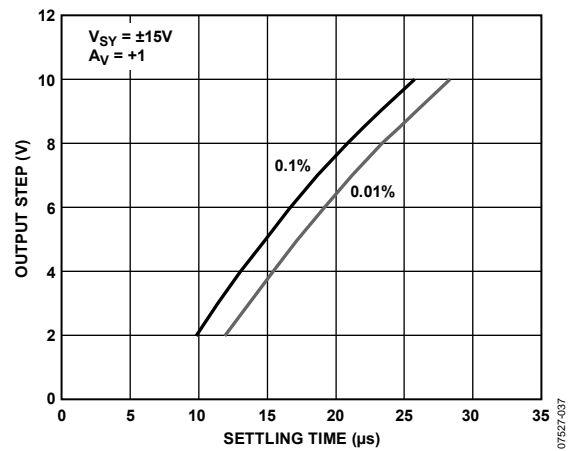

Figure 38. Output Step vs. Settling Time

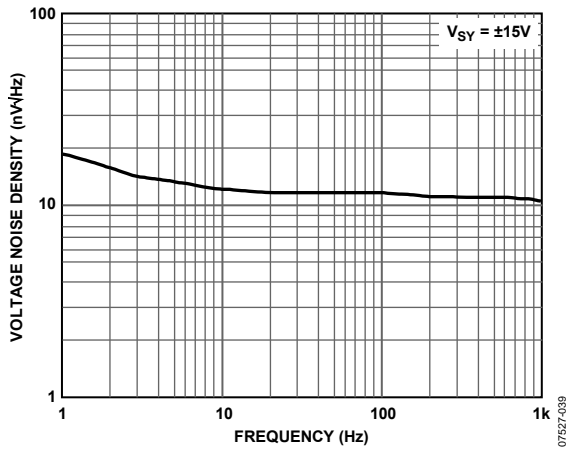

Figure 39. Voltage Noise Density vs. Frequency

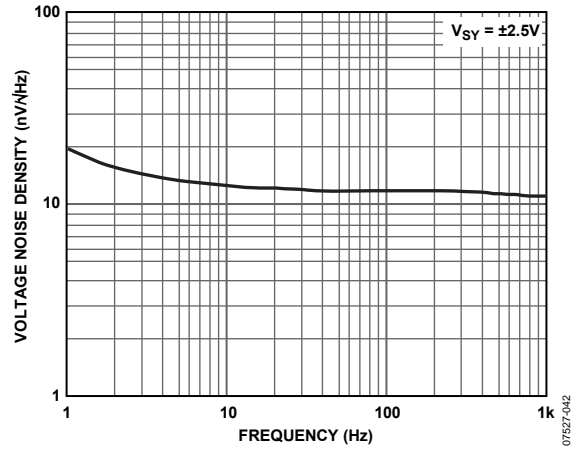

Figure 42. Voltage Noise Density vs. Frequency

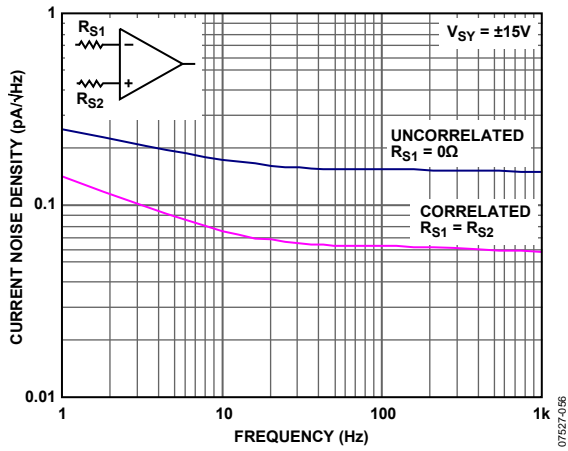

Figure 40. Current Noise Density vs. Frequency

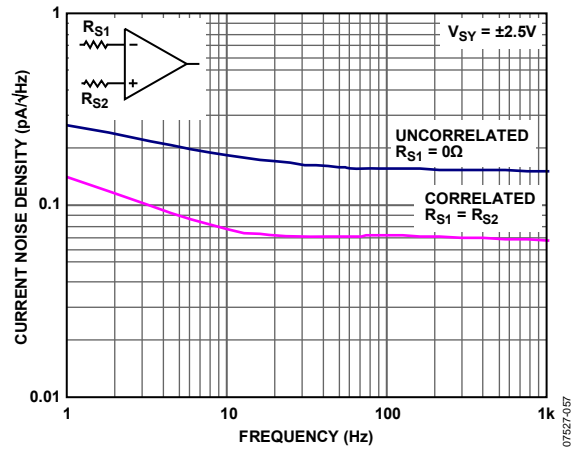

Figure 43. Current Noise Density vs. Frequency

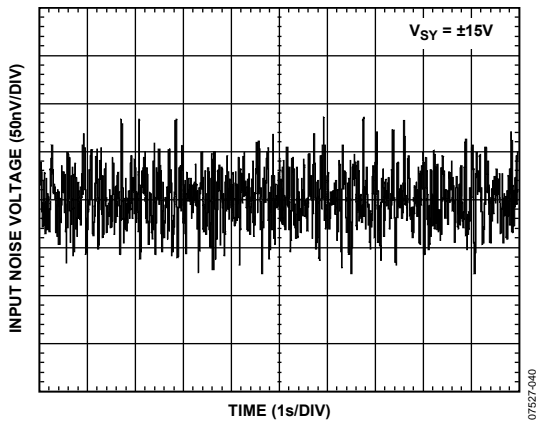

Figure 41. 0.1 Hz to 10 Hz Noise

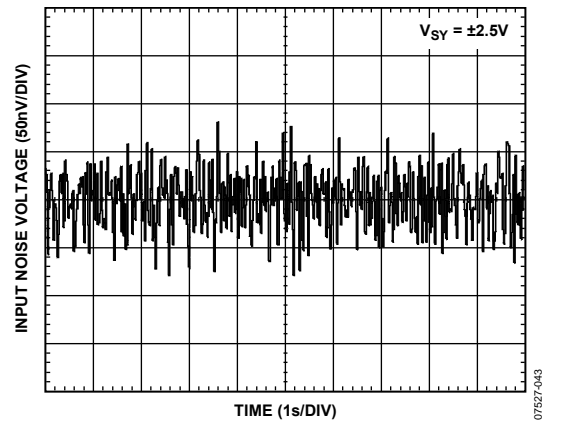

Figure 44. 0.1 Hz to 10 Hz Noise

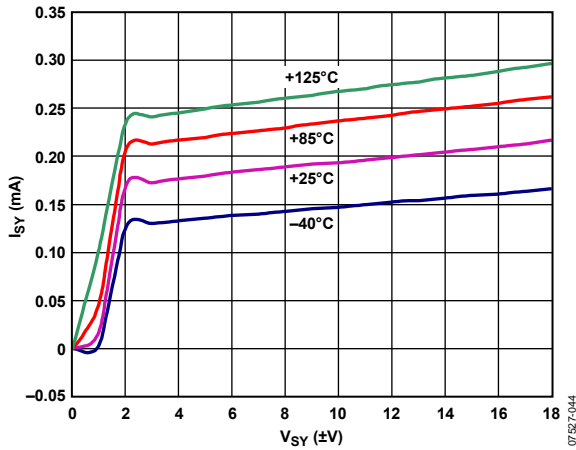

Figure 45. Supply Current vs. Supply Voltage

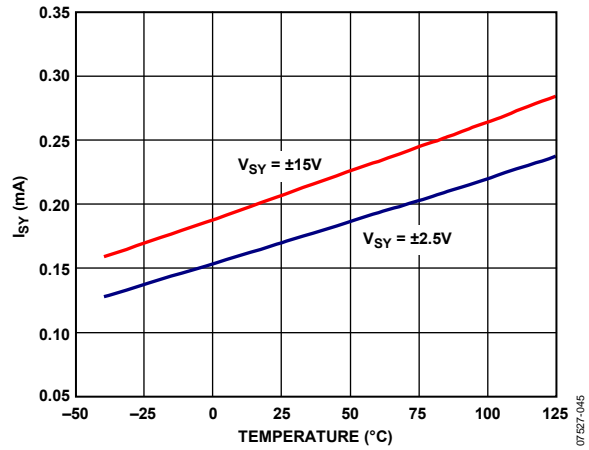

Figure 48. Supply Current vs. Temperature

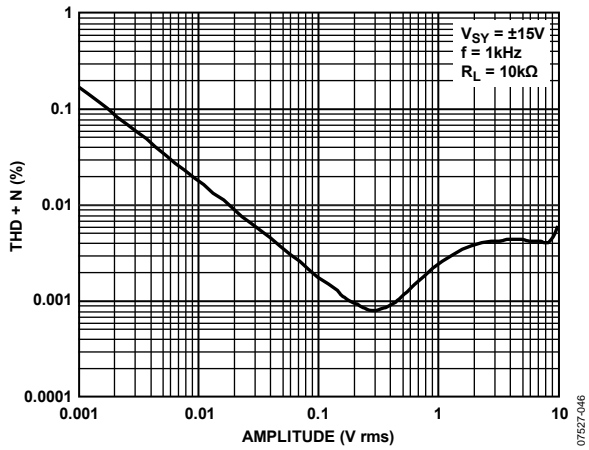

Figure 46. THD + Noise vs. Amplitude

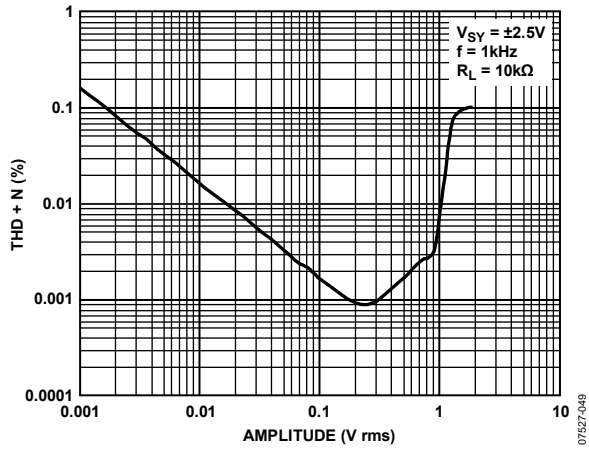

Figure 49. THD + Noise vs. Amplitude

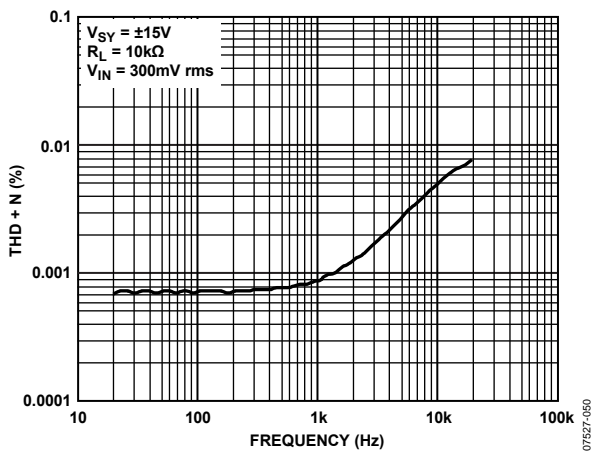

Figure 47. THD + Noise vs. Frequency

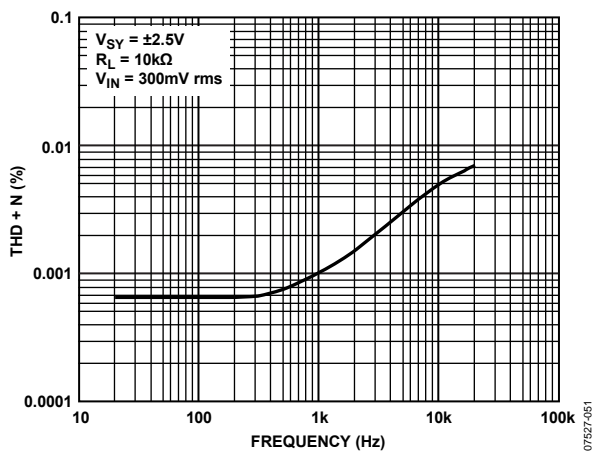

Figure 50. THD + Noise vs. Frequency

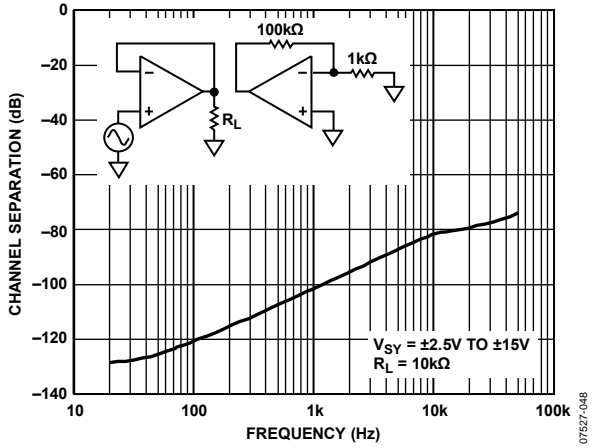

Figure 51. Channel Separation vs. Frequency

APPLICATIONS INFORMATION

INPUT PROTECTION

The maximum differential input voltage that can be applied to the AD8622 is determined by the internal diodes connected across its inputs and series resistors at each input. These internal diodes and series resistors limit the maximum differential input voltage to ± 10 V and are needed to prevent base-emitter junction breakdown from occurring in the input stage of the AD8622 when very large differential voltages are applied. In addition, the internal resistors limit the currents that flow through the diodes. However, in applications where large differential voltages can be inadvertently applied to the device, large currents may still flow through these diodes. In such a case, external resistors must be placed at both inputs of the op amp to limit the input currents to ± 10 mA (see Figure 52).

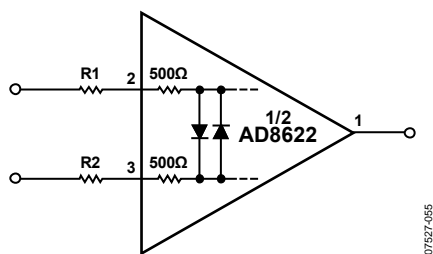

Figure 52. Input Protection

PHASE REVERSAL

An undesired phenomenon, phase reversal (also known as phase inversion) occurs in many op amps when one or both of the inputs are driven beyond the specified input voltage range (IVR), in effect reversing the polarity of the output. In some cases, phase reversal can induce lockups and even cause equipment damage as well as self destruction.

The AD8622 amplifiers have been carefully designed to prevent output phase reversal when both inputs are maintained within the specified input voltage range. In addition, even if one or both inputs exceed the input voltage range but remain within the supply rails, the output still does not phase reverse. Figure 53 shows the input/output waveforms of the AD8622 configured as a unity-gain buffer with a supply voltage of ± 15 V.

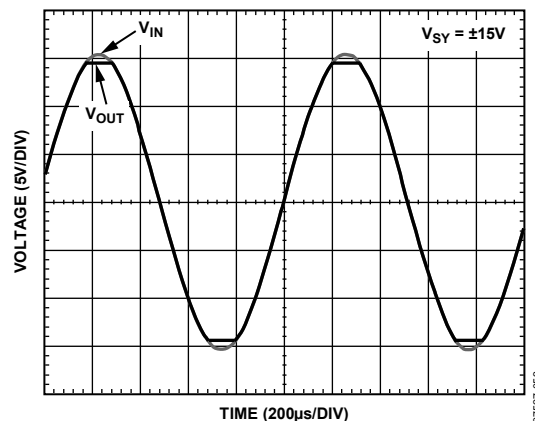
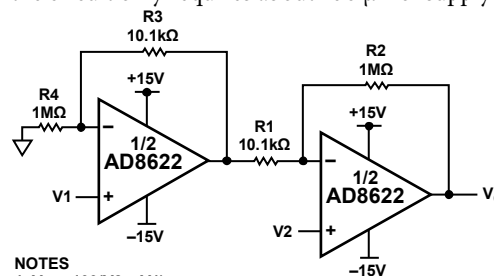

Figure 53. No Phase Reversal

MICROPOWER INSTRUMENTATION AMPLIFIER

The AD8622 is a dual, high precision, rail-to-rail output op amp operating at just 215 μ A quiescent current per amplifier. Its ultralow offset, offset drift, and voltage noise, combined with its very low bias current and high common-mode rejection ratio (CMRR), are ideally suited for high accuracy and micropower instrumentation amplifier.

Figure 54 shows the classic 2-op-amp instrumentation amplifier with four resistors using the AD8622. The key to high CMRR for this instrumentation amplifier are resistors that are well matched from both the resistive ratio and the relative drift. For true difference amplification, matching of the resistor ratio is very important, where $R3/R4 = R1/R2$. Assuming perfectly matched resistors, the gain of the circuit is $1 + R2/R1$, which is approximately 100. Tighter matching of two op amps in one package, like the AD8622, offers a significant boost in performance over the classical 3-op-amp configuration. Overall, the circuit only requires about 430 μ A of supply current.



NOTES

- $V_O = 100(V_2 - V_1)$
- TYPICAL: $0.01\text{mV} < |V_2 - V_1| < 149.7\text{mV}$
- TYPICAL: $-14.97\text{V} < V_O < +14.97\text{V}$
- USE MATCHED RESISTORS.

Figure 54. Micropower Instrumentation Amplifier

AD8622

HALL SENSOR SIGNAL CONDITIONING

The AD8622 is also highly suitable for high accuracy, low power signal conditioning circuits. One such use is in Hall sensor signal conditioning (see Figure 55). The magnetic sensitivity of a Hall element is proportional to the bias voltage applied across it. With 1 V bias voltage, the Hall element consumes about 2.5 mA of supply current and has a sensitivity of 5.5 mV/mT typical. To reduce power consumption, bias voltage must be reduced, but at the risk of lower sensitivity. The only way to achieve higher sensitivity is by introducing a gain using a precision micropower amplifier. The AD8622, with all its features, is well suited to amplify the sensitivity of the Hall element.

The ADR121 is a precision micropower 2.5 V voltage reference. A precision voltage reference is required to hold a constant current so that the Hall voltage only depends on the intensity of the magnetic field. Using the 4.12k:98.8k resistive divider, the bias voltage of the Hall element is reduced to 100 mV, leading to only 250 μ A of power consumption. The 3-op-amp in-amp configuration of the AD8622 then increases the sensitivity to 55 mV/mT. Using the AD8622 to amplify the sensor signal can reduce power while also achieving higher sensitivity. The total current consumed is just 1.2 mA, resulting in 21 \times improvement in sensitivity/power.

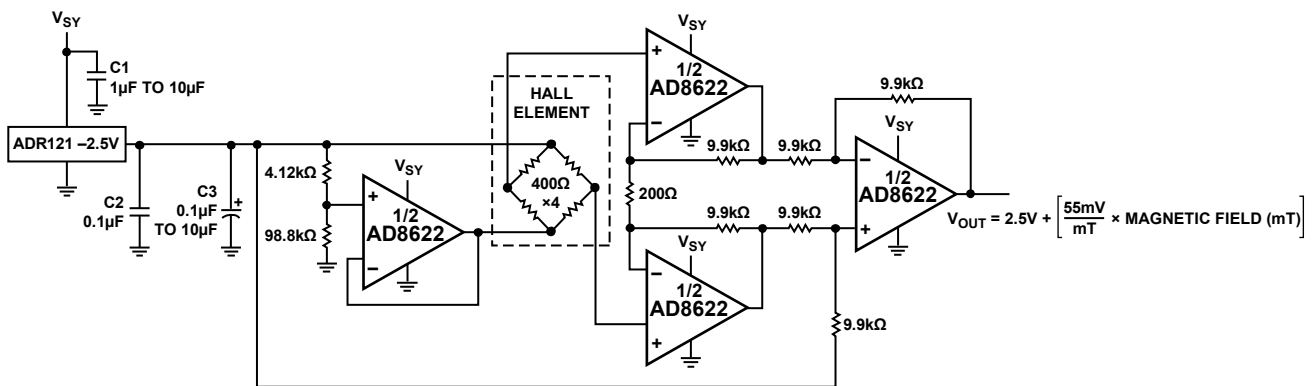

NOTES

1. USE MATCHED RESISTORS FOR IN-AMP.
2. FOR INFORMATION ON C1, C2, AND C3, REFER TO ADR121 DATA SHEET.

Figure 55. Hall Sensor Signal Conditioning

07527-052

SIMPLIFIED SCHEMATIC

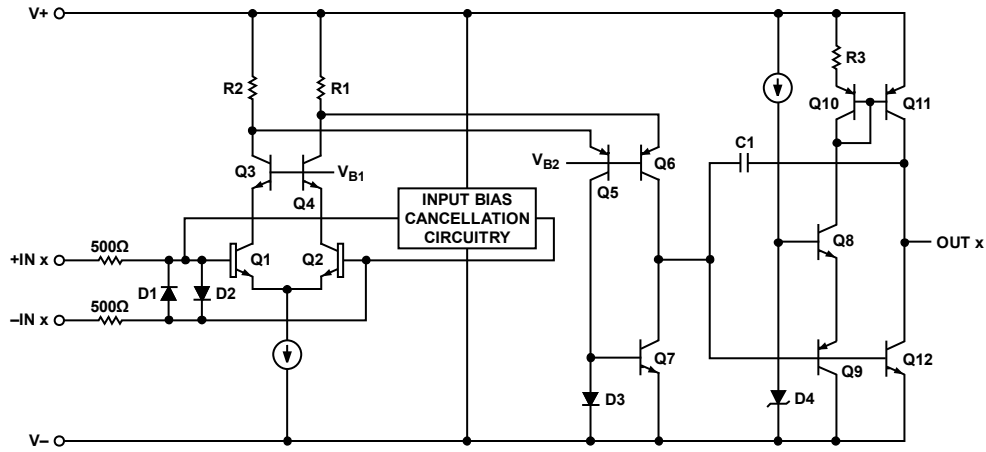
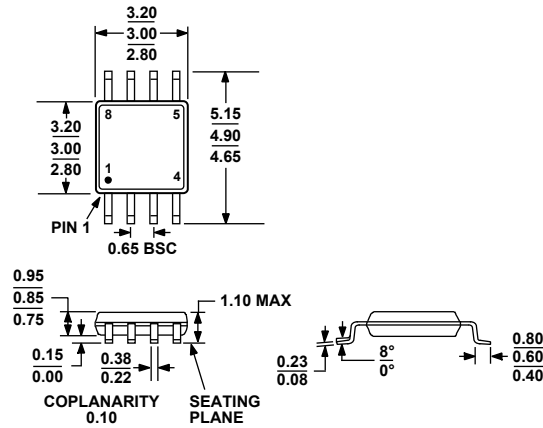

Figure 56. Simplified Schematic

079527-062

OUTLINE DIMENSIONS



COMPLIANT TO JEDEC STANDARDS MO-187-AA

Figure 57. 8-Lead Mini Small Outline Package [MSOP] (RM-8)

Dimensions shown in millimeters

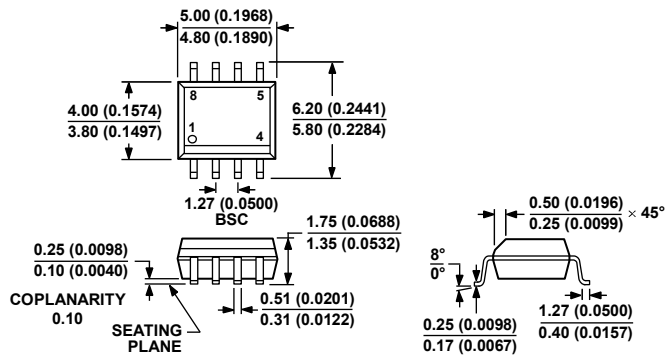

COMPLIANT TO JEDEC STANDARDS MS-012-AA

CONTROLLING DIMENSIONS ARE IN MILLIMETERS; INCH DIMENSIONS (IN PARENTHESES) ARE ROUNDED-OFF MILLIMETER EQUIVALENTS FOR REFERENCE ONLY AND ARE NOT APPROPRIATE FOR USE IN DESIGN.

Figure 58. 8-Lead Standard Small Outline Package [SOIC_N] Narrow Body (R-8)

Dimensions shown in millimeters and (inches)

ORDERING GUIDE

Model	Temperature Range	Package Description	Package Option	Branding
AD8622ARMZ ¹	-40°C to +125°C	8-Lead MSOP	RM-8	A1P
AD8622ARMZ-REEL ¹	-40°C to +125°C	8-Lead MSOP	RM-8	A1P
AD8622ARMZ-R7 ¹	-40°C to +125°C	8-Lead MSOP	RM-8	A1P
AD8622ARZ ¹	-40°C to +125°C	8-Lead SOIC_N	R-8	
AD8622ARZ-REEL ¹	-40°C to +125°C	8-Lead SOIC_N	R-8	
AD8622ARZ-REEL7 ¹	-40°C to +125°C	8-Lead SOIC_N	R-8	

¹ Z = RoHS Compliant Part.

NOTES

AD8622

NOTES