

## UNIVERSAL ISM BAND FSK TRANSCEIVER MODULE

### RFM12

(the purpose of this spec covers mainly for the physical characteristic of the module, for register configure and its related command info please refer to [RF12 data sheets](#))

### General Introduction

RFM12 is a low costing ISM band transceiver module implemented with unique PLL. It works signal ranges from 315/433/868/915MHZ bands, comply with FCC, ETSI regulation. The SPI interface is used to communicate with microcontroller for parameter setting.

### Features:

- Low costing, high performance and price ratio
- Tuning free during production
- PLL and zero IF technology
- Fast PLL lock time
- High resolution PLL with 2.5 KHz step
- High data rate (up to 115.2 kbps with internal demodulator, with external RC filter highest data rate is 256 kbps)
- Differential antenna input
- Automatic antenna tuning
- Programmable TX frequency deviation (from 15 to 240 KHz)
- Programmable receiver bandwidth (from 67 to 400 kHz)
- Analog and digital signal strength indicator (ARSSI/DRSSI)
- AFC
- DQD
- Internal data filtering and clock recovery
- RX synchron pattern recognition
- SPI interface
- Clock and reset signal output for external MCU use
- 16 bit RX Data FIFO
- Two 8 bit TX data registers
- 10MHz crystal for PLL timing
- Wakeup timer
- 2.2V - 5.4V power supply
- Low power consumption
- Standby current less than 0.3uA

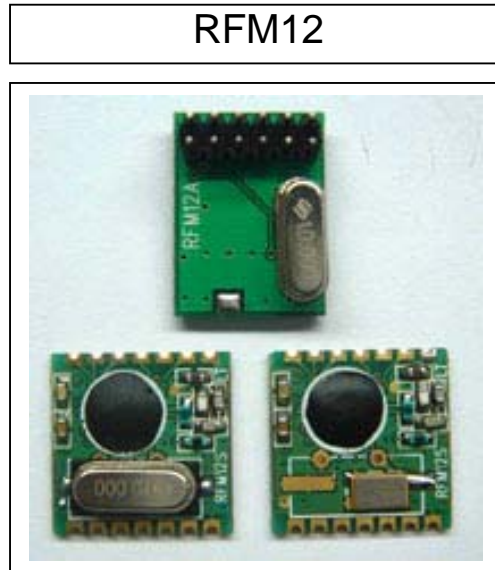

## Typical Application:

- Remote control
- Remote sensor
- Wireless data collection
- Home security system
- Toys
- Tire pressure monitoring system

## Pin Definition:

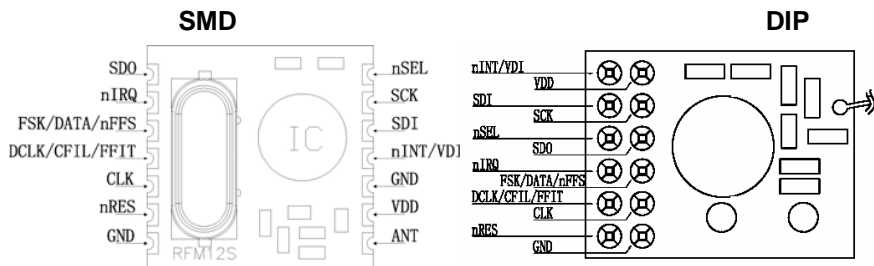

definition	Type	Function
nINT/VDI	DI/ DO	Interrupt input (active low)/Valid data indicator
VDD	S	Positive power supply
SDI	DI	SPI data input
SCK	DI	SPI clock input
nSEL	DI	Chip select (active low)
SDO	DO	Serial data output with bus hold
nIRQ	DO	Interrupts request output ( active low )
FSK/DATA/nFFS	DI/DO/DI	Transmit FSK data input/ Received data output (FIFO not used)/ FIFO select
DCLK/CFIL/FFIT	DO/AIO/DO	Clock output (no FIFO )/ external filter capacitor(analog mode)/ FIFO interrupts(active high)when FIFO level set to 1, FIFO empty interruption can be achieved
CLK	DO	Clock output for external microcontroller
nRES	DIO	Reset output ( active low )
GND	S	Power ground

## Electrical Parameter:

### Maximum (not at working mode)

symbol	parameter	minimum	maximum	Unit
V <sub>dd</sub>	Positive power supply	-0.5	6.0	V
V <sub>in</sub>	All pin input level	-0.5	V <sub>dd</sub> +0.5	V
I <sub>in</sub>	Input current except power	-25	25	mA
ESD	Human body model		1000	V
T <sub>st</sub>	Storage temperature	-55	125	°C
T <sub>ld</sub>	Soldering temperature(10s)		260	°C

### Recommended working range

symbol	parameter	minimum	maximum	Unit
V <sub>dd</sub>	Positive power supply	2.2	5.4	V
T <sub>op</sub>	Working temperature	-40	85	°C

### DC characteristic

symbol	parameter	Remark	minimum	typical	maximum	Unit
I <sub>dd_TX_0</sub>	Supply current (TX mode, P <sub>out</sub> = 0dBm)	315,433MHz band 868MHz band 915MHz band		13 16 17		mA
I <sub>dd_TX_PMAX</sub>	Supply current (TX mode, P <sub>out</sub> = P <sub>max</sub> )	315,433MHz band 868MHz band 915MHz band		21 24 25		mA
I <sub>dd_RX</sub>	Supply current (RX mode)	315,433MHz band 868MHz band 915MHz band		10 12 13		mA
I <sub>x</sub>	Stand by current	Crystal and base band on		3. 0	3. 5	mA
I <sub>pd</sub>	Sleep mode current	All blocks off		0.3		uA
I <sub>lb</sub>	Low battery detection			0.5		uA
V <sub>lb</sub>	Low battery step	0.1V per step	2.2		5.3	V
V <sub>lba</sub>	Low battery detection accuracy			75		mV
V <sub>il</sub>	Low level input				0.3*V <sub>dd</sub>	V
V <sub>ih</sub>	High level input		0.7*V <sub>dd</sub>			V
I <sub>il</sub>	Leakage current	V <sub>il</sub> =0V	-1		1	uA
I <sub>ih</sub>	Leakage current	V <sub>ih</sub> =V <sub>dd</sub> , V <sub>dd</sub> =5.4V	-1		1	uA
V <sub>ol</sub>	Low level output	I <sub>ol</sub> =2mA			0.4	V
V <sub>oh</sub>	High level output	I <sub>oh</sub> =-2mA	V <sub>dd</sub> -0.4			V

## AC characteristic

symbol	parameter	remark	min	typical	max	Unit
f <sub>ref</sub>	PLL frequency		8	10	12	MHz
f <sub>LO</sub>	frequency (10MHz crystal used)	315 MHz band,2.5KHz step 433 MHz band,2.5KHz step 868 MHz band,5KHz step 915 MHz band,7.5KHz step	310.24 430.24 860.48 900.72		319.75 439.75 879.51 929.27	MHz
f <sub>LO</sub>	frequency (8MHz crystal used)	315 MHz band,2.5KHz step 433 MHz band,2.5KHz step 868 MHz band,5KHz step 915 MHz band,7.5KHz step	248.19 344.19 688.38 720.57		255.80 351.80 703.61 743.41	MHz
f <sub>LO</sub>	frequency (12MHz crystal used)	315 MHz band,2.5KHz step 433 MHz band,2.5KHz step 868 MHz band,5KHz step 915 MHz band,7.5KHz step	372.28 516.28 1032.5 1080.8		383.71 527.71 1055.4 1115.1	MHz
BW	Receiver bandwidth	1 2 3 4 5 6	60 120 180 240 300 360	67 134 200 270 350 400	75 150 225 300 375 450	KHz
t <sub>lock</sub>	PLL lock time	After 10MHz step hopping, frequency error <10 kHz		20		us
BR	Data rate	With internal digital demodulator	0.6		115.2	kbps
BR <sub>A</sub>	Data rate	With external RC filter			256	kbps
P <sub>min</sub>	sensitivity	BW=134KHz, BR=1.2kbps		-102	-96	dBm
AFC <sub>range</sub>	AFC working range	df <sub>FSK</sub> FSK deviation in the received signal		0.8* df <sub>FSK</sub>		
RS <sub>A</sub>	RSSI accuracy			±5		dB
RS <sub>R</sub>	RSSI range			46		dB
C <sub>ARSSI</sub>	ARSSI filter			1		nF
RS <sub>STEP</sub>	RSSI programmable step			6		dB
RS <sub>RESP</sub>	DRSSI response time	RSSI output high after valid , CARRSI=5nF		500		us

## AC characteristic(Transmitter)

symbol	parameter	remark	min	typical	max	Unit
P <sub>max</sub>	Available output power with optimal antenna impedance	315/433MHz band 868/915MHz band		8 0		dbm
P <sub>out</sub>	Typical output power	Selectable in 3 dB steps	P <sub>max</sub> -21		P <sub>max</sub>	dbm

$C_o$	Output capacitance (set by the automatic antenna tuning circuit)	In low bands In high bands	2 2.1	2.6 2.7	3.2 3.3	pf
$Q_o$	Quality factor of the output capacitance	In low bands In high bands	13 8	15 10	17 12	
$L_{out}$	Output phase noise	100 kHz from carrier 1 MHz from carrier			-75 -85	dbc/HZ
BR	FSK bit rate				256	kbps
$df_{fsk}$	FSK frequency deviation	Programmable in 15 kHz steps	15		240	kHZ

### AC characteristic(Turn-on/Turnaround timings)

symbol	parameter	remark	min	typical	max	Unit
$T_{st}$	Crystal oscillator startup time	Crystal ESR < 100			5	ms
$T_{tx\_rx\_XTAL\_ON}$	Transmitter - Receiver turnover time	Synthesizer off, crystal oscillator on		450		us
$T_{rx\_tx\_XTAL\_ON}$	Receiver - Transmitter turnover time	Synthesizer off, crystal oscillator on		350		us
$T_{tx\_rx\_SYNT\_ON}$	Transmitter - Receiver turnover time	Synthesizer on, crystal oscillator on		425		us
$T_{rx\_tx\_SYNT\_ON}$	Receiver - Transmitter turnover time	Synthesizer on, crystal oscillator on		300		us
$C_{xl}$	Crystal load capacitance	Programmable in 0.5 pF steps, tolerance+/- 10%	8.5		16	pf
$t_{POR}$	Internal POR timeout	After $V_{dd}$ has reached 90% of final value			100	ms
$t_{PBt}$	Wake-up timer clock period	Calibrated every 30 seconds	0.96		1.05	ms
$C_{in,D}$	Digital input apacitance				2	pf
$t_{r,f}$	Digital output rise/fall time	15pF pure capacitive load			10	ns

### Field testing range

Band	Test condition	Distance
315MHz band	Receiver bandwidth=67KHz,data rate =1.2kbps,Transmitter frequency deviation =45KHZ ( matches with RFM12) in free open area	>100M
433MHz band	Receiver bandwidth =67KHz, data rate=1.2kbps, transmitter frequency deviation =45KHZ ( matches with RFM12) In free open area	>150M
868MHz band	Receiver bandwidth=67KHz,data rate =1.2kbps,Transmitter frequency deviation =45KHZ ( matches with RFM12) in free open area	>100M
915MHz band	Receiver bandwidth=67KHz,data rate =1.2kbps,Transmitter frequency deviation =45KHZ ( matches with RFM12) in free open area	>100M

Tel: +86-755-82973806 Fax: +86-755-82973550 E-mail: [sales@hoperf.com](mailto:sales@hoperf.com)  
<http://www.hoperf.com>

## SGS Reports

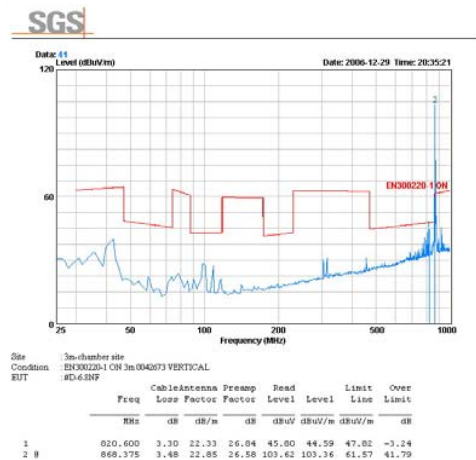
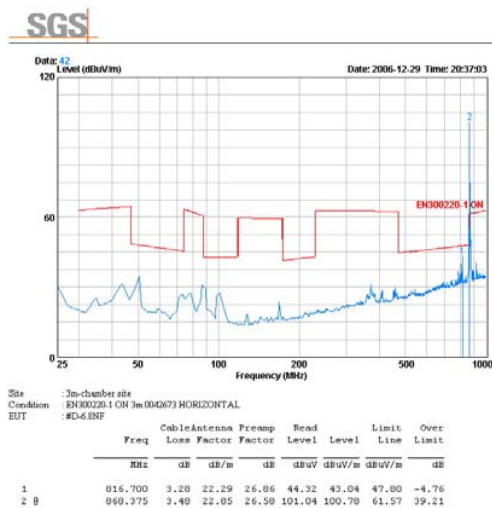
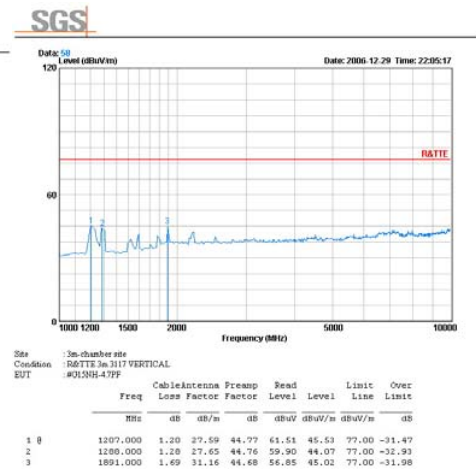
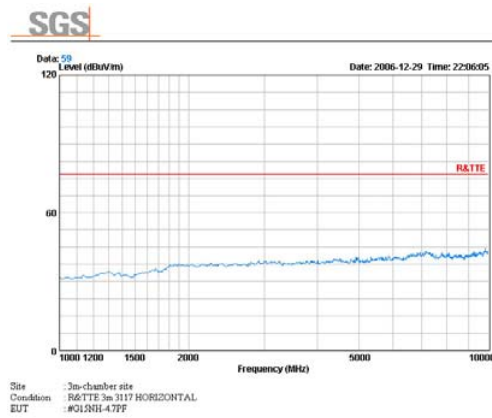
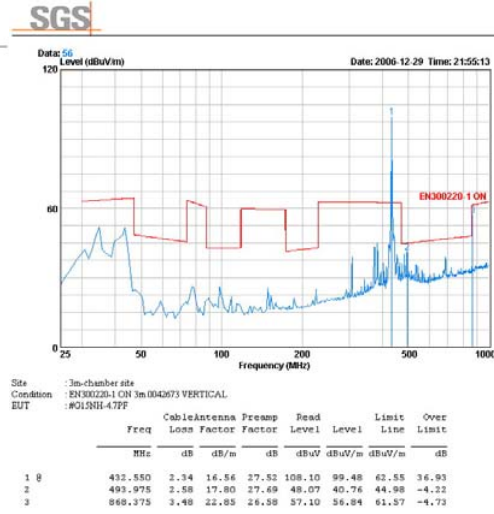
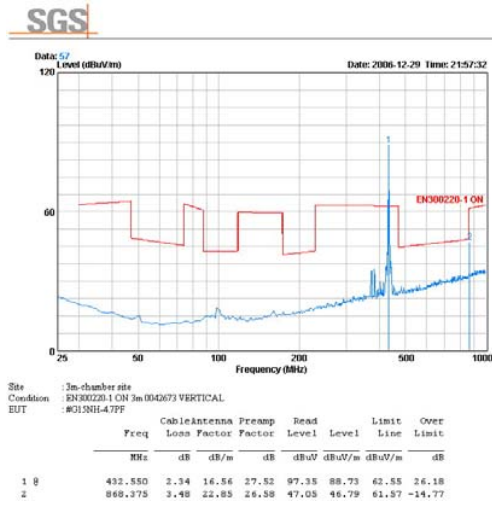

Tel: +86-755-82973806 Fax: +86-755-82973550 E-mail: [sales@hoperf.com](mailto:sales@hoperf.com)  
<http://www.hoperf.com>

SGS

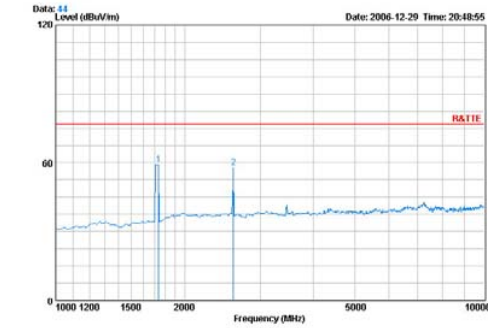

Site : 3m-chamber site  
Condition : R&TTE 3m 3117 HORIZONTAL  
EUT : #D-6.2NF

	Freq	Cable Loss	Antenna Factor	Preamp	Read Level	Limit Level	Over
	MHz	dB	dB/m	dB	dBuV	dBuV/m	dBuV/m
1	1738.000	1.60	29.94	44.70	72.33	59.18	77.00 -17.83
2	2602.000	2.04	32.54	44.80	67.95	57.73	77.00 -19.27

SGS

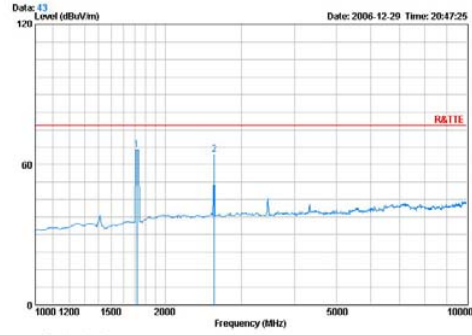

Site : 3m-chamber site  
Condition : R&TTE 3m 3117 VERTICAL  
EUT : #D-6.2NF

	Freq	Cable Loss	Antenna Factor	Preamp	Read Level	Limit Level	Over
	MHz	dB	dB/m	dB	dBuV	dBuV/m	dBuV/m
1	1720.000	1.59	29.82	44.70	79.69	66.40	77.00 -10.60
2	2602.000	2.04	32.54	44.80	74.74	64.52	77.00 -12.48

SGS

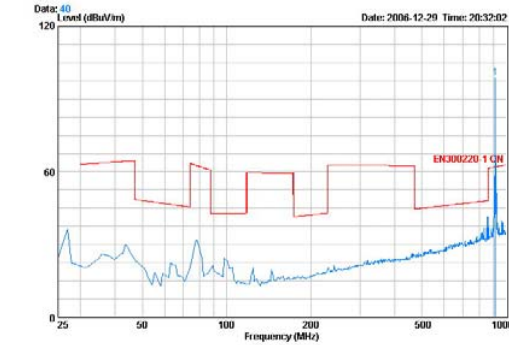

Site : 3m-chamber site  
Condition : EN300220-1 CN 3m 0042673 HORIZONTAL  
EUT : #F-6.2NF

	Freq	Cable Loss	Antenna Factor	Preamp	Read Level	Limit Level	Over
	MHz	dB	dB/m	dB	dBuV	dBuV/m	dBuV/m
1	914.200	3.62	23.26	26.43	90.20	90.73	62.05 36.60

SGS

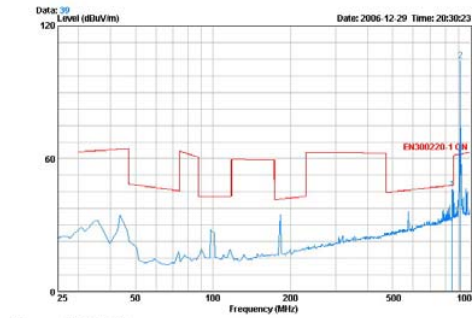

Site : 3m-chamber site  
Condition : EN300220-1 CN 3m 0042673 VERTICAL  
EUT : #F-6.2NF

	Freq	Cable Loss	Antenna Factor	Preamp	Read Level	Limit Level	Over
	MHz	dB	dB/m	dB	dBuV	dBuV/m	dBuV/m
1	851.600	3.42	22.40	26.67	46.75	45.98	49.03 -2.06
2	914.200	3.62	23.26	26.43	103.82	104.27	62.05 42.22

SGS

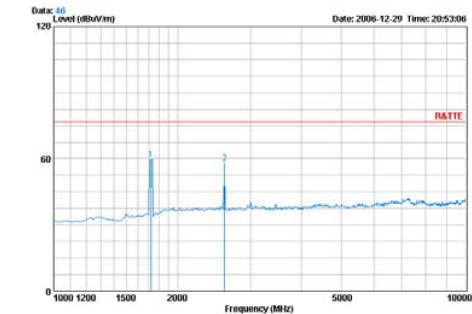

Site : 3m-chamber site  
Condition : R&TTE 3m 3117 HORIZONTAL  
EUT : #F-6.2NF

	Freq	Cable Loss	Antenna Factor	Preamp	Read Level	Limit Level	Over
	MHz	dB	dB/m	dB	dBuV	dBuV/m	dBuV/m
1	1720.000	1.59	29.82	44.70	72.95	59.63	77.00 -17.37
2	2602.000	2.04	32.54	44.80	67.94	57.72	77.00 -19.26

SGS

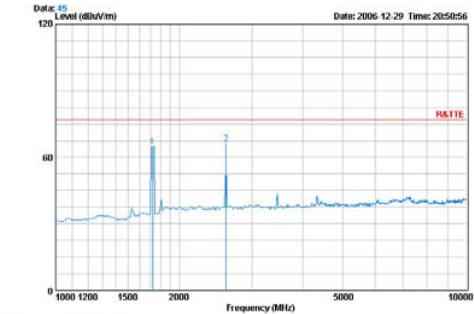

Site : 3m-chamber site  
Condition : R&TTE 3m 3117 VERTICAL  
EUT : #F-6.2NF

	Freq	Cable Loss	Antenna Factor	Preamp	Read Level	Limit Level	Over
	MHz	dB	dB/m	dB	dBuV	dBuV/m	dBuV/m
1	1720.000	1.59	29.82	44.70	78.10	64.80	77.00 -12.20
2	2602.000	2.04	32.54	44.80	76.30	66.08	77.00 -10.92

## Mechanical Dimension

(units in mm)

SMD PACKAGE (S1)

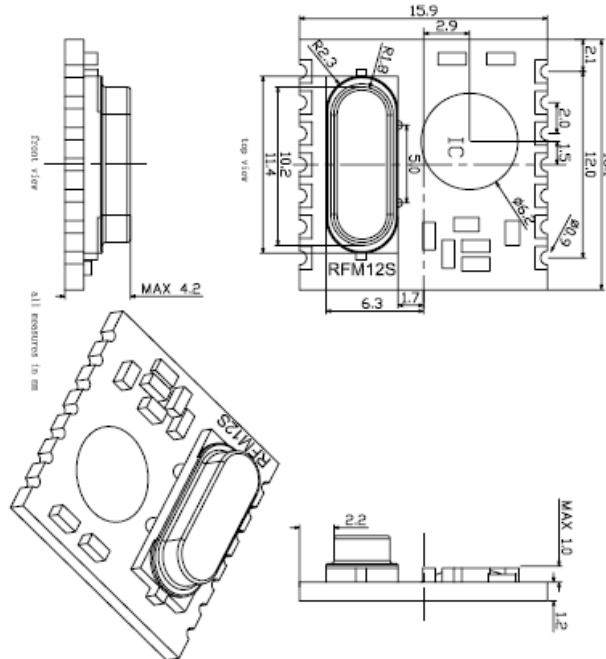

SMD PACKAGE (S2)

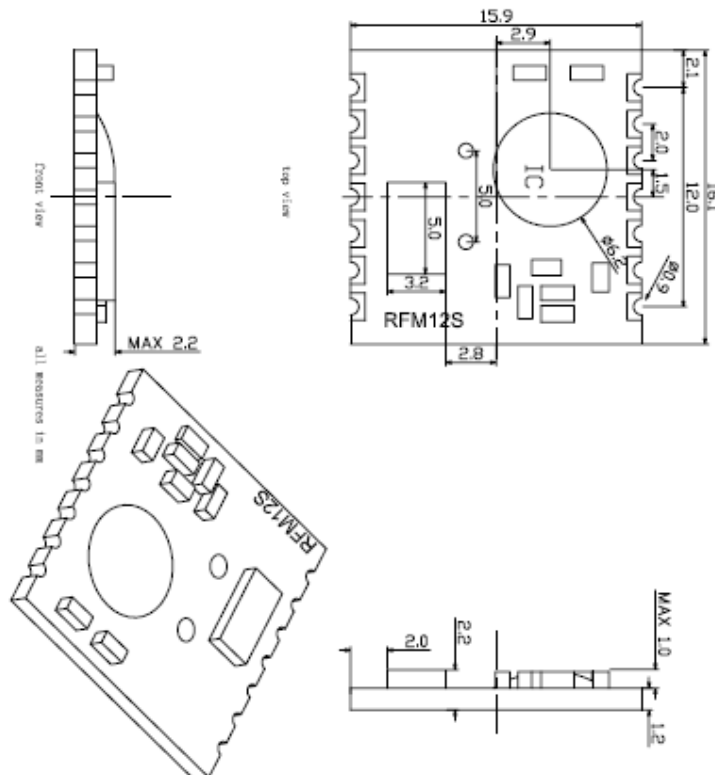



DIP PACKAGE (D)

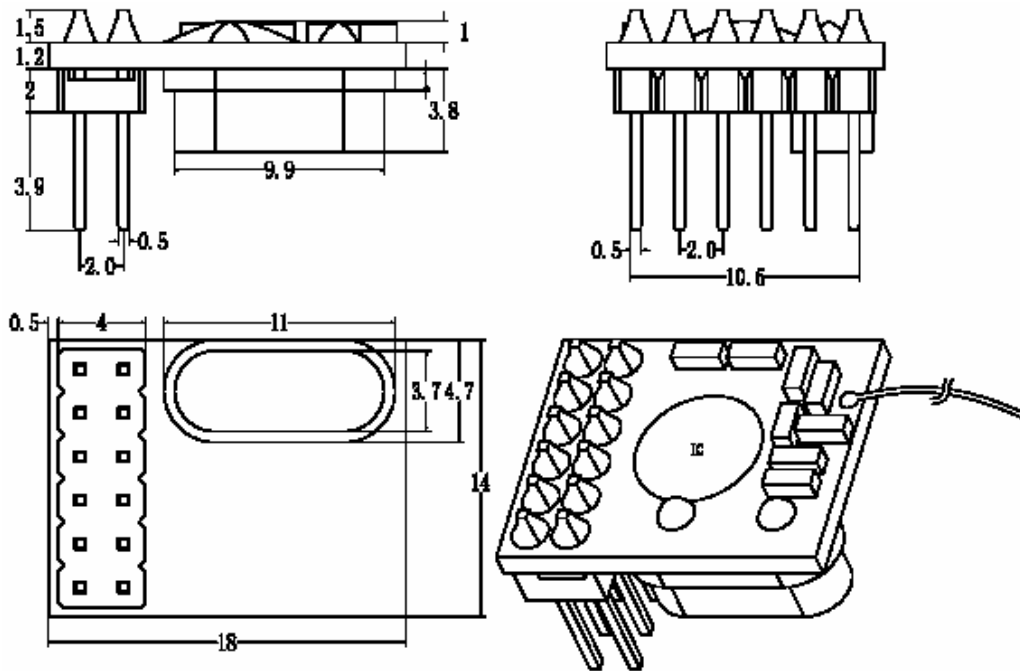

## Module Model Definition

model=module-operation band

**RFM12 - 433-D/S**

module type

operation band

Package

example: 1, RFM12 module at 433MHz band, DIP : RFM12-433-D.

2, RFM12 module at 868MHZ band, SMD, thickness at 4.2mm: RFM12-868-S1.

**HOPE MICROELECTRONICS CO.,LTD**

Rm B.8/F LiJingGe Emperor Regency 6012

ShenNan Rd., Shenzhen,China

Tel: 86-755-82973805

Fax: 86-755-82973550

Email: [sales@hoperf.com](mailto:sales@hoperf.com)

[trade@hoperf.com](mailto:trade@hoperf.com)

Website: <http://www.hoperf.com>

<http://hoperf.en.alibaba.com>

This document may contain preliminary information and is subject to change by Hope Microelectronics without notice. Hope Microelectronics assumes no responsibility or liability for any use of the information contained herein. Nothing in this document shall operate as an express or implied license or indemnity under the intellectual property rights of Hope Microelectronics or third parties. The products described in this document are not intended for use in implantation or other direct life support applications where malfunction may result in the direct physical harm or injury to persons. NO WARRANTIES OF ANY KIND, INCLUDING, BUT NOT LIMITED TO, THE IMPLIED WARRANTIES OF MECHANICALITY OR FITNESS FOR A PARTICULAR PURPOSE, ARE OFFERED IN THIS DOCUMENT.

©2006, HOPE MICROELECTRONICS CO.,LTD. All rights reserved.