



STPS8H100D/F/G/G-1

HIGH VOLTAGE POWER SCHOTTKY RECTIFIER

MAIN PRODUCT CHARACTERISTICS

$I_{F(AV)}$	8 A
V_{RRM}	100 V
$T_j(\text{max})$	175 °C
$V_F(\text{max})$	0.58 V

FEATURES AND BENEFITS

- NEGLIGIBLE SWITCHING LOSSES
- HIGH JUNCTION TEMPERATURE CAPABILITY
- LOW LEAKAGE CURRENT
- GOOD TRADE OFF BETWEEN LEAKAGE CURRENT AND FORWARD VOLTAGE DROP
- AVALANCHE RATED

DESCRIPTION

Schottky barrier rectifier designed for high frequency compact Switched Mode Power Supplies such as adaptators and on board DC/DC converters.

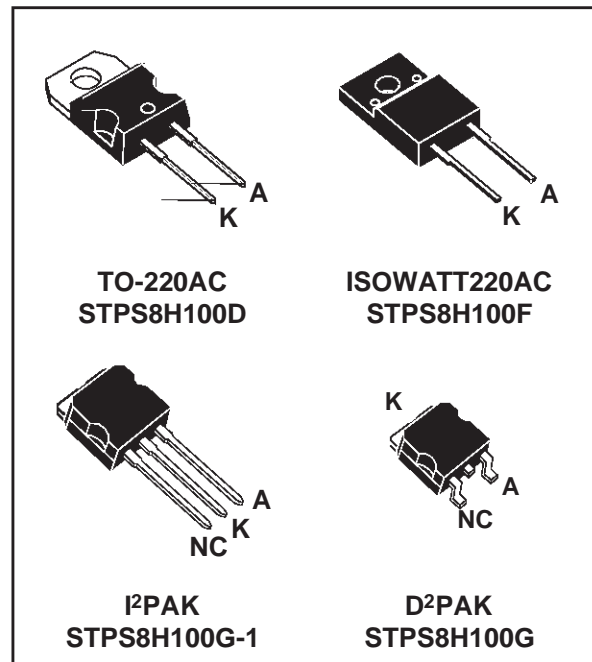

ABSOLUTE RATINGS (limiting values)

Symbol	Parameter		Value	Unit	
V_{RRM}	Repetitive peak reverse voltage		100	V	
$I_{F(RMS)}$	RMS forward current		30	A	
$I_{F(AV)}$	Average forward current $\delta = 0.5$	TO-220AC / I ² PAK / D ² PAK	$T_c = 165^\circ\text{C}$	8	A
		ISOWATT220AC	$T_c = 150^\circ\text{C}$		
I_{FSM}	Surge non repetitive forward current	tp = 10 ms sinusoidal		250	A
I_{RRM}	Repetitive peak reverse current	tp = 2 μs F = 1kHz square		1	A
I_{RSM}	Non repetitive peak reverse current	tp = 100 μs square		3	A
E_{as}	Non repetitive avalanche energy	$T_j = 25^\circ\text{C}$ L = 60 mH $I_{as} = 2$ A		24	mJ
I_{ar}	Repetitive avalanche current	$V_a = 1.5 \times V_R$ typ Current decaying linearly to 0 in 1 μs Frequency limited by T_j max.		2	A
T_{stg}	Storage temperature range		- 65 to + 175		°C
T_j	Maximum operating junction temperature		175		°C
dV/dt	Critical rate of rise of rise voltage		10000		V/ μs

STPS8H100D/F/G/G-1

THERMAL RESISTANCES

Symbol	Parameter		Value	Unit
$R_{th(j-c)}$	Junction to case	TO-220AC / I ² PAK / D ² PAK	1.6	°C/W
$R_{th(j-c)}$	Junction to case	ISOWATT220AC	4	°C/W

STATIC ELECTRICAL CHARACTERISTICS

Symbol	Parameter	Tests Conditions		Min.	Typ.	Max.	Unit
I_R^*	Reverse leakage current	$T_j = 25^\circ\text{C}$	$V_R = V_{RRM}$			4.5	μA
		$T_j = 125^\circ\text{C}$			2	6	mA
V_F^{**}	Forward voltage drop	$T_j = 25^\circ\text{C}$	$I_F = 8\text{ A}$			0.71	V
		$T_j = 25^\circ\text{C}$	$I_F = 10\text{ A}$			0.77	
		$T_j = 25^\circ\text{C}$	$I_F = 16\text{ A}$			0.81	
		$T_j = 125^\circ\text{C}$	$I_F = 8\text{ A}$		0.56	0.58	
		$T_j = 125^\circ\text{C}$	$I_F = 10\text{ A}$		0.59	0.64	
		$T_j = 125^\circ\text{C}$	$I_F = 16\text{ A}$		0.65	0.68	

Pulse test : * $t_p = 5\text{ ms}$, $\delta < 2\%$
 ** $t_p = 380\text{ }\mu\text{s}$, $\delta < 2\%$

To evaluate the maximum conduction losses use the following equation :

$$P = 0.48 \times I_{F(AV)} + 0.0125 \times I_{F(RMS)}^2$$

Fig. 1: Average forward power dissipation versus average forward current. (TO-220AC / ISOWATT220AC / I²PAK / D²PAK)

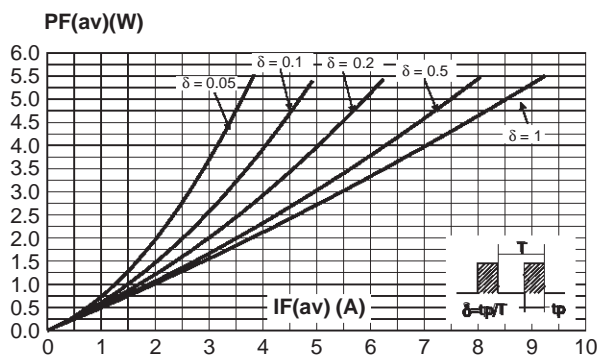

Fig. 2-1: Average forward current versus ambient temperature ($\delta=0.5$) (TO-220AC / I²PAK / D²PAK).

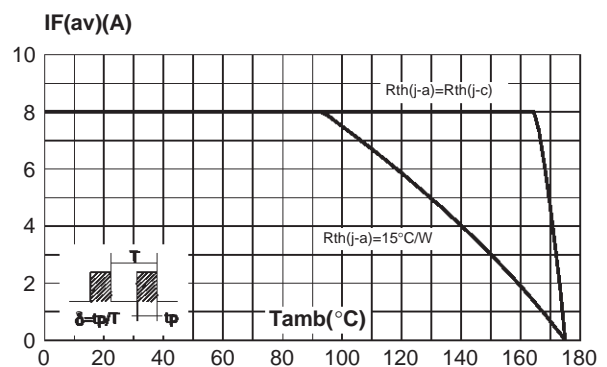

Fig. 2-2: Average forward current versus ambient temperature ($\delta=0.5$) (ISOWATT220AC).

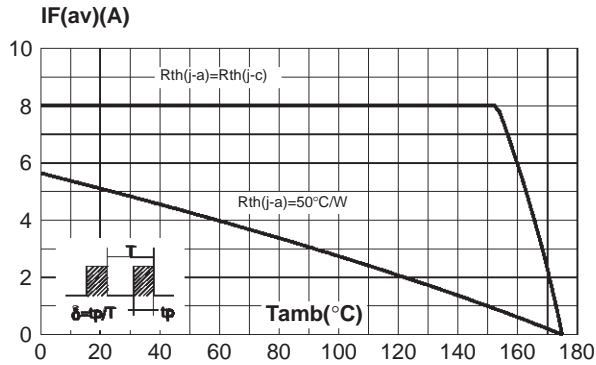

Fig. 3-1: Non repetitive surge peak forward current versus overload duration (maximum values) (TO-220AC / I²PAK / D²PAK).

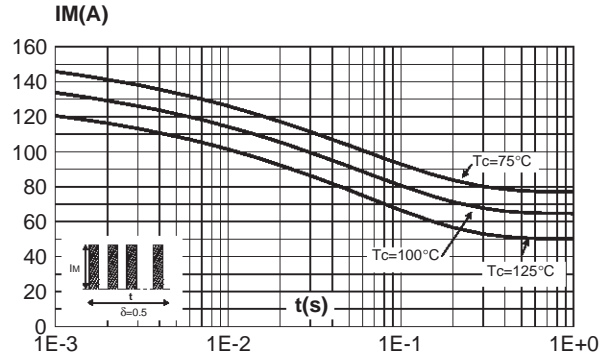

Fig. 3-2: Non repetitive surge peak forward current versus overload duration (maximum values) (ISOWATT220AC).

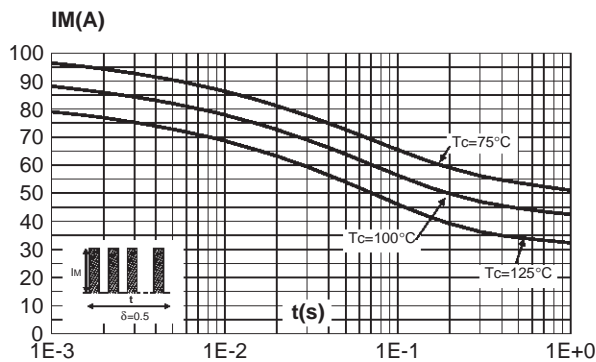

Fig. 4-1: Relative variation of thermal impedance junction to case versus pulse duration (TO-220AC / I²PAK / D²PAK).

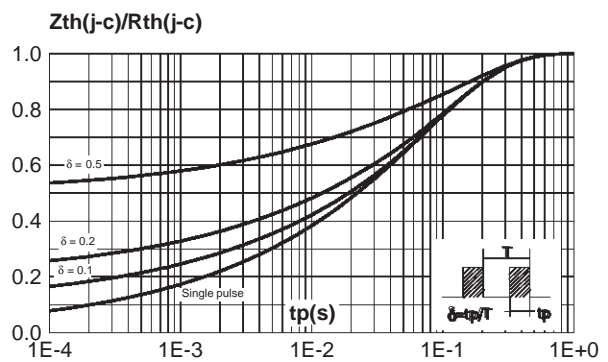

Fig. 4-2: Relative variation of thermal impedance junction to case versus pulse duration (ISOWATT220AC).

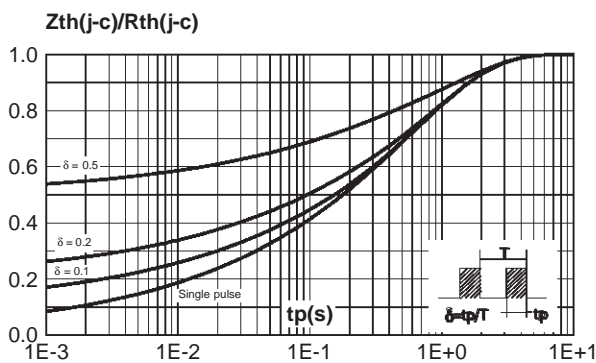

Fig. 5: Reverse leakage current versus reverse voltage applied (typical values).

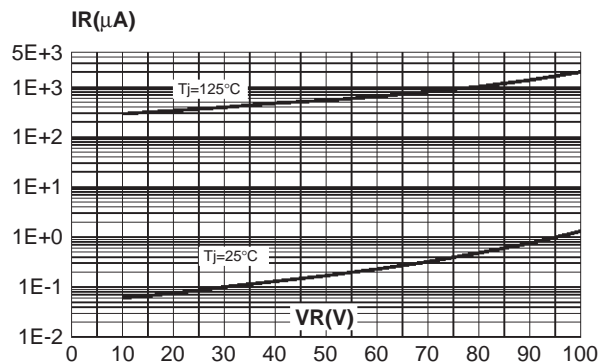

Fig. 6: Junction capacitance versus reverse voltage applied (typical values).

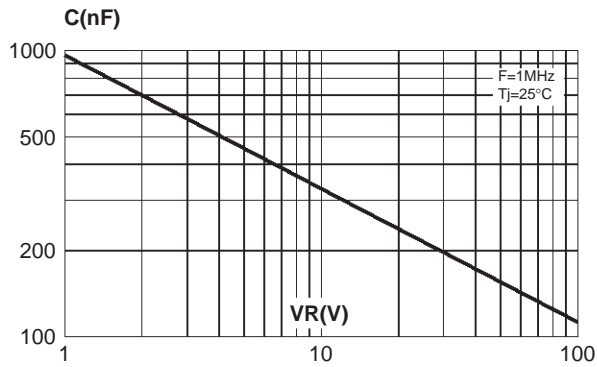

Fig. 7: Forward voltage drop versus forward current (maximum values).

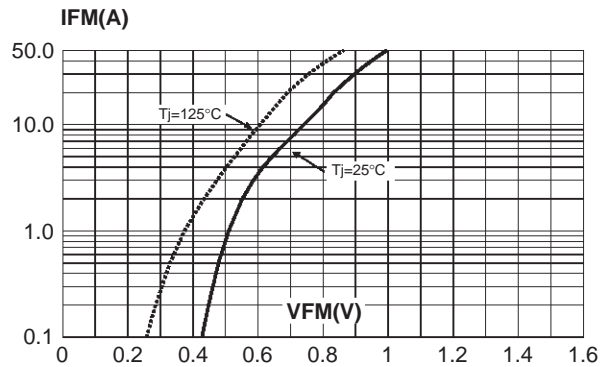
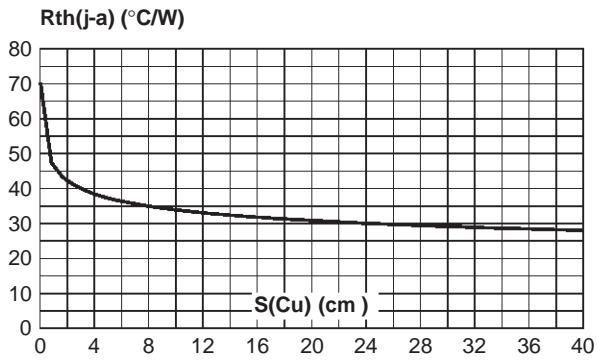
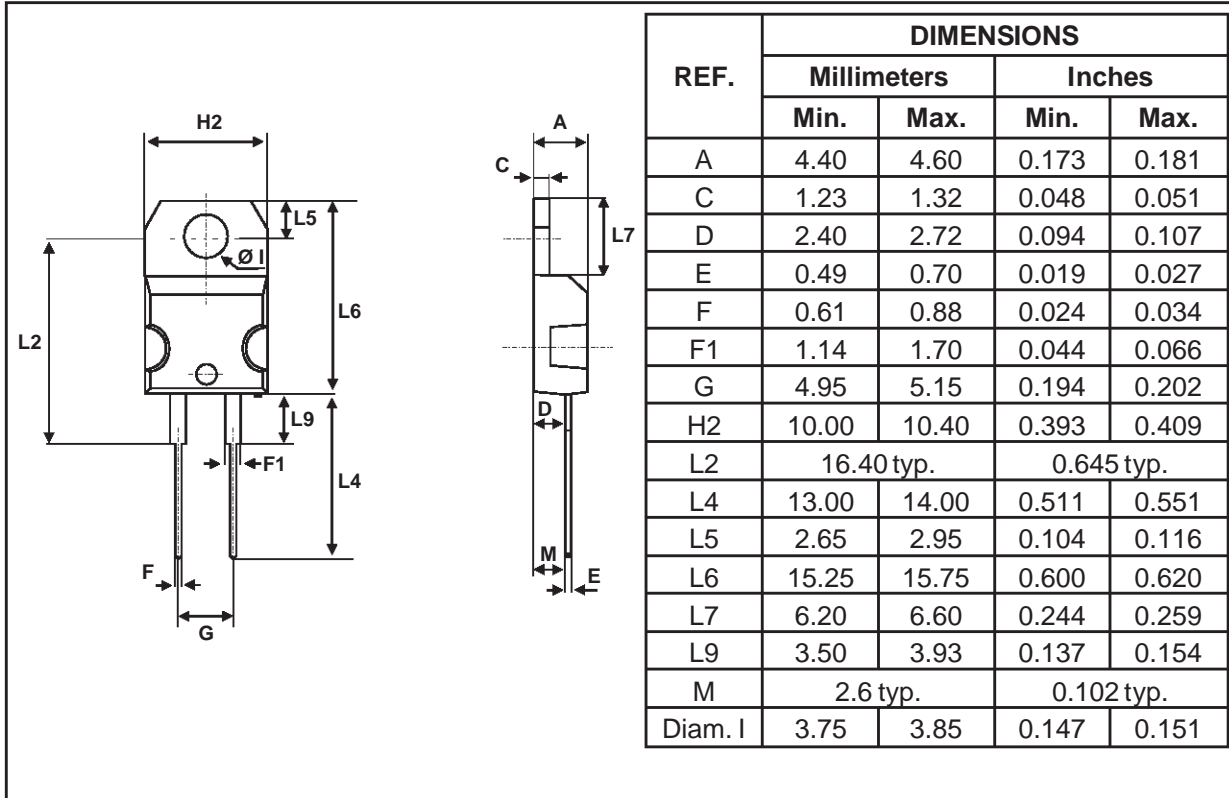

Fig. 8: Thermal resistance junction to ambient versus copper surface under tab (Epoxy printed circuit board FR4, copper thickness: 35μm)(D²PAK).



PACKAGE MECHANICAL DATA
TO-220AC



PACKAGE MECHANICAL DATA
ISOWATT220AC

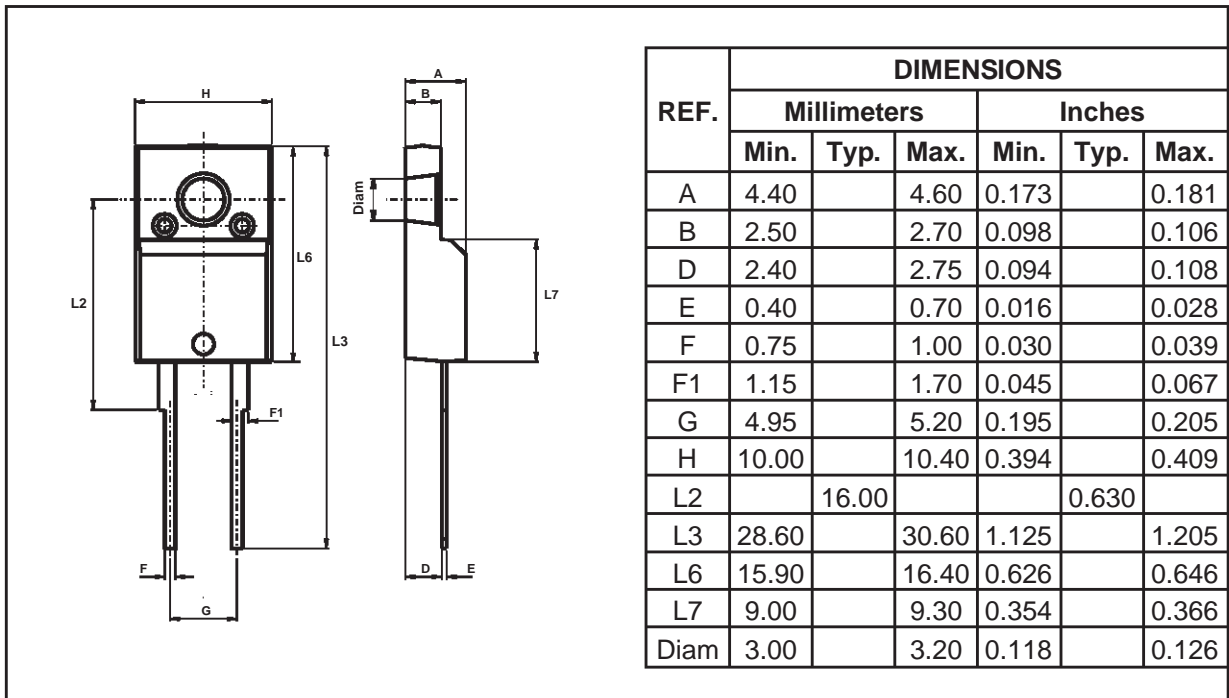

STPS8H100D/F/G/G-1

PACKAGE MECHANICAL DATA
D²PAK

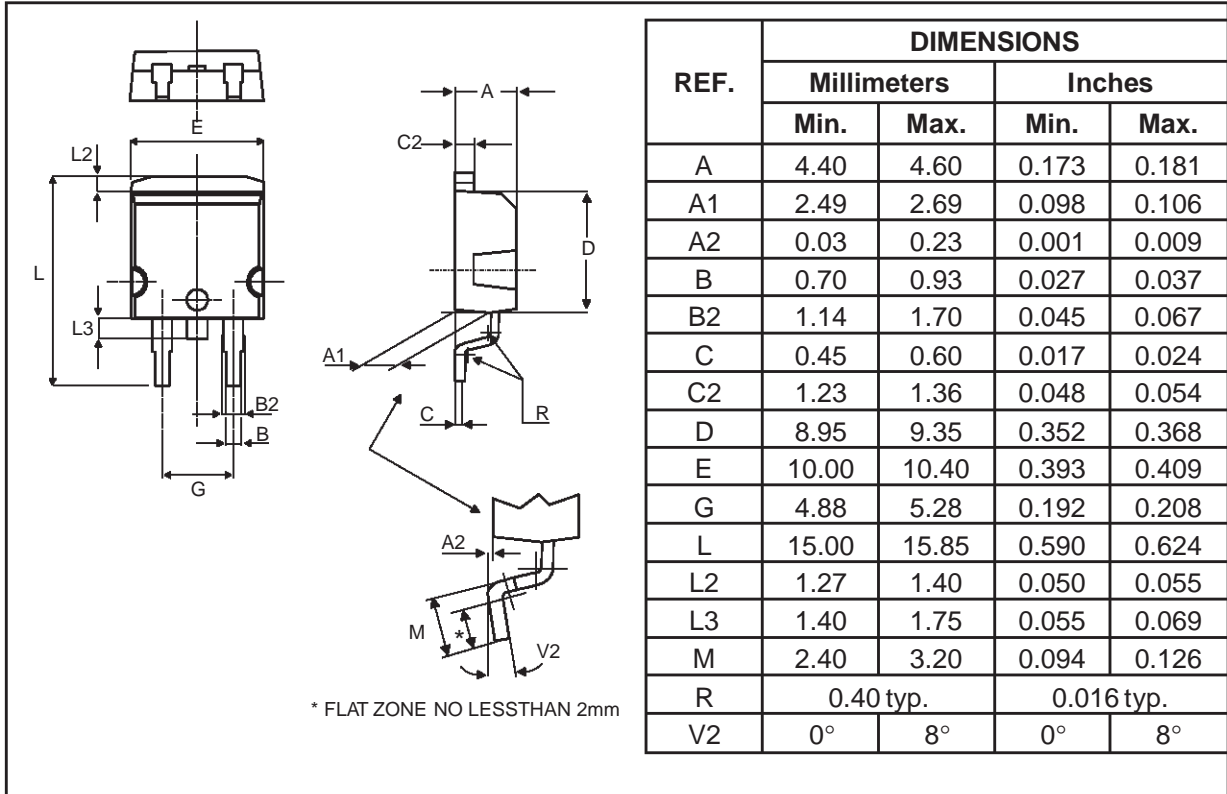

FOOTPRINT (in millimeters)D²PAK

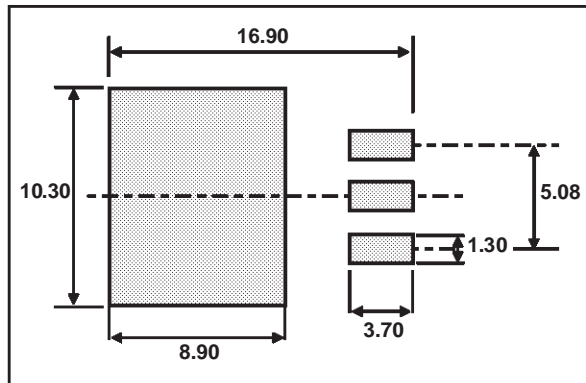

PACKAGE MECHANICAL DATA
I²PAK

REF.	DIMENSIONS			
	Millimeters		Inches	
	Min.	Max.	Min.	Max.
A	4.40	4.60	0.173	0.181
A1	2.49	2.69	0.098	0.106
b	0.70	0.93	0.028	0.037
b1	1.14	1.17	0.044	0.046
b2	1.14	1.17	0.044	0.046
c	0.45	0.60	0.018	0.024
c2	1.23	1.36	0.048	0.054
D	8.95	9.35	0.352	0.368
e	2.40	2.70	0.094	0.106
E	10.0	10.4	0.394	0.409
L	13.1	13.6	0.516	0.535
L1	3.48	3.78	0.137	0.149
L2	1.27	1.40	0.050	0.055

Ordering type	Marking	Package	Weight	Base qty	Delivery mode
STPS8H100D	STPS8H100D	TO-220AC	1.86g	50	Tube
STPS8H100F	STPS8H100F	ISOWATT220AC	2.00g	50	Tube
STPS8H100G-1	STPS8H100G	I ² PAK	1.49g	50	Tube
STPS8H100G	STPS8H100G	D ² PAK	1.48g	50	Tube
STPS8H100G-TR	STPS8H100G	D ² PAK	1.48g	500	Tape & reel

■ Epoxy meets UL94,V0

Information furnished is believed to be accurate and reliable. However, STMicroelectronics assumes no responsibility for the consequences of use of such information nor for any infringement of patents or other rights of third parties which may result from its use. No license is granted by implication or otherwise under any patent or patent rights of STMicroelectronics. Specifications mentioned in this publication are subject to change without notice. This publication supersedes and replaces all information previously supplied. STMicroelectronics products are not authorized for use as critical components in life support devices or systems without express written approval of STMicroelectronics.

The ST logo is a registered trademark of STMicroelectronics

© 1999 STMicroelectronics - Printed in Italy - All rights reserved.

STMicroelectronics GROUP OF COMPANIES

Australia - Brazil - China - Finland - France - Germany - Hong Kong - India - Italy - Japan - Malaysia
 Malta - Morocco - Singapore - Spain - Sweden - Switzerland - United Kingdom - U.S.A.

<http://www.st.com>