

MUR1610CTG, MUR1615CTG, MUR1620CTG, MUR1640CTG, MUR1660CTG

Switch Mode Power Rectifiers

These state-of-the-art devices are a series designed for use in switching power supplies, inverters and as free wheeling diodes.

Features

- Ultrafast 35 and 60 Nanosecond Recovery Times
- 175°C Operating Junction Temperature
- Popular TO-220 Package
- Epoxy Meets UL 94 V-0 @ 0.125 in
- High Temperature Glass Passivated Junction
- High Voltage Capability to 600 V
- Low Leakage Specified @ 150°C Case Temperature
- Current Derating @ Both Case and Ambient Temperatures
- These are Pb-Free Devices*

Mechanical Characteristics:

- Case: Epoxy, Molded
- Weight: 1.9 Grams (Approximately)
- Finish: All External Surfaces Corrosion Resistant and Terminal Leads are Readily Solderable
- Lead Temperature for Soldering Purposes:
260°C Max. for 10 Seconds



ON Semiconductor®

www.onsemi.com

ULTRAFAST RECTIFIERS 16 AMPERES, 100-600 VOLTS

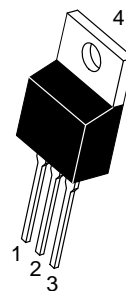
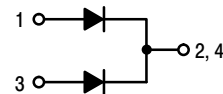

TO-220AB
CASE 221A-09

MARKING DIAGRAM

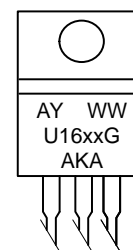

- A = Assembly Location
- Y = Year
- WW = Work Week
- U16xx = Device Code
xx = 10, 15, 20, 40 or 60
- G = Pb-Free Package
- KA = Diode Polarity

*For additional information on our Pb-Free strategy and soldering details, please download the ON Semiconductor Soldering and Mounting Techniques Reference Manual, SOLDERRM/D.

ORDERING INFORMATION

See detailed ordering and shipping information in the package dimensions section on page 6 of this data sheet.

MUR1610CTG, MUR1615CTG, MUR1620CTG, MUR1640CTG, MUR1660CTG

MAXIMUM RATINGS

| Rating | Symbol | MUR16 | | | | | Unit |
|--|--|-------------|------|------|------|------|------------------|
| | | 10CT | 15CT | 20CT | 40CT | 60CT | |
| Peak Repetitive Reverse Voltage Working Peak Reverse Voltage DC Blocking Voltage | V_{RRM} V_{RWM} V_R | 100 | 150 | 200 | 400 | 600 | V |
| Average Rectified Forward Current Total Device, (Rated V_R), $T_C = 150^\circ\text{C}$ | $I_{F(AV)}$ Per Leg Total Device | 8.0 16 | | | | | A |
| Peak Rectified Forward Current (Rated V_R , Square Wave, 20 kHz), $T_C = 150^\circ\text{C}$ | I_{FM} Per Diode Leg | 16 | | | | | A |
| Nonrepetitive Peak Surge Current (Surge applied at rated load conditions halfwave, single phase, 60 Hz) | I_{FSM} | 100 | | | | | A |
| Operating Junction Temperature and Storage Temperature | T_J, T_{stg} | -65 to +175 | | | | | $^\circ\text{C}$ |

Stresses exceeding those listed in the Maximum Ratings table may damage the device. If any of these limits are exceeded, device functionality should not be assumed, damage may occur and reliability may be affected.

THERMAL CHARACTERISTICS (Per Diode Leg)

| Parameter | Symbol | Value | | Unit |
|--|-----------------|-------|-----|--------------------|
| Maximum Thermal Resistance, Junction-to-Case | $R_{\theta JC}$ | 3.0 | 2.0 | $^\circ\text{C/W}$ |

ELECTRICAL CHARACTERISTICS (Per Diode Leg)

| Characteristic | Symbol | 1620 | 1640 | 1660 | Unit |
|--|----------|----------------|--------------|--------------|---------------|
| Maximum Instantaneous Forward Voltage (Note 1) ($I_F = 8.0\text{ A}$, $T_C = 150^\circ\text{C}$) ($I_F = 8.0\text{ A}$, $T_C = 25^\circ\text{C}$) | V_F | 0.895 0.975 | 1.00 1.30 | 1.20 1.50 | V |
| Maximum Instantaneous Reverse Current (Note 1) (Rated DC Voltage, $T_C = 150^\circ\text{C}$) (Rated DC Voltage, $T_C = 25^\circ\text{C}$) | i_R | 250 5.0 | 500 10 | | μA |
| Maximum Reverse Recovery Time ($I_F = 1.0\text{ A}$, $di/dt = 50\text{ A}/\mu\text{s}$) ($I_F = 0.5\text{ A}$, $I_R = 1.0\text{ A}$, $I_{REC} = 0.25\text{ A}$) | t_{rr} | 35 25 | 60 50 | | ns |

Product parametric performance is indicated in the Electrical Characteristics for the listed test conditions, unless otherwise noted. Product performance may not be indicated by the Electrical Characteristics if operated under different conditions.

1. Pulse Test: Pulse Width = 300 μs , Duty Cycle $\leq 2.0\%$

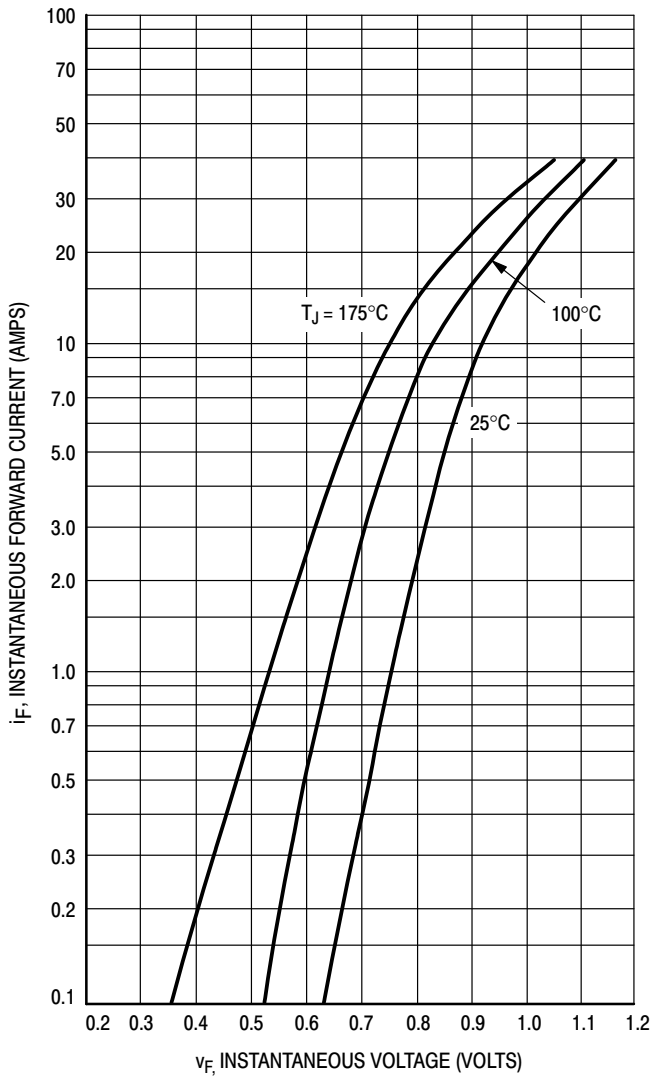

Figure 1. Typical Forward Voltage, Per Leg

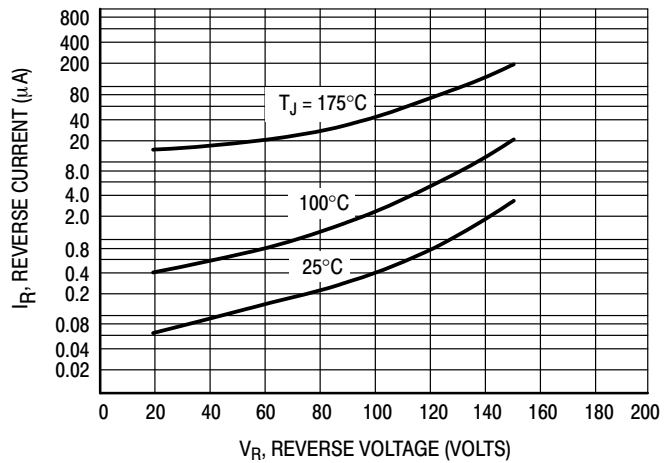

Figure 2. Typical Reverse Current, Per Leg*

* The curves shown are typical for the highest voltage device in the voltage grouping. Typical reverse current for lower voltage selections can be estimated from these same curves if V_R is sufficiently below rated V_R .

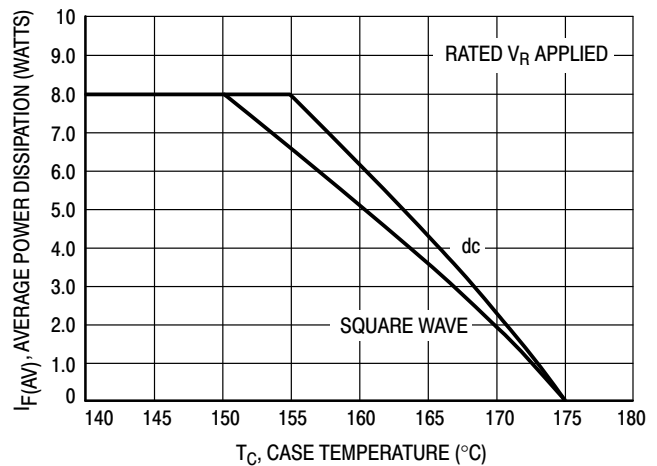

Figure 3. Current Derating, Case, Per Leg

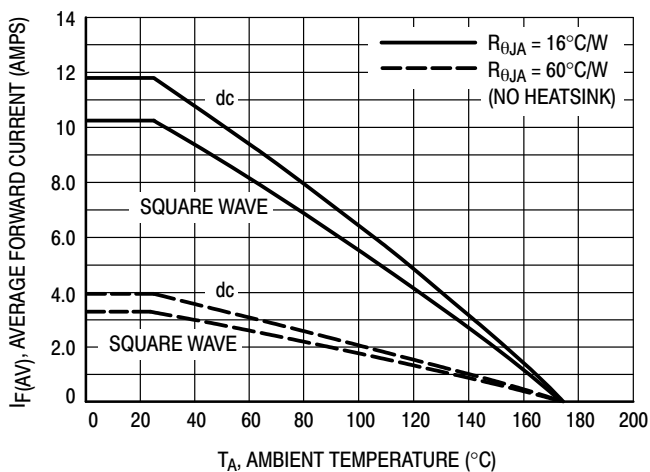

Figure 4. Current Derating, Ambient, Per Leg

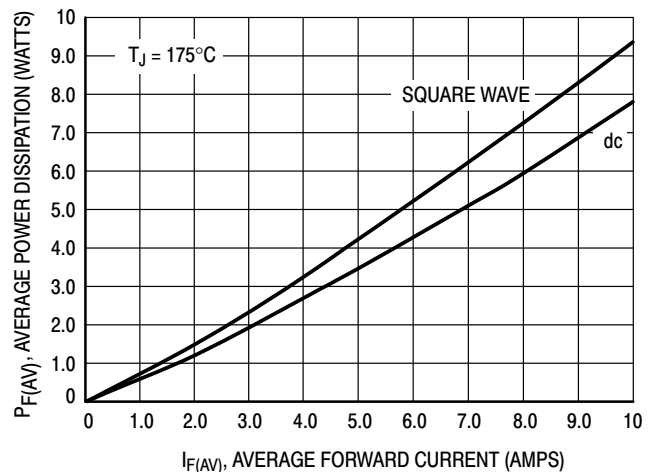

Figure 5. Power Dissipation, Per Leg

MUR1640CT

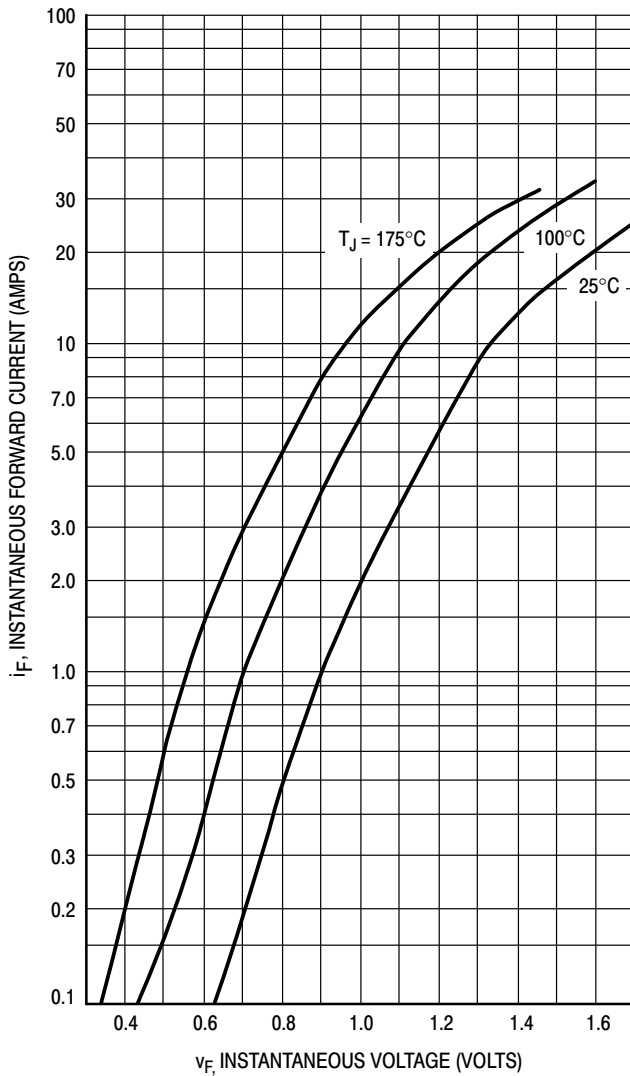

Figure 6. Typical Forward Voltage, Per Leg

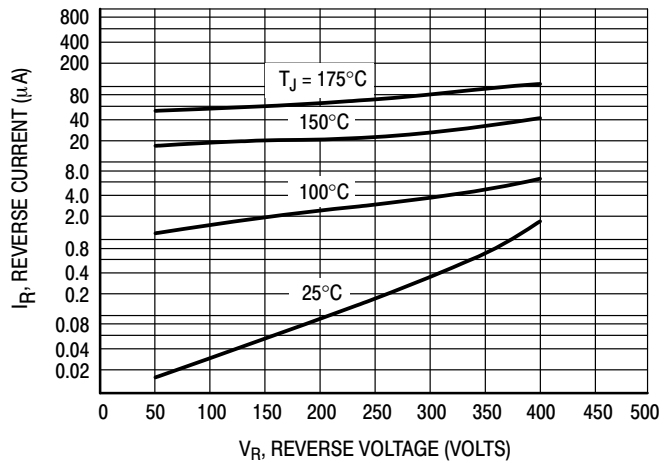

Figure 7. Typical Reverse Current, Per Leg*

* The curves shown are typical for the highest voltage device in the voltage grouping. Typical reverse current for lower voltage selections can be estimated from these curves if V_R is sufficiently below rated V_R .

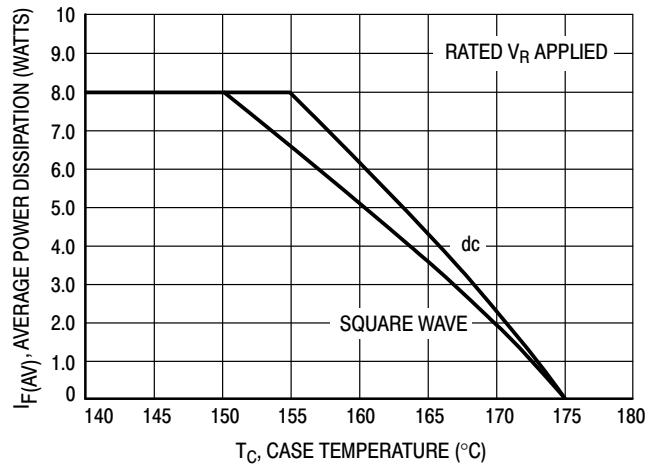

Figure 8. Current Derating, Case, Per Leg

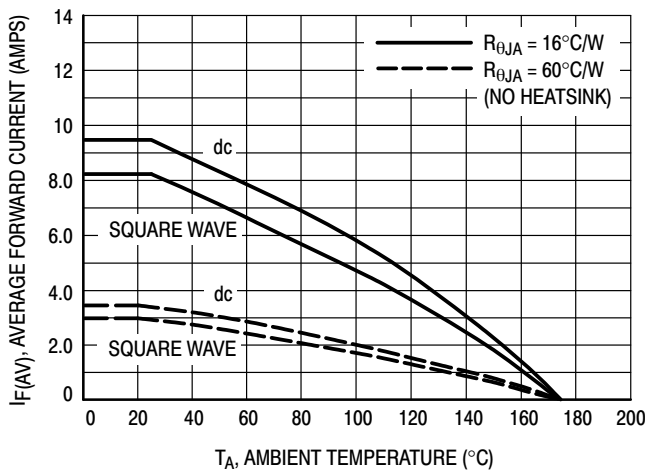

Figure 9. Current Derating, Ambient, Per Leg

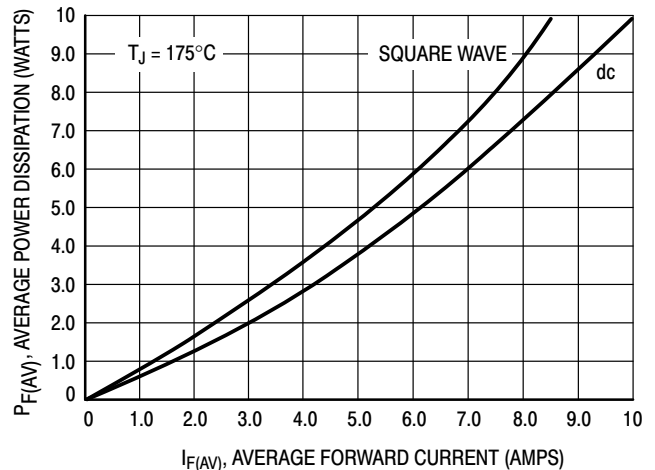

Figure 10. Power Dissipation, Per Leg

MUR1660CT

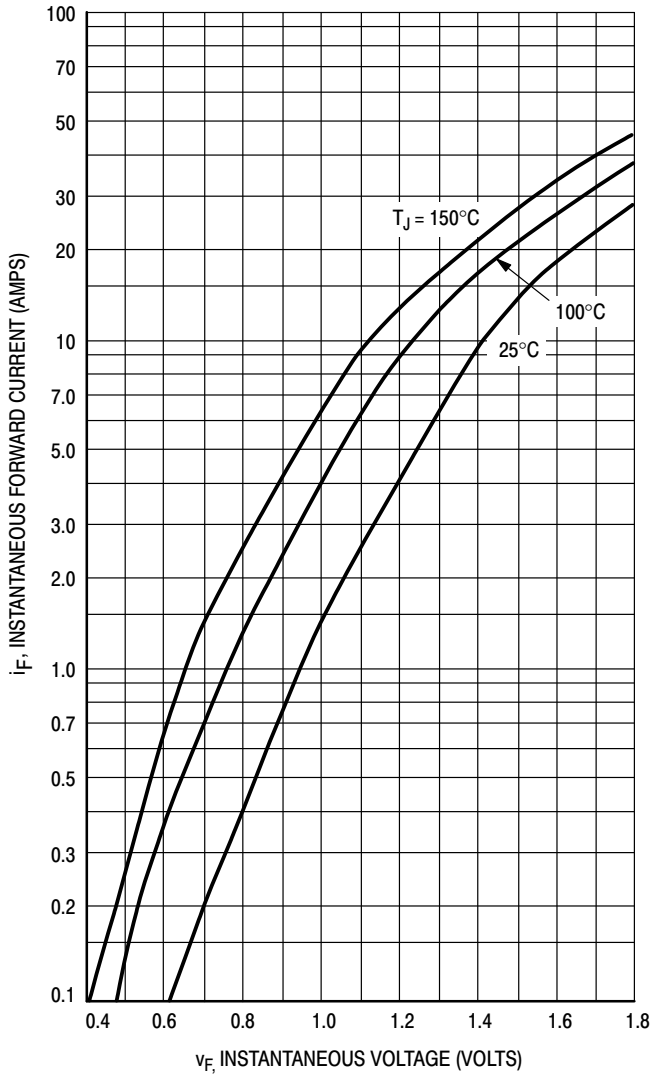

Figure 11. Typical Forward Voltage, Per Leg

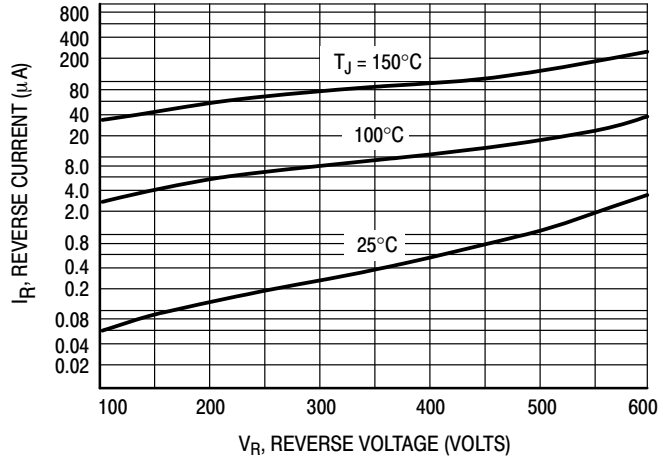

Figure 12. Typical Reverse Current, Per Leg*

* The curves shown are typical for the highest voltage device in the voltage grouping. Typical reverse current for lower voltage selections can be estimated from these same curves if V_R is sufficiently below rated V_R .

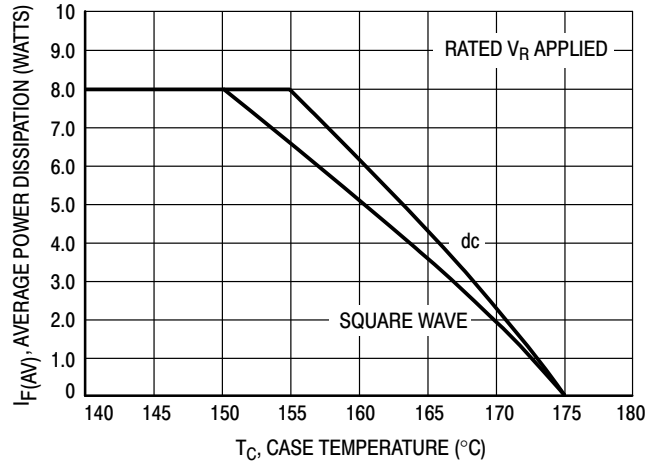

Figure 13. Current Derating, Case, Per Leg

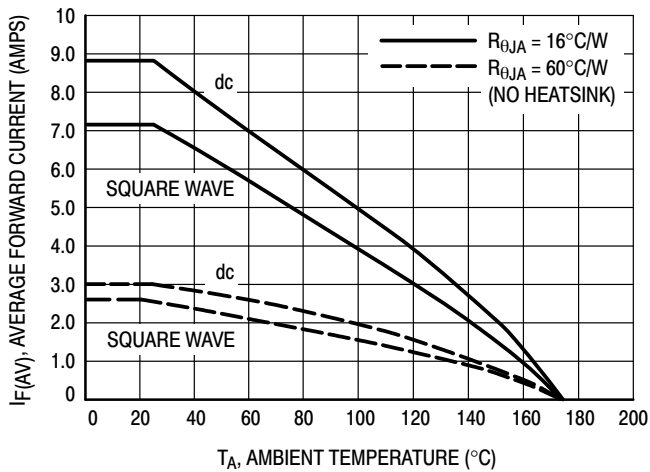

Figure 14. Current Derating, Ambient, Per Leg

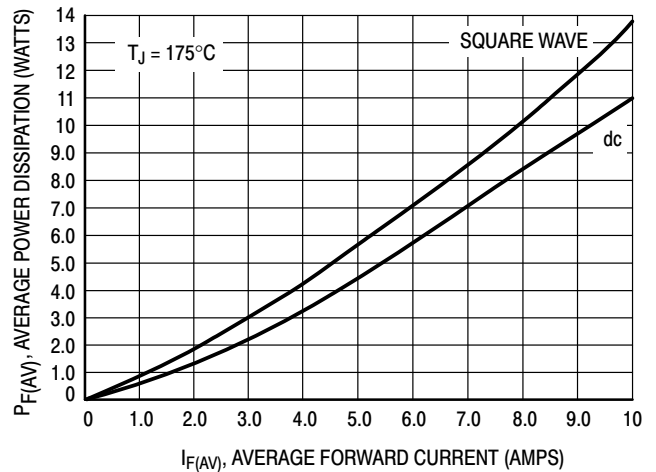

Figure 15. Power Dissipation, Per Leg

MUR1610CTG, MUR1615CTG, MUR1620CTG, MUR1640CTG, MUR1660CTG

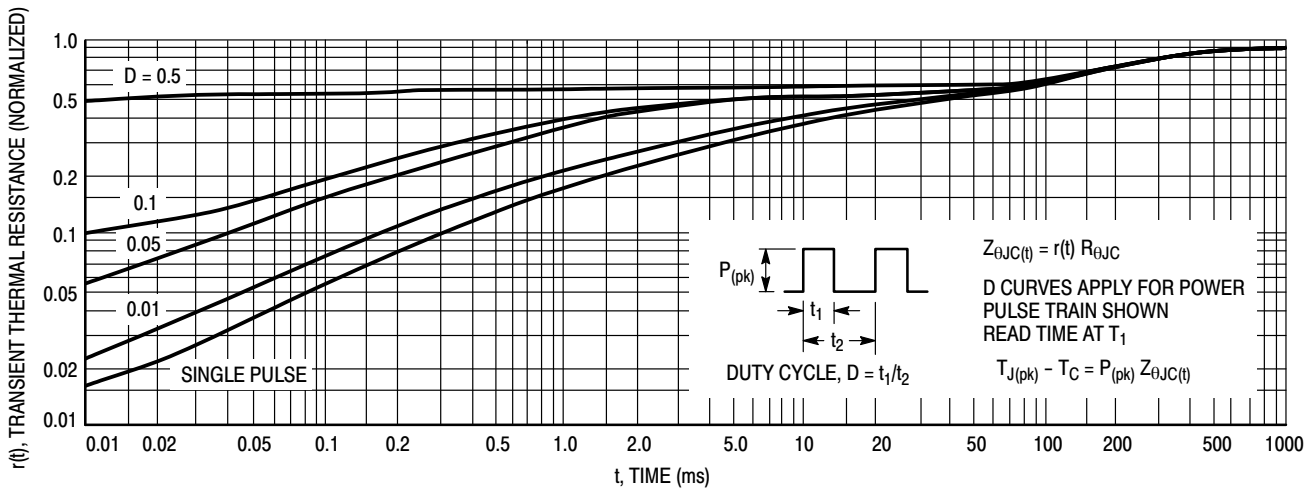

Figure 16. Thermal Response

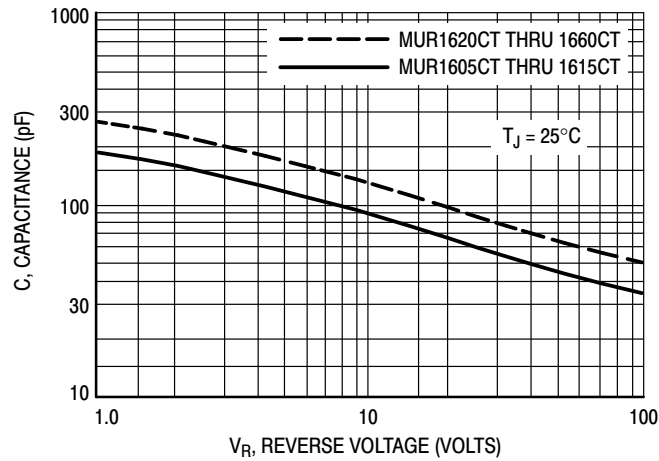

Figure 17. Typical Capacitance, Per Leg

ORDERING INFORMATION

| Device | Package | Shipping† |
|------------|---------------------|-----------------|
| MUR1610CTG | TO-220 (Pb-Free) | 50 Units / Rail |
| MUR1615CTG | TO-220 (Pb-Free) | |
| MUR1620CTG | TO-220 (Pb-Free) | |
| MUR1640CTG | TO-220 (Pb-Free) | |
| MUR1660CTG | TO-220 (Pb-Free) | |

†For information on tape and reel specifications, including part orientation and tape sizes, please refer to our Tape and Reel Packaging Specifications Brochure, BRD8011/D.

MECHANICAL CASE OUTLINE PACKAGE DIMENSIONS

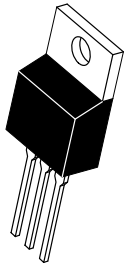

SCALE 1:1

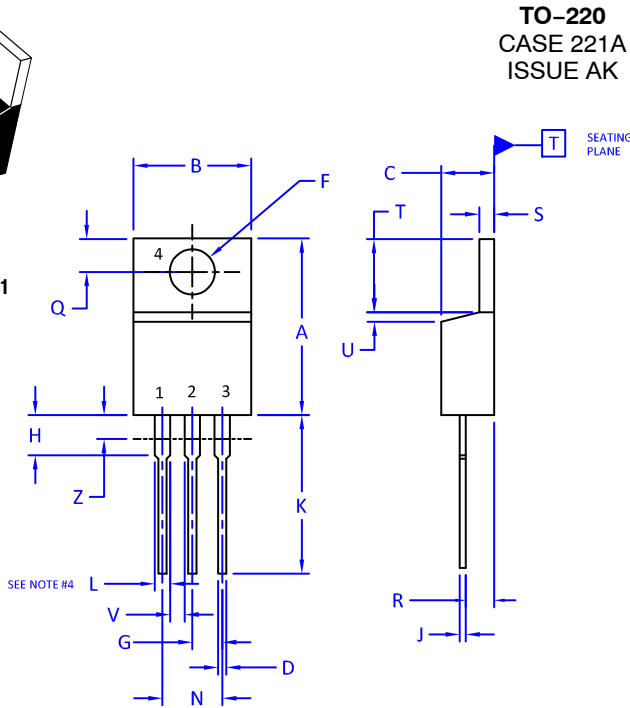

TO-220 CASE 221A ISSUE AK

DATE 13 JAN 2022

NOTES:

1. DIMENSIONING AND TOLERANCING PER ANSI Y14.5M, 2009.
2. CONTROLLING DIMENSION: INCHES
3. DIMENSION Z DEFINES A ZONE WHERE ALL BODY AND LEAD IRREGULARITIES ARE ALLOWED.
4. MAX WIDTH FOR F102 DEVICE = 1.35MM

| DIM | INCHES | | MILLIMETERS | |
|-----|--------|-------|-------------|-------|
| | MIN. | MAX. | MIN. | MAX. |
| A | 0.570 | 0.620 | 14.48 | 15.75 |
| B | 0.380 | 0.415 | 9.66 | 10.53 |
| C | 0.160 | 0.190 | 4.07 | 4.83 |
| D | 0.025 | 0.038 | 0.64 | 0.96 |
| F | 0.142 | 0.161 | 3.60 | 4.09 |
| G | 0.095 | 0.105 | 2.42 | 2.66 |
| H | 0.110 | 0.161 | 2.80 | 4.10 |
| J | 0.014 | 0.024 | 0.36 | 0.61 |
| K | 0.500 | 0.562 | 12.70 | 14.27 |
| L | 0.045 | 0.060 | 1.15 | 1.52 |
| N | 0.190 | 0.210 | 4.83 | 5.33 |
| Q | 0.100 | 0.120 | 2.54 | 3.04 |
| R | 0.080 | 0.110 | 2.04 | 2.79 |
| S | 0.045 | 0.055 | 1.15 | 1.41 |
| T | 0.235 | 0.255 | 5.97 | 6.47 |
| U | 0.000 | 0.050 | 0.00 | 1.27 |
| V | 0.045 | --- | 1.15 | --- |
| Z | --- | 0.080 | --- | 2.04 |

STYLE 1:

- PIN 1. BASE
- 2. COLLECTOR
- 3. EMITTER
- 4. COLLECTOR

STYLE 2:

- PIN 1. BASE
- 2. EMITTER
- 3. COLLECTOR
- 4. EMITTER

STYLE 3:

- PIN 1. CATHODE
- 2. ANODE
- 3. GATE
- 4. ANODE

STYLE 4:

- PIN 1. MAIN TERMINAL 1
- 2. MAIN TERMINAL 2
- 3. GATE
- 4. MAIN TERMINAL 2

STYLE 5:

- PIN 1. GATE
- 2. DRAIN
- 3. SOURCE
- 4. DRAIN

STYLE 6:

- PIN 1. ANODE
- 2. CATHODE
- 3. ANODE
- 4. CATHODE

STYLE 7:

- PIN 1. CATHODE
- 2. ANODE
- 3. CATHODE
- 4. ANODE

STYLE 8:

- PIN 1. CATHODE
- 2. ANODE
- 3. EXTERNAL TRIP/DELAY
- 4. ANODE

STYLE 9:

- PIN 1. GATE
- 2. COLLECTOR
- 3. EMITTER
- 4. COLLECTOR

STYLE 10:

- PIN 1. GATE
- 2. SOURCE
- 3. DRAIN
- 4. SOURCE

STYLE 11:

- PIN 1. DRAIN
- 2. SOURCE
- 3. GATE
- 4. SOURCE

STYLE 12:

- PIN 1. MAIN TERMINAL 1
- 2. MAIN TERMINAL 2
- 3. GATE
- 4. NOT CONNECTED

| | | |
|------------------|-------------|--|
| DOCUMENT NUMBER: | 98ASB42148B | Electronic versions are uncontrolled except when accessed directly from the Document Repository. Printed versions are uncontrolled except when stamped "CONTROLLED COPY" in red. |
| DESCRIPTION: | TO-220 | PAGE 1 OF 1 |

onsemi and onsemi are trademarks of Semiconductor Components Industries, LLC dba onsemi or its subsidiaries in the United States and/or other countries. onsemi reserves the right to make changes without further notice to any products herein. onsemi makes no warranty, representation or guarantee regarding the suitability of its products for any particular purpose, nor does onsemi assume any liability arising out of the application or use of any product or circuit, and specifically disclaims any and all liability, including without limitation special, consequential or incidental damages. onsemi does not convey any license under its patent rights nor the rights of others.

onsemi, **Onsemi**, and other names, marks, and brands are registered and/or common law trademarks of Semiconductor Components Industries, LLC dba "**onsemi**" or its affiliates and/or subsidiaries in the United States and/or other countries. **onsemi** owns the rights to a number of patents, trademarks, copyrights, trade secrets, and other intellectual property. A listing of **onsemi**'s product/patent coverage may be accessed at www.onsemi.com/site/pdf/Patent-Marking.pdf. **onsemi** reserves the right to make changes at any time to any products or information herein, without notice. The information herein is provided "as-is" and **onsemi** makes no warranty, representation or guarantee regarding the accuracy of the information, product features, availability, functionality, or suitability of its products for any particular purpose, nor does **onsemi** assume any liability arising out of the application or use of any product or circuit, and specifically disclaims any and all liability, including without limitation special, consequential or incidental damages. Buyer is responsible for its products and applications using **onsemi** products, including compliance with all laws, regulations and safety requirements or standards, regardless of any support or applications information provided by **onsemi**. "Typical" parameters which may be provided in **onsemi** data sheets and/or specifications can and do vary in different applications and actual performance may vary over time. All operating parameters, including "Typicals" must be validated for each customer application by customer's technical experts. **onsemi** does not convey any license under any of its intellectual property rights nor the rights of others. **onsemi** products are not designed, intended, or authorized for use as a critical component in life support systems or any FDA Class 3 medical devices or medical devices with a same or similar classification in a foreign jurisdiction or any devices intended for implantation in the human body. Should Buyer purchase or use **onsemi** products for any such unintended or unauthorized application, Buyer shall indemnify and hold **onsemi** and its officers, employees, subsidiaries, affiliates, and distributors harmless against all claims, costs, damages, and expenses, and reasonable attorney fees arising out of, directly or indirectly, any claim of personal injury or death associated with such unintended or unauthorized use, even if such claim alleges that **onsemi** was negligent regarding the design or manufacture of the part. **onsemi** is an Equal Opportunity/Affirmative Action Employer. This literature is subject to all applicable copyright laws and is not for resale in any manner.

PUBLICATION ORDERING INFORMATION

LITERATURE FULFILLMENT:

Email Requests to: orderlit@onsemi.com

onsemi Website: www.onsemi.com

TECHNICAL SUPPORT

North American Technical Support:

Voice Mail: 1 800-282-9855 Toll Free USA/Canada

Phone: 011 421 33 790 2910

Europe, Middle East and Africa Technical Support:

Phone: 00421 33 790 2910

For additional information, please contact your local Sales Representative