

# DATA SHEET

## **TDA8547TS**

**2 × 0.7 W BTL audio amplifier with  
output channel switching**

Product specification  
Supersedes data of 1997 Oct 14  
File under Integrated Circuits, IC01

1998 Apr 01

## 2 × 0.7 W BTL audio amplifier with output channel switching

## TDA8547TS

### FEATURES

- Selection between output channels
- Flexibility in use
- Few external components
- Low saturation voltage of output stage
- Gain can be fixed with external resistors
- Standby mode controlled by CMOS compatible levels
- Low standby current
- No switch-on/switch-off plops
- High supply voltage ripple rejection
- Protected against electrostatic discharge
- Outputs short-circuit safe to ground,  $V_{CC}$  and across the load
- Thermally protected.

### APPLICATIONS

- Telecommunication equipment
- Portable consumer products
- Personal computers
- Motor-driver (servo).

### QUICK REFERENCE DATA

SYMBOL	PARAMETER	CONDITIONS	MIN.	TYP.	MAX.	UNIT
$V_{CC}$	supply voltage		2.2	5	18	V
$I_q$	quiescent current	$V_{CC} = 5\text{ V}$ ; 2 channels	–	15	22	mA
		$V_{CC} = 5\text{ V}$ ; 1 channel	–	8	12	mA
$I_{stb}$	standby current		–	–	10	$\mu\text{A}$
$P_o$	output power two channels	THD = 10%; $R_L = 8\ \Omega$ ; $V_{CC} = 3.3\text{ V}$	0.5	0.6	–	W
		THD = 10%; $R_L = 16\ \Omega$ ; $V_{CC} = 5\text{ V}$	0.6	0.7	–	W
	one channel	THD = 10%; $R_L = 8\ \Omega$ ; $V_{CC} = 5\text{ V}$	1	1.2	–	W
		THD = 10%; $R_L = 4\ \Omega$ ; $V_{CC} = 3.3\text{ V}$	1	1.2	–	W
THD	total harmonic distortion	$P_o = 0.4\text{ W}$	–	0.15	–	%
SVRR	supply voltage ripple rejection		50	–	–	dB

### ORDERING INFORMATION

TYPE NUMBER	PACKAGE		
	NAME	DESCRIPTION	VERSION
TDA8547TS	SSOP20	plastic shrink small outline package; 20 leads; body width 4.4 mm	SOT266-1

2 × 0.7 W BTL audio amplifier with output channel switching

TDA8547TS

BLOCK DIAGRAM

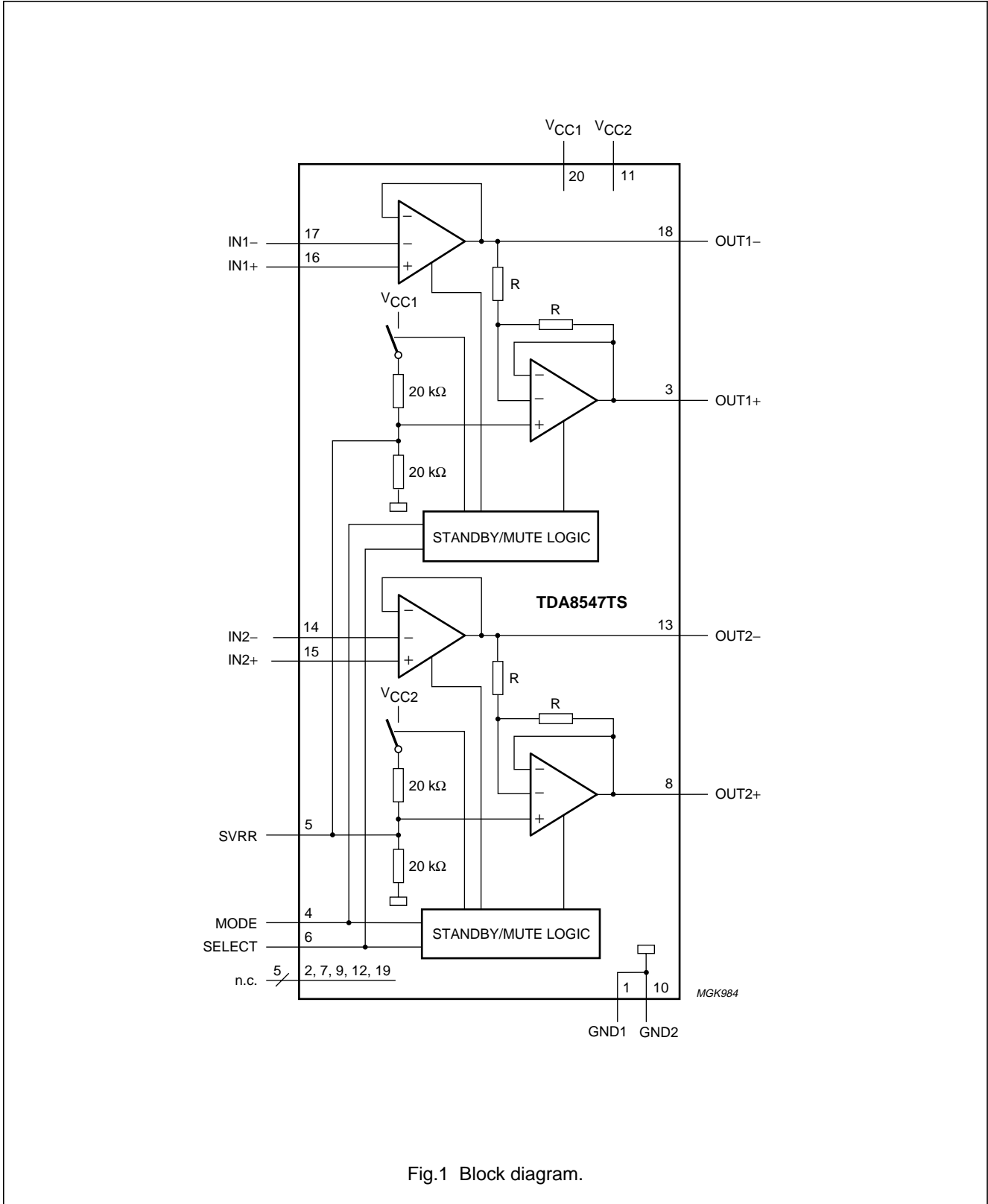

Fig.1 Block diagram.

## 2 × 0.7 W BTL audio amplifier with output channel switching

# TDA8547TS

### PINNING

SYMBOL	PIN	DESCRIPTION
GND1	1	ground, channel 1
n.c.	2	not connected
OUT1+	3	positive loudspeaker terminal, channel 1
MODE	4	operating mode select (standby, mute, operating)
SVRR	5	half supply voltage, decoupling ripple rejection
SELECT	6	input for selection of operating channel
n.c.	7	not connected
OUT2+	8	positive loudspeaker terminal, channel 2
n.c.	9	not connected
GND2	10	ground, channel 2
V <sub>CC2</sub>	11	supply voltage, channel 2
n.c.	12	not connected
OUT2-	13	negative loudspeaker terminal, channel 2
IN2-	14	negative input, channel 2
IN2+	15	positive input, channel 2
IN1+	16	positive input, channel 1
IN1-	17	negative input, channel 1
OUT1-	18	negative loudspeaker terminal, channel 1
n.c.	19	not connected
V <sub>CC1</sub>	20	supply voltage, channel 1

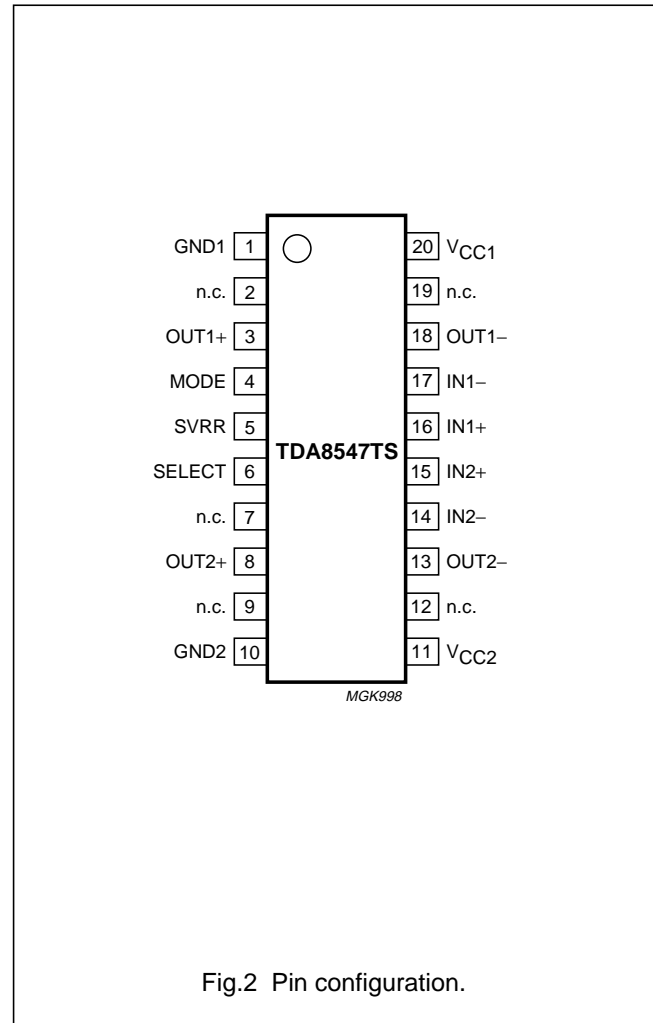

Fig.2 Pin configuration.

### FUNCTIONAL DESCRIPTION

The TDA8547TS is a 2 × 0.7 W BTL audio power amplifier capable of delivering 2 × 0.7 W output power to a 16 Ω load at THD = 10% using a 5 V power supply. Using the MODE pin the device can be switched to standby and mute condition. The device is protected by an internal thermal shutdown protection mechanism. The gain can be set within a range from 6 to 30 dB by external feedback resistors.

#### Power amplifier

The power amplifier is a Bridge-Tied Load (BTL) amplifier with a complementary PNP-NPN output stage. The voltage loss on the positive supply line is the saturation voltage of a PNP power transistor, on the negative side the saturation voltage of a NPN power

transistor. The total voltage loss is <1 V and with a 5 V supply voltage and a 16 Ω loudspeaker an output power of 0.7 W can be delivered, when two channels are operating. If only one channel is operating then an output power of 1.2 W can be delivered (5 V, 8 Ω).

#### MODE pin

The whole device (both channels) is in the standby mode (with a very low current consumption) if the voltage at the MODE pin is  $>(V_{CC} - 0.5 \text{ V})$ , or if this pin is floating. At a MODE voltage level of less than 0.5 V the amplifier is fully operational. In the range between 1.5 V and  $V_{CC} - 1.5 \text{ V}$  the amplifier is in mute condition. The mute condition is useful to suppress plop noise at the output caused by charging of the input capacitor.

## 2 × 0.7 W BTL audio amplifier with output channel switching

TDA8547TS

### SELECT pin

If the voltage at the SELECT pin is in the range between 1.5 V and  $V_{CC} - 1.5$  V, or if it is kept floating, then both channels can be operational. If the SELECT pin is set to a LOW voltage or grounded, then only channel 2 can operate and the power amplifier of channel 1 will be in the standby mode. In this case only the loudspeaker at channel 2 can operate and the loudspeaker at channel 1 will be switched off. If the SELECT pin is set to a HIGH level or connected to  $V_{CC}$ , then only channel 1 can operate and the power amplifier of channel 2 will be in the standby mode. In this case only the loudspeaker at channel 1 can operate and the loudspeaker at channel 2 will be switched off. Setting the SELECT pin to a LOW or

a HIGH voltage results in a reduction of quiescent current consumption by a factor of approximately 2.

Switching with the SELECT pin during operating is not plop-free, because the input capacitor of the channel which is coming out of standby needs to be charged first. For plop-free channel selecting the device has first to be set in mute condition with the MODE pin (between 1.5 V and  $V_{CC} - 1.5$  V), then set the SELECT pin to the new level, after a delay set the MODE pin to a LOW level. The delay needed depends on the values of the input capacitor and the feedback resistors. Time needed is approx.  $10 \times C1 \times (R1 + R2)$ , so approximately 0.6 s. for the values in Fig.4.

**Table 1** Control pins MODE and SELECT versus status of output channels

Voltage levels at control pins at  $V_P = 5$  V; for other supply voltages see Figs. 14 and 15.

CONTROL PIN		STATUS OF OUTPUT CHANNEL		TYP. $I_q$ (mA)
MODE	SELECT	CHANNEL 1	CHANNEL 2	
HIGH <sup>(1)</sup> /NC <sup>(2)</sup>	X <sup>(3)</sup>	standby	standby	0
HVP <sup>(4)</sup>	HVP <sup>(4)</sup> /NC <sup>(2)</sup>	mute	mute	15
LOW <sup>(5)</sup>	HVP <sup>(4)</sup> /NC <sup>(2)</sup>	on	on	15
HVP <sup>(4)</sup> /LOW <sup>(5)</sup>	HIGH <sup>(1)</sup>	mute/on	standby	8
HVP <sup>(4)</sup> /LOW <sup>(5)</sup>	HVP <sup>(4)</sup> /NC <sup>(2)</sup>	mute/on	mute/on	15
HVP <sup>(4)</sup> /LOW <sup>(5)</sup>	LOW <sup>(5)</sup>	standby	mute/on	8

### Notes

1. HIGH =  $V_{pin} > V_{CC} - 0.5$  V.
2. NC = not connected or floating.
3. X = don't care.
4. HVP =  $1.5$  V <  $V_{pin} < V_{CC} - 1.5$  V.
5. LOW =  $V_{pin} < 0.5$  V.

### LIMITING VALUES

In accordance with the Absolute Maximum Rating System (IEC 134).

SYMBOL	PARAMETER	CONDITIONS	MIN.	MAX.	UNIT
$V_{CC}$	supply voltage	operating	-0.3	+18	V
$V_I$	input voltage		-0.3	$V_{CC} + 0.3$	V
$I_{ORM}$	repetitive peak output current		-	1	A
$T_{stg}$	storage temperature		-55	+150	°C
$T_{amb}$	operating ambient temperature		-40	+85	°C
$V_{Psc}$	AC and DC short-circuit safe voltage		-	10	V
$P_{tot}$	power dissipation		-	1.1	W

**2 × 0.7 W BTL audio amplifier with output channel switching**

**TDA8547TS**

**QUALITY SPECIFICATION**

In accordance with "SNW-FQ-611-E".

**THERMAL CHARACTERISTICS**

SYMBOL	PARAMETER	CONDITIONS	VALUE	UNIT
$R_{th(j-a)}$	thermal resistance from junction to ambient	in free air	110	K/W

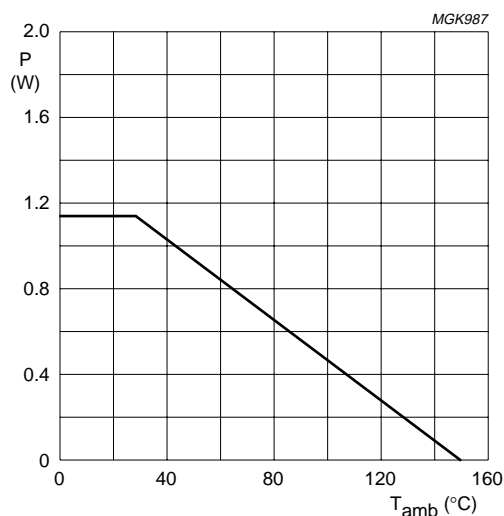

Fig.3 Power derating curve.

**Table 2** Maximum ambient temperature at different conditions

$V_{CC}$ (V)	$R_L$ ( $\Omega$ )	APPLICATION	$P_o$ (W) <sup>(1)</sup>	CONTINUOUS SINE WAVE DRIVEN	
				$P_{max}$ (W)	$T_{amb(max)}$ ( $^{\circ}C$ )
3.3	4	1 channel	1.2	0.58	86
3.3	4	2 channels	2 × 1.2	1.12	27
3.3	8	1 channels	0.6	0.3	117
3.3	8	2 channels	2 × 0.6	0.60	84
5	8	1 channel	1.2	0.67	76
5	8	2 channels	2 × 1.2	1.33	–
5	16	1 channel	0.7	0.35	112
5	16	2 channels	2 × 0.7	0.70	73

**Note**

1. At THD = 10%.

## 2 × 0.7 W BTL audio amplifier with output channel switching

TDA8547TS

### DC CHARACTERISTICS

$V_{CC} = 5\text{ V}$ ;  $T_{amb} = 25\text{ °C}$ ;  $R_L = 8\ \Omega$ ;  $V_{MODE} = 0\text{ V}$ ; gain = 20 dB; measured in BTL application circuit Fig.4; unless otherwise specified.

SYMBOL	PARAMETER	CONDITIONS	MIN.	TYP.	MAX.	UNIT
$V_{CC}$	supply voltage	operating	2.2	5	18	V
$I_q$	quiescent current	BTL 2 channels; note 1	–	15	22	mA
		BTL 1 channel; note 1	–	8	12	mA
$I_{stb}$	standby current	$V_{MODE} = V_{CC}$	–	–	10	$\mu\text{A}$
$V_O$	DC output voltage	note 2	–	2.2	–	V
$ V_{OUT+} - V_{OUT-} $	differential output voltage offset		–	–	50	mV
$I_{IN+}, I_{IN-}$	input bias current		–	–	500	nA
$V_{MODE}$	input voltage MODE pin	operating	0	–	0.5	V
		mute	1.5	–	$V_{CC} - 1.5$	V
		standby	$V_{CC} - 0.5$	–	$V_{CC}$	V
$I_{MODE}$	input current MODE pin	$0\text{ V} < V_{MODE} < V_{CC}$	–	–	20	$\mu\text{A}$
$V_{SELECT}$	input voltage SELECT pin	channel 1 = standby; channel 2 = on	0	–	1	V
		channel 1 = on; channel 2 = standby	$V_{CC} - 1$	–	$V_{CC}$	V
$I_{SELECT}$	input current SELECT pin	$V_{SELECT} = 0\text{ V}$	–	–	100	$\mu\text{A}$

### Notes

1. Measured with  $R_L = \infty$ . With a load connected at the outputs the quiescent current will increase, the maximum of this increase being equal to the DC output offset voltage divided by  $R_L$ .
2. The DC output voltage with respect to ground is approximately  $0.5V_{CC}$ .

## 2 × 0.7 W BTL audio amplifier with output channel switching

TDA8547TS

### AC CHARACTERISTICS

$V_{CC} = 5\text{ V}$ ;  $T_{amb} = 25\text{ °C}$ ;  $R_L = 8\text{ }\Omega$ ;  $f = 1\text{ kHz}$ ;  $V_{MODE} = 0\text{ V}$ ; gain = 20 dB; measured in BTL application circuit Fig.4; unless otherwise specified.

SYMBOL	PARAMETER	CONDITIONS	MIN.	TYP.	MAX.	UNIT
$P_o$	output power, one channel	THD = 10%	1	1.2	–	W
		THD = 0.5%	0.6	0.9	–	W
THD	total harmonic distortion	$P_o = 0.4\text{ W}$	–	0.15	0.3	%
$G_v$	closed loop voltage gain	note 1	6	–	30	dB
$Z_i$	differential input impedance		–	100	–	k $\Omega$
$V_{no}$	noise output voltage	note 2	–	–	100	$\mu\text{V}$
SVRR	supply voltage ripple rejection	note 3	50	–	–	dB
		note 4	40	–	–	dB
$V_o$	output voltage	note 5	–	–	200	$\mu\text{V}$
$\alpha_{cs}$	channel separation	$V_{SELECT} = 0.5V_{CC}$ ; note 6	40	–	–	dB

### Notes

- Gain of the amplifier is  $2 \times \frac{R_2}{R_1}$  in BTL application circuit Fig.4.
- The noise output voltage is measured at the output in a frequency range from 20 Hz to 20 kHz (unweighted), with a source impedance of  $R_S = 0\text{ }\Omega$  at the input.
- Supply voltage ripple rejection is measured at the output, with a source impedance of  $R_S = 0\text{ }\Omega$  at the input. The ripple voltage is a sine wave with a frequency of 1 kHz and an amplitude of 100 mV (RMS), which is applied to the positive supply rail.
- Supply voltage ripple rejection is measured at the output, with a source impedance of  $R_S = 0\text{ }\Omega$  at the input. The ripple voltage is a sine wave with a frequency between 100 Hz and 20 kHz and an amplitude of 100 mV (RMS), which is applied to the positive supply rail.
- Output voltage in mute position is measured with a 1 V (RMS) input voltage in a bandwidth of 20 Hz to 20 kHz, so including noise.
- Channel separation is measured at the output with a source impedance of  $R_S = 0\text{ }\Omega$  at the input and a frequency of 1 kHz. The output power in the operating channel is set to 0.5 W.



## 2 × 0.7 W BTL audio amplifier with output channel switching

TDA8547TS

### TEST AND APPLICATION INFORMATION

#### Test conditions

Because the application can be either Bridge-Tied Load (BTL) or Single-Ended (SE), the curves of each application are shown separately.

The thermal resistance = 110 K/W for the SSOP20; the maximum sine wave power dissipation for  $T_{amb} = 25\text{ °C}$

$$\text{is: } \frac{150 - 25}{110} = 1.14\text{ W}$$

For  $T_{amb} = 60\text{ °C}$  the maximum total power dissipation is:

$$\frac{150 - 60}{110} = 0.82\text{ W}$$

#### Thermal Design Considerations

The 'measured' thermal resistance of the IC package is highly dependent on the configuration and size of the application board. Data may not be comparable between different Semiconductor manufacturers because the application boards and test methods are not (yet) standardized. Also, the thermal performance of packages for a specific application may be different than presented here, because the configuration of the application boards (copper area!) may be different. Philips Semiconductors uses FR-4 type application boards with 1 oz copper traces with solder coating.

The SSOP package has improved thermal conductivity which reduces the thermal resistance. Using a practical PCB layout (see Fig.24) with wider copper tracks to the corner pins and just under the IC, the thermal resistance from junction to ambient can be reduced to about 80 K/W. For  $T_{amb} = 60\text{ °C}$  the maximum total power dissipation at

$$\text{this PCB layout is: } \frac{150 - 60}{80} = 1.12\text{ W}$$

Please note that this two channel IC is mentioned for application with only one channel active. For that reason the curves for worst case power dissipation are given for the condition of only one of the both channels driven with a 1 kHz sine wave signal.

#### BTL application

$T_{amb} = 25\text{ °C}$  if not specially mentioned,  $V_{CC} = 5\text{ V}$ ,  $f = 1\text{ kHz}$ ,  $R_L = 8\ \Omega$ ,  $G_v = 20\text{ dB}$ , audio band-pass 22 Hz to 22 kHz.

The BTL application circuit is illustrated in Fig.4.

The quiescent current has been measured without any load impedance and both channels driven. When one channel is active the quiescent current will be halved. The total harmonic distortion as a function of frequency was measured using a low-pass filter of 80 kHz. The value of capacitor C3 influences the behaviour of the SVRR at low frequencies: increasing the value of C3 increases the performance of the SVRR. The figure of the MODE voltage ( $V_{MODE}$ ) as a function of the supply voltage shows three areas; operating, mute and standby. It shows, that the DC-switching levels of the mute and standby respectively depend on the supply voltage level. The figure of the SELECT voltage ( $V_{SELECT}$ ) as a function of the supply voltage shows the voltage levels for switching the channels in the active, mute or standby mode.

#### SE application

$T_{amb} = 25\text{ °C}$  if not specially mentioned,  $V_{CC} = 7.5\text{ V}$ ,  $f = 1\text{ kHz}$ ,  $R_L = 4\ \Omega$ ,  $G_v = 20\text{ dB}$ , audio band-pass 22 Hz to 22 kHz.

The SE application circuit is illustrated in Fig.16.

Increasing the value of electrolytic capacitor C3 will result in a better channel separation. Because the positive output is not designed for high output current ( $2 \times I_o$ ) at low load impedance ( $\leq 16\ \Omega$ ), the SE application with output capacitors connected to ground is advised. The capacitor value of C6/C7 in combination with the load impedance determines the low frequency behaviour. The THD as a function of frequency was measured using a low-pass filter of 80 kHz. The value of capacitor C3 influences the behaviour of the SVRR at low frequencies: increasing the value of C3 increases the performance of the SVRR.

#### General remark

The frequency characteristic can be adapted by connecting a small capacitor across the feedback resistor. To improve the immunity to HF radiation in radio circuit applications, a small capacitor can be connected in parallel with the feedback resistor (56 k $\Omega$ ); this creates a low-pass filter.

2 × 0.7 W BTL audio amplifier with output channel switching

TDA8547TS

BTL APPLICATION

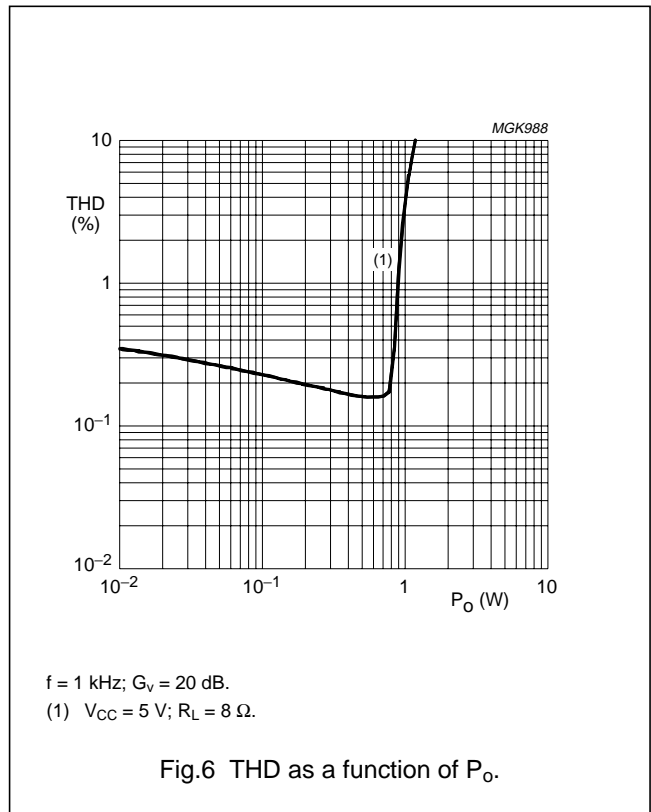
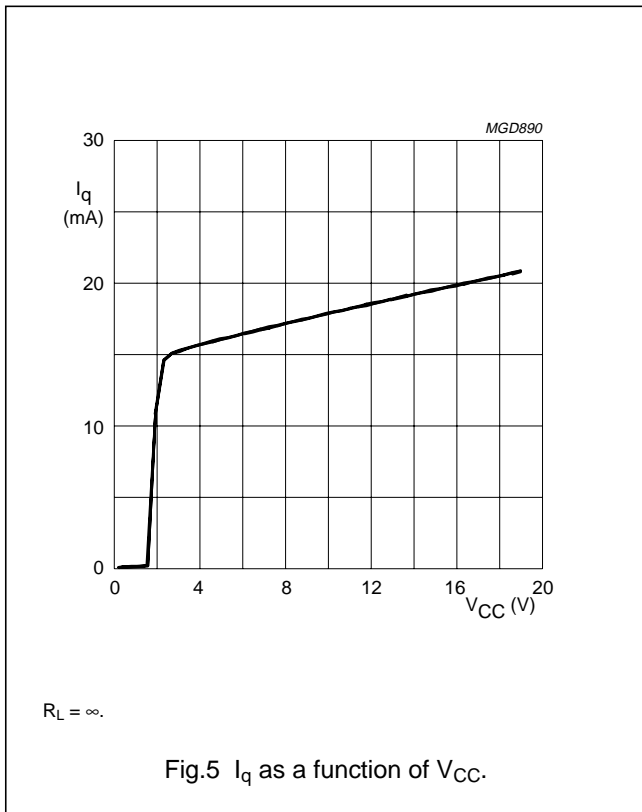
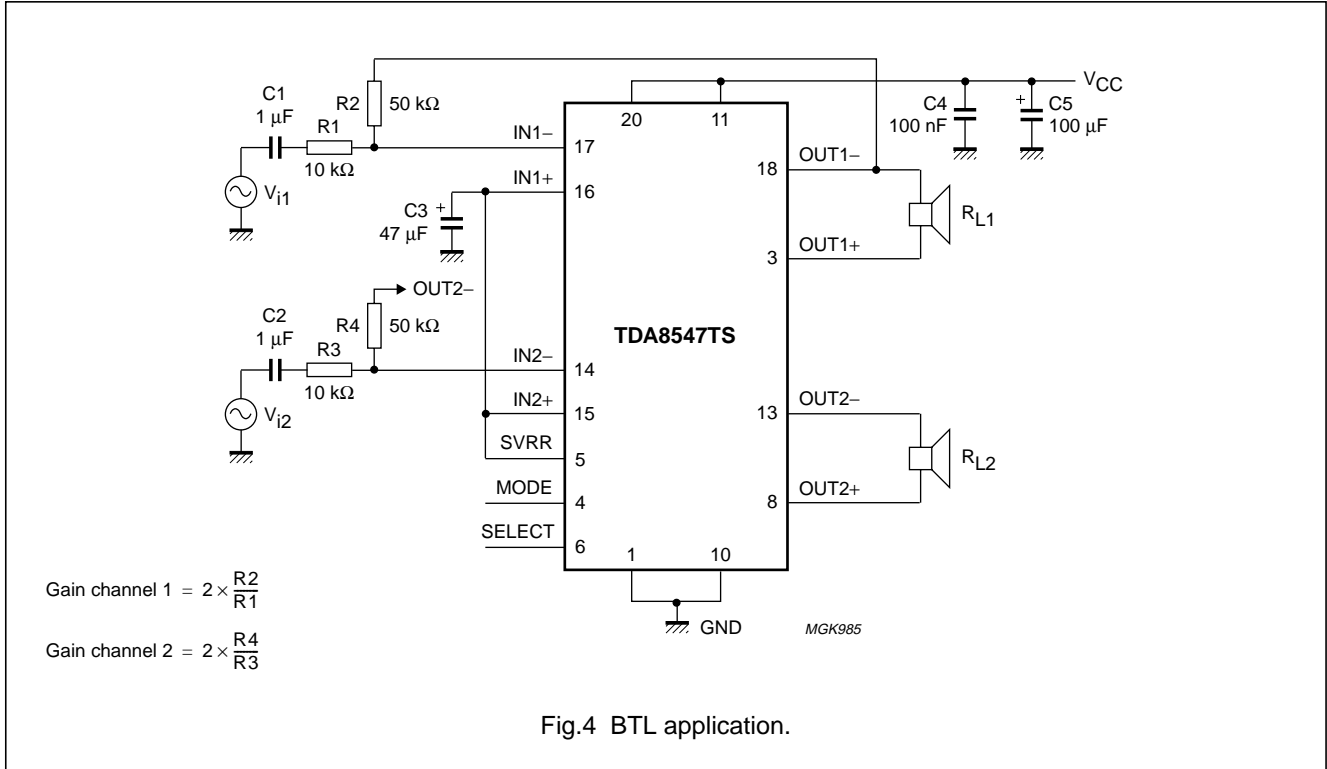

2 × 0.7 W BTL audio amplifier with output channel switching

TDA8547TS

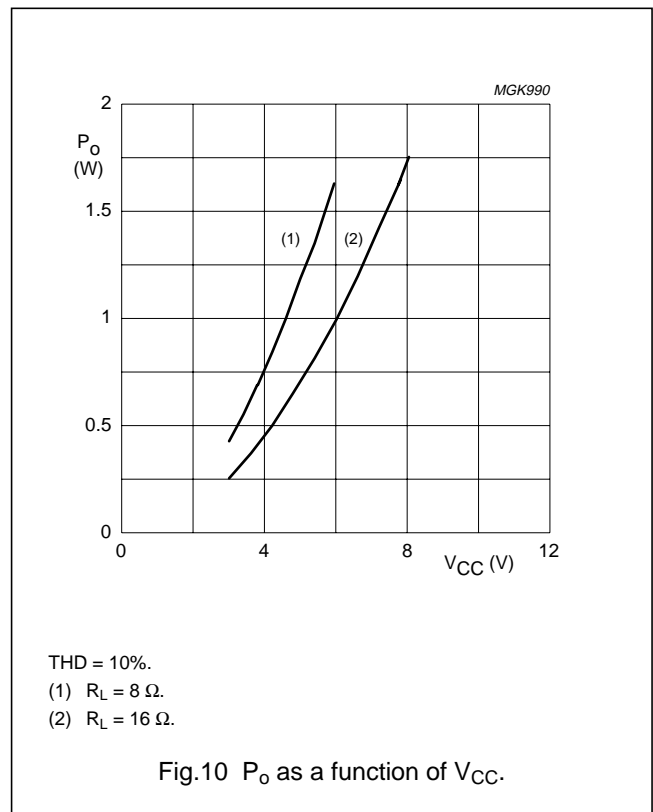
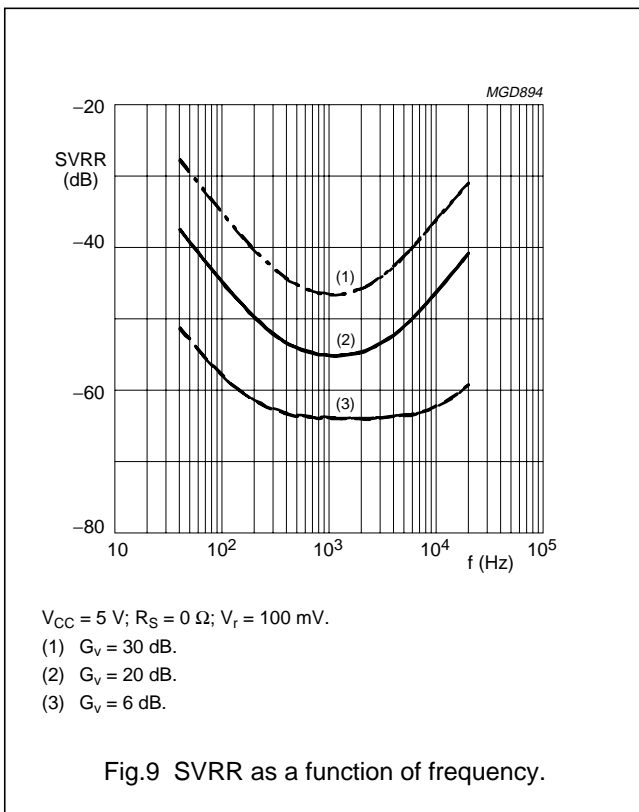
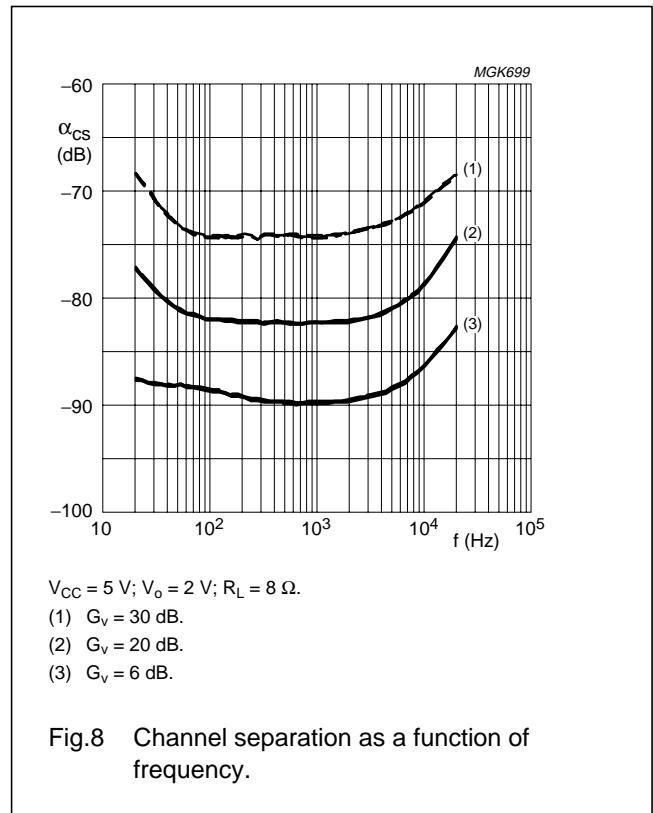
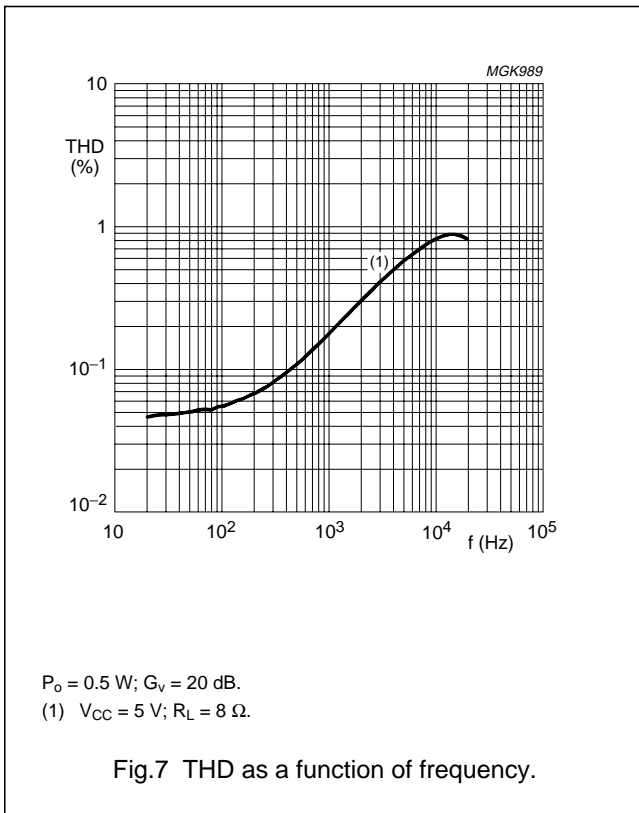

2 × 0.7 W BTL audio amplifier with output channel switching

TDA8547TS

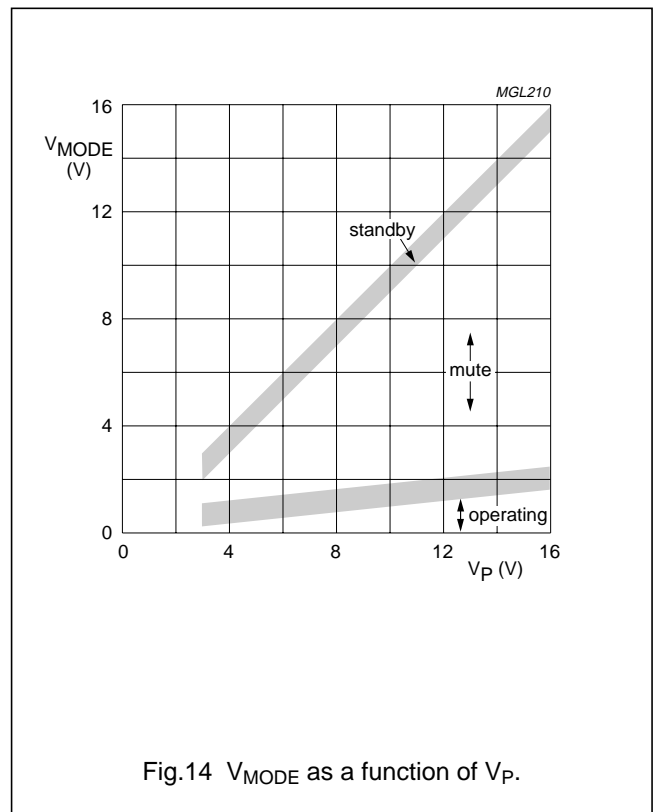
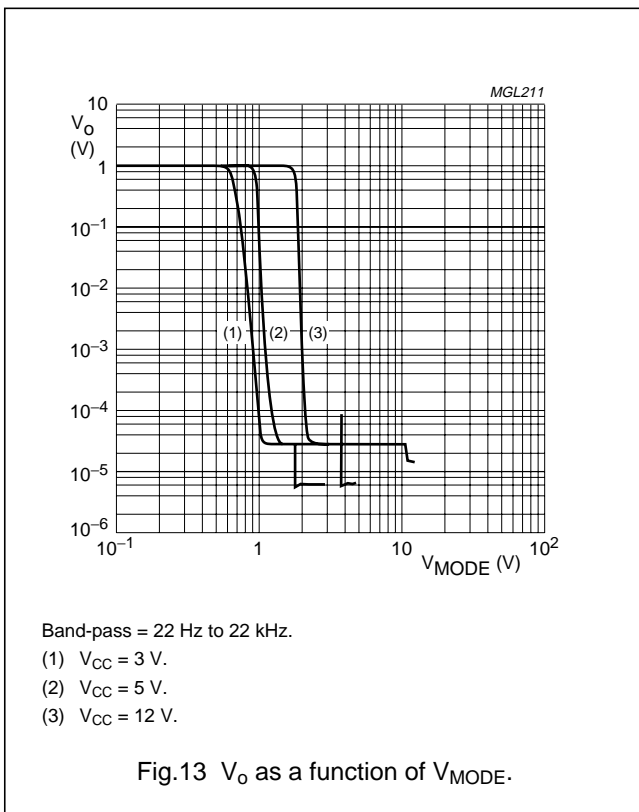
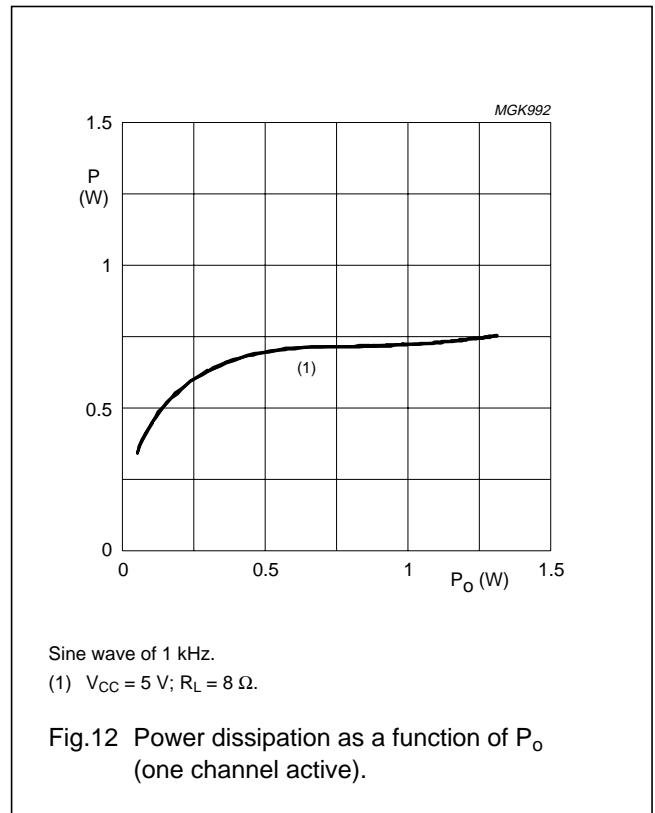
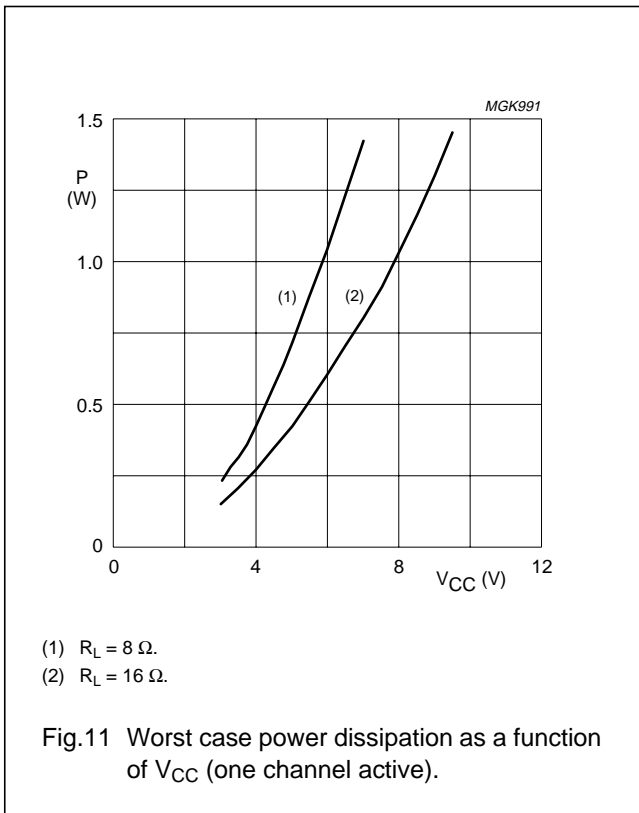

2 × 0.7 W BTL audio amplifier with output channel switching

TDA8547TS

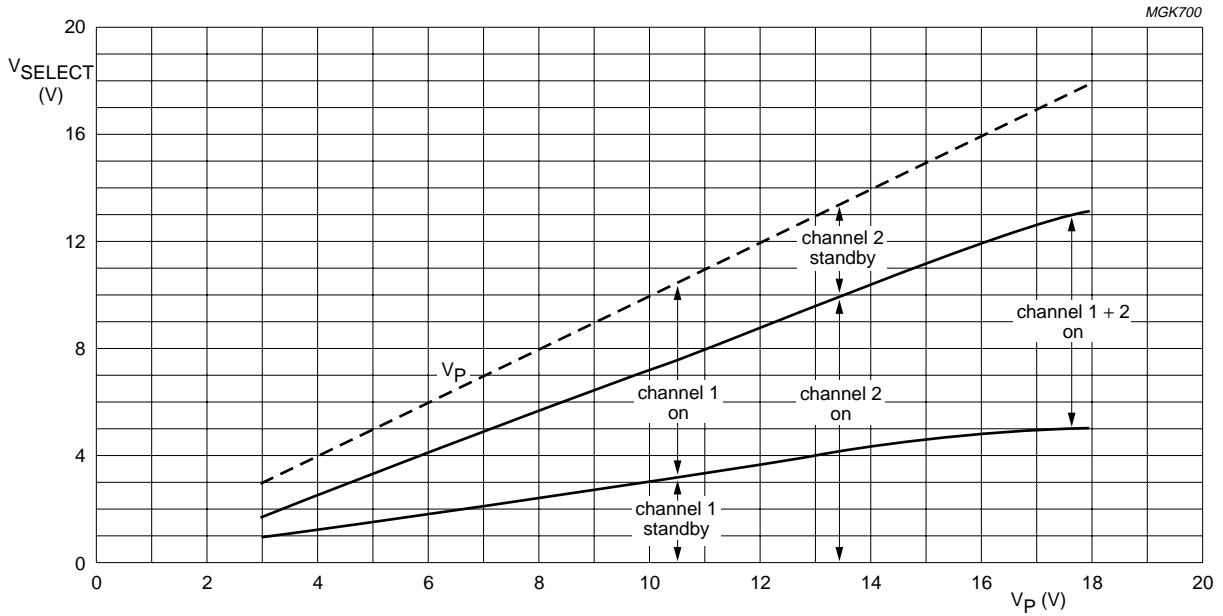

Fig.15  $V_{SELECT}$  as a function of  $V_P$ .

SE APPLICATION

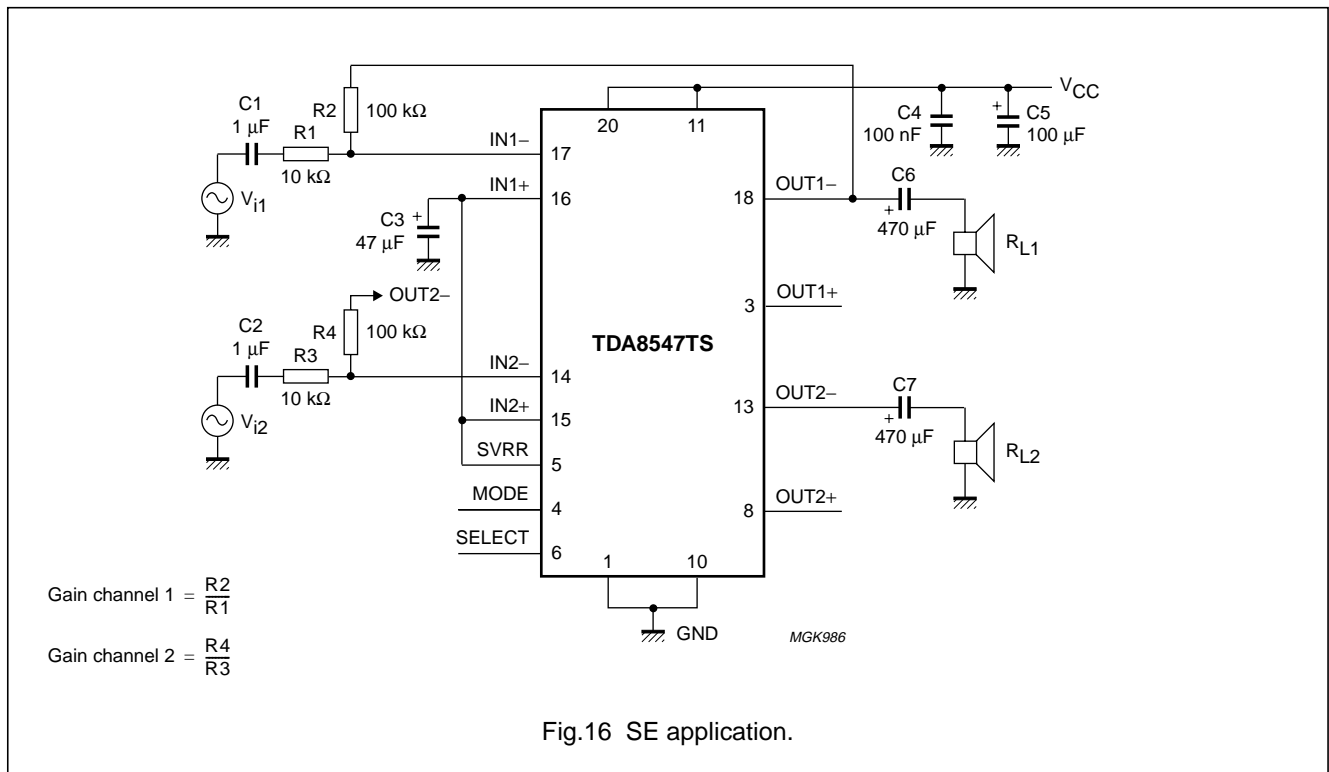
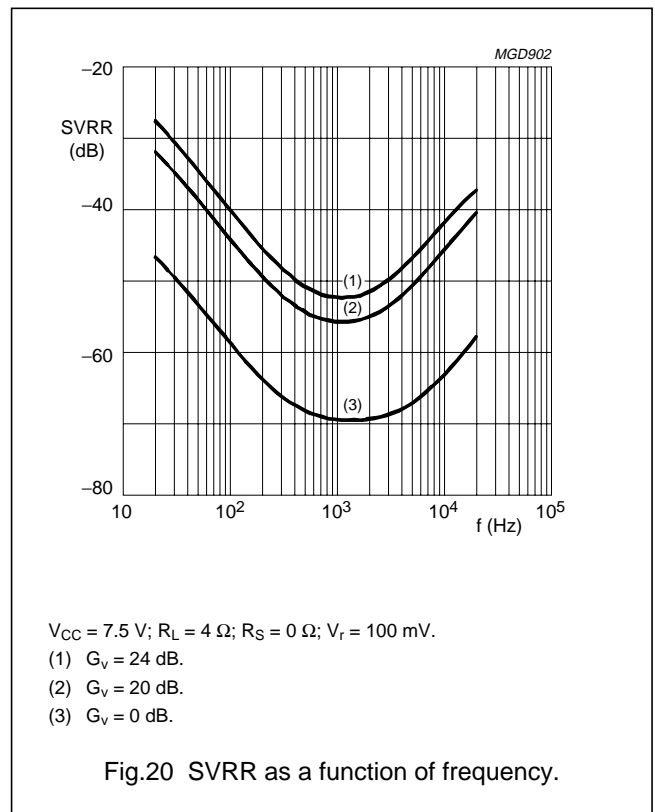
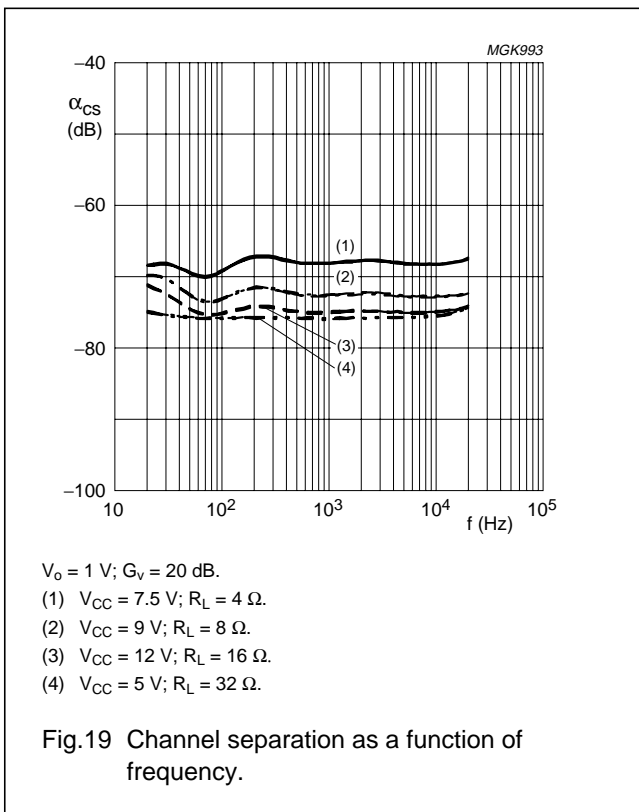
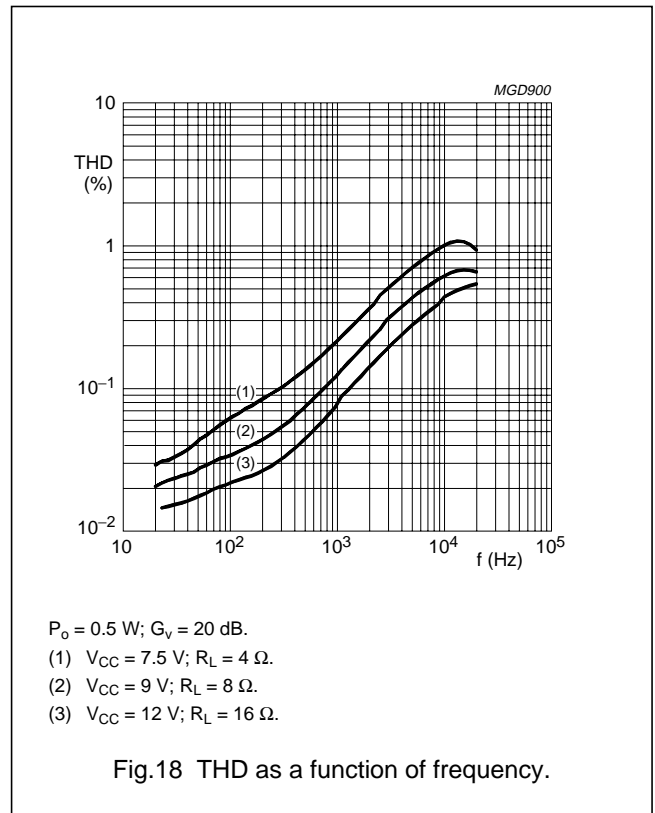
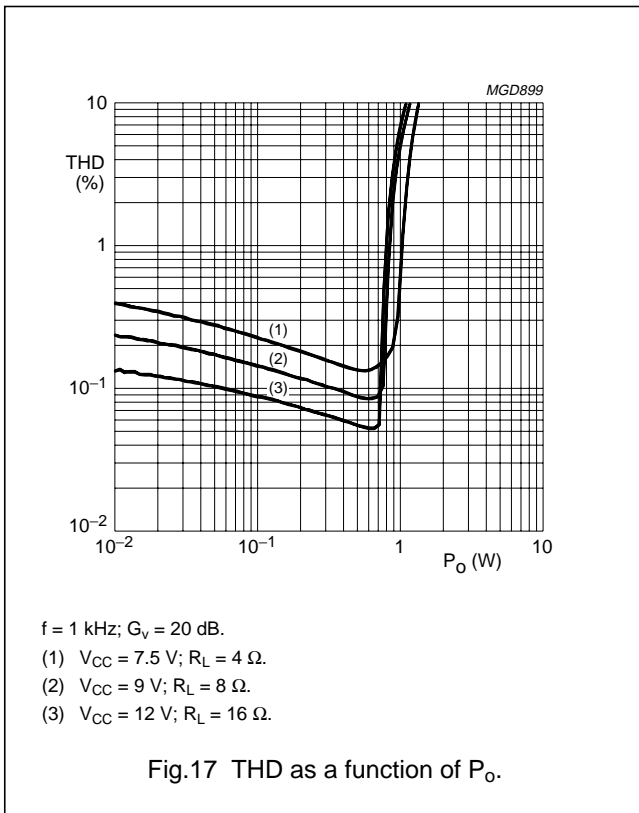

Fig.16 SE application.

2 × 0.7 W BTL audio amplifier with output channel switching

TDA8547TS



2 × 0.7 W BTL audio amplifier with output channel switching

TDA8547TS

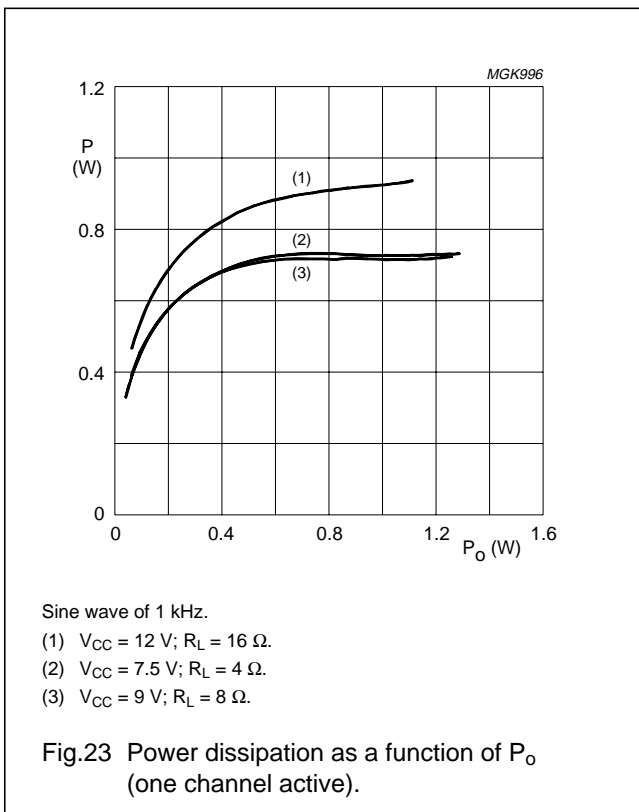
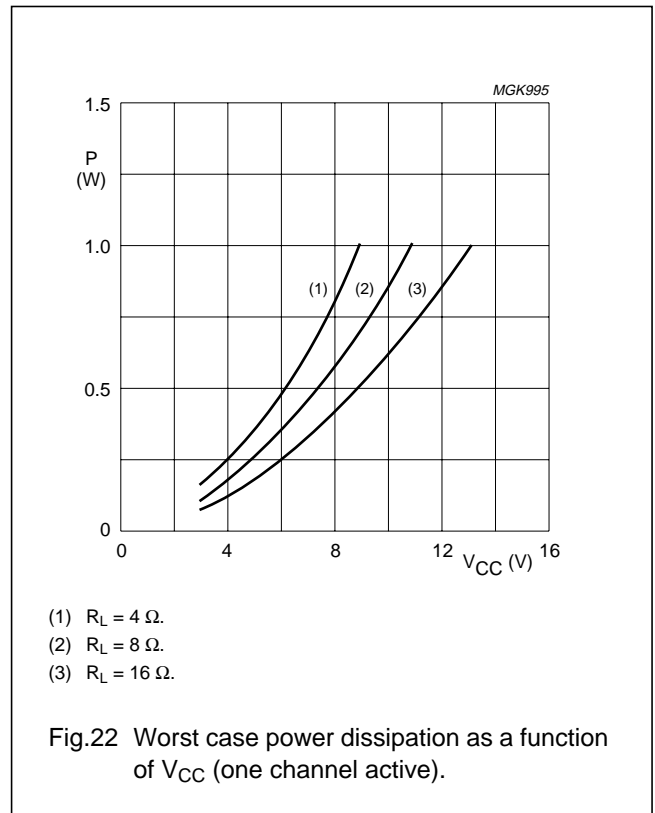
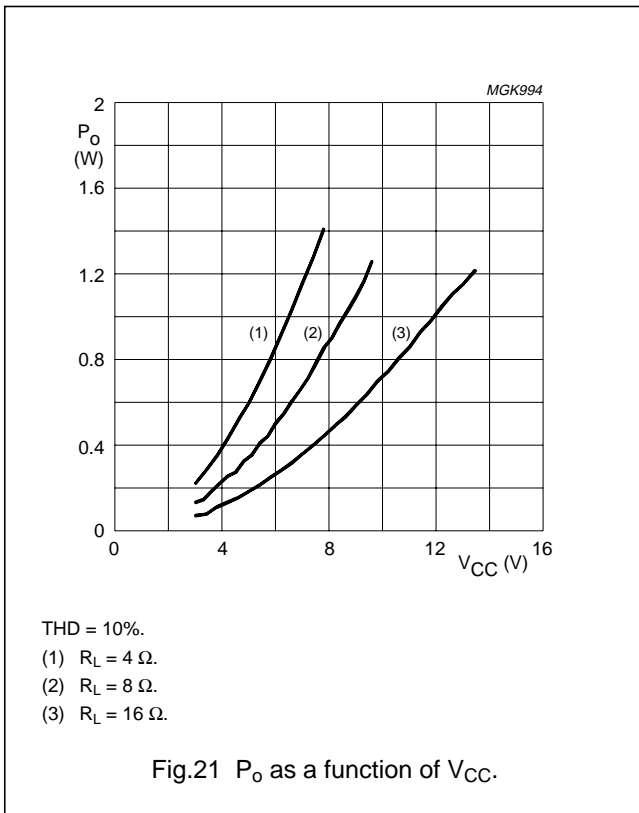

2 × 0.7 W BTL audio amplifier with output channel switching

TDA8547TS

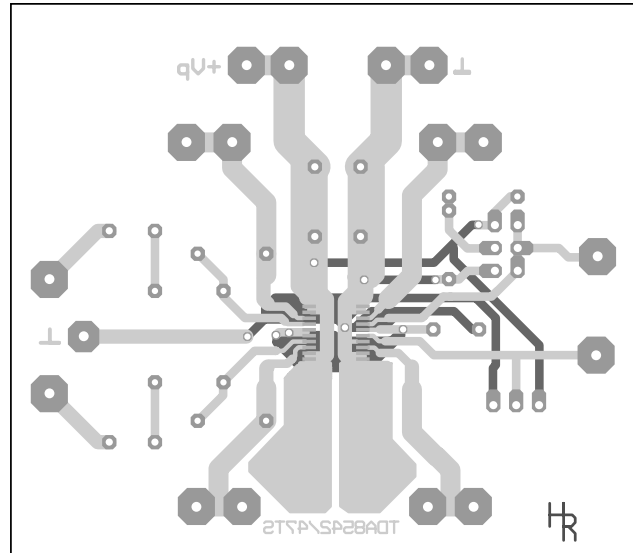

a. Top view copper layout.

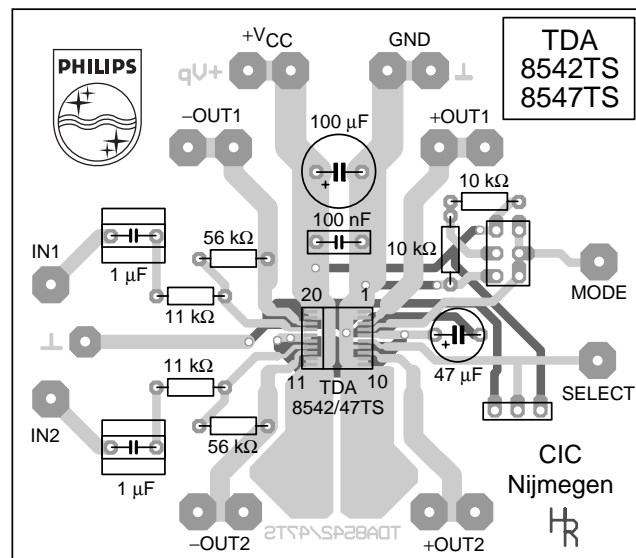

b. Top view components layout.

Fig.24 Printed-circuit board layout (BTL).



2 × 0.7 W BTL audio amplifier with output channel switching

TDA8547TS

PACKAGE OUTLINE

SSOP20: plastic shrink small outline package; 20 leads; body width 4.4 mm

SOT266-1

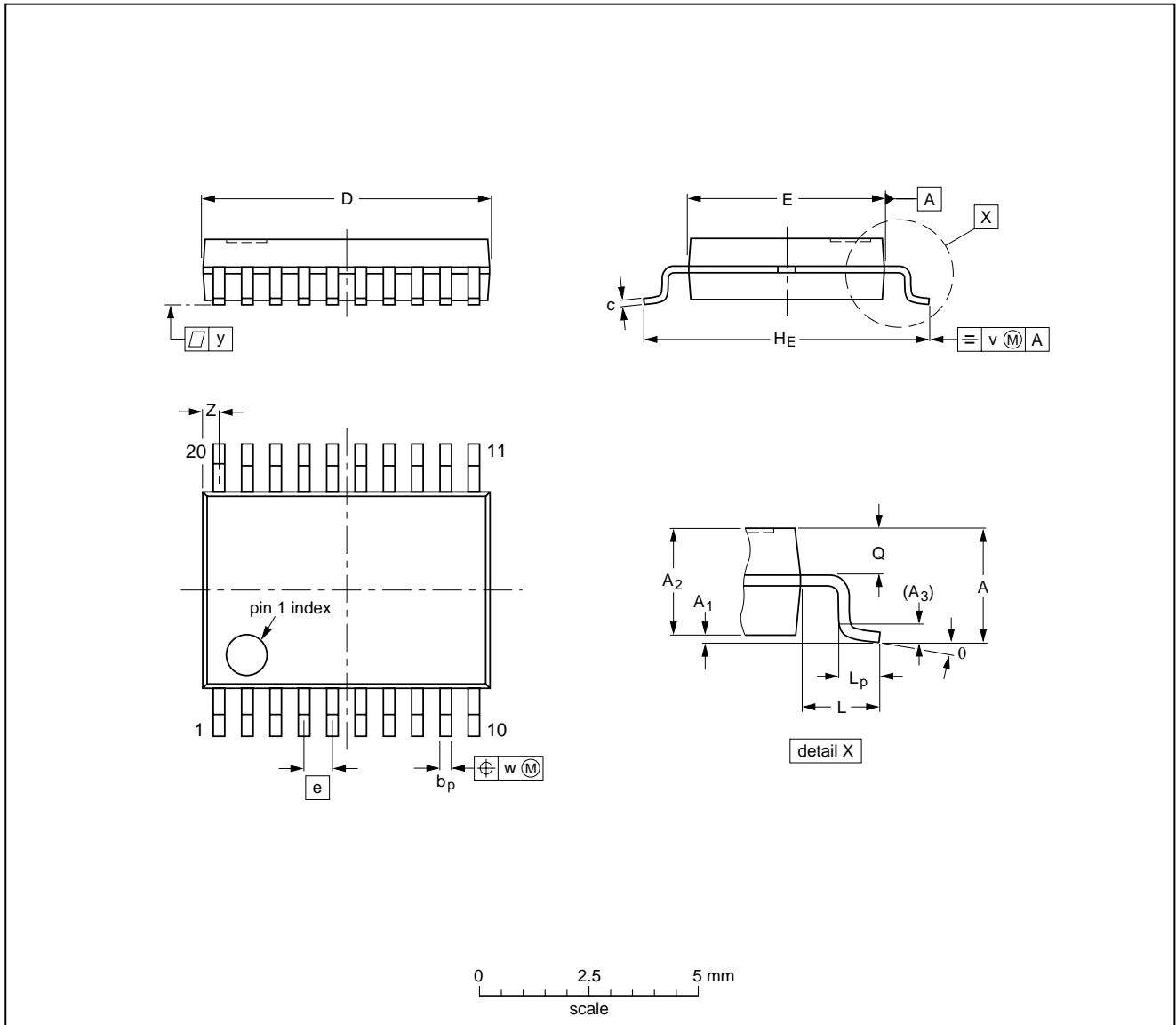

DIMENSIONS (mm are the original dimensions)

UNIT	A max.	A <sub>1</sub>	A <sub>2</sub>	A <sub>3</sub>	b <sub>p</sub>	c	D <sup>(1)</sup>	E <sup>(1)</sup>	e	H <sub>E</sub>	L	L <sub>p</sub>	Q	v	w	y	Z <sup>(1)</sup>	θ
mm	1.5	0.15 0	1.4 1.2	0.25	0.32 0.20	0.20 0.13	6.6 6.4	4.5 4.3	0.65	6.6 6.2	1.0	0.75 0.45	0.65 0.45	0.2	0.13	0.1	0.48 0.18	10° 0°

Note

1. Plastic or metal protrusions of 0.20 mm maximum per side are not included.

OUTLINE VERSION	REFERENCES				EUROPEAN PROJECTION	ISSUE DATE
	IEC	JEDEC	EIAJ			
SOT266-1						90-04-05 95-02-25

## 2 × 0.7 W BTL audio amplifier with output channel switching

TDA8547TS

### SOLDERING

#### Introduction

There is no soldering method that is ideal for all IC packages. Wave soldering is often preferred when through-hole and surface mounted components are mixed on one printed-circuit board. However, wave soldering is not always suitable for surface mounted ICs, or for printed-circuits with high population densities. In these situations reflow soldering is often used.

This text gives a very brief insight to a complex technology. A more in-depth account of soldering ICs can be found in our *"IC Package Databook"* (order code 9398 652 90011).

#### DIP

##### SOLDERING BY DIPPING OR BY WAVE

The maximum permissible temperature of the solder is 260 °C; solder at this temperature must not be in contact with the joint for more than 5 seconds. The total contact time of successive solder waves must not exceed 5 seconds.

The device may be mounted up to the seating plane, but the temperature of the plastic body must not exceed the specified maximum storage temperature ( $T_{stg\ max}$ ). If the printed-circuit board has been pre-heated, forced cooling may be necessary immediately after soldering to keep the temperature within the permissible limit.

##### REPAIRING SOLDERED JOINTS

Apply a low voltage soldering iron (less than 24 V) to the lead(s) of the package, below the seating plane or not more than 2 mm above it. If the temperature of the soldering iron bit is less than 300 °C it may remain in contact for up to 10 seconds. If the bit temperature is between 300 and 400 °C, contact may be up to 5 seconds.

#### SO

##### REFLOW SOLDERING

Reflow soldering techniques are suitable for all SO packages.

Reflow soldering requires solder paste (a suspension of fine solder particles, flux and binding agent) to be applied to the printed-circuit board by screen printing, stencilling or pressure-syringe dispensing before package placement.

Several techniques exist for reflowing; for example, thermal conduction by heated belt. Dwell times vary between 50 and 300 seconds depending on heating method. Typical reflow temperatures range from 215 to 250 °C.

Preheating is necessary to dry the paste and evaporate the binding agent. Preheating duration: 45 minutes at 45 °C.

##### WAVE SOLDERING

Wave soldering techniques can be used for all SO packages if the following conditions are observed:

- A double-wave (a turbulent wave with high upward pressure followed by a smooth laminar wave) soldering technique should be used.
- The longitudinal axis of the package footprint must be parallel to the solder flow.
- The package footprint must incorporate solder thieves at the downstream end.

During placement and before soldering, the package must be fixed with a droplet of adhesive. The adhesive can be applied by screen printing, pin transfer or syringe dispensing. The package can be soldered after the adhesive is cured.

Maximum permissible solder temperature is 260 °C, and maximum duration of package immersion in solder is 10 seconds, if cooled to less than 150 °C within 6 seconds. Typical dwell time is 4 seconds at 250 °C.

A mildly-activated flux will eliminate the need for removal of corrosive residues in most applications.

##### REPAIRING SOLDERED JOINTS

Fix the component by first soldering two diagonally-opposite end leads. Use only a low voltage soldering iron (less than 24 V) applied to the flat part of the lead. Contact time must be limited to 10 seconds at up to 300 °C. When using a dedicated tool, all other leads can be soldered in one operation within 2 to 5 seconds between 270 and 320 °C.

---

**2 × 0.7 W BTL audio amplifier with  
output channel switching**

---

**TDA8547TS****DEFINITIONS**

<b>Data sheet status</b>	
Objective specification	This data sheet contains target or goal specifications for product development.
Preliminary specification	This data sheet contains preliminary data; supplementary data may be published later.
Product specification	This data sheet contains final product specifications.
<b>Limiting values</b>	
Limiting values given are in accordance with the Absolute Maximum Rating System (IEC 134). Stress above one or more of the limiting values may cause permanent damage to the device. These are stress ratings only and operation of the device at these or at any other conditions above those given in the Characteristics sections of the specification is not implied. Exposure to limiting values for extended periods may affect device reliability.	
<b>Application information</b>	
Where application information is given, it is advisory and does not form part of the specification.	

**LIFE SUPPORT APPLICATIONS**

These products are not designed for use in life support appliances, devices, or systems where malfunction of these products can reasonably be expected to result in personal injury. Philips customers using or selling these products for use in such applications do so at their own risk and agree to fully indemnify Philips for any damages resulting from such improper use or sale.

# Philips Semiconductors – a worldwide company

**Argentina:** see South America

**Australia:** 34 Waterloo Road, NORTH RYDE, NSW 2113,  
Tel. +61 2 9805 4455, Fax. +61 2 9805 4466

**Austria:** Computerstr. 6, A-1101 WIEN, P.O. Box 213, Tel. +43 160 1010,  
Fax. +43 160 101 1210

**Belarus:** Hotel Minsk Business Center, Bld. 3, r. 1211, Volodarski Str. 6,  
220050 MINSK, Tel. +375 172 200 733, Fax. +375 172 200 773

**Belgium:** see The Netherlands

**Brazil:** see South America

**Bulgaria:** Philips Bulgaria Ltd., Energoproject, 15th floor,  
51 James Bourchier Blvd., 1407 SOFIA,  
Tel. +359 2 689 211, Fax. +359 2 689 102

**Canada:** PHILIPS SEMICONDUCTORS/COMPONENTS,  
Tel. +1 800 234 7381

**China/Hong Kong:** 501 Hong Kong Industrial Technology Centre,  
72 Tat Chee Avenue, Kowloon Tong, HONG KONG,  
Tel. +852 2319 7888, Fax. +852 2319 7700

**Colombia:** see South America

**Czech Republic:** see Austria

**Denmark:** Prags Boulevard 80, PB 1919, DK-2300 COPENHAGEN S,  
Tel. +45 32 88 2636, Fax. +45 31 57 0044

**Finland:** Sinikalliontie 3, FIN-02630 ESPOO,  
Tel. +358 9 615800, Fax. +358 9 61580920

**France:** 4 Rue du Port-aux-Vins, BP317, 92156 SURESNES Cedex,  
Tel. +33 1 40 99 6161, Fax. +33 1 40 99 6427

**Germany:** Hammerbrookstraße 69, D-20097 HAMBURG,  
Tel. +49 40 23 53 60, Fax. +49 40 23 536 300

**Greece:** No. 15, 25th March Street, GR 17778 TAVROS/ATHENS,  
Tel. +30 1 4894 339/239, Fax. +30 1 4814 240

**Hungary:** see Austria

**India:** Philips INDIA Ltd, Band Box Building, 2nd floor,  
254-D, Dr. Annie Besant Road, Worli, MUMBAI 400 025,  
Tel. +91 22 493 8541, Fax. +91 22 493 0966

**Indonesia:** see Singapore

**Ireland:** Newstead, Clonskeagh, DUBLIN 14,  
Tel. +353 1 7640 000, Fax. +353 1 7640 200

**Israel:** RAPAC Electronics, 7 Kehilat Saloniki St, PO Box 18053,  
TEL AVIV 61180, Tel. +972 3 645 0444, Fax. +972 3 649 1007

**Italy:** PHILIPS SEMICONDUCTORS, Piazza IV Novembre 3,  
20124 MILANO, Tel. +39 2 6752 2531, Fax. +39 2 6752 2557

**Japan:** Philips Bldg 13-37, Kohnan 2-chome, Minato-ku, TOKYO 108,  
Tel. +81 3 3740 5130, Fax. +81 3 3740 5077

**Korea:** Philips House, 260-199 Itaewon-dong, Yongsan-ku, SEOUL,  
Tel. +82 2 709 1412, Fax. +82 2 709 1415

**Malaysia:** No. 76 Jalan Universiti, 46200 PETALING JAYA, SELANGOR,  
Tel. +60 3 750 5214, Fax. +60 3 757 4880

**Mexico:** 5900 Gateway East, Suite 200, EL PASO, TEXAS 79905,  
Tel. +9-5 800 234 7381

**Middle East:** see Italy

**Netherlands:** Postbus 90050, 5600 PB EINDHOVEN, Bldg. VB,  
Tel. +31 40 27 82785, Fax. +31 40 27 88399

**New Zealand:** 2 Wagener Place, C.P.O. Box 1041, AUCKLAND,  
Tel. +64 9 849 4160, Fax. +64 9 849 7811

**Norway:** Box 1, Manglerud 0612, OSLO,  
Tel. +47 22 74 8000, Fax. +47 22 74 8341

**Philippines:** Philips Semiconductors Philippines Inc.,  
106 Valero St. Salcedo Village, P.O. Box 2108 MCC, MAKATI,  
Metro MANILA, Tel. +63 2 816 6380, Fax. +63 2 817 3474

**Poland:** Ul. Lukiska 10, PL 04-123 WARSZAWA,  
Tel. +48 22 612 2831, Fax. +48 22 612 2327

**Portugal:** see Spain

**Romania:** see Italy

**Russia:** Philips Russia, Ul. Usatcheva 35A, 119048 MOSCOW,  
Tel. +7 095 755 6918, Fax. +7 095 755 6919

**Singapore:** Lorong 1, Toa Payoh, SINGAPORE 1231,  
Tel. +65 350 2538, Fax. +65 251 6500

**Slovakia:** see Austria

**Slovenia:** see Italy

**South Africa:** S.A. PHILIPS Pty Ltd., 195-215 Main Road Martindale,  
2092 JOHANNESBURG, P.O. Box 7430 Johannesburg 2000,  
Tel. +27 11 470 5911, Fax. +27 11 470 5494

**South America:** Rua do Rocio 220, 5th floor, Suite 51,  
04552-903 São Paulo, SÃO PAULO - SP, Brazil,  
Tel. +55 11 821 2333, Fax. +55 11 829 1849

**Spain:** Balmes 22, 08007 BARCELONA,  
Tel. +34 3 301 6312, Fax. +34 3 301 4107

**Sweden:** Kottbygatan 7, Akalla, S-16485 STOCKHOLM,  
Tel. +46 8 632 2000, Fax. +46 8 632 2745

**Switzerland:** Allmendstrasse 140, CH-8027 ZÜRICH,  
Tel. +41 1 488 2686, Fax. +41 1 481 7730

**Taiwan:** Philips Semiconductors, 6F, No. 96, Chien Kuo N. Rd., Sec. 1,  
TAIPEI, Taiwan Tel. +886 2 2134 2865, Fax. +886 2 2134 2874

**Thailand:** PHILIPS ELECTRONICS (THAILAND) Ltd.,  
209/2 Sanpavuth-Bangna Road Prakanong, BANGKOK 10260,  
Tel. +66 2 745 4090, Fax. +66 2 398 0793

**Turkey:** Talatpasa Cad. No. 5, 80640 GÜLTEPE/ISTANBUL,  
Tel. +90 212 279 2770, Fax. +90 212 282 6707

**Ukraine:** PHILIPS UKRAINE, 4 Patrice Lumumba str., Building B, Floor 7,  
252042 KIEV, Tel. +380 44 264 2776, Fax. +380 44 268 0461

**United Kingdom:** Philips Semiconductors Ltd., 276 Bath Road, Hayes,  
MIDDLESEX UB3 5BX, Tel. +44 181 730 5000, Fax. +44 181 754 8421

**United States:** 811 East Arques Avenue, SUNNYVALE, CA 94088-3409,  
Tel. +1 800 234 7381

**Uruguay:** see South America

**Vietnam:** see Singapore

**Yugoslavia:** PHILIPS, Trg N. Pasica 5/v, 11000 BEOGRAD,  
Tel. +381 11 625 344, Fax. +381 11 635 777

**For all other countries apply to:** Philips Semiconductors, Marketing & Sales Communications,  
Building BE-p, P.O. Box 218, 5600 MD EINDHOVEN, The Netherlands, Fax. +31 40 27 24825

**Internet:** <http://www.semiconductors.philips.com>

© Philips Electronics N.V. 1997

SCA55

All rights are reserved. Reproduction in whole or in part is prohibited without the prior written consent of the copyright owner.

The information presented in this document does not form part of any quotation or contract, is believed to be accurate and reliable and may be changed without notice. No liability will be accepted by the publisher for any consequence of its use. Publication thereof does not convey nor imply any license under patent- or other industrial or intellectual property rights.

Printed in The Netherlands

545102/00/02/pp20

Date of release: 1998 Apr 01

Document order number: 9397 750 03347

*Let's make things better.*

**Philips  
Semiconductors**



**PHILIPS**

This datasheet has been download from:

[www.datasheetcatalog.com](http://www.datasheetcatalog.com)

Datasheets for electronics components.