

Power MOSFET Integrated High Efficiency BCM LED Driver Controller for High Power Factor Applications

General Description

The RT8497 integrates a power MOSFET and a Boundary mode controller. It is used for step down converters by well controlling the internal MOSFET and regulating a constant output current.

The RT8497 features a ZCS detector which keeps system operating in BCM and obtaining excellent power efficiency, better EMI performance.

The RT8497 achieves high Power Factor Correction (PFC) and low Total Harmonic Distortion of Current (THDi) by a smart internal line voltage compensation circuit which has minimized system component counts; saved both PCB size and total system cost.

Especially, the RT8497 can use a cheap simple drum core inductor in the system instead of an EE core to obtain high efficiency.

The RT8497 is housed in a SOP-8 package. Thus, the components in the whole LED driver system can be made very compact.

Ordering Information

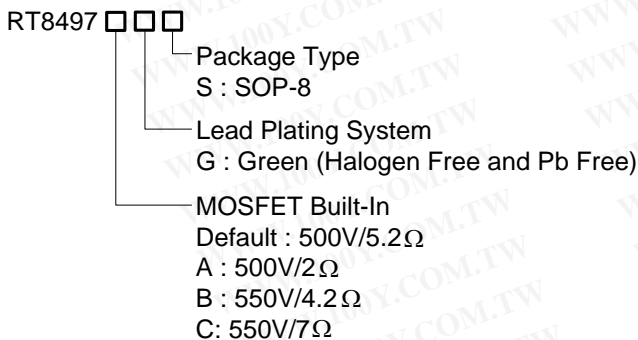

Note :

Richtek products are :

- ▶ RoHS compliant and compatible with the current requirements of IPC/JEDEC J-STD-020.
- ▶ Suitable for use in SnPb or Pb-free soldering processes

Features

- Built-In Power MOSFET
- Support High Power Factor and THDi Consideration Applications
- Programmable Constant LED Current with Highly Precision Current Regulation
- Extremely Low Quiescent Current Consumption and 1μA Shutdown Current
- True Low System BOM Cost and Economical Floating Buck Converter Solution
- Unique Programmable AND Pin for ZVS Setting to Achieve Best Power Efficiency
- Universal Input Voltage Range with Off-Line Topology
- Built-in Over Thermal Protection
- Built-in Over Voltage Protection
- Output LED String Open Protection
- Output LED String Short Protection
- Output LED String Over Current Protection

Applications

- E27, PAR, Light Bar, Offline LED Lights

Pin Configurations

(TOP VIEW)

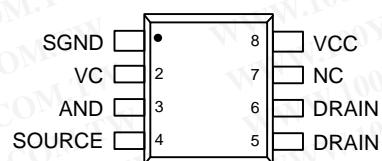

SOP-8

勝特力材料 886-3-5753170
 勝特力电子(上海) 86-21-34970699
 勝特力电子(深圳) 86-755-83298787
 Http://www.100y.com.tw

Marking Information

RT8497GS

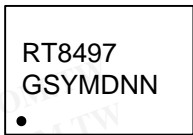

RT8497GS : Product Number
YMDNN : Date Code

RT8497AGS

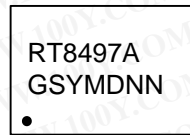

RT8497AGS : Product Number
YMDNN : Date Code

RT8497BGS



RT8497BGS : Product Number
YMDNN : Date Code

RT8497CGS



RT8497CGS : Product Number
YMDNN : Date Code

Functional Pin Description

| Pin No. | Pin Name | Pin Function |
|---------|----------|--|
| 1 | SGND | Ground of the Chip. |
| 2 | VC | Close Loop Compensation Node. |
| 3 | AND | Next Delay Timing Function Control. |
| 4 | SOURCE | Internal Power MOSFET Source Connection. |
| 5, 6 | DRAIN | Internal Power MOSFET Drain Connection. |
| 7 | NC | No Internal Connection. |
| 8 | VCC | Supply Voltage Input of the Chip. For good bypass, a ceramic capacitor near the VCC pin is required. |

Function Block Diagram

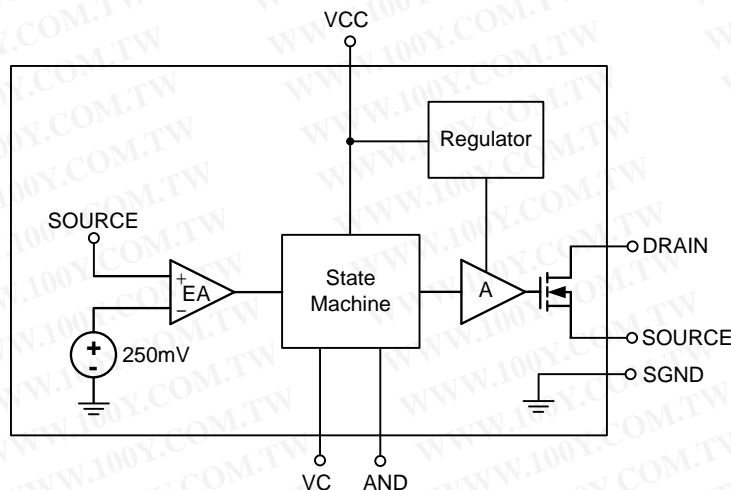

Operation

The RT8497 senses true average output current and keeps the system driving constant output current. The VC pin is the compensation node in this close loop

system and dominates the frequency response. To stabilize the system and achieve better PFC / THDi, proper selection of a compensation network is needed.

Absolute Maximum Ratings (Note 1)

- Supply Input Voltage ----- 40V
- DRAIN to SOURCE Voltage, V_{DS} , (RT8497B) ----- -0.3V to 550V
- DRAIN to SOURCE Voltage, V_{DS} , (RT8497C) ----- 550V
- DRAIN to SOURCE Voltage, V_{DS} , (RT8497, RT8497A) ----- -0.3V to 500V
- DRAIN Current, I_D @ $T_C = 25^\circ\text{C}$ ----- 1.4A
- DRAIN Current, I_D @ $T_C = 100^\circ\text{C}$ ----- 0.9A
- Power Dissipation, P_D @ $T_A = 25^\circ\text{C}$
SOP-8 ----- 0.53W
- Package Thermal Resistance (Note 2)
SOP-8, θ_{JA} ----- 188°C/W
- Lead Temperature (Soldering, 10 sec.) ----- 260°C
- Junction Temperature ----- 150°C
- Storage Temperature Range ----- -65°C to 150°C
- ESD Susceptibility (Note 3)
HBM (Human Body Model) ----- 2kV
MM (Machine Model) ----- 200V

Recommended Operating Conditions (Note 4)

- Supply Input Voltage ----- 10V to 30V
- Ambient Temperature Range ----- -40°C to 85°C
- Junction Temperature Range ----- -40°C to 125°C

Electrical Characteristics

($V_{CC} = 24\text{V}$, $T_A = 25^\circ\text{C}$, unless otherwise specified)

| Parameter | Symbol | Test Conditions | Min | Typ | Max | Unit | |
|-----------------------------------|-----------------|--|---------|-----|-------|---------------|----------|
| VCC UVLO ON | V_{UVLO_ON} | | 17 | 18 | 19 | V | |
| VCC UVLO OFF | V_{UVLO_OFF} | | 6.4 | 7.2 | 8 | V | |
| VCC Shut Down Current | I_{SHDN} | $V_{CC} = 15\text{V}$ | -- | -- | 1 | μA | |
| VCC Quiescent Current | I_Q | Drain stands still | -- | 0.5 | 5 | mA | |
| VCC Operating Current | I_{CC} | By $C_{GATE} = 1\text{nF}$, Freq. = 20kHz | -- | 1 | 5 | mA | |
| VCC OVP Level | V_{OVP} | | -- | 34 | -- | V | |
| Current Sense Threshold | V_{SENSE} | | 242.5 | 250 | 257.5 | mV | |
| AND Pin Leakage Current | I_{AND} | $V_{AND} = 5\text{V}$ | -- | 1 | 2 | μA | |
| Static Drain-Source On-Resistance | $R_{DS(ON)}$ | $V_{GS} = 12\text{V}$, $I_D = 100\text{mA}$ | RT8497 | -- | 5.2 | -- | Ω |
| | | | RT8497A | -- | 2 | -- | |
| | | | RT8497B | -- | 4.2 | -- | |
| | | | RT8497C | -- | 7 | -- | |

| Parameter | Symbol | Test Conditions | Min | Typ | Max | Unit |
|------------------------------|------------------|---------------------------------|-----|-----|-----|------|
| Drain-Source Leakage Current | I _{DSS} | RT8497, V _{DS} = 500V | -- | -- | 10 | μA |
| | | RT8497A, V _{DS} = 500V | | | | |
| | | RT8497B, V _{DS} = 600V | | | | |
| | | RT8497C, V _{DS} = 600V | | | | |

Note 1. Stresses beyond those listed “Absolute Maximum Ratings” may cause permanent damage to the device. These are stress ratings only, and functional operation of the device at these or any other conditions beyond those indicated in the operational sections of the specifications is not implied. Exposure to absolute maximum rating conditions may affect device reliability.

Note 2. θ_{JA} is measured at $T_A = 25^\circ\text{C}$ on a high effective thermal conductivity four-layer test board per JEDEC 51-7.

Note 3. Devices are ESD sensitive. Handling precaution recommended.

Note 4. The device is not guaranteed to function outside its operating conditions

Typical Application Circuit

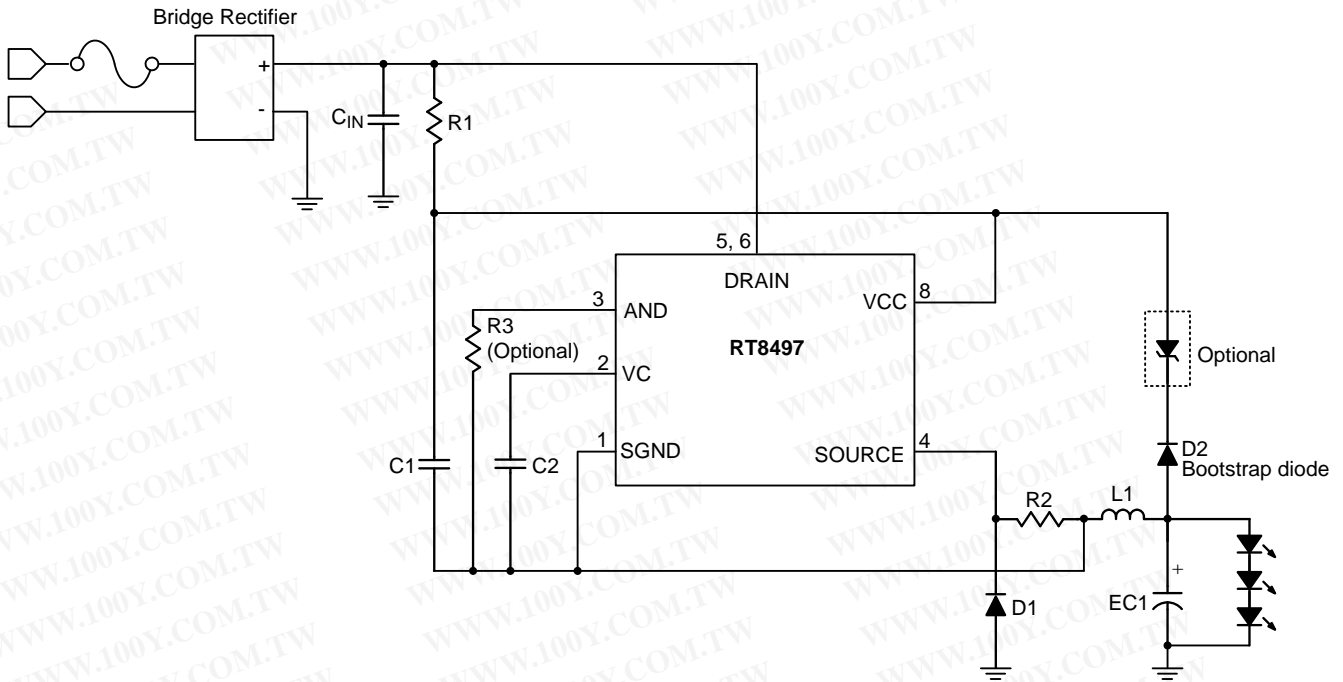
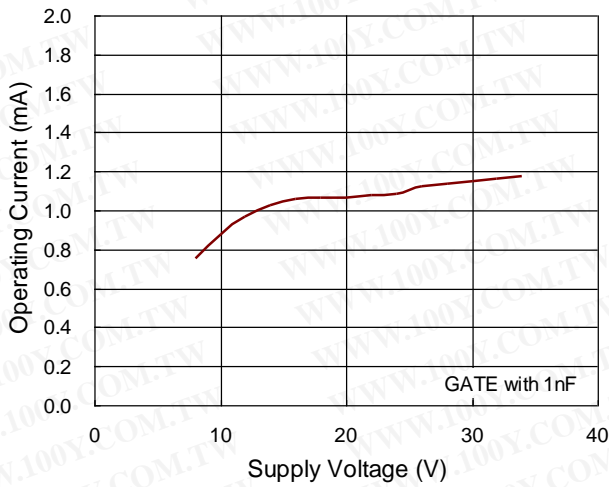

Figure 1. Typical Application of Buck Type

Typical Operating Characteristics

Operating Current vs. Supply Voltage



Operating Current vs. Temperature

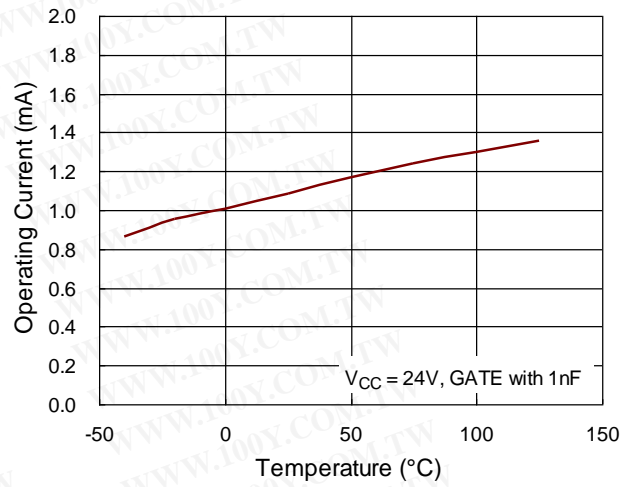

OVP vs. Temperature

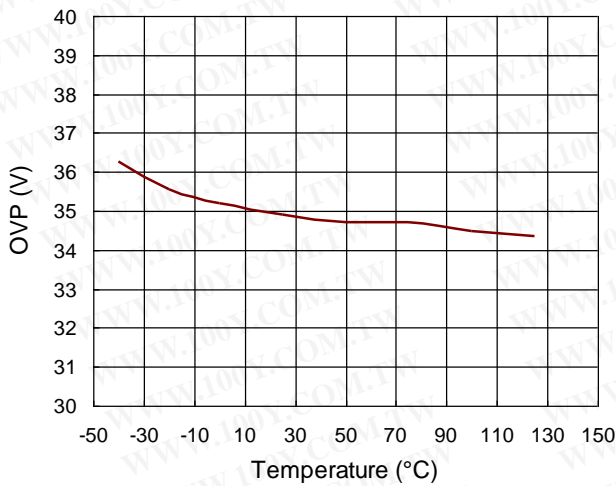

UVLO vs. Temperature

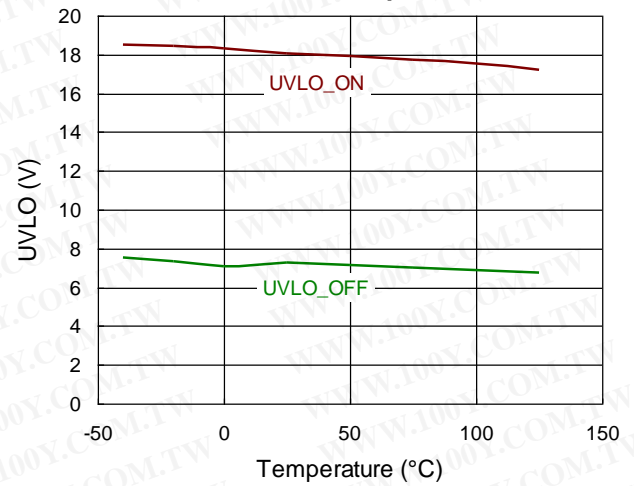

Sense Threshold vs. Supply Voltage

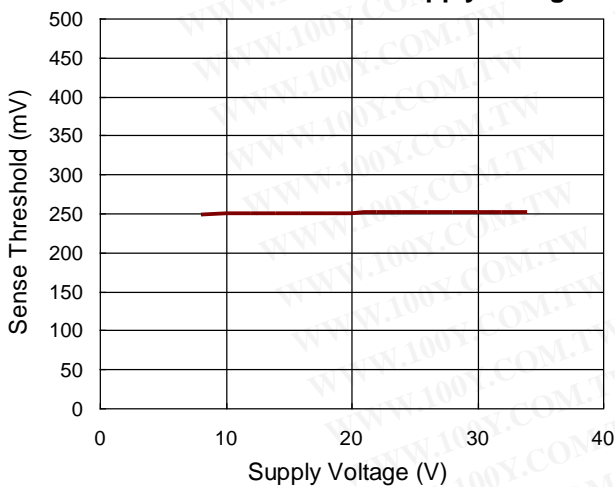

Sense Threshold vs. Temperature

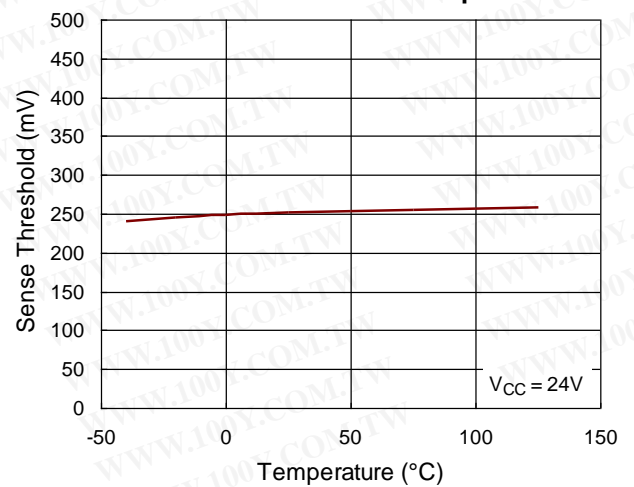

Efficiency vs. Input Voltage

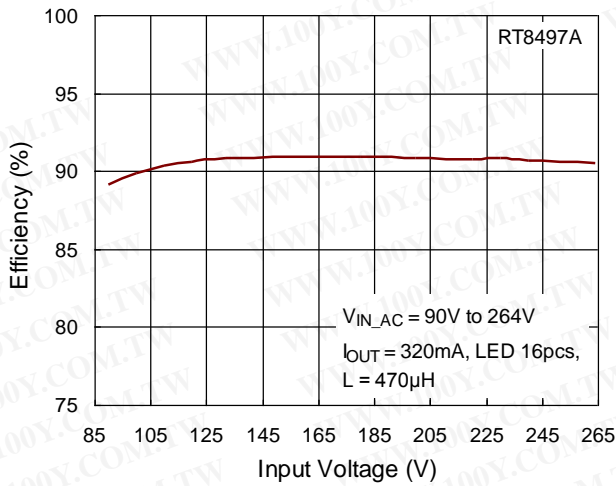

Output Current vs. Input Voltage

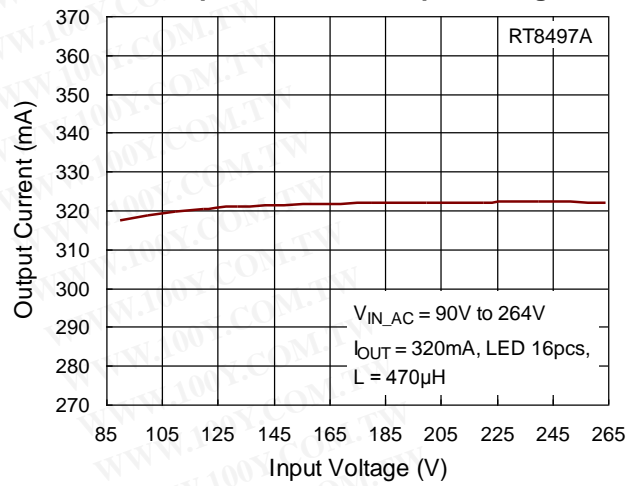

Power Factor vs. Input Voltage

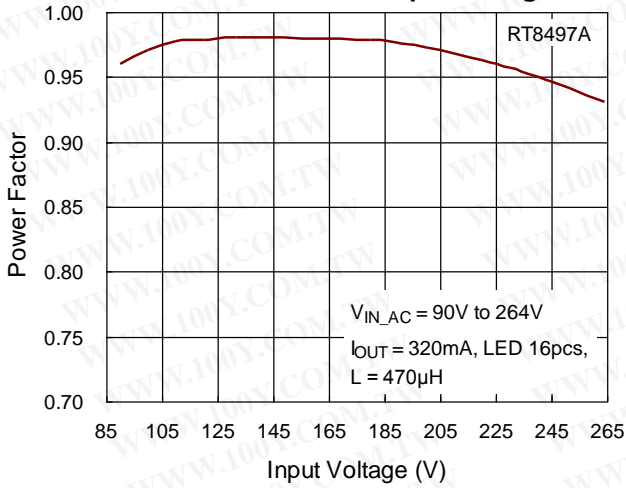

Input and Output Current

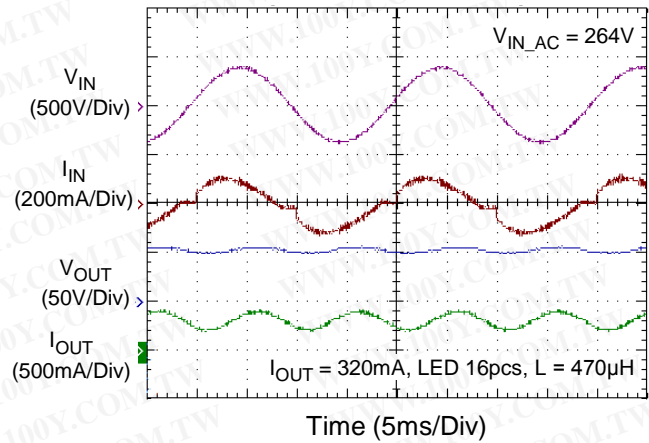

Power On

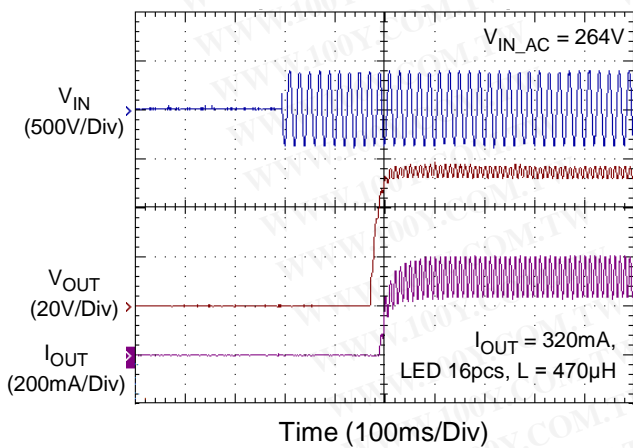

Power Off

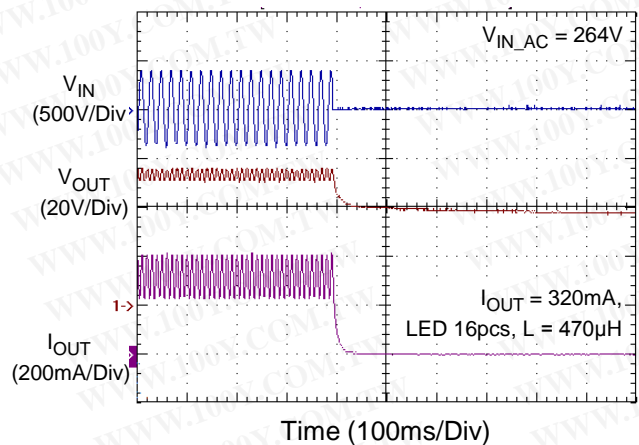

Total Harmonic Distortion

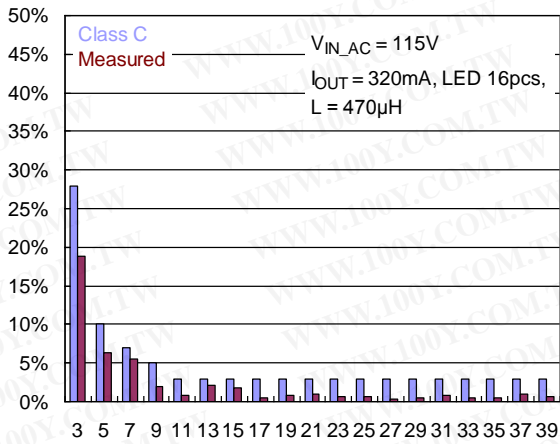

Total Harmonic Distortion

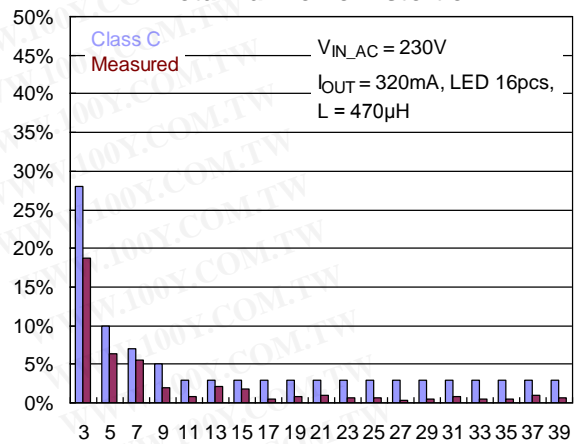

Application Information

RT8497 is a Boundary mode convertor, which can be used in buck configuration, to provide a constant output current to the (LED) load. It contains special circuitry for achieving high power factor and low input current THD, while minimizing external component count. The RT8497 integrates a power MOSFET and housed in a SOP-8 package. Thus, the components in the whole LED driver system can be made very compact.

The RT8497 can achieve high accuracy LED output current via the average current feedback loop control. The internal sense voltage (250mV typ.) is used to set the average output current. The average current is set by the external resistor, RS. The sense voltage is also used for over current protection (OCP) function. The typical OCP threshold is about seven times of the sense voltage threshold.

Under Voltage Lockout (UVLO)

The RT8497 includes a UVLO function with 10.8V hysteresis. For system start up, the VIN must rise over 18V (typ.) to turn on the internal MOSFET. The internal MOSFET will turn off if VIN falls below 7.2V (typ.)

Setting Average Output Current

The output current that flows through the LED string is set by an external resistor, RS, which is connected between the GND and SOURCE pins. The relationship between output current, IOUT, and RS is shown below :

$$I_{OUT} = \frac{250}{R_S}(\text{mA})$$

Start-up Resistor

The start-up resistor should be chosen to set the start up current exceeds certain minimum value. Otherwise, the RT8497 may latch off and the system will never start.

The start-up current equals $(\sqrt{2} \times 90V) / (R1 + R2)$ (for 110VAC regions), and equals $(\sqrt{2} \times 180V) / (R1 + R2)$ (for 220VAC regions). The typical required minimum start-up current is 100µA. The typical total start up resistance (R1+ R2) is around 1M Ohm for universal inputs.

Input Diode Bridge Rectifier Selection

The current rating of the input bridge rectifier is dependent on the VOUT /VIN conversion ratio and out LED current. The voltage rating of the input bridge rectifier, VBR, on the other hand, is only dependent on the input voltage. Thus, the VBR rating is calculated as below :

$$V_{BR} = 1.2 \times (\sqrt{2} \times V_{AC(MAX)})$$

where VAC(MAX) is the maximum input voltage (RMS) and the parameter 1.2 is used for safety margin.

For this example :

$$V_{BR} = 1.2 \times (\sqrt{2} \times V_{AC(MAX)}) = (1.2 \times \sqrt{2} \times 264) = 448V$$

If the input source is universal, VBR will reach 448V. In this case, a 600V, 0.5A bridge rectifier can be chosen.

Input Capacitor Selection

For High Power Factor application, the input Capacitor CIN should use a small value capacitance to achieve line voltage sine-wave.

The voltage rating of the input filter capacitor, VCIN, should be large enough to handle the input voltage. $V_{CIN} \geq (1.2 \times 2 \times V_{AC(MAX)}) = (1.2 \times 2 \times 264) = 448V$ Thus, a 0.1µF / 500V film capacitor can be chosen in this case.

Inductor Selection

For high power factor application, the RT8497 operates the converter in BCM (Boundary-Condition Mode). The inductance range is defined by peak current of inductor , maximum and minimum value of switching on time and off time, for ensuring the inductor operates in BCM. The peak current of inductor is showed as below :

$$I_{PEAK} = \frac{2Pin}{V_{PEAK}F(a)}$$

where $a = \frac{V_{OUT}}{V_{PEAK}}$

and

$$F(a) \approx -0.411a^4 + 0.296a^3 - 0.312a^2 + 0.638a - 0.0000846, \{a|0 \sim 0.7\}$$

The inductance range is showed as below :

$$L = \frac{V_{OUT} T_{OFF}}{I_{PEAK}} = \frac{(V_{PEAK} - V_{OUT}) T_{ON}}{I_{PEAK}}$$

Where $0.5\mu s \leq T_{ON} \leq 35\mu s$ and $2\mu s \leq T_{OFF} \leq 30\mu s$

The frequency at the top of the sine wave can be calculated :

$$f_{SW} = \frac{1}{T_{ON} + T_{OFF} + T_{DELAY}}$$

(T_{delay} is determined by the resistor connected to AND pin , see Turn on delay time)

Turn On Delay Time

After the inductor current has reached zero, a resonance will occur between the inductor and the MOSFET drain-source capacitance.

In order to minimize the MOSFET switching losses, RT8497 provides the flexibility to adjust the delay time of next switch-on cycle in order to switch-on at the maximum point of the resonance, which corresponds to the minimum drain-source voltage value.

The delay time from zero current point to the maximum of the switch resonance which can be calculated from :

$$T_{resonance} = \pi \sqrt{L1 \times C_{SW}}$$

where C_{SW} is the capacitance at the switch node, mostly determined by the MOSFET drain-source capacitance.

The delay time T_{DELAY} from zero current detection point to next MOSFET switch-on cycle can be adjusted by the resistor value R3B connected between AND pin and IC GND

$$T_{DELAY}(\mu s) = (-0.4 \times R3B^2 + 3500 \times R3B + 407500) \times 10^{-6}$$

R3B resistor value in k Ω .

Forward Diode Selection

When the power switch turns off, the path for the current is through the diode connected between the switch output and ground. This forward biased diode must have minimum voltage drop and recovery time. The reverse voltage rating of the diode should be greater than the maximum input voltage and the current rating should be greater than the maximum load current.

The peak voltage stress of diode is :

$$V_D \geq 1.2 \times (\sqrt{2} \times V_{AC(MAX)}) = 1.2 \times (\sqrt{2} \times 264) = 448V$$

The input source is universal ($V_{IN} = 85V$ to $264V$), V_D will reach 448V.

Thermal Protection (OTP)

A thermal protection feature is included to protect the RT8497 from excessive heat damage. When the junction temperature exceeds a threshold of $150^\circ C$, the thermal protection OTP will be triggered and the internal MOSFET will be turned off.

Thermal Considerations

For continuous operation, do not exceed absolute maximum junction temperature. The maximum power dissipation depends on the thermal resistance of the IC package, PCB layout, rate of surrounding airflow, and difference between junction and ambient temperature. The maximum power dissipation can be calculated by the following formula :

$$P_{D(MAX)} = (T_{J(MAX)} - T_A) / \theta_{JA}$$

where $T_{J(MAX)}$ is the maximum junction temperature, T_A is the ambient temperature, and θ_{JA} is the junction to ambient thermal resistance.

For recommended operating condition specifications, the maximum junction temperature is $125^\circ C$. The junction to ambient thermal resistance, θ_{JA} , is layout dependent. For SOP-8 package, the thermal resistance, θ_{JA} , is $188^\circ C/W$ on a standard JEDEC 51-7 four-layer thermal test board. The maximum power dissipation at $T_A = 25^\circ C$ can be calculated by the following formula :

$$P_{D(MAX)} = (125^\circ C - 25^\circ C) / (188^\circ C/W) = 0.53W \text{ for SOP-8 package}$$

The maximum power dissipation depends on the operating ambient temperature for fixed $T_{J(MAX)}$ and thermal resistance, θ_{JA} . The derating curve in Figure 2 allows the designer to see the effect of rising ambient temperature on the maximum power dissipation.



Figure 2. Derating Curve of Maximum Power Dissipation

Layout Considerations

For best performance of the RT8497, the following layout guidelines should be strictly followed.

The hold up capacitor, C1, must be placed as close as possible to the VCC pin.

The compensation capacitor, C2, and delay resistor, R3B, must be placed as close as possible to the VC and the AND pin.

The IC SOURCE pin are high frequency switching nodes. The traces must be as wide and short as possible.

Keep the main traces with switching current as short and wide as possible.

Place C_{IN}, L1, R_S, C_{OUT}, and D1 as close to each other as possible.

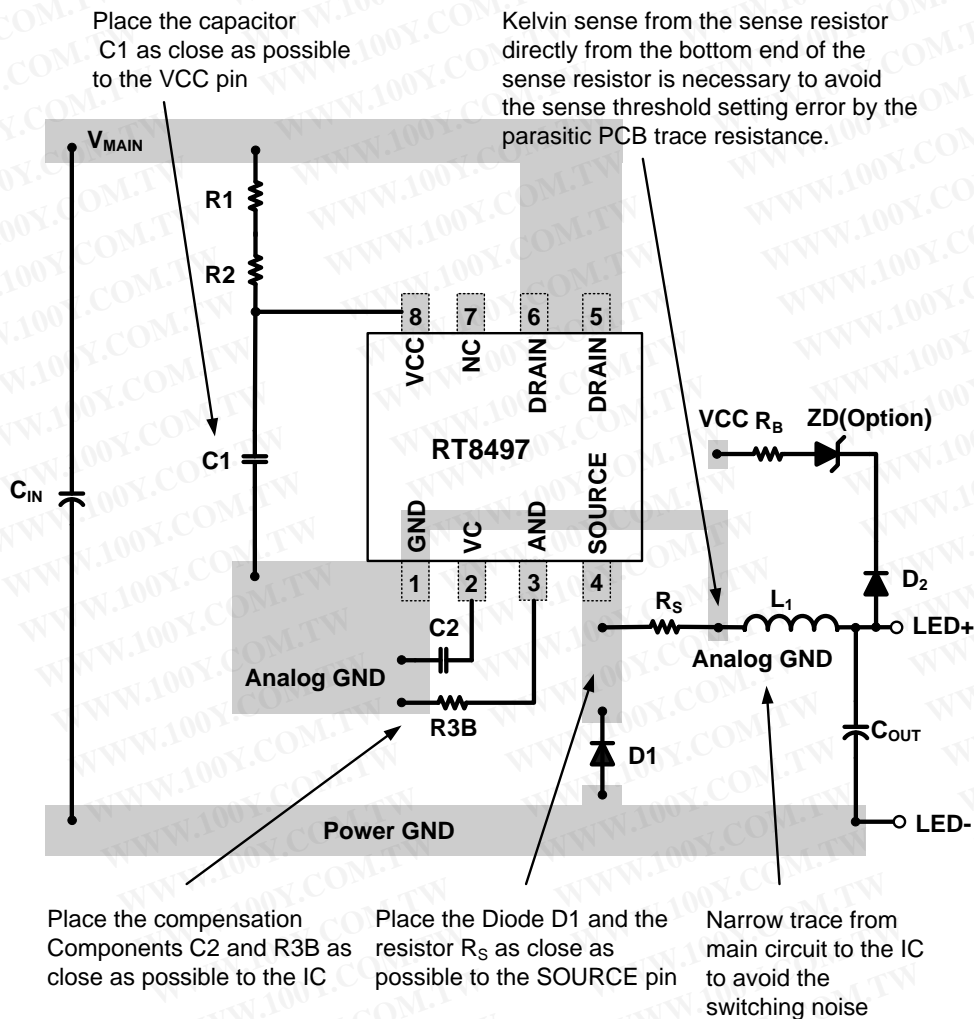
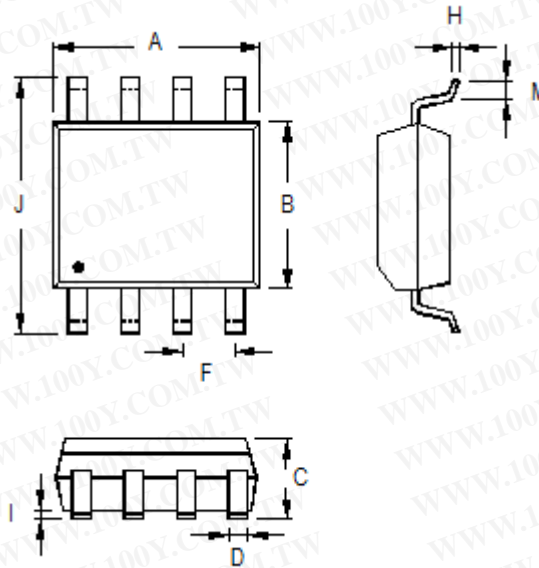

Figure 3. PCB Layout Guide

Outline Dimension



| Symbol | Dimensions In Millimeters | | Dimensions In Inches | |
|--------|---------------------------|-------|----------------------|-------|
| | Min | Max | Min | Max |
| A | 4.801 | 5.004 | 0.189 | 0.197 |
| B | 3.810 | 3.988 | 0.150 | 0.157 |
| C | 1.346 | 1.753 | 0.053 | 0.069 |
| D | 0.330 | 0.508 | 0.013 | 0.020 |
| F | 1.194 | 1.346 | 0.047 | 0.053 |
| H | 0.170 | 0.254 | 0.007 | 0.010 |
| I | 0.050 | 0.254 | 0.002 | 0.010 |
| J | 5.791 | 6.200 | 0.228 | 0.244 |
| M | 0.400 | 1.270 | 0.016 | 0.050 |

8-Lead SOP Plastic Package

勝特力材料 886-3-5753170
 勝特力电子(上海) 86-21-34970699
 勝特力电子(深圳) 86-755-83298787
[Http://www.100y.com.tw](http://www.100y.com.tw)

Richtek Technology Corporation

14F, No. 8, Tai Yuen 1st Street, Chupei City
 Hsinchu, Taiwan, R.O.C.
 Tel: (8863)5526789

Richtek products are sold by description only. Richtek reserves the right to change the circuitry and/or specifications without notice at any time. Customers should obtain the latest relevant information and data sheets before placing orders and should verify that such information is current and complete. Richtek cannot assume responsibility for use of any circuitry other than circuitry entirely embodied in a Richtek product. Information furnished by Richtek is believed to be accurate and reliable. However, no responsibility is assumed by Richtek or its subsidiaries for its use; nor for any infringements of patents or other rights of third parties which may result from its use. No license is granted by implication or otherwise under any patent or patent rights of Richtek or its subsidiaries.

Copyright © 2015 Richtek Technology Corporation. All rights reserved. **RICHTEK** is a registered trademark of Richtek Technology Corporation.