

FEATURES

Easy to use

Gain set with one external resistor
(Gain range 1 to 10,000)

Wide power supply range (± 2.3 V to ± 18 V)

Higher performance than 3 op amp IA designs

Available in 8-lead DIP and SOIC packaging

Low power, 1.3 mA max supply current

Excellent dc performance (B grade)

50 μ V max, input offset voltage

0.6 μ V/ $^{\circ}$ C max, input offset drift

1.0 nA max, input bias current

100 dB min common-mode rejection ratio (G = 10)

Low noise

9 nV/ $\sqrt{\text{Hz}}$ @ 1 kHz, input voltage noise

0.28 μ V p-p noise (0.1 Hz to 10 Hz)

Excellent ac specifications

120 kHz bandwidth (G = 100)

15 μ s settling time to 0.01%

APPLICATIONS

Weigh scales

ECG and medical instrumentation

Transducer interface

Data acquisition systems

Industrial process controls

Battery-powered and portable equipment

CONNECTION DIAGRAM



Figure 1. 8-Lead PDIP (N), CERDIP (Q), and SOIC (R) Packages

PRODUCT DESCRIPTION

The AD620 is a low cost, high accuracy instrumentation amplifier that requires only one external resistor to set gains of 1 to 10,000. Furthermore, the AD620 features 8-lead SOIC and DIP packaging that is smaller than discrete designs and offers lower power (only 1.3 mA max supply current), making it a good fit for battery-powered, portable (or remote) applications.

The AD620, with its high accuracy of 40 ppm maximum nonlinearity, low offset voltage of 50 μ V max, and offset drift of 0.6 μ V/ $^{\circ}$ C max, is ideal for use in precision data acquisition systems, such as weigh scales and transducer interfaces. Furthermore, the low noise, low input bias current, and low power of the AD620 make it well suited for medical applications, such as ECG and noninvasive blood pressure monitors.

The low input bias current of 1.0 nA max is made possible with the use of Superbeta processing in the input stage. The AD620 works well as a preamplifier due to its low input voltage noise of 9 nV/ $\sqrt{\text{Hz}}$ at 1 kHz, 0.28 μ V p-p in the 0.1 Hz to 10 Hz band, and 0.1 pA/ $\sqrt{\text{Hz}}$ input current noise. Also, the AD620 is well suited for multiplexed applications with its settling time of 15 μ s to 0.01%, and its cost is low enough to enable designs with one in-amp per channel.

Table 1. Next Generation Upgrades for AD620

Part	Comment
AD8221	Better specs at lower price
AD8222	Dual channel or differential out
AD8226	Low power, wide input range
AD8220	JFET input
AD8228	Best gain accuracy
AD8295	+2 precision op amps or differential out
AD8429	Ultra low noise



Figure 2. Three Op Amp IA Designs vs. AD620

Rev. H

Information furnished by Analog Devices is believed to be accurate and reliable. However, no responsibility is assumed by Analog Devices for its use, nor for any infringements of patents or other rights of third parties that may result from its use. Specifications subject to change without notice. No license is granted by implication or otherwise under any patent or patent rights of Analog Devices. Trademarks and registered trademarks are the property of their respective owners.

TABLE OF CONTENTS

Specifications3

Absolute Maximum Ratings5

 ESD Caution5

Typical Performance Characteristics6

Theory of Operation12

 Gain Selection.....15

 Input and Output Offset Voltage15

 Reference Terminal15

 Input Protection15

REVISION HISTORY

7/11—Rev. G to Rev. H

Deleted Figure 3.....1

Added Table 11

Moved Figure 2.....1

Added ESD Input Diodes to Simplified Schematic12

Changes to Input Protection Section.....15

Added Figure 41; Renumbered Sequentially.....15

Changes to AD620ACHIPS Information Section18

Updated Ordering Guide20

12/04—Rev. F to Rev. G

Updated Format..... Universal

Change to Features.....1

Change to Product Description.....1

Changes to Specifications.....3

Added Metallization Photograph.....4

Replaced Figure 4-Figure 66

Replaced Figure 157

Replaced Figure 3310

Replaced Figure 34 and Figure 3510

Replaced Figure 3710

Changes to Table 313

Changes to Figure 41 and Figure 4214

Changes to Figure 4315

Change to Figure 4417

RF Interference.....15

 Common-Mode Rejection.....16

 Grounding.....16

 Ground Returns for Input Bias Currents17

AD620ACHIPS Information18

Outline Dimensions.....19

 Ordering Guide20

Changes to Input Protection section15

Deleted Figure 915

Changes to RF Interference section.....15

Edit to Ground Returns for Input Bias Currents section.....17

Added AD620CHIPS to Ordering Guide19

7/03—Data Sheet Changed from Rev. E to Rev. F

Edit to FEATURES.....1

Changes to SPECIFICATIONS2

Removed AD620CHIPS from ORDERING GUIDE4

Removed METALLIZATION PHOTOGRAPH.....4

Replaced TPCs 1–35

Replaced TPC 126

Replaced TPC 309

Replaced TPCs 31 and 32.....10

Replaced Figure 4.....10

Changes to Table I.....11

Changes to Figures 6 and 712

Changes to Figure 813

Edited INPUT PROTECTION section.....13

Added new Figure 9.....13

Changes to RF INTERFACE section14

Edit to GROUND RETURNS FOR INPUT BIAS CURRENTS section.....15

Updated OUTLINE DIMENSIONS16

SPECIFICATIONS

Typical @ 25°C, $V_S = \pm 15$ V, and $R_L = 2$ k Ω , unless otherwise noted.

Table 2.

Parameter	Conditions	AD620A			AD620B			AD620S ¹			Unit
		Min	Typ	Max	Min	Typ	Max	Min	Typ	Max	
GAIN	$G = 1 + (49.4 \text{ k}\Omega/R_G)$										
Gain Range		1		10,000	1		10,000	1		10,000	
Gain Error ²	$V_{OUT} = \pm 10$ V										
G = 1			0.03	0.10		0.01	0.02		0.03	0.10	%
G = 10			0.15	0.30		0.10	0.15		0.15	0.30	%
G = 100			0.15	0.30		0.10	0.15		0.15	0.30	%
G = 1000			0.40	0.70		0.35	0.50		0.40	0.70	%
Nonlinearity	$V_{OUT} = -10$ V to $+10$ V										
G = 1–1000	$R_L = 10$ k Ω		10	40		10	40		10	40	ppm
G = 1–100	$R_L = 2$ k Ω		10	95		10	95		10	95	ppm
Gain vs. Temperature											
G = 1				10			10			10	ppm/°C
Gain > 1 ²				–50			–50			–50	ppm/°C
VOLTAGE OFFSET	(Total RTI Error = $V_{OSI} + V_{OSO}/G$)										
Input Offset, V_{OSI}	$V_S = \pm 5$ V to ± 15 V		30	125		15	50		30	125	μ V
Overtemperature	$V_S = \pm 5$ V to ± 15 V			185			85			225	μ V
Average TC	$V_S = \pm 5$ V to ± 15 V		0.3	1.0		0.1	0.6		0.3	1.0	μ V/°C
Output Offset, V_{OSO}	$V_S = \pm 15$ V		400	1000		200	500		400	1000	μ V
Overtemperature	$V_S = \pm 5$ V to ± 15 V			1500			750			1500	μ V
Average TC	$V_S = \pm 5$ V to ± 15 V		5.0	15		2.5	7.0		5.0	15	μ V/°C
Offset Referred to the Input vs. Supply (PSR)	$V_S = \pm 2.3$ V to ± 18 V										
G = 1		80	100		80	100		80	100		dB
G = 10		95	120		100	120		95	120		dB
G = 100		110	140		120	140		110	140		dB
G = 1000		110	140		120	140		110	140		dB
INPUT CURRENT											
Input Bias Current			0.5	2.0		0.5	1.0		0.5	2	nA
Overtemperature				2.5			1.5			4	nA
Average TC			3.0			3.0			8.0		pA/°C
Input Offset Current			0.3	1.0		0.3	0.5		0.3	1.0	nA
Overtemperature				1.5			0.75			2.0	nA
Average TC			1.5			1.5			8.0		pA/°C
INPUT											
Input Impedance											
Differential			10 2			10 2			10 2		G Ω _pF
Common-Mode			10 2			10 2			10 2		G Ω _pF
Input Voltage Range ³	$V_S = \pm 2.3$ V to ± 5 V	$-V_S + 1.9$		$+V_S - 1.2$	$-V_S + 1.9$		$+V_S - 1.2$	$-V_S + 1.9$		$+V_S - 1.2$	V
Overtemperature	$V_S = \pm 5$ V to ± 18 V	$-V_S + 2.1$		$+V_S - 1.3$	$-V_S + 2.1$		$+V_S - 1.3$	$-V_S + 2.1$		$+V_S - 1.3$	V
Overtemperature		$-V_S + 1.9$		$+V_S - 1.4$	$-V_S + 1.9$		$+V_S - 1.4$	$-V_S + 1.9$		$+V_S - 1.4$	V
Overtemperature		$-V_S + 2.1$		$+V_S - 1.4$	$-V_S + 2.1$		$+V_S + 2.1$	$-V_S + 2.3$		$+V_S - 1.4$	V

AD620

Parameter	Conditions	AD620A			AD620B			AD620S ¹			Unit
		Min	Typ	Max	Min	Typ	Max	Min	Typ	Max	
Common-Mode Rejection											
Ratio DC to 60 Hz with 1 kΩ Source Imbalance	$V_{CM} = 0\text{ V to } \pm 10\text{ V}$										
G = 1		73	90		80	90		73	90		dB
G = 10		93	110		100	110		93	110		dB
G = 100		110	130		120	130		110	130		dB
G = 1000		110	130		120	130		110	130		dB
OUTPUT											
Output Swing	$R_L = 10\text{ k}\Omega$ $V_S = \pm 2.3\text{ V}$ to $\pm 5\text{ V}$	$-V_S + 1.1$	$+V_S - 1.2$		$-V_S + 1.1$	$+V_S - 1.2$		$-V_S + 1.1$	$+V_S - 1.2$		V
Overtemperature		$-V_S + 1.4$	$+V_S - 1.3$		$-V_S + 1.4$	$+V_S - 1.3$		$-V_S + 1.6$	$+V_S - 1.3$		V
Overtemperature	$V_S = \pm 5\text{ V}$ to $\pm 18\text{ V}$	$-V_S + 1.2$	$+V_S - 1.4$		$-V_S + 1.2$	$+V_S - 1.4$		$-V_S + 1.2$	$+V_S - 1.4$		V
Short Circuit Current		$-V_S + 1.6$	$+V_S - 1.5$		$-V_S + 1.6$	$+V_S - 1.5$		$-V_S + 2.3$	$+V_S - 1.5$		V
		± 18			± 18			± 18			mA
DYNAMIC RESPONSE											
Small Signal -3 dB Bandwidth	10 V Step										
G = 1			1000			1000			1000		kHz
G = 10			800			800			800		kHz
G = 100			120			120			120		kHz
G = 1000			12			12			12		kHz
Slew Rate		0.75	1.2		0.75	1.2		0.75	1.2		V/ μs
Settling Time to 0.01%											
G = 1-100			15			15			15		μs
G = 1000			150			150			150		μs
NOISE											
Voltage Noise, 1 kHz	$Total\ RTI\ Noise = \sqrt{(e_{ni}^2) + (e_{no}/G)^2}$										
Input, Voltage Noise, e_{ni}			9	13		9	13		9	13	nV/ $\sqrt{\text{Hz}}$
Output, Voltage Noise, e_{no}			72	100		72	100		72	100	nV/ $\sqrt{\text{Hz}}$
RTI, 0.1 Hz to 10 Hz	$f = 1\text{ kHz}$										
G = 1			3.0			3.0	6.0		3.0	6.0	$\mu\text{V p-p}$
G = 10			0.55			0.55	0.8		0.55	0.8	$\mu\text{V p-p}$
G = 100-1000			0.28			0.28	0.4		0.28	0.4	$\mu\text{V p-p}$
Current Noise			100			100			100		fA/ $\sqrt{\text{Hz}}$
0.1 Hz to 10 Hz			10			10			10		pA p-p
REFERENCE INPUT											
R_{IN}	$V_{IN+}, V_{REF} = 0$	20			20			20			k Ω
I_{IN}		50	60		50	60		50	60		μA
Voltage Range		$-V_S + 1.6$	$+V_S - 1.6$		$-V_S + 1.6$	$+V_S - 1.6$		$-V_S + 1.6$	$+V_S - 1.6$		V
Gain to Output		1 ± 0.0001			1 ± 0.0001			1 ± 0.0001			
POWER SUPPLY											
Operating Range ⁴	$V_S = \pm 2.3\text{ V}$ to $\pm 18\text{ V}$	± 2.3	± 18		± 2.3	± 18		± 2.3	± 18		V
Quiescent Current		0.9	1.3		0.9	1.3		0.9	1.3		mA
Overtemperature		1.1	1.6		1.1	1.6		1.1	1.6		mA
TEMPERATURE RANGE											
For Specified Performance		$-40\text{ to }+85$			$-40\text{ to }+85$			$-55\text{ to }+125$			$^{\circ}\text{C}$

¹ See Analog Devices military data sheet for 883B tested specifications.

² Does not include effects of external resistor R_G .

³ One input grounded. $G = 1$.

⁴ This is defined as the same supply range that is used to specify PSR.

ABSOLUTE MAXIMUM RATINGS

Table 3.

Parameter	Rating
Supply Voltage	± 18 V
Internal Power Dissipation ¹	650 mW
Input Voltage (Common-Mode)	$\pm V_S$
Differential Input Voltage	25 V
Output Short-Circuit Duration	Indefinite
Storage Temperature Range (Q)	-65°C to $+150^{\circ}\text{C}$
Storage Temperature Range (N, R)	-65°C to $+125^{\circ}\text{C}$
Operating Temperature Range	
AD620 (A, B)	-40°C to $+85^{\circ}\text{C}$
AD620 (S)	-55°C to $+125^{\circ}\text{C}$
Lead Temperature Range (Soldering 10 seconds)	300°C

¹ Specification is for device in free air:
 8-Lead Plastic Package: $\theta_{JA} = 95^{\circ}\text{C}$
 8-Lead CERDIP Package: $\theta_{JA} = 110^{\circ}\text{C}$
 8-Lead SOIC Package: $\theta_{JA} = 155^{\circ}\text{C}$

Stresses above those listed under Absolute Maximum Ratings may cause permanent damage to the device. This is a stress rating only; functional operation of the device at these or any other conditions above those indicated in the operational section of this specification is not implied. Exposure to absolute maximum rating conditions for extended periods may affect device reliability.

ESD CAUTION



ESD (electrostatic discharge) sensitive device. Charged devices and circuit boards can discharge without detection. Although this product features patented or proprietary protection circuitry, damage may occur on devices subjected to high energy ESD. Therefore, proper ESD precautions should be taken to avoid performance degradation or loss of functionality.

TYPICAL PERFORMANCE CHARACTERISTICS

(@ 25°C, $V_s = \pm 15\text{ V}$, $R_L = 2\text{ k}\Omega$, unless otherwise noted.)



Figure 3. Typical Distribution of Input Offset Voltage



Figure 6. Input Bias Current vs. Temperature



Figure 4. Typical Distribution of Input Bias Current



Figure 7. Change in Input Offset Voltage vs. Warm-Up Time



Figure 5. Typical Distribution of Input Offset Current



Figure 8. Voltage Noise Spectral Density vs. Frequency ($G = 1-1000$)



Figure 9. Current Noise Spectral Density vs. Frequency

00775-0-011

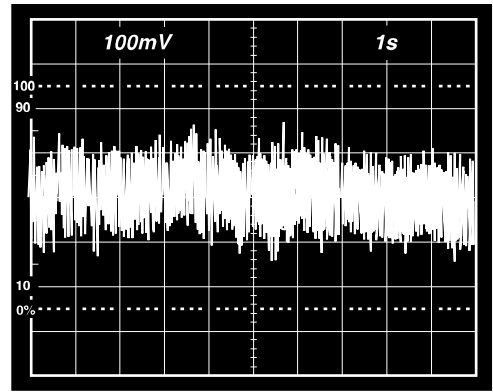

Figure 12. 0.1 Hz to 10 Hz Current Noise, 5 pA/Div

00775-0-014

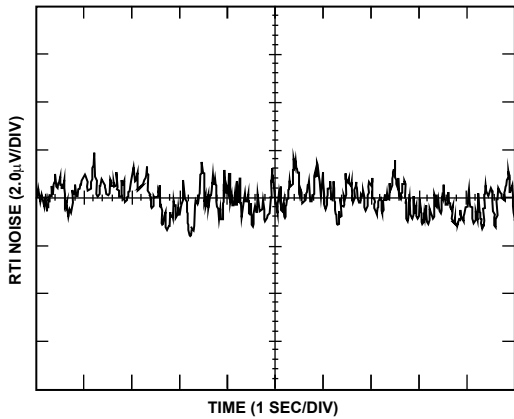

Figure 10. 0.1 Hz to 10 Hz RTI Voltage Noise (G = 1)

00775-0-012

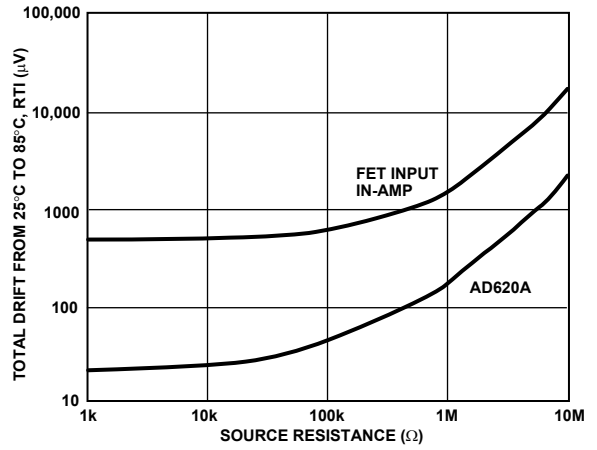

Figure 13. Total Drift vs. Source Resistance

00775-0-015

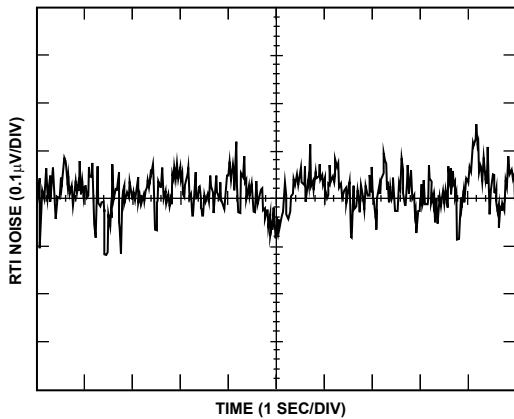

Figure 11. 0.1 Hz to 10 Hz RTI Voltage Noise (G = 1000)

00775-0-013

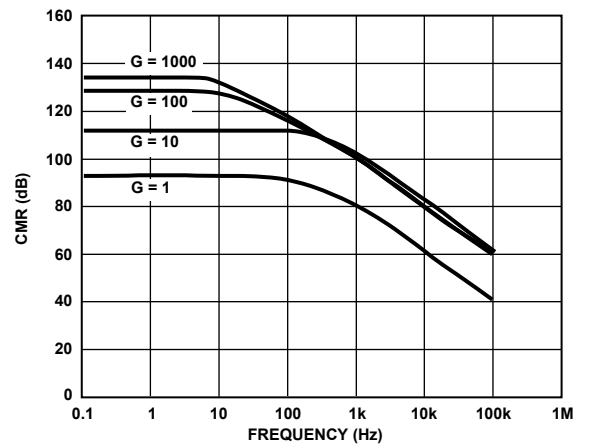

Figure 14. Typical CMR vs. Frequency, RTI, Zero to 1 kΩ Source Imbalance

00775-0-016

AD620

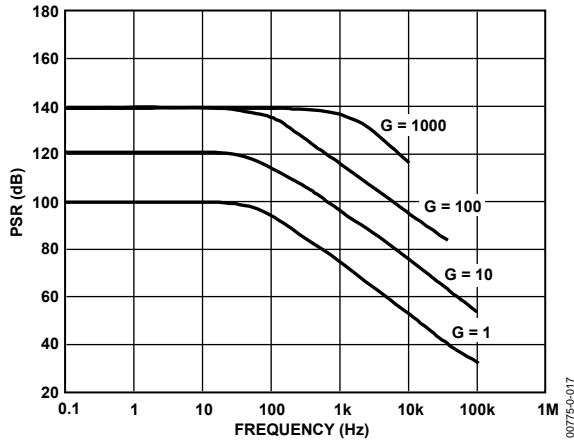

Figure 15. Positive PSR vs. Frequency, RTI (G = 1–1000)

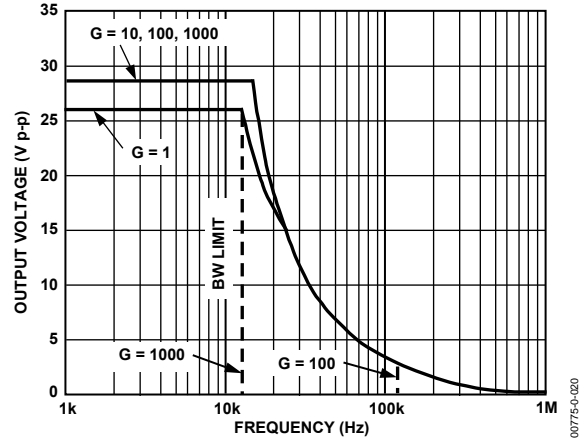

Figure 18. Large Signal Frequency Response

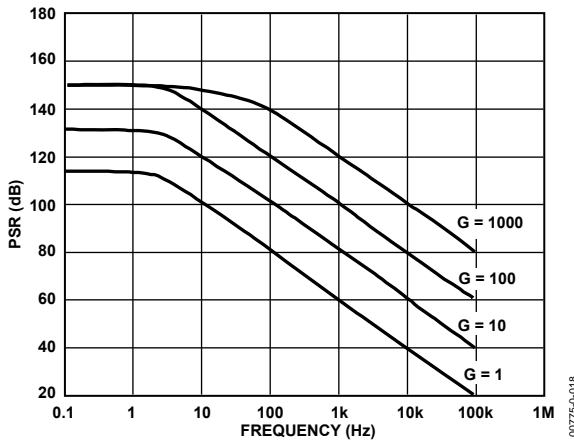

Figure 16. Negative PSR vs. Frequency, RTI (G = 1–1000)

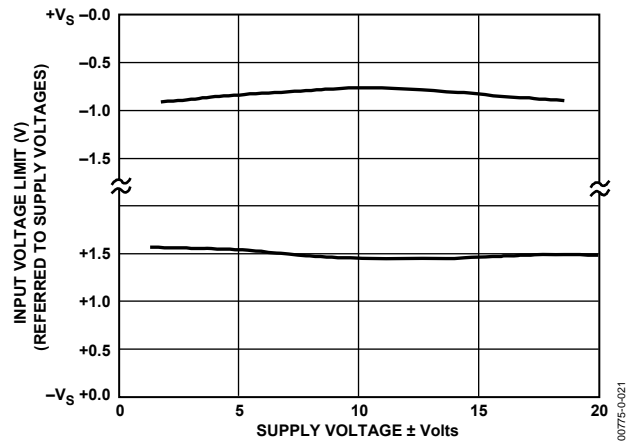

Figure 19. Input Voltage Range vs. Supply Voltage, G = 1



Figure 17. Gain vs. Frequency



Figure 20. Output Voltage Swing vs. Supply Voltage, G = 10



Figure 21. Output Voltage Swing vs. Load Resistance



Figure 24. Large Signal Response and Settling Time, $G = 10$ ($0.5 \text{ mV} = 0.01\%$)



Figure 22. Large Signal Pulse Response and Settling Time
 $G = 1$ ($0.5 \text{ mV} = 0.01\%$)



Figure 25. Small Signal Response, $G = 10$, $R_L = 2 \text{ k}\Omega$, $C_L = 100 \text{ pF}$



Figure 23. Small Signal Response, $G = 1$, $R_L = 2 \text{ k}\Omega$, $C_L = 100 \text{ pF}$



Figure 26. Large Signal Response and Settling Time, $G = 100$ ($0.5 \text{ mV} = 0.01\%$)



Figure 27. Small Signal Pulse Response, $G = 100$, $R_L = 2 \text{ k}\Omega$, $C_L = 100 \text{ pF}$

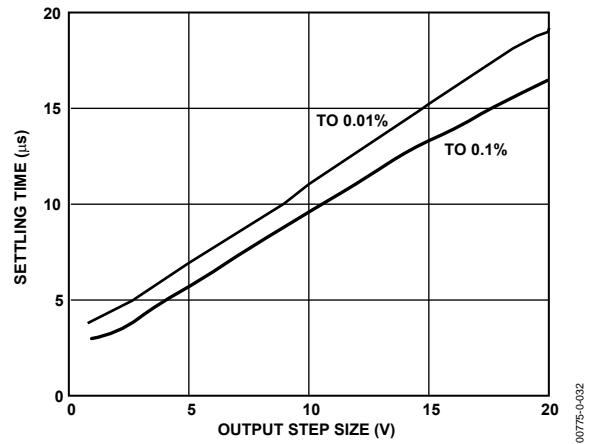

Figure 30. Settling Time vs. Step Size ($G = 1$)



Figure 28. Large Signal Response and Settling Time, $G = 1000$ ($0.5 \text{ mV} = 0.01\%$)

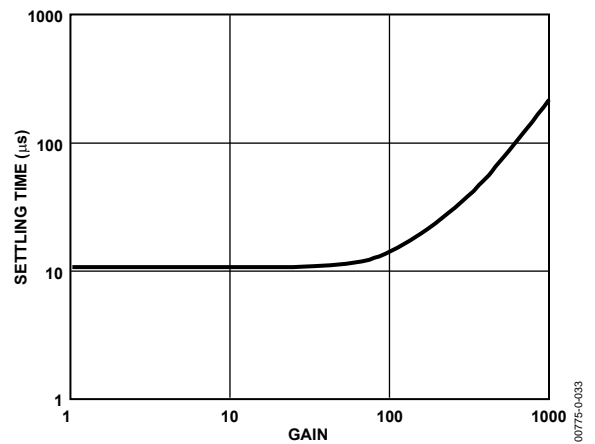

Figure 31. Settling Time to 0.01% vs. Gain, for a 10V Step



Figure 29. Small Signal Pulse Response, $G = 1000$, $R_L = 2 \text{ k}\Omega$, $C_L = 100 \text{ pF}$

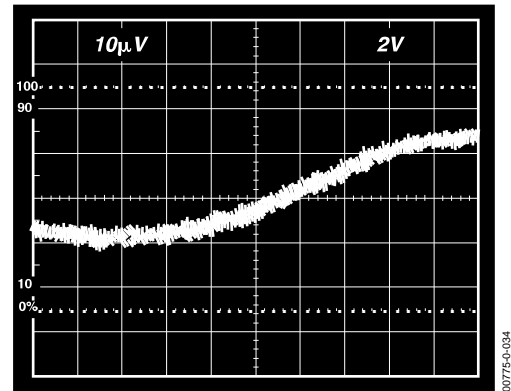

Figure 32. Gain Nonlinearity, $G = 1$, $R_L = 10 \text{ k}\Omega$ ($10 \text{ }\mu\text{V} = 1 \text{ ppm}$)



Figure 33. Gain Nonlinearity, $G = 100$, $R_L = 10\text{ k}\Omega$
 ($100\ \mu\text{V} = 10\text{ ppm}$)

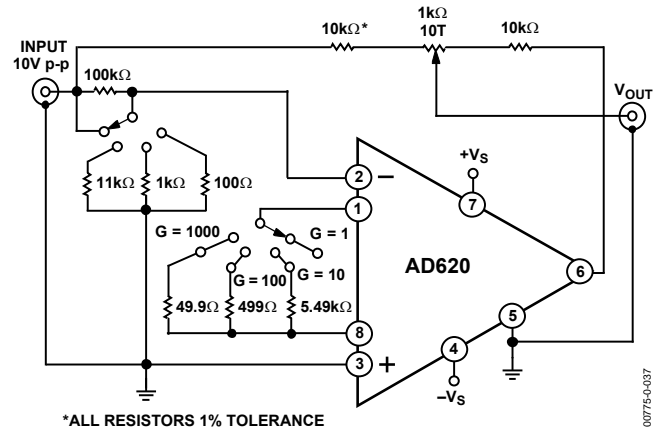

Figure 35. Settling Time Test Circuit

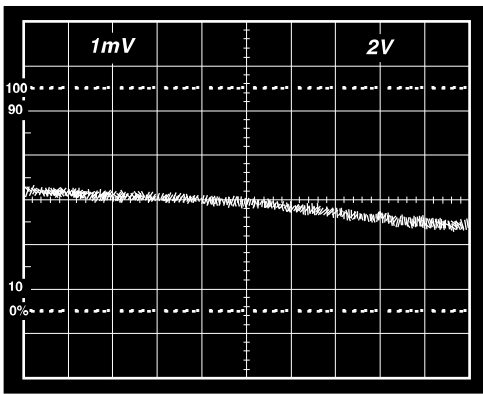

Figure 34. Gain Nonlinearity, $G = 1000$, $R_L = 10\text{ k}\Omega$
 ($1\text{ mV} = 100\text{ ppm}$)

THEORY OF OPERATION



Figure 36. Simplified Schematic of AD620

The AD620 is a monolithic instrumentation amplifier based on a modification of the classic three op amp approach. Absolute value trimming allows the user to program gain *accurately* (to 0.15% at $G = 100$) with only one resistor. Monolithic construction and laser wafer trimming allow the tight matching and tracking of circuit components, thus ensuring the high level of performance inherent in this circuit.

The input transistors Q1 and Q2 provide a single differential-pair bipolar input for high precision (Figure 36), yet offer $10\times$ lower input bias current thanks to Superbeta processing. Feedback through the Q1-A1-R1 loop and the Q2-A2-R2 loop maintains constant collector current of the input devices Q1 and Q2, thereby impressing the input voltage across the external gain setting resistor R_G . This creates a differential gain from the inputs to the A1/A2 outputs given by $G = (R1 + R2)/R_G + 1$. The unity-gain subtractor, A3, removes any common-mode signal, yielding a single-ended output referred to the REF pin potential.

The value of R_G also determines the transconductance of the preamp stage. As R_G is reduced for larger gains, the transconductance increases asymptotically to that of the input transistors. This has three important advantages: (a) Open-loop gain is boosted for increasing programmed gain, thus reducing gain related errors. (b) The gain-bandwidth product (determined by C1 and C2 and the preamp transconductance) increases with programmed gain, thus optimizing frequency response. (c) The input voltage noise is reduced to a value of $9 \text{ nV}/\sqrt{\text{Hz}}$, determined mainly by the collector current and base resistance of the input devices.

The internal gain resistors, R1 and R2, are trimmed to an absolute value of 24.7 kΩ, allowing the gain to be programmed accurately with a single external resistor.

The gain equation is then

$$G = \frac{49.4 \text{ k}\Omega}{R_G} + 1$$

$$R_G = \frac{49.4 \text{ k}\Omega}{G - 1}$$

Make vs. Buy: a Typical Bridge Application Error Budget

The AD620 offers improved performance over “homebrew” three op amp IA designs, along with smaller size, fewer components, and $10\times$ lower supply current. In the typical application, shown in Figure 37, a gain of 100 is required to amplify a bridge output of 20 mV full-scale over the industrial temperature range of -40°C to $+85^\circ\text{C}$. Table 4 shows how to calculate the effect various error sources have on circuit accuracy.

Regardless of the system in which it is being used, the AD620 provides greater accuracy at low power and price. In simple systems, absolute accuracy and drift errors are by far the most significant contributors to error. In more complex systems with an intelligent processor, an autogain/autozero cycle removes all absolute accuracy and drift errors, leaving only the resolution errors of gain, nonlinearity, and noise, thus allowing full 14-bit accuracy.

Note that for the homebrew circuit, the OP07 specifications for input voltage offset and noise have been multiplied by $\sqrt{2}$. This is because a three op amp type in-amp has two op amps at its inputs, both contributing to the overall input error.



PRECISION BRIDGE TRANSDUCER

00775-0-038



AD620A MONOLITHIC INSTRUMENTATION AMPLIFIER, G = 100
SUPPLY CURRENT = 1.3mA MAX

00775-0-040



"HOMEBREW" IN-AMP, G = 100
*0.02% RESISTOR MATCH, 3ppm/°C TRACKING
**DISCRETE 1% RESISTOR, 100ppm/°C TRACKING
SUPPLY CURRENT = 15mA MAX

00775-0-041

Figure 37. Make vs. Buy

Table 4. Make vs. Buy Error Budget

Error Source	AD620 Circuit Calculation	"Homebrew" Circuit Calculation	Error, ppm of Full Scale	
			AD620	Homebrew
ABSOLUTE ACCURACY at T_A = 25°C				
Input Offset Voltage, μV	125 $\mu\text{V}/20\text{ mV}$	$(150\ \mu\text{V} \times \sqrt{2})/20\text{ mV}$	6,250	10,607
Output Offset Voltage, μV	1000 $\mu\text{V}/100\text{ mV}/20\text{ mV}$	$((150\ \mu\text{V} \times 2)/100)/20\text{ mV}$	500	150
Input Offset Current, nA	2 nA $\times 350\ \Omega/20\text{ mV}$	$(6\text{ nA} \times 350\ \Omega)/20\text{ mV}$	18	53
CMR, dB	110 dB(3.16 ppm) $\times 5\text{ V}/20\text{ mV}$	$(0.02\% \text{ Match} \times 5\text{ V})/20\text{ mV}/100$	791	500
Total Absolute Error			7,559	11,310
DRIFT TO 85°C				
Gain Drift, ppm/°C	$(50\text{ ppm} + 10\text{ ppm}) \times 60^\circ\text{C}$	100 ppm/°C Track $\times 60^\circ\text{C}$	3,600	6,000
Input Offset Voltage Drift, $\mu\text{V}/^\circ\text{C}$	1 $\mu\text{V}/^\circ\text{C} \times 60^\circ\text{C}/20\text{ mV}$	$(2.5\ \mu\text{V}/^\circ\text{C} \times \sqrt{2} \times 60^\circ\text{C})/20\text{ mV}$	3,000	10,607
Output Offset Voltage Drift, $\mu\text{V}/^\circ\text{C}$	15 $\mu\text{V}/^\circ\text{C} \times 60^\circ\text{C}/100\text{ mV}/20\text{ mV}$	$(2.5\ \mu\text{V}/^\circ\text{C} \times 2 \times 60^\circ\text{C})/100\text{ mV}/20\text{ mV}$	450	150
Total Drift Error			7,050	16,757
RESOLUTION				
Gain Nonlinearity, ppm of Full Scale	40 ppm	40 ppm	40	40
Typ 0.1 Hz to 10 Hz Voltage Noise, $\mu\text{V p-p}$	0.28 $\mu\text{V p-p}/20\text{ mV}$	$(0.38\ \mu\text{V p-p} \times \sqrt{2})/20\text{ mV}$	14	27
Total Resolution Error			54	67
Grand Total Error			14,663	28,134

G = 100, V_s = $\pm 15\text{ V}$.

(All errors are min/max and referred to input.)

AD620



Figure 38. A Pressure Monitor Circuit that Operates on a 5 V Single Supply

00775-0-042

Pressure Measurement

Although useful in many bridge applications, such as weigh scales, the AD620 is especially suitable for higher resistance pressure sensors powered at lower voltages where small size and low power become more significant.

Figure 38 shows a 3 kΩ pressure transducer bridge powered from 5 V. In such a circuit, the bridge consumes only 1.7 mA. Adding the AD620 and a buffered voltage divider allows the signal to be conditioned for only 3.8 mA of total supply current.

Small size and low cost make the AD620 especially attractive for voltage output pressure transducers. Since it delivers low noise and drift, it also serves applications such as diagnostic noninvasive blood pressure measurement.

Medical ECG

The low current noise of the AD620 allows its use in ECG monitors (Figure 39) where high source resistances of 1 MΩ or higher are not uncommon. The AD620's low power, low supply voltage requirements, and space-saving 8-lead mini-DIP and SOIC package offerings make it an excellent choice for battery-powered data recorders.

Furthermore, the low bias currents and low current noise, coupled with the low voltage noise of the AD620, improve the dynamic range for better performance.

The value of capacitor C1 is chosen to maintain stability of the right leg drive loop. Proper safeguards, such as isolation, must be added to this circuit to protect the patient from possible harm.



Figure 39. A Medical ECG Monitor Circuit

00775-0-043

Precision V-I Converter

The AD620, along with another op amp and two resistors, makes a precision current source (Figure 40). The op amp buffers the reference terminal to maintain good CMR. The output voltage, V_x , of the AD620 appears across R_1 , which converts it to a current. This current, less only the input bias current of the op amp, then flows out to the load.



Figure 40. Precision Voltage-to-Current Converter (Operates on 1.8 mA, ± 3 V)

GAIN SELECTION

The AD620 gain is resistor-programmed by R_G , or more precisely, by whatever impedance appears between Pins 1 and 8. The AD620 is designed to offer accurate gains using 0.1% to 1% resistors. Table 5 shows required values of R_G for various gains. Note that for $G = 1$, the R_G pins are unconnected ($R_G = \infty$). For any arbitrary gain, R_G can be calculated by using the formula:

$$R_G = \frac{49.4k\Omega}{G-1}$$

To minimize gain error, avoid high parasitic resistance in series with R_G ; to minimize gain drift, R_G should have a low TC—less than 10 ppm/ $^{\circ}$ C—for the best performance.

Table 5. Required Values of Gain Resistors

1% Std Table Value of $R_G(\Omega)$	Calculated Gain	0.1% Std Table Value of $R_G(\Omega)$	Calculated Gain
49.9 k	1.990	49.3 k	2.002
12.4 k	4.984	12.4 k	4.984
5.49 k	9.998	5.49 k	9.998
2.61 k	19.93	2.61 k	19.93
1.00 k	50.40	1.01 k	49.91
499	100.0	499	100.0
249	199.4	249	199.4
100	495.0	98.8	501.0
49.9	991.0	49.3	1,003.0

INPUT AND OUTPUT OFFSET VOLTAGE

The low errors of the AD620 are attributed to two sources, input and output errors. The output error is divided by G when referred to the input. In practice, the input errors dominate at high gains, and the output errors dominate at low gains. The total V_{OS} for a given gain is calculated as

$$\text{Total Error RTI} = \text{input error} + (\text{output error}/G)$$

$$\text{Total Error RTO} = (\text{input error} \times G) + \text{output error}$$

REFERENCE TERMINAL

The reference terminal potential defines the zero output voltage and is especially useful when the load does not share a precise ground with the rest of the system. It provides a direct means of injecting a precise offset to the output, with an allowable range of 2 V within the supply voltages. Parasitic resistance should be kept to a minimum for optimum CMR.

INPUT PROTECTION

The AD620 safely withstands an input current of ± 60 mA for several hours at room temperature. This is true for all gains and power on and off, which is useful if the signal source and amplifier are powered separately. For longer time periods, the input current should not exceed 6 mA.

For input voltages beyond the supplies, a protection resistor should be placed in series with each input to limit the current to 6 mA. These can be the same resistors as those used in the RFI filter. High values of resistance can impact the noise and AC CMRR performance of the system. Low leakage diodes (such as the BAV199) can be placed at the inputs to reduce the required protection resistance.



Figure 41. Diode Protection for Voltages Beyond Supply

RF INTERFERENCE

All instrumentation amplifiers rectify small out of band signals. The disturbance may appear as a small dc voltage offset. High frequency signals can be filtered with a low pass R-C network placed at the input of the instrumentation amplifier. Figure 42 demonstrates such a configuration. The filter limits the input

AD620

signal according to the following relationship:

$$FilterFreq_{DIFF} = \frac{1}{2\pi R(2C_D + C_C)}$$

$$FilterFreq_{CM} = \frac{1}{2\pi RC_C}$$

where $C_D \geq 10C_C$.

C_D affects the difference signal. C_C affects the common-mode signal. Any mismatch in $R \times C_C$ degrades the AD620 CMRR. To avoid inadvertently reducing CMRR-bandwidth performance, make sure that C_C is at least one magnitude smaller than C_D . The effect of mismatched C_C s is reduced with a larger $C_D:C_C$ ratio.



Figure 42. Circuit to Attenuate RF Interference

COMMON-MODE REJECTION

Instrumentation amplifiers, such as the AD620, offer high CMR, which is a measure of the change in output voltage when both inputs are changed by equal amounts. These specifications are usually given for a full-range input voltage change and a specified source imbalance.

For optimal CMR, the reference terminal should be tied to a low impedance point, and differences in capacitance and resistance should be kept to a minimum between the two inputs. In many applications, shielded cables are used to minimize noise; for best CMR over frequency, the shield should be properly driven. Figure 43 and Figure 44 show active data guards that are configured to improve ac common-mode rejections by “bootstrapping” the capacitances of input cable shields, thus minimizing the capacitance mismatch between the inputs.



Figure 43. Differential Shield Driver

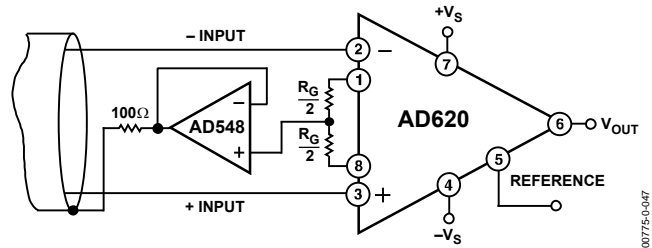

Figure 44. Common-Mode Shield Driver

GROUNDING

Since the AD620 output voltage is developed with respect to the potential on the reference terminal, it can solve many grounding problems by simply tying the REF pin to the appropriate “local ground.”

To isolate low level analog signals from a noisy digital environment, many data-acquisition components have separate analog and digital ground pins (Figure 45). It would be convenient to use a single ground line; however, current through ground wires and PC runs of the circuit card can cause hundreds of millivolts of error. Therefore, separate ground returns should be provided to minimize the current flow from the sensitive points to the system ground. These ground returns must be tied together at some point, usually best at the ADC package shown in Figure 45.



Figure 45. Basic Grounding Practice

GROUND RETURNS FOR INPUT BIAS CURRENTS

Input bias currents are those currents necessary to bias the input transistors of an amplifier. There must be a direct return path for these currents. Therefore, when amplifying “floating” input sources, such as transformers or ac-coupled sources, there must be a dc path from each input to ground, as shown in Figure 46, Figure 47, and Figure 48. Refer to *A Designer’s Guide to Instrumentation Amplifiers* (free from Analog Devices) for more information regarding in-amp applications.



Figure 46. Ground Returns for Bias Currents with Transformer-Coupled Inputs



Figure 47. Ground Returns for Bias Currents with Thermocouple Inputs



Figure 48. Ground Returns for Bias Currents with AC-Coupled Inputs

AD620

AD620ACHIPS INFORMATION

Die size: 1803 μm \times 3175 μm

Die thickness: 483 μm

Bond Pad Metal: 1% Copper Doped Aluminum

To minimize gain errors introduced by the bond wires, use Kelvin connections between the chip and the gain resistor, R_G , by connecting Pad 1A and Pad 1B in parallel to one end of R_G and Pad 8A and Pad 8B in parallel to the other end of R_G . For unity gain applications where R_G is not required, Pad 1A and Pad 1B must be bonded together as well as the Pad 8A and Pad 8B.



Figure 49. Bond Pad Diagram

Table 6. Bond Pad Information

Pad No.	Mnemonic	Pad Coordinates ¹	
		X (μm)	Y (μm)
1A	R_G	-623	+1424
1B	R_G	-789	+628
2	-IN	-790	+453
3	+IN	-790	-294
4	$-V_S$	-788	-1419
5	REF	+570	-1429
6	OUTPUT	+693	-1254
7	$+V_S$	+693	+139
8A	R_G	+505	+1423
8B	R_G	+693	+372

¹ The pad coordinates indicate the center of each pad, referenced to the center of the die. The die orientation is indicated by the logo, as shown in Figure 49.

OUTLINE DIMENSIONS



COMPLIANT TO JEDEC STANDARDS MS-001
 CONTROLLING DIMENSIONS ARE IN INCHES; MILLIMETER DIMENSIONS (IN PARENTHESES) ARE ROUNDED-OFF INCH EQUIVALENTS FOR REFERENCE ONLY AND ARE NOT APPROPRIATE FOR USE IN DESIGN. CORNER LEADS MAY BE CONFIGURED AS WHOLE OR HALF LEADS.

Figure 50. 8-Lead Plastic Dual In-Line Package [PDIP] Narrow Body (N-8).
 Dimensions shown in inches and (millimeters)



COMPLIANT TO JEDEC STANDARDS MS-012-AA
 CONTROLLING DIMENSIONS ARE IN MILLIMETERS; INCH DIMENSIONS (IN PARENTHESES) ARE ROUNDED-OFF MILLIMETER EQUIVALENTS FOR REFERENCE ONLY AND ARE NOT APPROPRIATE FOR USE IN DESIGN.

Figure 52. 8-Lead Standard Small Outline Package [SOIC_N] Narrow Body (R-8)
 Dimensions shown in millimeters and (inches)



CONTROLLING DIMENSIONS ARE IN INCHES; MILLIMETER DIMENSIONS (IN PARENTHESES) ARE ROUNDED-OFF INCH EQUIVALENTS FOR REFERENCE ONLY AND ARE NOT APPROPRIATE FOR USE IN DESIGN.

Figure 51. 8-Lead Ceramic Dual In-Line Package [CERDIP] (Q-8)
 Dimensions shown in inches and (millimeters)

AD620

ORDERING GUIDE

Model ¹	Temperature Range	Package Description	Package Option
AD620AN	-40°C to +85°C	8-Lead PDIP	N-8
AD620ANZ	-40°C to +85°C	8-Lead PDIP	N-8
AD620BN	-40°C to +85°C	8-Lead PDIP	N-8
AD620BNZ	-40°C to +85°C	8-Lead PDIP	N-8
AD620AR	-40°C to +85°C	8-Lead SOIC_N	R-8
AD620ARZ	-40°C to +85°C	8-Lead SOIC_N	R-8
AD620AR-REEL	-40°C to +85°C	8-Lead SOIC_N, 13" Tape and Reel	R-8
AD620ARZ-REEL	-40°C to +85°C	8-Lead SOIC_N, 13" Tape and Reel	R-8
AD620AR-REEL7	-40°C to +85°C	8-Lead SOIC_N, 7" Tape and Reel	R-8
AD620ARZ-REEL7	-40°C to +85°C	8-Lead SOIC_N, 7" Tape and Reel	R-8
AD620BR	-40°C to +85°C	8-Lead SOIC_N	R-8
AD620BRZ	-40°C to +85°C	8-Lead SOIC_N	R-8
AD620BR-REEL	-40°C to +85°C	8-Lead SOIC_N, 13" Tape and Reel	R-8
AD620BRZ-RL	-40°C to +85°C	8-Lead SOIC_N, 13" Tape and Reel	R-8
AD620BR-REEL7	-40°C to +85°C	8-Lead SOIC_N, 7" Tape and Reel	R-8
AD620BRZ-R7	-40°C to +85°C	8-Lead SOIC_N, 7" Tape and Reel	R-8
AD620ACHIPS	-40°C to +85°C	Die Form	
AD620SQ/883B	-55°C to +125°C	8-Lead CERDIP	Q-8

¹ Z = RoHS Compliant Part.

Mouser Electronics

Authorized Distributor

Click to View Pricing, Inventory, Delivery & Lifecycle Information:

[Analog Devices Inc.:](#)

[AD620BNZ](#) [AD620ARZ-REEL](#) [AD620ANZ](#) [AD620BRZ-R7](#) [AD620AN](#) [AD620SQ/883B](#) [AD620AR-REEL](#)
[AD620ARZ-REEL7](#) [AD620AR-REEL7](#) [AD620BRZ-RL](#) [AD620BR-REEL7](#) [AD620BR](#) [AD620BRZ](#) [AD620ARZ](#)
[AD620AR](#) [AD620BR-REEL](#) [AD620BN](#)