



ON Semiconductor®

FDS6612A

Single N-Channel, Logic-Level, PowerTrench® MOSFET

General Description

This N-Channel Logic Level MOSFET is produced using ON Semiconductor's advanced PowerTrench process that has been especially tailored to minimize the on-state resistance and yet maintain superior switching performance.

These devices are well suited for low voltage and battery powered applications where low in-line power loss and fast switching are required.



Features

- 8.4 A, 30 V. $R_{DS(ON)} = 22\text{ m}\Omega @ V_{GS} = 10\text{ V}$
 $R_{DS(ON)} = 30\text{ m}\Omega @ V_{GS} = 4.5\text{ V}$
- Fast switching speed
- Low gate charge
- High performance trench technology for extremely low $R_{DS(ON)}$
- High power and current handling capability

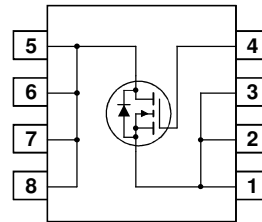
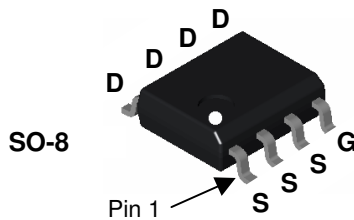

Absolute Maximum Ratings T_A=25°C unless otherwise noted

Symbol	Parameter	Ratings	Units
V _{DSS}	Drain-Source Voltage	30	V
V _{GSS}	Gate-Source Voltage	±20	V
I _D	Drain Current – Continuous (Note 1a)	8.4	A
		40	
P _D	Power Dissipation for Single Operation (Note 1a)	2.5	W
		1.0	
E _{AS}	Single Pulse Avalanche Energy (Note 3)	24	mJ
T _J , T _{STG}	Operating and Storage Junction Temperature Range	-55 to +150	°C

Thermal Characteristics

R _{θJA}	Thermal Resistance, Junction-to-Ambient (Note 1a)	50	°C/W
R _{θJA}	Thermal Resistance, Junction-to-Ambient (Note 1b)	125	
R _{θJC}	Thermal Resistance, Junction-to-Case (Note 1)	25	

Package Marking and Ordering Information

Device Marking	Device	Reel Size	Tape width	Quantity
FDS6612A	FDS6612A	13"	12mm	2500 units

Electrical Characteristics

T_A = 25°C unless otherwise noted

Symbol	Parameter	Test Conditions	Min	Typ	Max	Units
--------	-----------	-----------------	-----	-----	-----	-------

Off Characteristics

BV _{DSS}	Drain-Source Breakdown Voltage	V _{GS} = 0 V, I _D = 250 μA	30			V
$\frac{\Delta BV_{DSS}}{\Delta T_J}$	Breakdown Voltage Temperature Coefficient	I _D = 250 μA, Referenced to 25°C		26		mV/°C
I _{DSS}	Zero Gate Voltage Drain Current	V _{DS} = 24 V, V _{GS} = 0 V			1	μA
		V _{DS} = 24 V, V _{GS} = 0 V, T _J = 55°C			10	μA
I _{GSS}	Gate-Body Leakage	V _{GS} = ±20 V, V _{DS} = 0 V			±100	nA

On Characteristics (Note 2)

V _{GS(th)}	Gate Threshold Voltage	V _{DS} = V _{GS} , I _D = 250 μA	1	1.9	3	V
$\frac{\Delta V_{GS(th)}}{\Delta T_J}$	Gate Threshold Voltage Temperature Coefficient	I _D = 250 μA, Referenced to 25°C		-4.4		mV/°C
R _{DS(on)}	Static Drain-Source On-Resistance	V _{GS} = 10 V, I _D = 8.4 A V _{GS} = 4.5 V, I _D = 7.2 A V _{GS} = 10 V, I _D = 8.4 A, T _J = 125°C		19 24 25	22 30 37	mΩ
I _{D(on)}	On-State Drain Current	V _{GS} = 10 V, V _{DS} = 5 V	20			A
g _{FS}	Forward Transconductance	V _{DS} = 15 V, I _D = 8.4 A		30		S

Dynamic Characteristics

C _{iss}	Input Capacitance	V _{DS} = 15 V, V _{GS} = 0 V,		560		pF
C _{oss}	Output Capacitance	f = 1.0 MHz		140		pF
C _{rss}	Reverse Transfer Capacitance			55		pF
R _G	Gate Resistance	V _{GS} = 15 mV, f = 1.0 MHz		2.5		Ω

Switching Characteristics (Note 2)

t _{d(on)}	Turn-On Delay Time	V _{DD} = 15 V, I _D = 1 A,		7	14	ns
t _r	Turn-On Rise Time	V _{GS} = 10 V, R _{GEN} = 6 Ω		5	10	ns
t _{d(off)}	Turn-Off Delay Time			22	35	ns
t _f	Turn-Off Fall Time			3	6	ns
Q _g	Total Gate Charge	V _{DS} = 15 V, I _D = 8.4 A,		5.4	7.6	nC
Q _{gs}	Gate-Source Charge	V _{GS} = 5 V		1.7		nC
Q _{gd}	Gate-Drain Charge			1.9		nC

Drain-Source Diode Characteristics and Maximum Ratings

I _S	Maximum Continuous Drain-Source Diode Forward Current				2.1	A
V _{SD}	Drain-Source Diode Forward Voltage	V _{GS} = 0 V, I _S = 2.1 A (Note 2)		0.77	1.2	V
t _{rr}	Diode Reverse Recovery Time	I _F = 8.4 A, d _{I_F}/d_t = 100 A/μs}		19		ns
Q _{rr}	Diode Reverse Recovery Charge			9		nC

Notes:

- R_{θJA} is the sum of the junction-to-case and case-to-ambient thermal resistance where the case thermal reference is defined as the solder mounting surface of the drain pins. R_{θJC} is guaranteed by design while R_{θCA} is determined by the user's board design.



a) 50 °C/W when mounted on a 1 in² pad of 2 oz copper



b) 125 °C/W when mounted on a minimum pad.

Scale 1 : 1 on letter size paper

- Test: Pulse Width < 300 μs, Duty Cycle < 2.0%
- Starting T_J = 25°C, L = 1 mH, I_{AS} = 7 A, V_{DD} = 27V, V_{GS} = 10V

Typical Characteristics

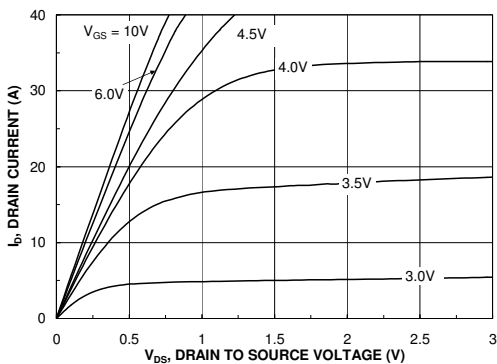

Figure 1. On-Region Characteristics.

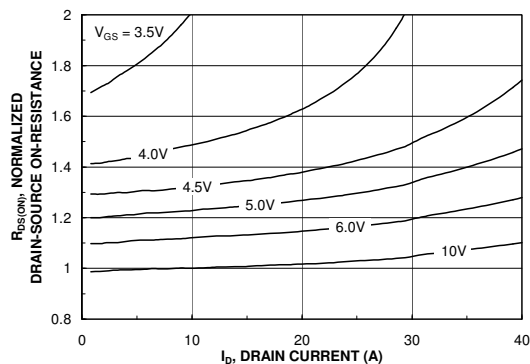

Figure 2. On-Resistance Variation with Drain Current and Gate Voltage.

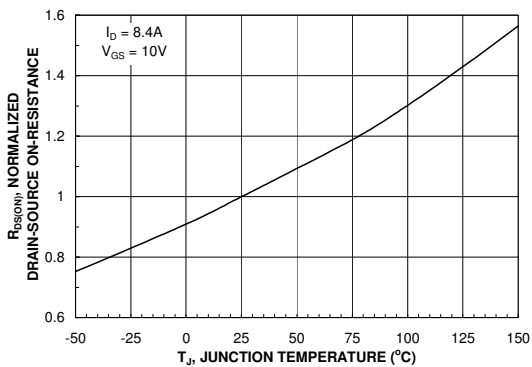

Figure 3. On-Resistance Variation with Temperature.

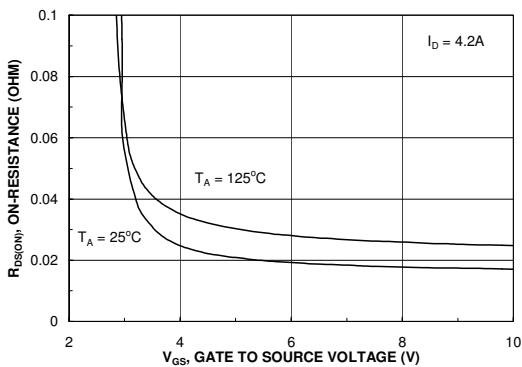

Figure 4. On-Resistance Variation with Gate-to-Source Voltage.

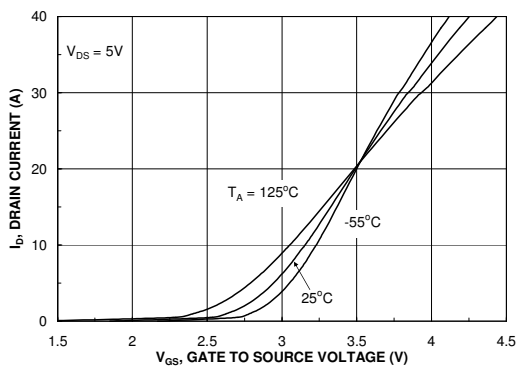

Figure 5. Transfer Characteristics.

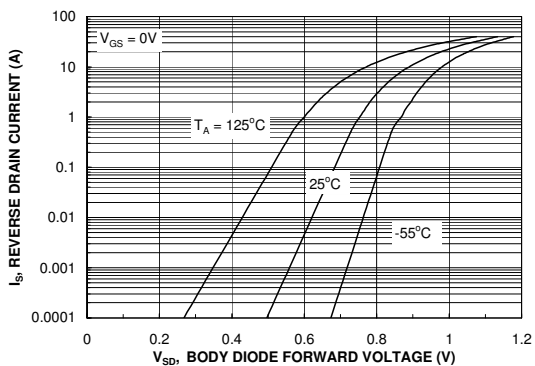

Figure 6. Body Diode Forward Voltage Variation with Source Current and Temperature.

Typical Characteristics

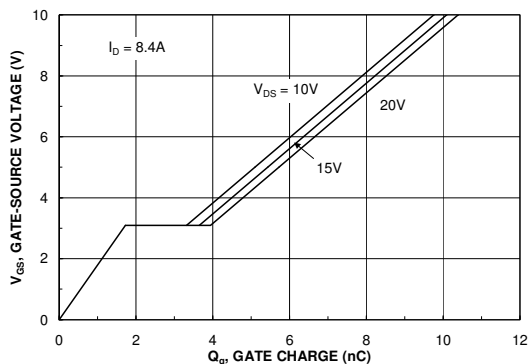

Figure 7. Gate Charge Characteristics.

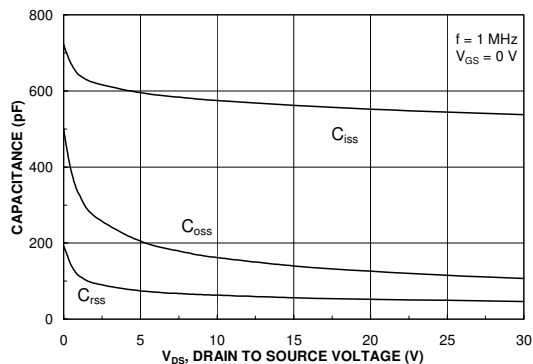

Figure 8. Capacitance Characteristics.

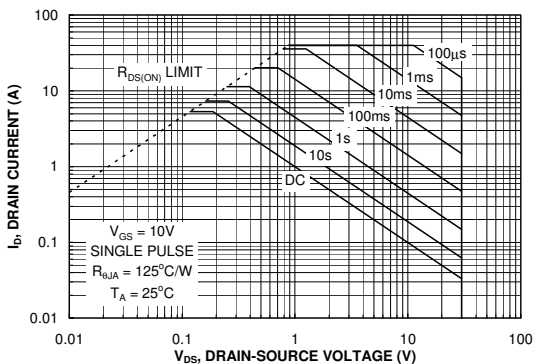

Figure 9. Maximum Safe Operating Area.

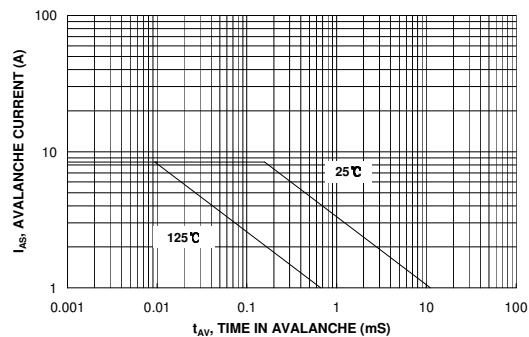

Figure 10. Unclamped Inductive Switching Capability

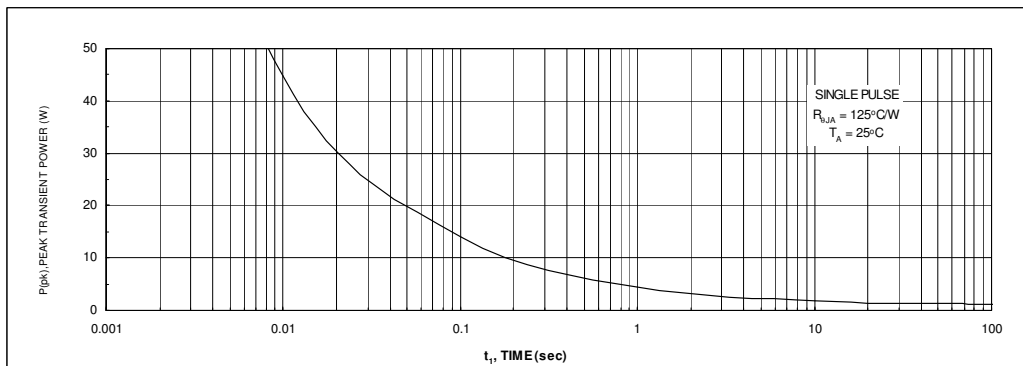

Figure 11. Single Pulse Maximum Power Dissipation.

Typical Characteristics

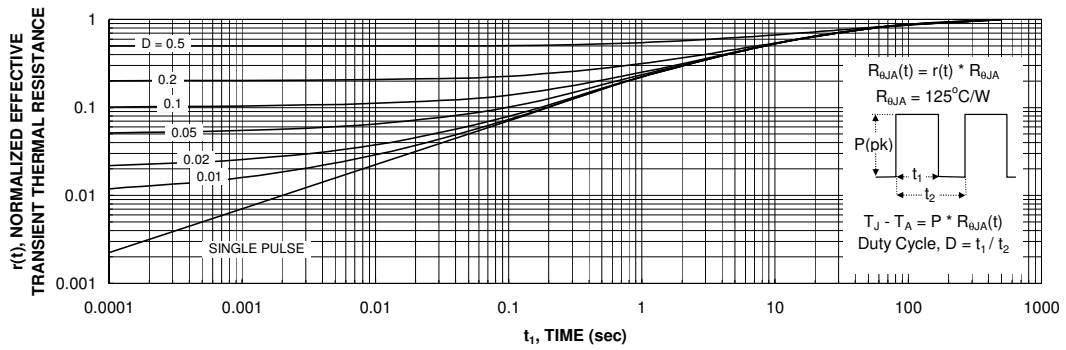

Figure 12. Transient Thermal Response Curve.

Thermal characterization performed using the conditions described in Note 1c.
 Transient thermal response will change depending on the circuit board design.

SPICE Thermal Model

```
.SUBCKT FDS6612A_THERM TH TL
*THERMAL MODEL SUBCIRCUIT
*REV A - JULY 2003
*MIN PAD RJA
```

CTHERM1	TH	8	0.005
CTHERM2	8	7	0.05
CTHERM3	7	6	0.10
CTHERM4	6	5	0.35
CTHERM5	5	4	0.45
CTHERM6	4	3	0.50
CTHERM7	3	2	0.55
CTHERM8	2	TL	3.00
RTHERM1	TH	8	5.000
RTHERM2	8	7	6.250
RTHERM3	7	6	7.500
RTHERM4	6	5	8.750
RTHERM5	5	4	10.625
RTHERM6	4	3	11.875
RTHERM7	3	2	31.250
RTHERM8	2	TL	43.750

```
.ENDS
```

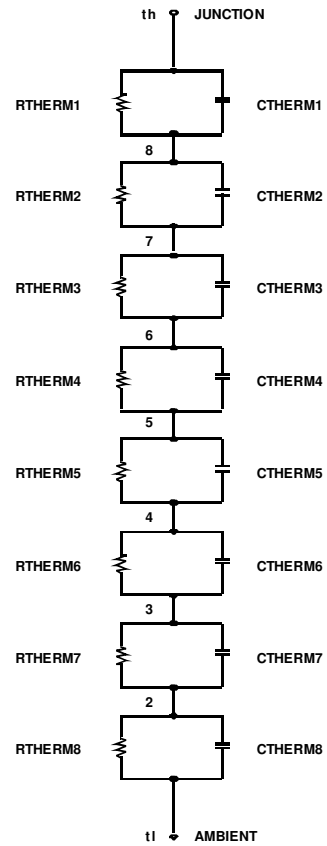

ON Semiconductor and  are trademarks of Semiconductor Components Industries, LLC dba ON Semiconductor or its subsidiaries in the United States and/or other countries. ON Semiconductor owns the rights to a number of patents, trademarks, copyrights, trade secrets, and other intellectual property. A listing of ON Semiconductor's product/patent coverage may be accessed at www.onsemi.com/site/pdf/Patent-Marking.pdf. ON Semiconductor reserves the right to make changes without further notice to any products herein. ON Semiconductor makes no warranty, representation or guarantee regarding the suitability of its products for any particular purpose, nor does ON Semiconductor assume any liability arising out of the application or use of any product or circuit, and specifically disclaims any and all liability, including without limitation special, consequential or incidental damages. Buyer is responsible for its products and applications using ON Semiconductor products, including compliance with all laws, regulations and safety requirements or standards, regardless of any support or applications information provided by ON Semiconductor. "Typical" parameters which may be provided in ON Semiconductor data sheets and/or specifications can and do vary in different applications and actual performance may vary over time. All operating parameters, including "Typicals" must be validated for each customer application by customer's technical experts. ON Semiconductor does not convey any license under its patent rights nor the rights of others. ON Semiconductor products are not designed, intended, or authorized for use as a critical component in life support systems or any FDA Class 3 medical devices or medical devices with a same or similar classification in a foreign jurisdiction or any devices intended for implantation in the human body. Should Buyer purchase or use ON Semiconductor products for any such unintended or unauthorized application, Buyer shall indemnify and hold ON Semiconductor and its officers, employees, subsidiaries, affiliates, and distributors harmless against all claims, costs, damages, and expenses, and reasonable attorney fees arising out of, directly or indirectly, any claim of personal injury or death associated with such unintended or unauthorized use, even if such claim alleges that ON Semiconductor was negligent regarding the design or manufacture of the part. ON Semiconductor is an Equal Opportunity/Affirmative Action Employer. This literature is subject to all applicable copyright laws and is not for resale in any manner.

PUBLICATION ORDERING INFORMATION

LITERATURE FULFILLMENT:

Literature Distribution Center for ON Semiconductor
19521 E. 32nd Pkwy, Aurora, Colorado 80011 USA
Phone: 303-675-2175 or 800-344-3860 Toll Free USA/Canada
Fax: 303-675-2176 or 800-344-3867 Toll Free USA/Canada
Email: orderlit@onsemi.com

N. American Technical Support: 800-282-9855 Toll Free
USA/Canada
Europe, Middle East and Africa Technical Support:
Phone: 421 33 790 2910
Japan Customer Focus Center
Phone: 81-3-5817-1050

ON Semiconductor Website: www.onsemi.com
Order Literature: <http://www.onsemi.com/orderlit>
For additional information, please contact your local
Sales Representative