



Common Mode Filters

For high-speed differential signal line, general signal line

ACM series

ACM2012

[0805 inch]*

ACM2520

[1008 inch]

* Dimensions Code JIS[EIA]

REMINDERS FOR USING THESE PRODUCTS

Before using these products, be sure to request the delivery specifications.

SAFETY REMINDERS

Please pay sufficient attention to the warnings for safe designing when using these products.

REMINDERS

- The storage period is less than 6 months. Be sure to follow the storage conditions (Temperature: 5 to 40°C, Humidity: 10 to 75% RH or less).
If the storage period elapses, the soldering of the terminal electrodes may deteriorate.
- Do not use or store in locations where there are conditions such as gas corrosion (salt, acid, alkali, etc.).
- Before soldering, be sure to preheat components.
The preheating temperature should be set so that the temperature difference between the solder temperature and chip temperature does not exceed 150°C.
- Soldering corrections after mounting should be within the range of the conditions determined in the specifications.
If overheated, a short circuit, performance deterioration, or lifespan shortening may occur.
- When embedding a printed circuit board where a chip is mounted to a set, be sure that residual stress is not given to the chip due to the overall distortion of the printed circuit board and partial distortion such as at screw tightening portions.
- Self heating (temperature increase) occurs when the power is turned ON, so the tolerance should be sufficient for the set thermal design.
- Carefully lay out the coil for the circuit board design of the non-magnetic shield type.
A malfunction may occur due to magnetic interference.
- Use a wrist band to discharge static electricity in your body through the grounding wire.
- Do not expose the products to magnets or magnetic fields.
- Do not use for a purpose outside of the contents regulated in the delivery specifications.
- The products listed on this catalog are intended for use in general electronic equipment (AV equipment, telecommunications equipment, home appliances, amusement equipment, computer equipment, personal equipment, office equipment, measurement equipment, industrial robots) under a normal operation and use condition.
The products are not designed or warranted to meet the requirements of the applications listed below, whose performance and/or quality require a more stringent level of safety or reliability, or whose failure, malfunction or trouble could cause serious damage to society, person or property.
If you intend to use the products in the applications listed below or if you have special requirements exceeding the range or conditions set forth in the each catalog, please contact us.

(1) Aerospace/Aviation equipment
 (2) Transportation equipment (cars, electric trains, ships, etc.)
 (3) Medical equipment
 (4) Power-generation control equipment
 (5) Atomic energy-related equipment
 (6) Seabed equipment
 (7) Transportation control equipment

(8) Public information-processing equipment
 (9) Military equipment
 (10) Electric heating apparatus, burning equipment
 (11) Disaster prevention/crime prevention equipment
 (12) Safety equipment
 (13) Other applications that are not considered general-purpose applications

When designing your equipment even for general-purpose applications, you are kindly requested to take into consideration securing protection circuit/device or providing backup circuits in your equipment.

Product compatible with RoHS directive
Compatible with lead-free solders

Common Mode Filters

For high-speed differential signal line, general signal line

Overview of the ACM Series

FEATURES

- Downsized wound type chip common mode filter that maintains required common mode filter characteristics. Impedance for common mode noise can clear 1000Ω [100MHz], and has excellent EMC suppression.
- Differential mode impedance is suppressed, so there is virtually no affect on high speed signals.
- There is a two-line type and a three-line type, so they can be used for various circuits and noise.

APPLICATION

- Common mode noise countermeasure for high-speed differential signals where influence to the signal is a concern.
- USB line for PCs and peripheral devices.
- IEEE1394 lines and ETHERNET lines for PCs, STBs, etc.
- LCD panel LVDS and Panel Link lines.

PART NUMBER CONSTRUCTION

ACM	2012	-	900	-	2P	-	T	-	002
Series name	LxWxH Dimensions (mm)		Impedance (Ω) at 100MHz		Number of lines		Packaging style		Internal code
	2012	2.0x1.2x1.3	900	90	2P	2 lines	T	ø180mm reel	
	2520	2.5x2.0x1.2	201	200	3P	3 lines	TL	ø330mm reel	
			102	1000					

OPERATING TEMPERATURE RANGE, PACKAGE QUANTITY, PRODUCT WEIGHT

Type	Temperature range		Reel diameter (mm)	Package quantity (pieces/reel)	Individual weight (mg)
	Operating temperature (°C)	Storage temperature* (°C)			
	ACM2012	-40 to +85			
ACM2520	-40 to +85	-40 to +85	ø330	10,000	25
			ø180	2,000	
			ø330	10,000	

* The Storage temperature range is for after the circuit board is mounted.

○ RoHS Directive Compliant Product: See the following for more details related to RoHS Directive compliant products. <http://www.tdk.co.jp/rohs/>

• All specifications are subject to change without notice.

Overview of the ACM Series

RECOMMENDED REFLOW PROFILE

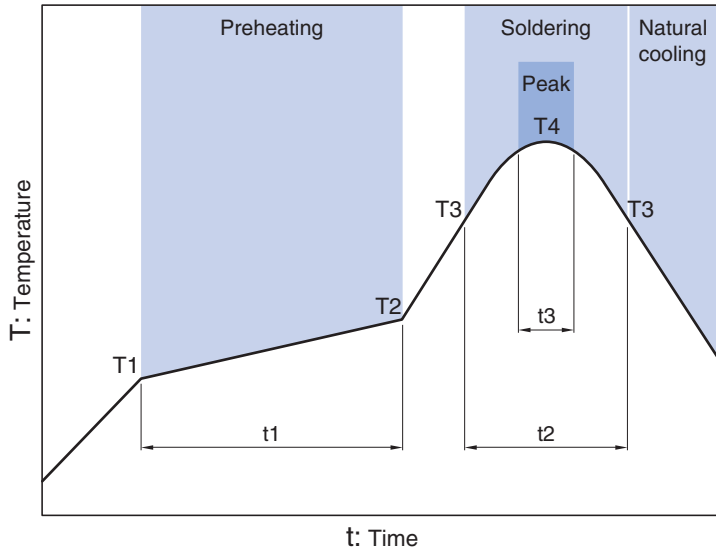

Preheating			Soldering		Peak	
Temp.	Temp.	Time	Temp.	Time	Temp.	Time
T1	T2	t1	T3	t2	T4	t3
150°C	180°C	60 to 120s	230°C	10 to 30s	245°C	5s

• All specifications are subject to change without notice.

ACM series

ACM2012 Type



SHAPE & DIMENSIONS

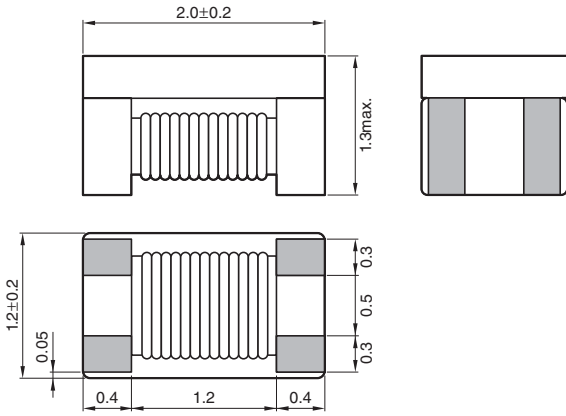

Dimensions in mm

RECOMMENDED LAND PATTERN

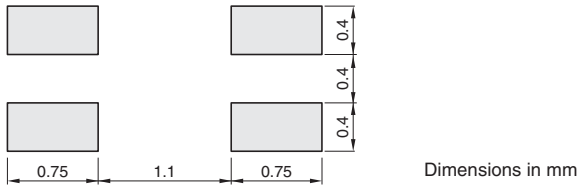

Dimensions in mm

CIRCUIT DIAGRAM

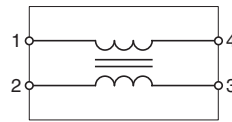

• No polarity

ACM series **ACM2012 Type**

■ ELECTRICAL CHARACTERISTICS

□ CHARACTERISTICS SPECIFICATION TABLE

Impedance (Ω) [100MHz]		DC resistance (Ω) max. [per line]	Rated voltage (V) max.	Rated current (A) max.	Part No.
min.	typ.				
65	90	0.19	50	0.4	ACM2012-900-2P-T002
90	120	0.22	50	0.37	ACM2012-121-2P-T002
150	200	0.25	50	0.35	ACM2012-201-2P-T002
270	360	0.5	50	0.22	ACM2012-361-2P-T002

○ Measurement equipment

Measurement item	Product No.	Manufacturer
Common mode impedance	4991A	Agilent Technologies
DC resistance	4338A	Agilent Technologies
Insulation resistance	4339A	Agilent Technologies

* Equivalent measurement equipment may be used.

□ IMPEDANCE VS. FREQUENCY CHARACTERISTICS

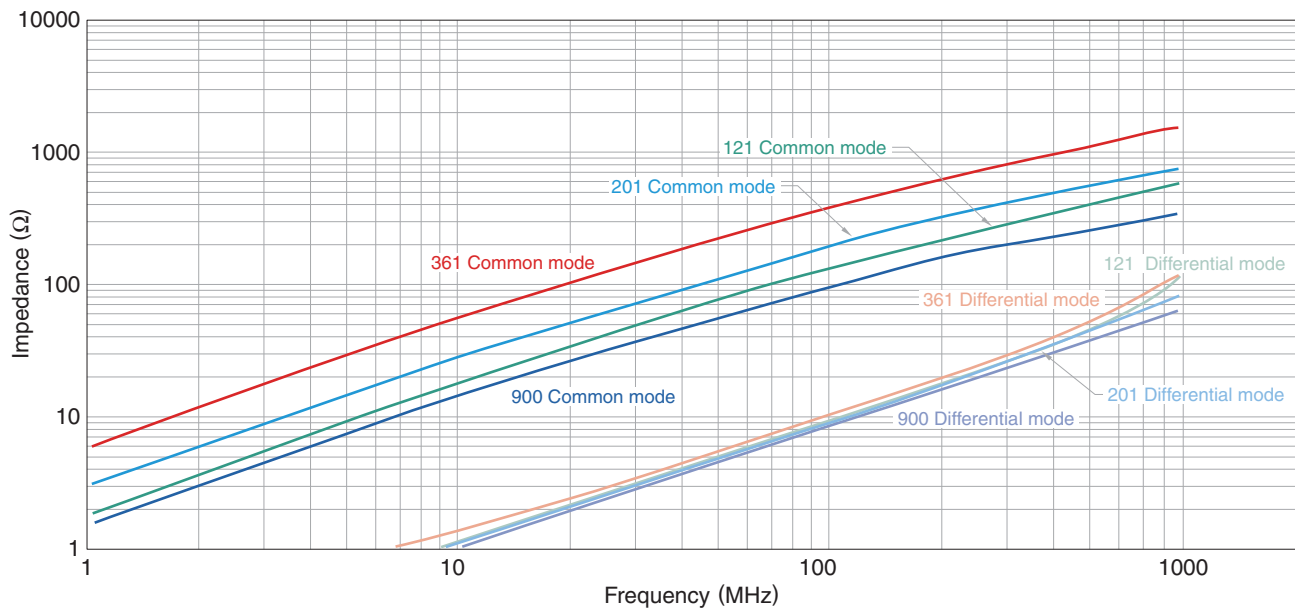

○ Measurement equipment

Product No.	Manufacturer
4991A	Agilent Technologies

* Equivalent measurement equipment may be used.

ACM series

ACM2520-2P Type



SHAPE & DIMENSIONS

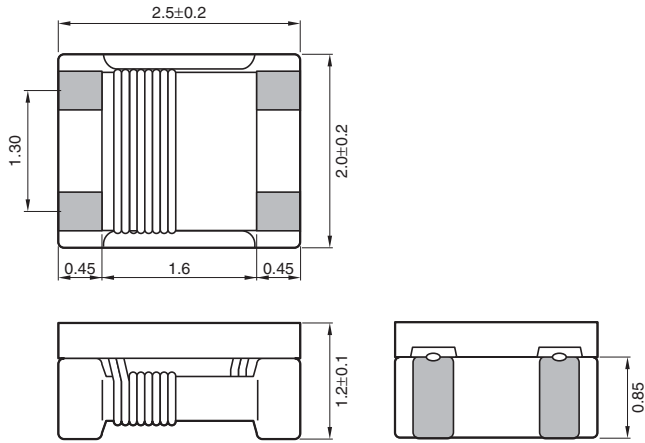

Dimensions in mm

RECOMMENDED LAND PATTERN

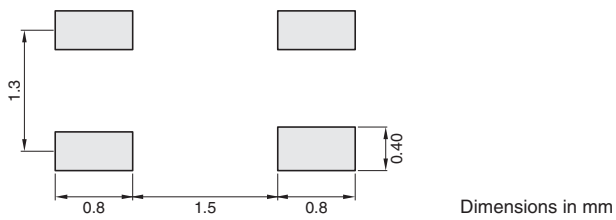

Dimensions in mm

CIRCUIT DIAGRAM

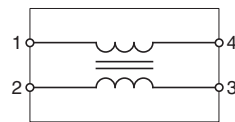

• No polarity

ACM series **ACM2520-2P Type**

■ ELECTRICAL CHARACTERISTICS

□ CHARACTERISTICS SPECIFICATION TABLE

Impedance (Ω) [100MHz]		DC resistance (Ω)max.[per line]	Rated voltage (V)max.	Rated current (A)max.	Part No.
min.	typ.				
225	300	0.35	20	0.4	ACM2520-301-2P-T002
330	450	0.4	20	0.35	ACM2520-451-2P-T002
450	600	0.45	20	0.3	ACM2520-601-2P-T002
750	1000	0.9	20	0.2	ACM2520-102-2P-T002

○ Measurement equipment

Measurement item	Product No.	Manufacturer
Common mode impedance	4991A	Agilent Technologies
DC resistance	4338A	Agilent Technologies
Insulation resistance	4339A	Agilent Technologies

* Equivalent measurement equipment may be used.

□ IMPEDANCE VS. FREQUENCY CHARACTERISTICS

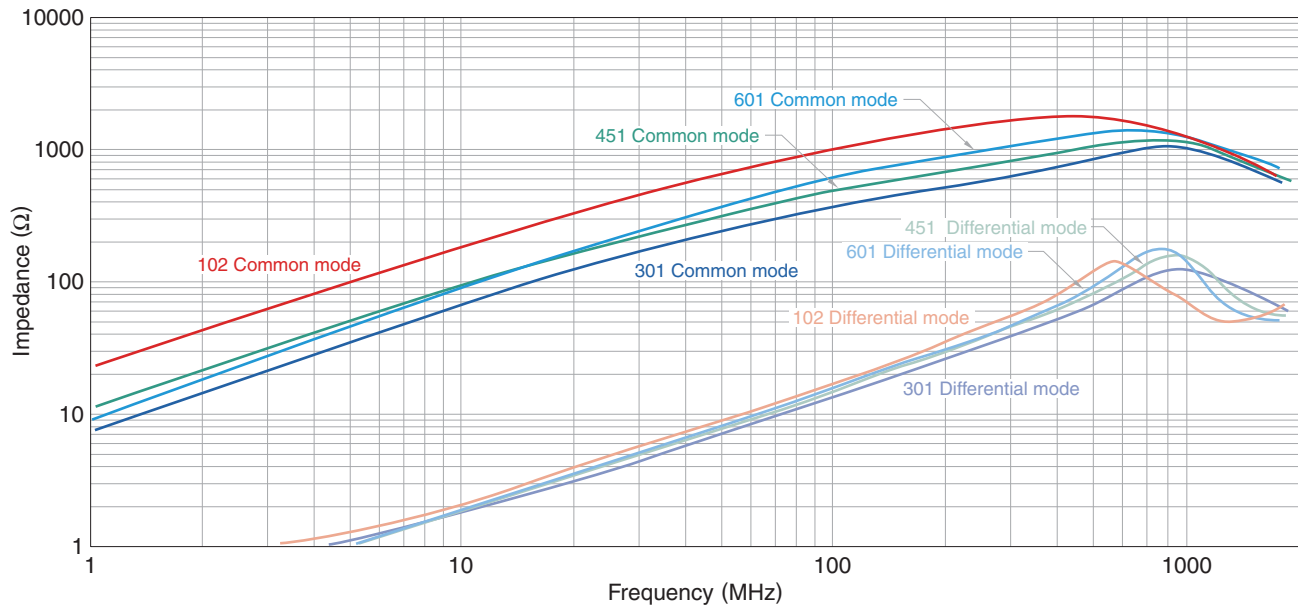

○ Measurement equipment

Product No.	Manufacturer
4991A	Agilent Technologies

* Equivalent measurement equipment may be used.

ACM series

ACM2520-3P Type



SHAPE & DIMENSIONS

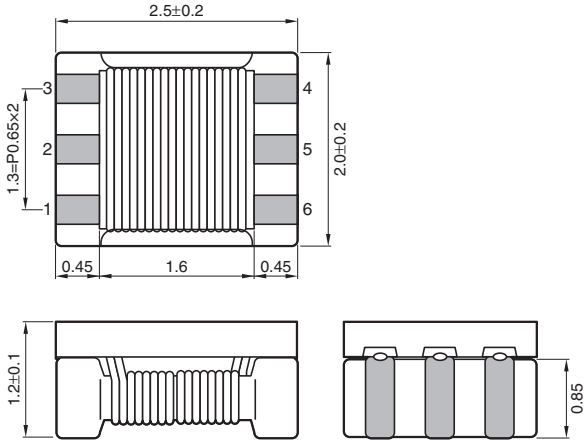

Dimensions in mm

RECOMMENDED LAND PATTERN

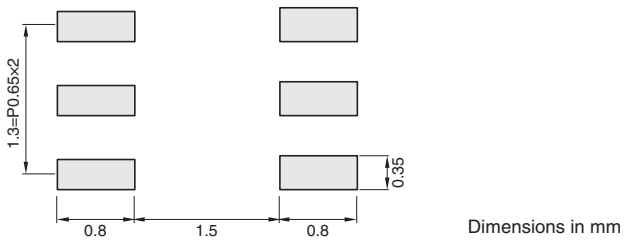

Dimensions in mm

CIRCUIT DIAGRAM

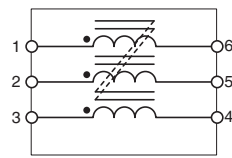

• No polarity

• All specifications are subject to change without notice.

ACM series **ACM2520-3P Type**

■ ELECTRICAL CHARACTERISTICS

□ CHARACTERISTICS SPECIFICATION TABLE

Impedance (Ω) [100MHz]		DC resistance (Ω)max.[per line]	Rated voltage (V)max.	Rated current (A)max.	Part No.
min.	typ.				
600	800	1.6	20	0.15	ACM2520-801-3P-T002

○ Measurement equipment

Measurement item	Product No.	Manufacturer
Common mode impedance	4991A	Agilent Technologies
DC resistance	4338A	Agilent Technologies
Insulation resistance	4339A	Agilent Technologies

* Equivalent measurement equipment may be used.

□ IMPEDANCE VS. FREQUENCY CHARACTERISTICS

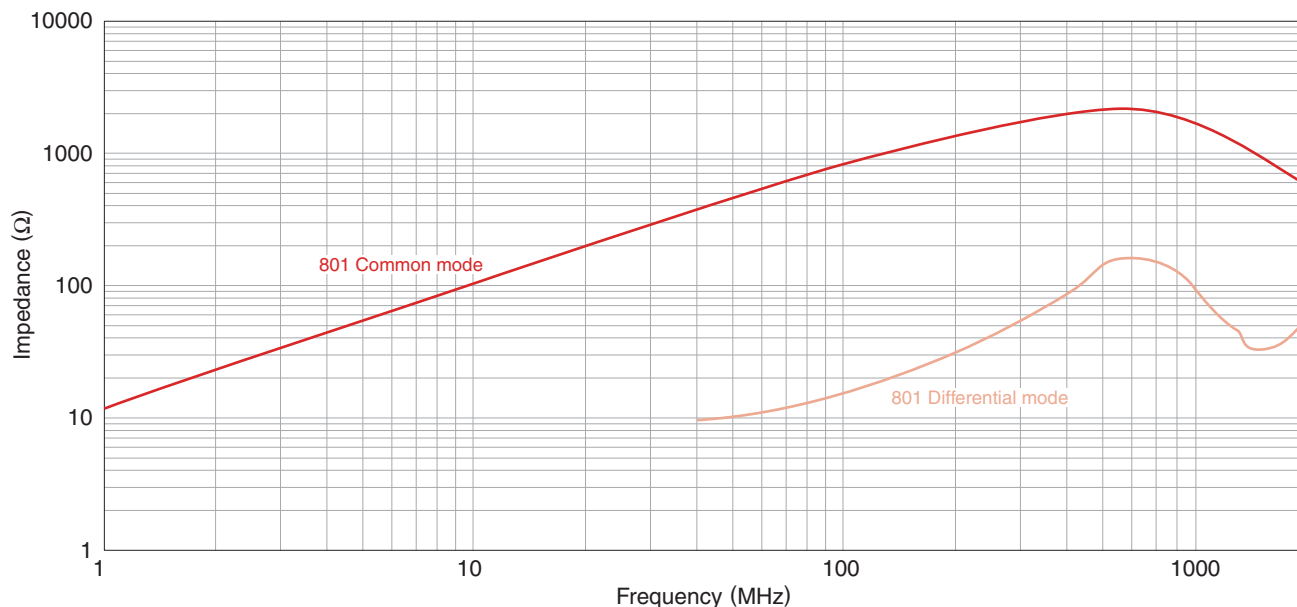

○ Measurement equipment

Product No.	Manufacturer
4991A	Agilent Technologies

* Equivalent measurement equipment may be used.

• All specifications are subject to change without notice.

ACM series

Packaging style

REEL DIMENSIONS

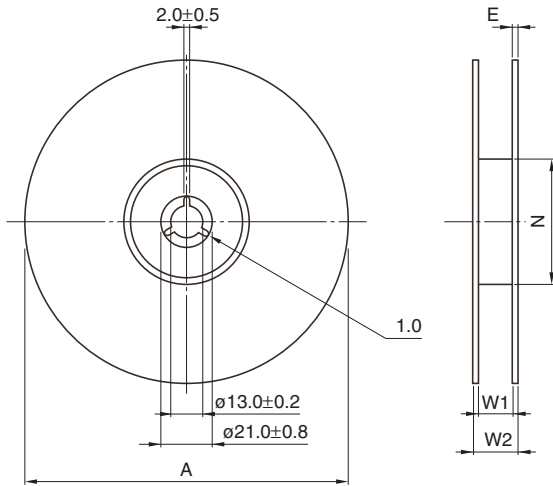

Dimensions in mm

Type	A	W1	W2	N	E
ACM2012	$\phi 330 \pm 2$	9.5 ± 0.5	13.5 ± 1	100 ± 1	2 typ.
	$\phi 180 \pm 3$	$9+1/-0$	13 ± 1	$60+1/-0$	2 typ.
ACM2520	$\phi 330 \pm 2$	9.5 ± 0.5	13.5 ± 1	100 ± 1	2 typ.
	$\phi 180 \pm 3$	$9+1/-0$	13 ± 1	$60+1/-0$	2 typ.

TAPE DIMENSIONS

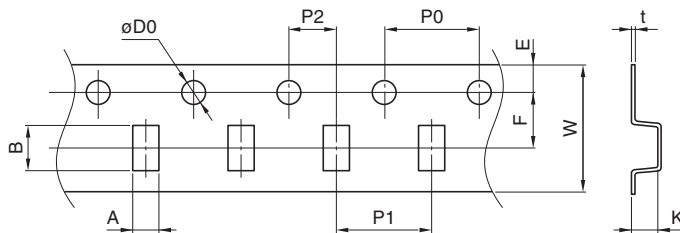

Dimensions in mm

Type	A	B	$\phi D0$	E	F	P0	P1	P2	W	K	t
ACM2012	1.4 ± 0.1	2.25 ± 0.1	$1.5+0.1/0$	1.75 ± 0.1	3.5 ± 0.1	4.0 ± 0.1	4.0 ± 0.1	2.0 ± 0.1	8.0 ± 0.2	1.4 ± 0.1	0.25 ± 0.05
ACM2520	2.4 ± 0.1	2.9 ± 0.1	$1.5+0.1/0$	1.75 ± 0.1	3.5 ± 0.1	4.0 ± 0.1	4.0 ± 0.1	2.0 ± 0.1	8.0 ± 0.2	1.45 ± 0.1	0.25 ± 0.05

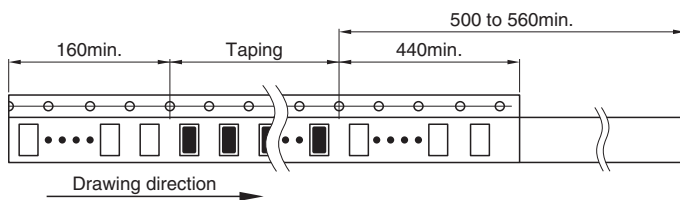

Dimensions in mm

• All specifications are subject to change without notice.

Mouser Electronics

Authorized Distributor

Click to View Pricing, Inventory, Delivery & Lifecycle Information:

[TDK:](#)

[ACM3225-102-2P-T](#) [ACM3225-800-2P](#) [ACM3225-161-2P](#) [ACM3225-271-2P](#)